

SKY73101: 1800-1990 MHz High Performance VCO/Synthesizer With Integrated Switch

Applications

- 2G, 2.5G, and 3G base station transceivers:
 - GSM, EDGE, CDMA, WCDMA
- General purpose RF systems

Features

- Wideband frequency operation: 1800 to 1990 MHz
- Process-tolerant compensation for VCO
- 24-bit $\Sigma\Delta$ fractional-N synthesizer
- Ultra-fine frequency resolution of 0.001 ppm
- Flexible reference frequency selection
- Three-wire serial interface up to 20 MHz clock frequency
- Integrated PLL supply regulation for spur isolation
- MCM (38-pin, 9 x 12 mm) Pb-free free (MSL3, 260 °C per JEDEC J-STD-020) SMT package

NEW

Skyworks offers lead (Pb)-free, RoHS (Restriction of Hazardous Substances) compliant packaging.



Description

Skyworks SKY73101 Voltage-Controlled Oscillator (VCO)/Synthesizer is a fully integrated, high performance signal source for high dynamic range transceivers. The device provides ultra-fine frequency resolution, fast switching speed, and low phase noise performance for 2G, 2.5G, and 3G base station transceivers.

The SKY73101 VCO/Synthesizer is a key building block for high-performance radio system designs that require low power and a fine step size. Reference clock generators with an output frequency up to 52 MHz can be used with the SKY73101. The input clock frequency is divided down by programmable dividers (1 to 8) for the synthesizer. The phase detector can operate at a maximum speed of 26 MHz, which allows better phase noise due to the lower division value.

The SKY73101 VCO/Synthesizer is provided in a compact, 38-pin Multi-Chip Module (MCM). The device package and pinout are shown in Figure 1. A functional block diagram is shown in Figure 2. Signal pin assignments and functional pin descriptions are provided in Table 1.

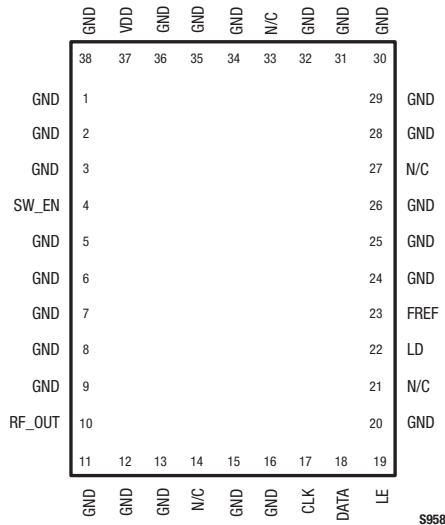
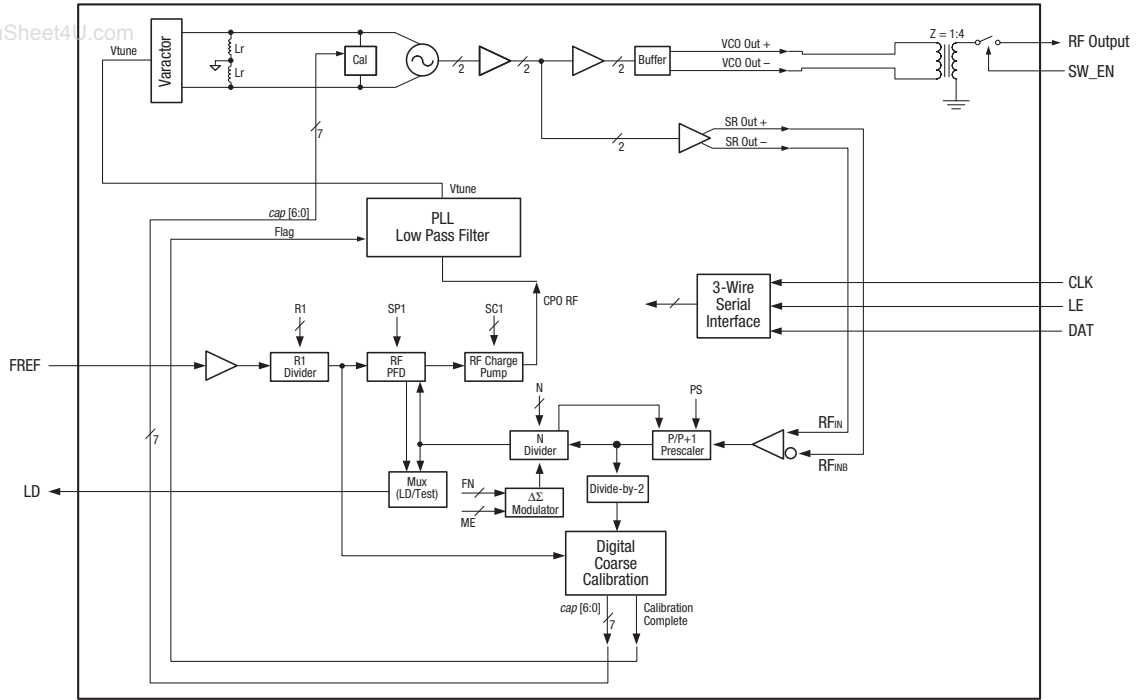

Figure 1. SKY73101 Pinout– 38-Pin MCM Package (Top View)

PRELIMINARY DATA SHEET • SKY73101 VCO/SYNTHESIZER

www.DataSheet4U.com



S1040

Figure 2. SKY73101 Functional Block Diagram

Table 1. SKY73101 Signal Descriptions

Pin #	Name	Description	Pin #	Name	Description
1	GND	Ground	20	GND	Ground
2	GND	Ground	21	N/C	No connection
3	GND	Ground	22	LD	Lock detect output
4	SW_EN	Synthesizer RF output switch enable	23	FREF	Frequency reference input
5	GND	Ground	24	GND	Ground
6	GND	Ground	25	GND	Ground
7	GND	Ground	26	GND	Ground
8	GND	Ground	27	N/C	No connection
9	GND	Ground	28	GND	Ground
10	RF_OUT	Synthesizer output	29	GND	Ground
11	GND	Ground	30	GND	Ground
12	GND	Ground	31	GND	Ground
13	GND	Ground	32	GND	Ground
14	N/C	No connection	33	N/C	No connection
15	GND	Ground	34	GND	Ground
16	GND	Ground	35	GND	Ground
17	CLK	Serial port clock	36	GND	Ground
18	DATA	Serial port data	37	VDD	+5 V power supply
19	LE	Serial port latch enable	38	GND	Ground

Technical Description

The SKY73101 is a fractional-N frequency synthesizer using a $\Sigma\Delta$ modulation technique. The fractional-N implementation provides low in-band noise by having a low division and fast frequency settling time. The device also provides programmable, arbitrary fine frequency resolution. This compensates the frequency synthesizer for crystal frequency drift.

Serial I/O Control Interface

The SKY73101 is programmed through a three-wire serial bus control interface using four 26-bit words. The three-wire interface consists of three signals: CLK (pin 17), LE (pin 19), and the bit serial data line DATA (pin 18). The convention is to load data from the most significant bit to the least significant bit (MSB to LSB). A serial data input timing diagram is shown in Figure 3. Preset timing parameter values are provided in Table 2.

Figure 4 depicts the serial bus, which consists of one 26-bit load register and four separate 24-bit registers. Data is initially clocked into the load register starting with the MSB and ending with the LSB. The LE signal is used to gate the clock to the load register, requiring the LE signal to be brought low before the data load. Data is shifted on the rising edge of CLK.

The two final LSBs are decoded to determine which holding register should latch the data. The falling edge of LE latches the data into the appropriate holding register. This programming sequence must be repeated to fill all four holding registers.

Loading new data into a holding register not associated with the synthesizer frequency programming does not reset or change the synthesizer. The synthesizer should not lose lock before, during, or after a new serial word load that does not change the programmed frequency.

VCO Tuning Loop

A VCO auto-tuning loop provides the proper 7-bit coarse tuning setting for the VCO switch capacitors in the VCO output. This sets the oscillation frequency as close to target as possible before starting fine analog tuning.

The auto-tuning loop is designed to compensate process variation so that the VCO fine tuning range can be reduced to cover temperature variation only. It significantly reduces VCO gain (Kv) which reduces VCO phase noise.

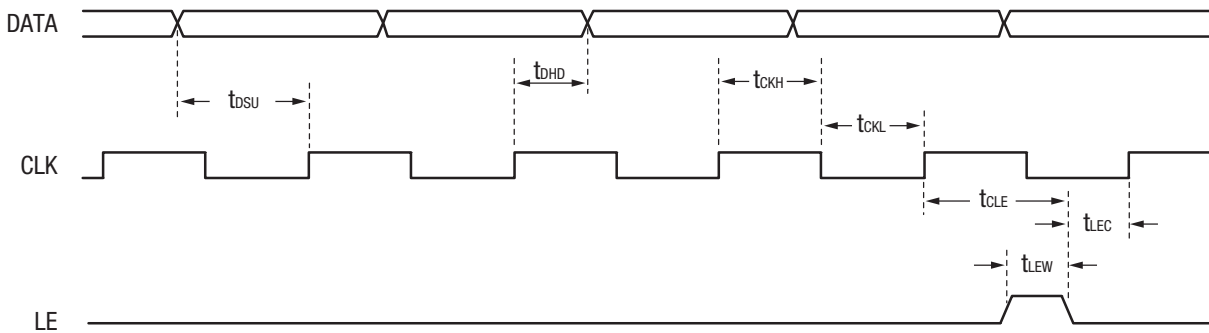

S1053

Figure 3. SKY73101 Serial Data Input Timing Diagram (MSB First)

Table 2. CLK, DATA, LE Preset Timing Parameters

Parameter	Value
Input high voltage (V _{IH})	1.6 V
Input low voltage (V _{IL})	0.3 V
Input current (I _{DIG})	1 μA (maximum)
Clock frequency	15 MHz (maximum)
Clock high (t _{CKH})	15 ns (minimum)
Clock low (t _{CKL})	15 ns (minimum)
Data set up (t _{DSU})	20 ns (minimum)
Data hold (t _{DH})	10 ns (minimum)
Clock to latch enable (t _{CLE})	20 ns (minimum)
Latch enable width (t _{LEW})	15 ns (minimum)
Latch enable to clock (t _{LEC})	15 ns (minimum)
Word length	26 bits
Number of words	4
Current drain	2 μA

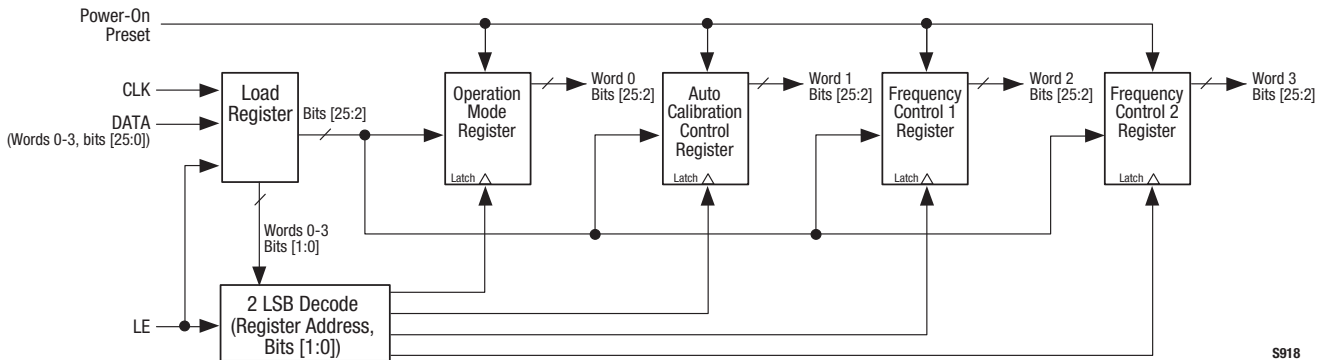

Figure 4. Serial Bus Block Diagram

VCO Prescalers

The VCO prescalers divide the VCO output signal by either 16/17 or 8/9. The $\Sigma\Delta$ modulator determines whether to divide by 16 or 17 in the 16/17 mode, or whether to divide by 8 or 9 in the 8/9 mode.

N-Counter

The N-counter consists of two asynchronous ripple counters, a 6-bit M-counter and a 4-bit A-counter. The M-counter determines the counts using the lower division ratio in the prescaler (8 or 16); the A-counter determines the counts using the upper division ratio (9 or 17).

By changing the counter setting at each reference clock cycle, the Modulated Fractional Divider (MFD) achieves the desired noise shaping.

VCO MFD Block

The MFD block divides down the prescaler output to the Phase Locked Loop (PLL) reference frequency. A third order cascaded $\Sigma\Delta$ modulation technique minimizes spurs through randomization of the division ratio.

The MFD block controls the division ratio by dynamically programming the M and A counters in the N-counter.

Phase Detector and Charge Pump

The phase detector and charge pump detect and integrate the phase and frequency errors of the divided down VCO output versus the reference clock. This results in a feedback adjustment of the control voltage for the VCO.

Lock Detect

Lock detection circuitry provides a CMOS logic level indication when the PLL is frequency locked (high when locked).

Reference Input Divider

The R-counter (reference input clock divider) consists of three divide-by-two blocks and one multiplexer controlled by the RDIV[1:0] parameter in Legacy Word 2. The R-counter is used to select a divide-by-one to a divide-by-eight function.

Synthesizer Output Switch

An on-chip switch is integrated into the SKY73101 RF output after the balun and is controlled by the SW_EN signal (pin 4) as indicated below:

SW_EN Input	Synthesizer Output
High	On
Low	Off

The switch provides >50 dB isolation at the synthesizer RF output. This allows the SKY73101 to be used for GSM applications.

Synthesizer Programming

To program the synthesizer to the correct frequency, values for the N-counter (both M and A portions), fractional divisor (FN), and fractional modulus extender (ME) are needed. These values are used to determine the total divider ratio, D_{Total} , according to Equation 1:

$$D_{Total} = N_{actual} + FN_{actual} + ME_{actual} + 3.5 \quad (1)$$

Where: N_{actual} = the actual value of the N-counter

FN_{actual} = the actual fractional divisor

ME_{actual} = the actual fractional modulus extender

Because of the way the $\Delta\Sigma$ modulator is implemented in the SKY73103, the number 3.5 must be added to the division number to obtain the final division ratio.

The calculated value for D_{Total} can then be used to determine the correct synthesizer frequency, RF :

$$RF = \frac{F_{REF}}{R1} \times D_{Total} \quad (2)$$

Where: F_{REF} = the reference frequency

$R1$ = the reference divider ratio

The 6-bit M-counter and the 4-bit A-counter portions of the N-counter are calculated according to the following relationships:

N_{actual} is the actual N-counter value and is the integer portion of $(D_{Total} - 3.5)$:

$$N_{actual} = M_{actual} \times P + A_{actual} \quad (3)$$

If: $M = M_{actual}$ (binary number, fit to six bits)

$A = A_{actual}$ (binary number, fit to four bits)

Then: $N = M \times 2^4 + A$

Where: N is the number to be programmed into the N-counter.

The synthesizer has a selectable prescaler of 8/9 or 16/17. If the 16/17 prescaler is used:

$$P = 2^4 = 16$$

In this case, N is the same as N_{actual} , M is equal to the six MSBs of N_{actual} , and A is equal to the four LSBs of N_{actual} .

If the 8/9 prescaler is used:

$$P = 8$$

Here, N is not equal to N_{actual} . The A-counter portion only uses the three LSBs (the 4th bit of the A-counter is a “don’t care” bit).

The fractional divisor code (FN) sets the fractional-N modulo up to 256 modulo according to the following equation:

$$FN_{actual} = D_7 \left(\frac{1}{2}\right) + D_6 \left(\frac{1}{2^2}\right) + D_5 \left(\frac{1}{2^3}\right) + \dots + D_0 \left(\frac{1}{2^8}\right) \quad (4)$$

The value of FN is equal to the binary representation of 256 (or 2^8) $\times FN_{actual}$, or:

$$FN = D_7 \times 2^7 + D_6 \times 2^6 + D_5 \times 2^5 + \dots D_0$$

The fractional modulo can be extended up to 2^{23} using the modulo extender (ME) if required:

$$ME_{actual} = D_{14}(1/2^9) + D_{13}(1/2^{10}) + D_{12}(1/2^{11}) + \dots + D_0(1/2^{23})$$

The value of ME is equal to the binary representation of the integer part of $2^{23} \times ME_{actual}$, or:

$$ME = D_{14} \times 2^{14} + D_{13} \times 2^{13} + D_{12} \times 2^{12} + \dots D_0$$

Example 1:

A desired synthesizer frequency of 2640.45 MHz is required using a crystal frequency of 16 MHz and a 16/17 prescaler. Since the maximum internal reference frequency is 25 MHz, the crystal frequency does not need to be divided. However, a reference divider ratio of 2 is used for this example.

Restating Equation 2 as a function of D_{Total} :

$$D_{Total} = (2640.45 \times 2)/16 = 330.05625$$

Where: $RF = 2640.45$

$$R1 = 2$$

$$F_{REF} = 16$$

Determine N_{actual} by subtracting 3.5 from D_{Total} and removing the fractional portion:

$$D_{Total} - 3.5 = 326.55625$$

Using Equation 3:

$$N_{actual} = 326 = M_{actual} \times P + A_{actual}$$

Where: $M_{actual} = 20$

$$P = 16$$

$$A_{actual} = 6$$

$M = M_{actual} = 20 = 010100b$ (the six MSBs)

$A = A_{actual} = 6 = 0110b$ (the four LSBs)

$N = M \times 2^4 + A = 0101000110b$ (this is the same as N_{actual})

Multiply the fractional portion that was removed in the previous step by 256 and remove the fractional portion of the result to determine FN :

$$0.55625 \times 256 = 142.4$$

$$FN = 142 = 10001110b$$

Divide FN by 256 to determine the actual fractional part, FN_{actual} :

$$FN_{actual} = 142/256 = 0.5546875$$

Subtract this result from the fractional portion of $(D_{Total} - 3.5)$ to determine the actual fractional modulus extender, ME_{actual} :

$$\begin{aligned} ME_{actual} &= (D_{Total} - 3.5 - N_{actual}) - FN_{actual} \\ &= 0.55625 - 0.5546875 \\ &= 0.0015625 \end{aligned}$$

Multiply this result by 8388608 (the 23-bit $\Delta\Sigma$ modulator value, 2^{23}) and remove the fractional portion to determine the value of ME :

$$0.0015625 \times 8388608 = 13107.2$$

$$ME = 13107 = 011001100110011b$$

Example 2:

A desired synthesizer frequency of 725 MHz is required using a crystal frequency of 13 MHz and an 8/9 prescaler. Since the maximum internal reference frequency is 25 MHz, the crystal frequency does not need to be divided. However, a reference divider ratio of 2 is used for this example.

Restating Equation 2 as a function of D_{Total} :

$$D_{Total} = (725 \times 2)/13 = 111.538461538$$

Where: $RF = 725$

$$R1 = 2$$

$$F_{REF} = 13$$

Determine N_{actual} by subtracting 3.5 from D_{Total} and removing the fractional portion:

$$D_{Total} - 3.5 = 108.038461538$$

Using Equation 3:

$$N_{actual} = 108 = M_{actual} \times P + A_{actual}$$

Where: $M_{actual} = 13$

$$P = 8$$

$$A_{actual} = 4$$

$M = M_{actual} = 13 = 001101b$ (the six MSBs)

$A = A_{actual} = 4 = 0100b$ (the four LSBs)

$N = M \times 2^4 + A = 0011010100b$ (the value programmed)

Multiply the fractional portion that was removed in the previous step by 256 and remove the fractional portion of the result to determine FN :

$$0.038461538 \times 256 = 9.846153728$$

$$FN = 9 = 00001001b$$

Divide FN by 256 to determine the actual fractional part, FN_{actual} :

$$FN_{actual} = 9/256 = 0.03515625$$

Subtract this result from the fractional portion of $(D_{Total} - 3.5)$ to determine the actual fractional modulus extender, ME_{actual} :

$$\begin{aligned} ME_{actual} &= (D_{Total} - 3.5 - N_{actual}) - FN_{actual} \\ &= 0.038461538 - 0.03515625 \\ &= 0.003305288 \end{aligned}$$

Multiply this result by 8388608 (the 23-bit $\Delta\Sigma$ modulator value, 2^{23}) and remove the fractional portion to determine the value of ME :

$$0.003305288 \times 8388608 = 27726.7653$$

$$ME = 27726 = 110110001001110b$$

Package and Handling Information

Since the device package is sensitive to moisture absorption, it is baked and vacuum packed before shipping. Instructions on the shipping container label regarding exposure to moisture after the container seal is broken must be followed. Otherwise, problems related to moisture absorption may occur when the part is subjected to high temperature during solder assembly.

The SKY73101 is rated to Moisture Sensitivity Level 3 (MSL3) at 260 °C. It can be used for lead or lead-free soldering. For additional information, refer to Skyworks Application Note, *PCB Design and SMT Assembly/Rework Guidelines for MCM-L Packages*, document number 101752.

Care must be taken when attaching this product, whether it is done manually or in a production solder reflow environment. Production quantities of this product are shipped in a standard

tape and reel format. For packaging details, refer to the Skyworks Application Note, *Tape and Reel*, document number 101568.

Circuit Design Considerations

The following design considerations are general in nature and must be followed regardless of final use or configuration

1. Paths to ground should be made as short and as low impedance as possible.
2. The ground pad of the SKY73101 provides critical electrical grounding requirements. Design the connection to the ground pad to provide the best electrical connection to the circuit board. Multiple vias to the grounding layer are recommended to connect the top layer ground area to the main ground layer.
3. Skyworks recommends including external bypass capacitors on the VDD voltage input (pin 37) of the device. These capacitors should be placed as close as possible to the VDD input pin.
4. A 50 Ω impedance trace is needed for the RF_OUT (pin 10) line.

Electrical and Mechanical Specifications

The absolute maximum ratings of the SKY73101 are provided in Table 3. The recommended operating conditions are specified in Table 4 and electrical specifications are provided in Table 5. Spur suppression measurements are provided in Table 6.

Measurement plots for single sideband phase noise and settling time are shown in Figures 5 and 6, respectively.

A typical application schematic for the SKY73101 is provided in Figure 7. Figure 8 shows the package dimensions for the 38-pin MCM and Figure 9 provides the tape and reel dimensions.

Electrostatic Discharge (ESD) Sensitivity

The SKY73101 ESD threshold level is 2500 VDC using Human Body Model (HBM) testing. This level applies to RF signal lines >100 MHz, analog and RF lines <100 MHz, digital lines, power supply lines, and ground pins.

To avoid latent or visible ESD damage, always follow proper ESD handling precautions.

Table 3. SKY73101 Absolute Maximum Ratings (Note 1)

Parameter	Symbol	Min	Typical	Max	Units
Supply voltage	VCC	0		5.5	V
Operating temperature, full performance	T _{OP}	-40		+85	°C
Storage temperature	T _{ST}	-40		+150	°C

Note 1: Exposure to maximum rating conditions for extended periods may reduce device reliability. There is no damage to device with only one parameter set at the limit and all other parameters set at or below their nominal values.

Table 4. SKY73101 Recommended Operating Conditions

Parameter	Symbol	Min	Typical	Max	Units
Supply voltage	VCC	4.75	5.00	5.25	V
Input voltage (CLK, DATA, LE): Low level High level		1.4		0.6	V V
Output voltage (LD) with 18 k Ω load from VCC PLL: Low level, unlocked High level, unlocked		2.4		0.4	V V
Reference frequency input voltage (FREF, pin 23)	FREF _{IN}	0.5	1.0	1.5	V _{p-p}
Load connected to RF output		50 Ω , maximum VSWR (load input) 2.0:1, all phases			
RF output switch enable: High Low	SWEN _H SWEN _L	4.75 0		5.25 0.8	V V

Table 5. SKY73101 Electrical Characteristics (Note 1)

(VCC = 5 V, Tc = 25 °C, Charge Pump Current = 1600 μA, FREF = 52 MHz, Reference Input Divider = 8, Prescale Divider = 8/9, Unless Otherwise Noted)

Parameter	Symbol	Test Conditions	Min	Typical	Max	Units
Oscillation frequency			1800		1990	MHz
Reference frequency				13	52	MHz
Phase detector frequency				6.5		MHz
PLL loop bandwidth				25		kHz
Output level				0		dBm
Output impedance				50		Ω
Output VSWR					*** TBD ***	–
Reference frequency input (FREF) impedance			470			Ω
Harmonic suppression					–20	dBc
Integrated phase noise		100 Hz to 100 kHz			1	degrees RMS
Single sideband phase noise offset:						
@ 1 kHz				–87		dBc/Hz
@ 5 kHz				–87		dBc/Hz
@ 10 kHz				–87		dBc/Hz
@ 200 kHz				–112		dBc/Hz
@ 400 kHz				–130		dBc/Hz
@ 600 kHz				–136		dBc/Hz
@ 800 kHz				–139		dBc/Hz
@ 1.8 MHz				–146		dBc/Hz
@6 MHz				–158		dBc/Hz
PLL-reference spurious suppression					–100	dBc
Frequency settling time		Within ±2 kHz		250		μs
Phase settling time		Within ±5 deg		300	530	μs
Peak phase error					5	degrees
Current consumption				120		mA

Note 1: Characterized performance may change if the SKY73101 is configured differently than the test conditions specified here. This characterization used a 6.5 MHz fixed comparison frequency for the PLL phase loop filter. The PLL synthesizer is programmable up to a maximum comparison frequency of 26 MHz but with degraded performance.

Table 6. SKY73101 Spur Suppression Measurements

(VCC = 5 V, Tc = 25 °C, Charge Pump Current = 1600 μA, FREF = 52 MHz, Reference Input Divider = 8, Prescale Divider = 8/9)

Spurious Power (kHz)	Frequency (MHz)					
	1800	1840	1880	1930	1960	1990
≥ 200	No spur	No spur	No spur	No spur	No spur	No spur
≥ 400	498.51 kHz –89 dBc	498.51 kHz –90 dBc	No spur	498.51 kHz, –92 dBc	No spur	No spur
≥ 600	No spur	No spur	No spur	No spur	No spur	No spur
≥ 800	No spur	No spur	No spur	No spur	No spur	No spur
≥ 1000	No spur	No spur	No spur	2575.45 kHz, –95 dBc	No spur	1000.00 kHz, –91 dBc
≥ 3000	5259.33 kHz, –99 dBc 9310.91 kHz, –106 dBc	3488.48 kHz, –101 dBc 6515.59 kHz, –99 dBc	No spur	No spur	6515.59 kHz, –100 dBc	No spur

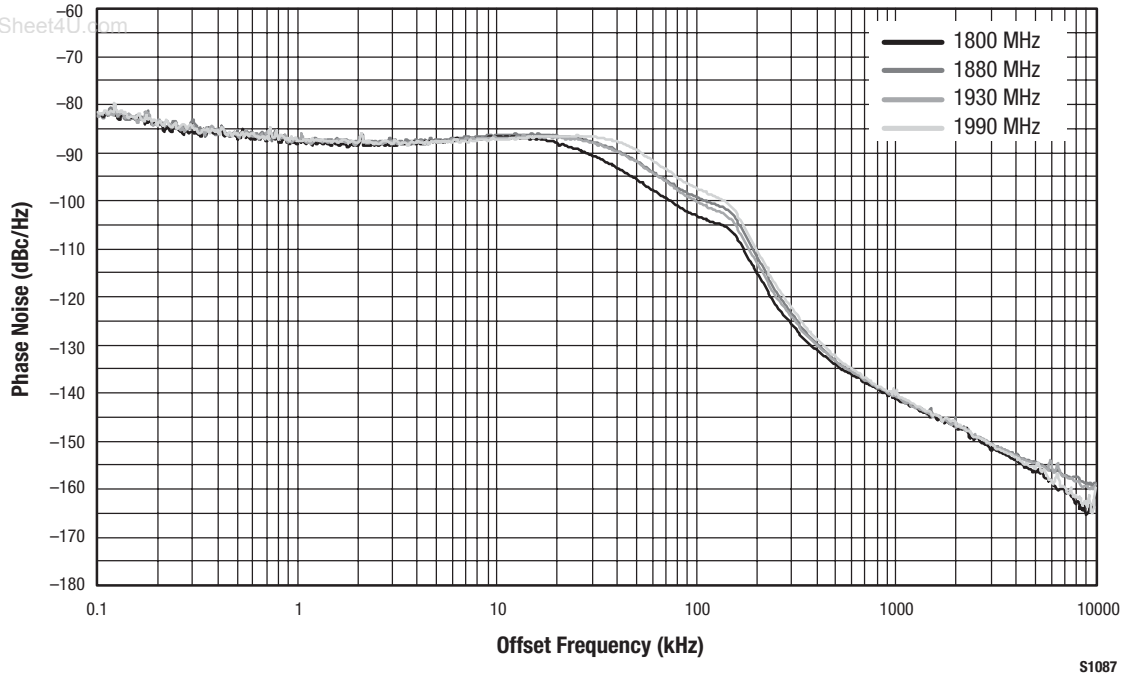

Figure 5. Single Sideband Phase Noise Measurements

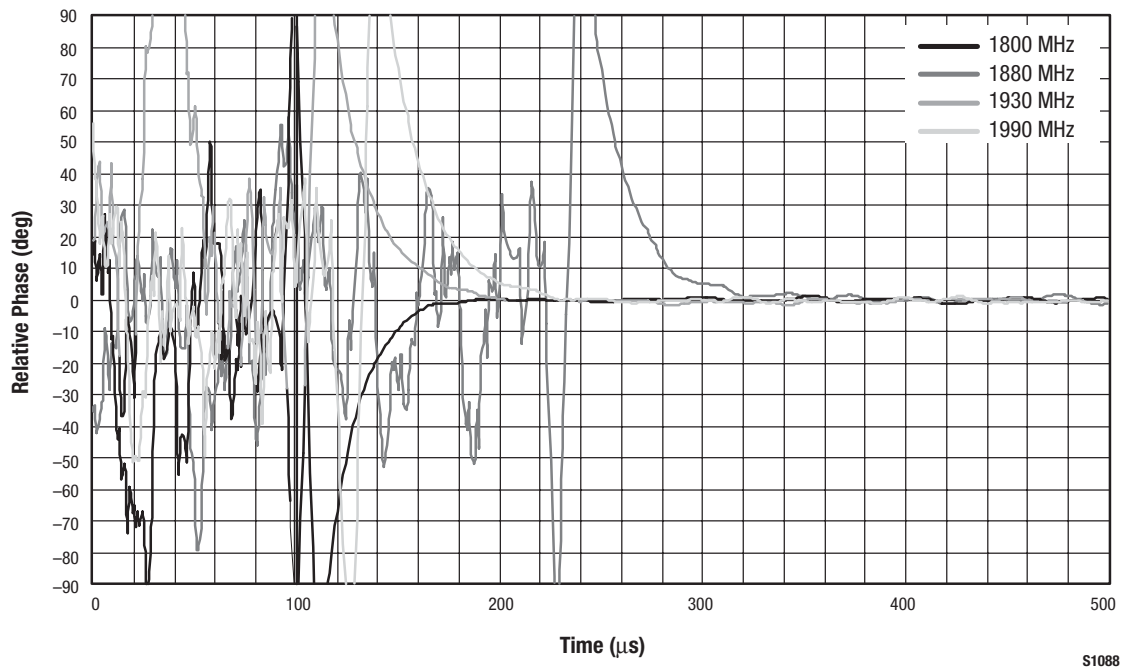
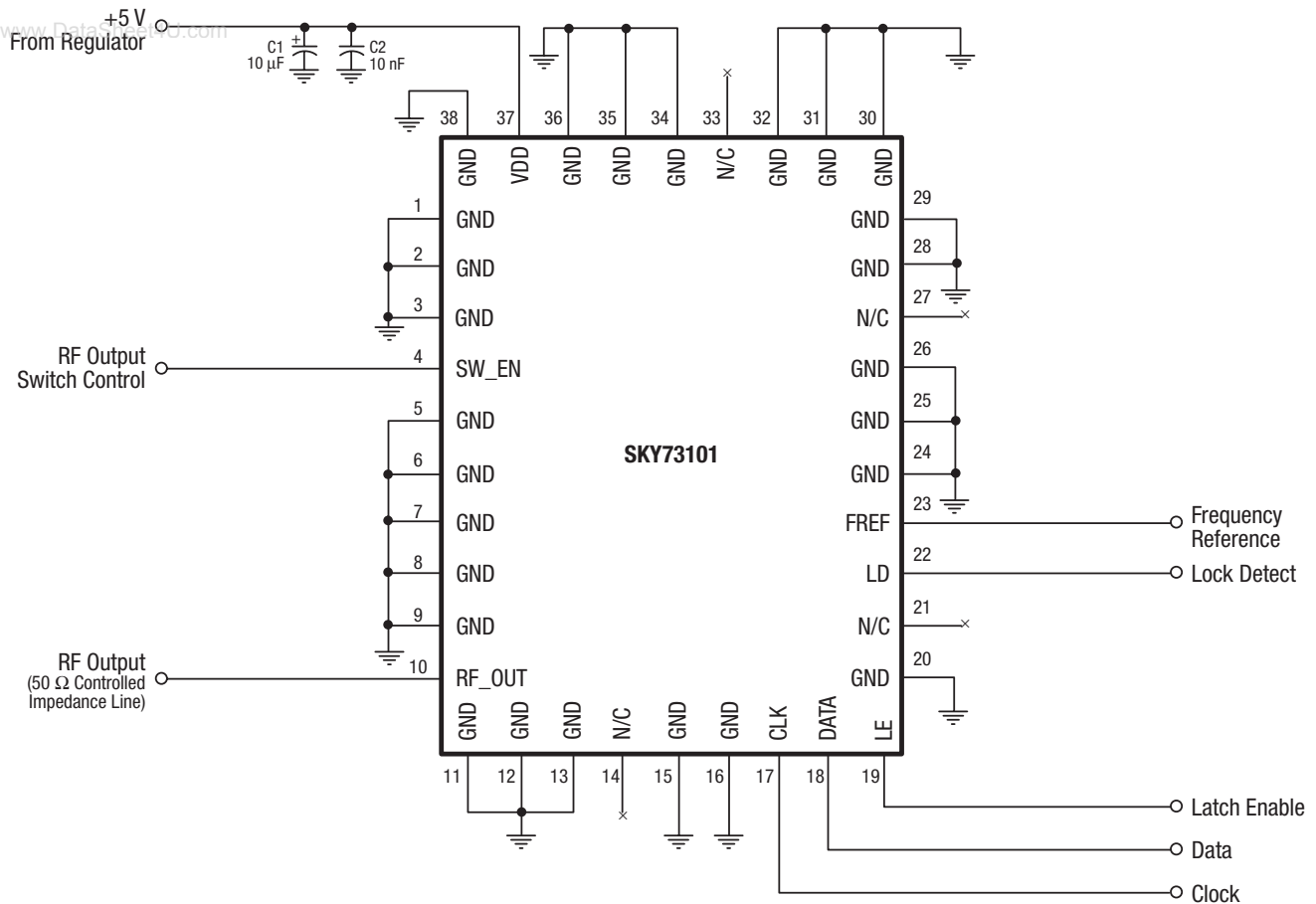

Figure 6. Settling Time Measurements



S1086

Figure 7. SKY73101 Typical Application Schematic

www.DataSheet4U.com

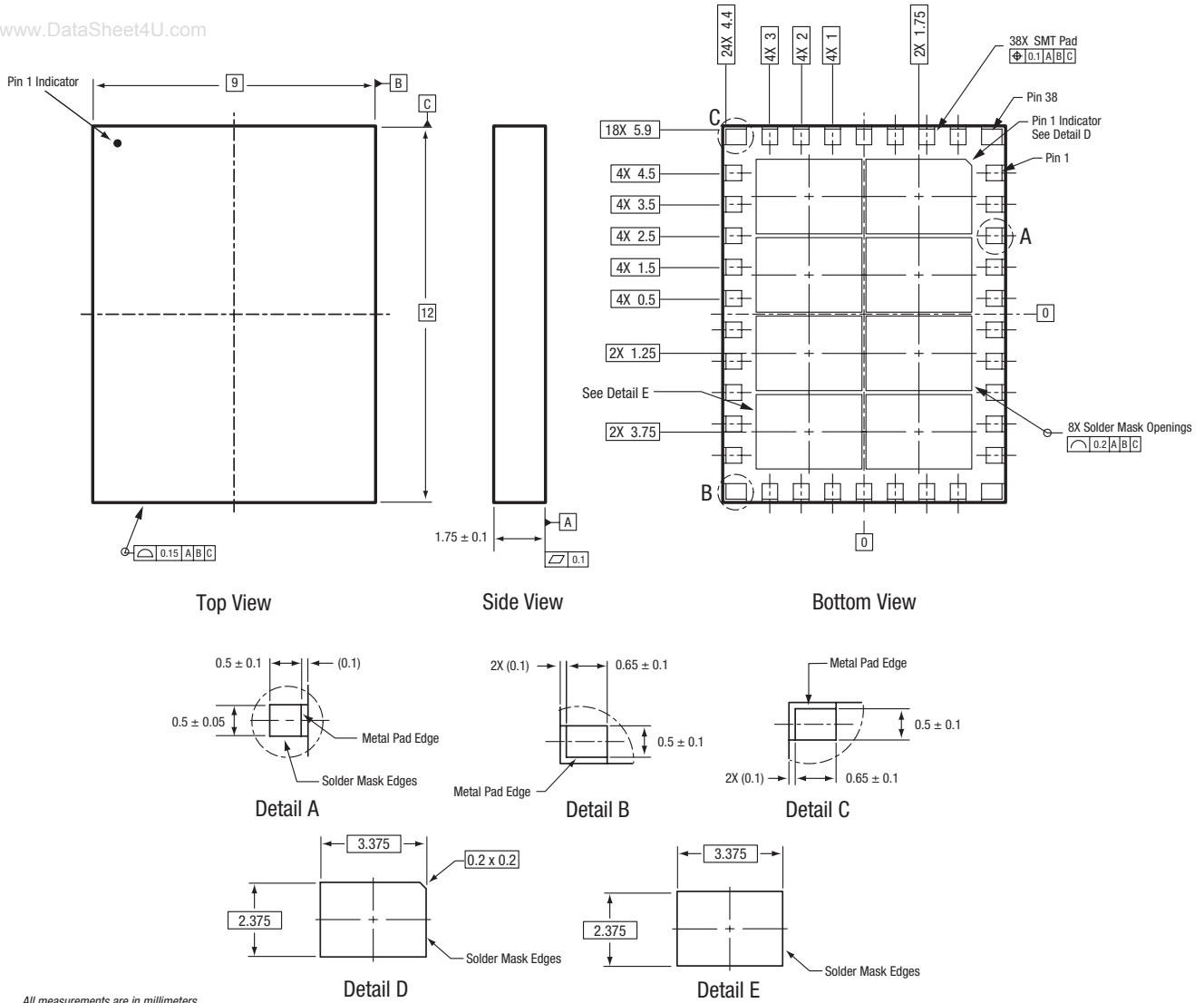

All measurements are in millimeters.

Dimensioning and tolerancing according to ASME Y14.5M-1994.

S960

Figure 8. SKY73101 38-Pin MCM Package Dimensions

www.DataSheet4U.com

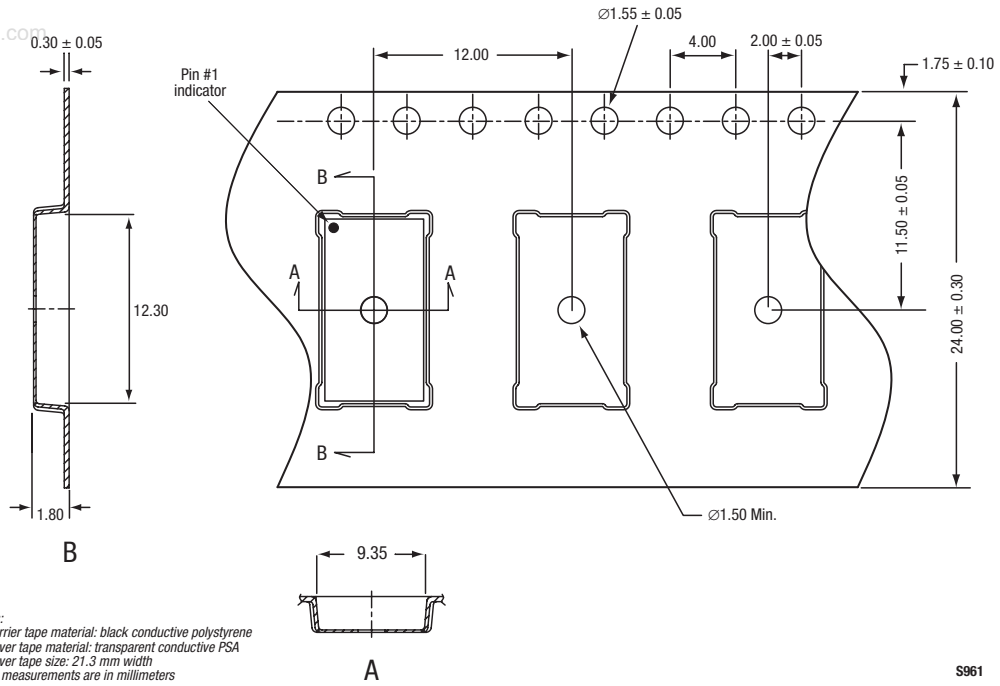

S961

Figure 9. SKY73101 Tape and Reel Dimensions

Ordering Information

Model Name	Manufacturing Part Number	Evaluation Kit Part Number
SKY73101 1805-1990 MHz VCO/Synthesizer	SKY73101-11 (Pb-free package)	

Copyright © 2007, Skyworks Solutions, Inc. All Rights Reserved.

Information in this document is provided in connection with Skyworks Solutions, Inc. ("Skyworks") products or services. These materials, including the information contained herein, are provided by Skyworks as a service to its customers and may be used for informational purposes only by the customer. Skyworks assumes no responsibility for errors or omissions in these materials or the information contained herein. Skyworks may change its documentation, products, services, specifications or product descriptions at any time, without notice. Skyworks makes no commitment to update the materials or information and shall have no responsibility whatsoever for conflicts, incompatibilities, or other difficulties arising from any future changes.

No license, whether express, implied, by estoppel or otherwise, is granted to any intellectual property rights by this document. Skyworks assumes no liability for any materials, products or information provided hereunder, including the sale, distribution, reproduction or use of Skyworks products, information or materials, except as may be provided in Skyworks Terms and Conditions of Sale.

THE MATERIALS, PRODUCTS AND INFORMATION ARE PROVIDED "AS IS" WITHOUT WARRANTY OF ANY KIND, WHETHER EXPRESS, IMPLIED, STATUTORY, OR OTHERWISE, INCLUDING FITNESS FOR A PARTICULAR PURPOSE OR USE, MERCHANTABILITY, PERFORMANCE, QUALITY OR NON-INFRINGEMENT OF ANY INTELLECTUAL PROPERTY RIGHT; ALL SUCH WARRANTIES ARE HEREBY EXPRESSLY DISCLAIMED. SKYWORKS DOES NOT WARRANT THE ACCURACY OR COMPLETENESS OF THE INFORMATION, TEXT, GRAPHICS OR OTHER ITEMS CONTAINED WITHIN THESE MATERIALS. SKYWORKS SHALL NOT BE LIABLE FOR ANY DAMAGES, INCLUDING BUT NOT LIMITED TO ANY SPECIAL, INDIRECT, INCIDENTAL, STATUTORY, OR CONSEQUENTIAL DAMAGES, INCLUDING WITHOUT LIMITATION, LOST REVENUES OR LOST PROFITS THAT MAY RESULT FROM THE USE OF THE MATERIALS OR INFORMATION, WHETHER OR NOT THE RECIPIENT OF MATERIALS HAS BEEN ADVISED OF THE POSSIBILITY OF SUCH DAMAGE.

Skyworks products are not intended for use in medical, lifesaving or life-sustaining applications, or other equipment in which the failure of the Skyworks products could lead to personal injury, death, physical or environmental damage. Skyworks customers using or selling Skyworks products for use in such applications do so at their own risk and agree to fully indemnify Skyworks for any damages resulting from such improper use or sale.

Customers are responsible for their products and applications using Skyworks products, which may deviate from published specifications as a result of design defects, errors, or operation of products outside of published parameters or design specifications. Customers should include design and operating safeguards to minimize these and other risks. Skyworks assumes no liability for applications assistance, customer product design, or damage to any equipment resulting from the use of Skyworks products outside of stated published specifications or parameters.

Skyworks, the Skyworks symbol, and "Breakthrough Simplicity" are trademarks or registered trademarks of Skyworks Solutions, Inc., in the United States and other countries. Third-party brands and names are for identification purposes only, and are the property of their respective owners. Additional information, including relevant terms and conditions, posted at www.skyworksinc.com, are incorporated by reference.