

DATA SHEET

BF547 NPN 1 GHz wideband transistor

Product specification
File under Discrete Semiconductors, SC14

September 1995

NPN 1 GHz wideband transistor

BF547

FEATURES

- Feedback capacitance typ. 1 pF
- Stable oscillator operation
- High current gain
- Good thermal stability.

APPLICATIONS

- It is intended for VHF and UHF TV-tuner applications and can be used as a mixer and/or oscillator.

PINNING

PIN	DESCRIPTION
1	base
2	emitter
3	collector

DESCRIPTION

Low cost NPN transistor in a plastic SOT23 package.

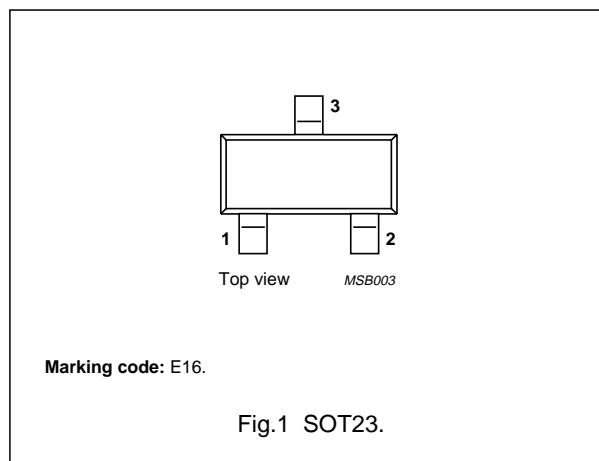

QUICK REFERENCE DATA

SYMBOL	PARAMETER	CONDITIONS	MIN.	MAX.	UNIT
V_{CEO}	collector-emitter voltage	open base	–	20	V
V_{CBO}	collector-base voltage	open emitter	–	30	V
V_{EBO}	emitter-base voltage	open collector	–	3	V
I_{CM}	peak collector current		–	50	mA
P_{tot}	total power dissipation	up to $T_s = 70\text{ °C}$; note 1	–	300	mW
f_T	transition frequency	$I_C = 15\text{ mA}$; $V_{CE} = 10\text{ V}$; $f = 500\text{ MHz}$	1.2	1.6	GHz
C_{re}	feedback capacitance	$I_E = I_e = 0$; $V_{CB} = 10\text{ V}$; $f = 1\text{ MHz}$	1	–	pF

Note

1. T_s is the temperature at the soldering point of the collector pin.

LIMITING VALUES

In accordance with the Absolute Maximum Rating System (IEC 134).

SYMBOL	PARAMETER	CONDITIONS	MIN.	MAX.	UNIT
V_{CEO}	collector-emitter voltage	open base	–	20	V
V_{CBO}	collector-base voltage	open emitter	–	30	V
V_{EBO}	emitter-base voltage	open collector	–	3	V
I_{CM}	peak collector current		–	50	mA
P_{tot}	total power dissipation	up to $T_s = 70\text{ °C}$; note 1	–	300	mW
T_{stg}	storage temperature range		–65	+150	°C
T_j	junction temperature		–	150	°C

Note

1. T_s is the temperature at the soldering point of the collector pin.

NPN 1 GHz wideband transistor

BF547

THERMAL CHARACTERISTICS

SYMBOL	PARAMETER	CONDITIONS	VALUE	UNIT
$R_{th\ j-s}$	from junction to soldering point	note 1	260	K/W

Note

- T_s is the temperature at the soldering point of the collector pin.

CHARACTERISTICS

$T_j = 25\text{ }^\circ\text{C}$ unless otherwise specified.

SYMBOL	PARAMETER	CONDITIONS	MIN.	TYP.	MAX.	UNIT
I_{CBO}	collector cut-off current	$I_E = 0; V_{CB} = 10\text{ V}$	–	–	100	nA
h_{FE}	DC current gain	$I_C = 2\text{ mA}; V_{CE} = 10\text{ V}$	40	95	250	
f_T	transition frequency	$I_C = 15\text{ mA}; V_{CE} = 10\text{ V}; f = 500\text{ MHz}$	0.8	1.2	1.6	GHz
C_{re}	feedback capacitance	$I_E = i_e = 0; V_{CB} = 10\text{ V}; f = 1\text{ MHz}$	–	1	–	pF
G_{UM}	maximum unilateral power gain; note 1	$I_C = 1\text{ mA}; V_{CE} = 10\text{ V}; f = 100\text{ MHz}$	–	20	–	dB

Note

- G_{UM} is the maximum unilateral power gain, assuming S_{12} is zero and $G_{UM} = 10 \log \frac{|S_{21}|^2}{(1 - |S_{11}|^2)(1 - |S_{22}|^2)}$ dB.

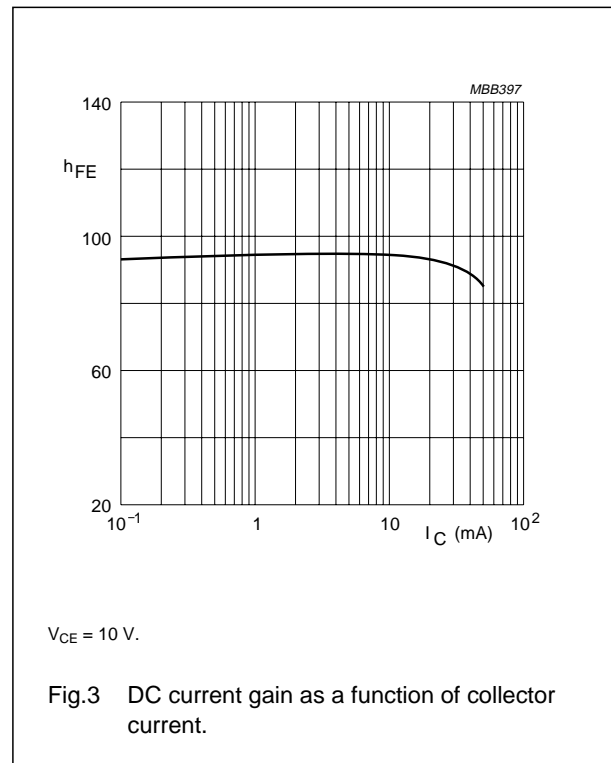
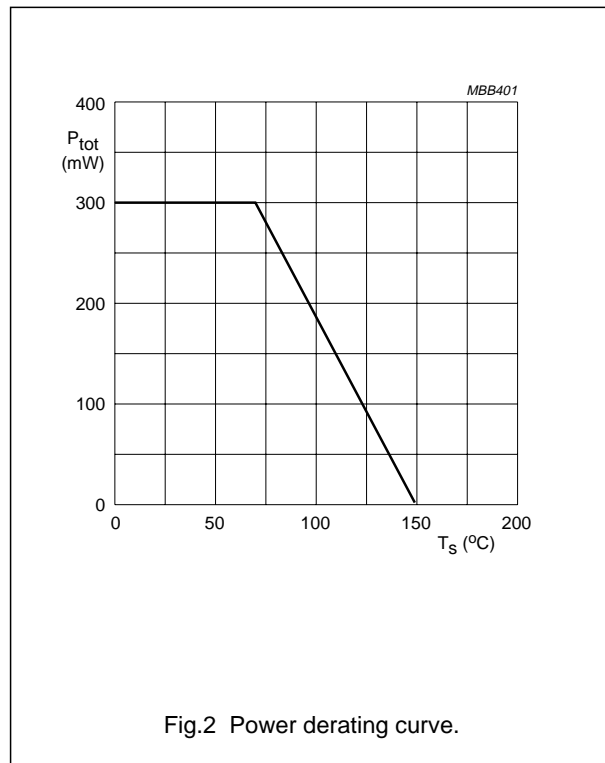

NPN 1 GHz wideband transistor

BF547

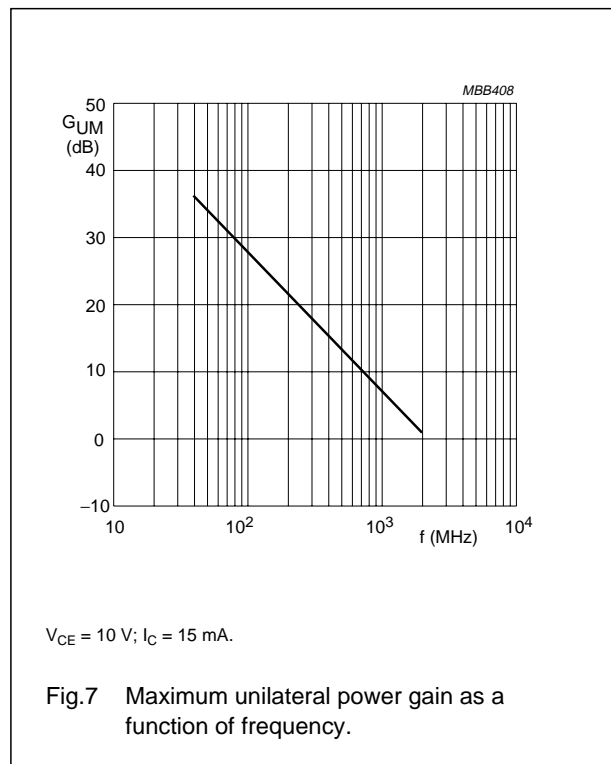
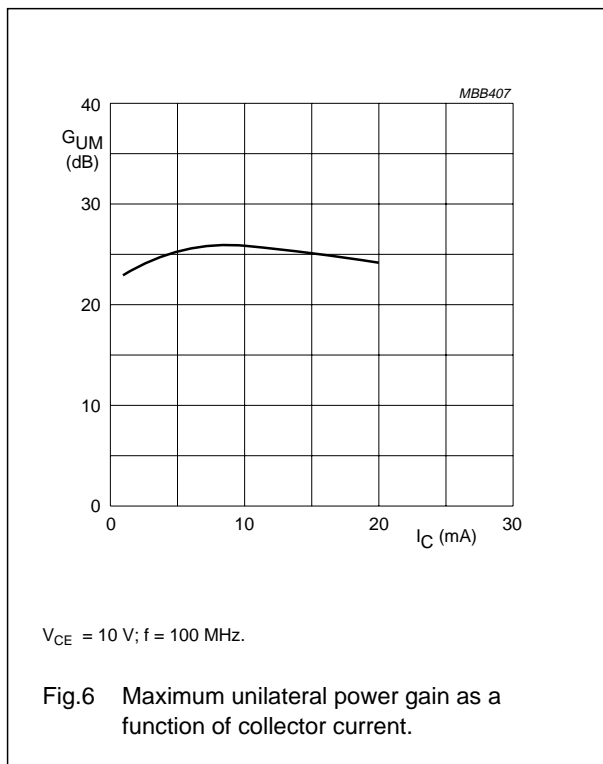
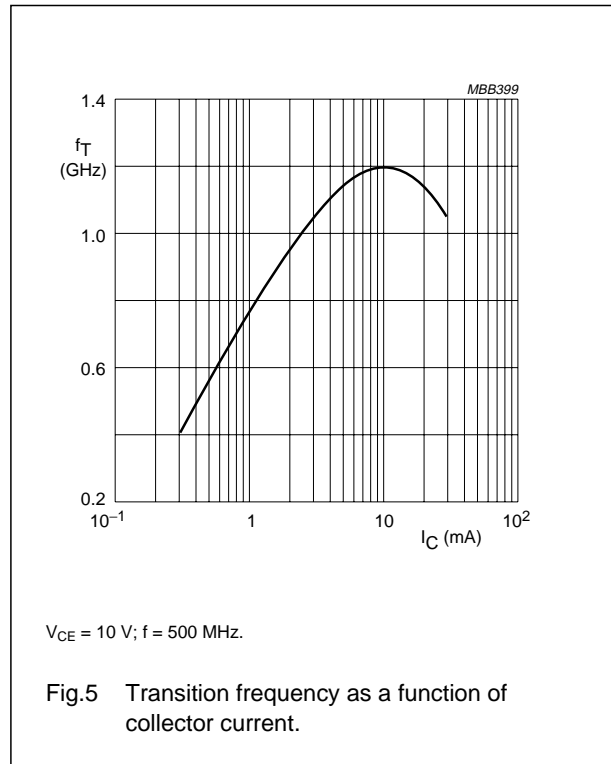
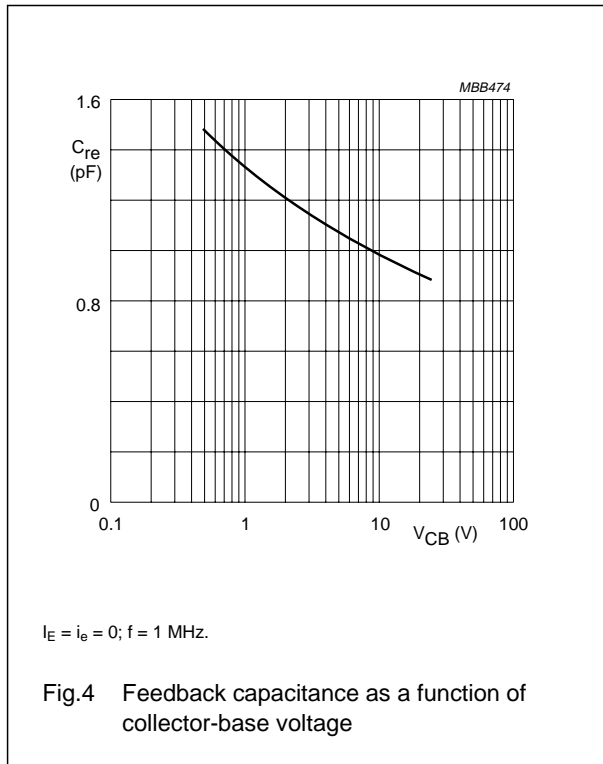

NPN 1 GHz wideband transistor

BF547

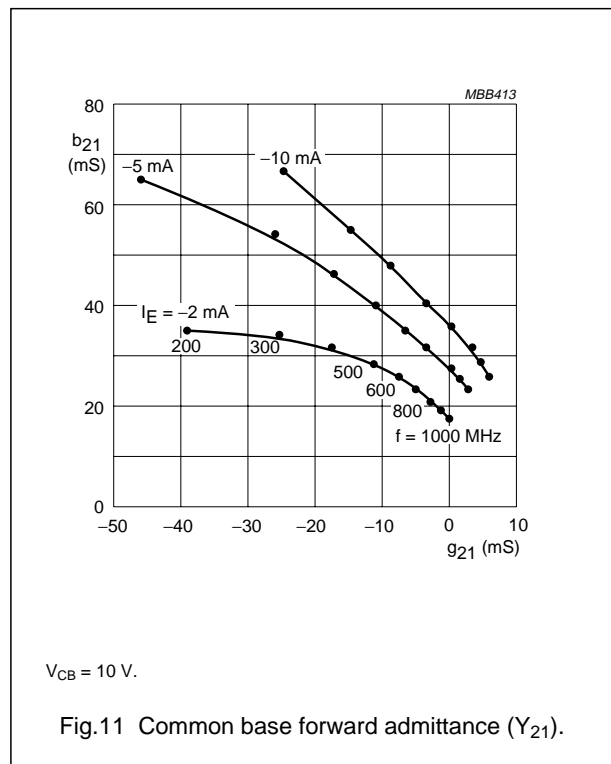
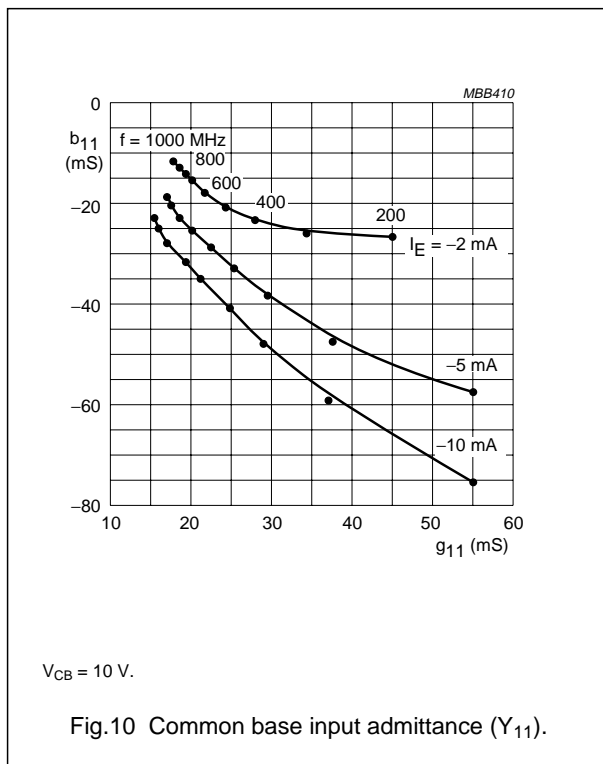
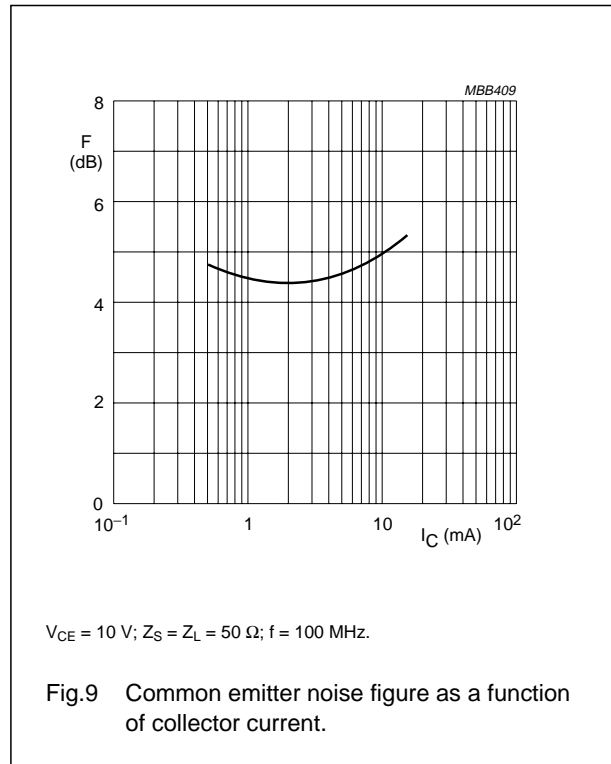
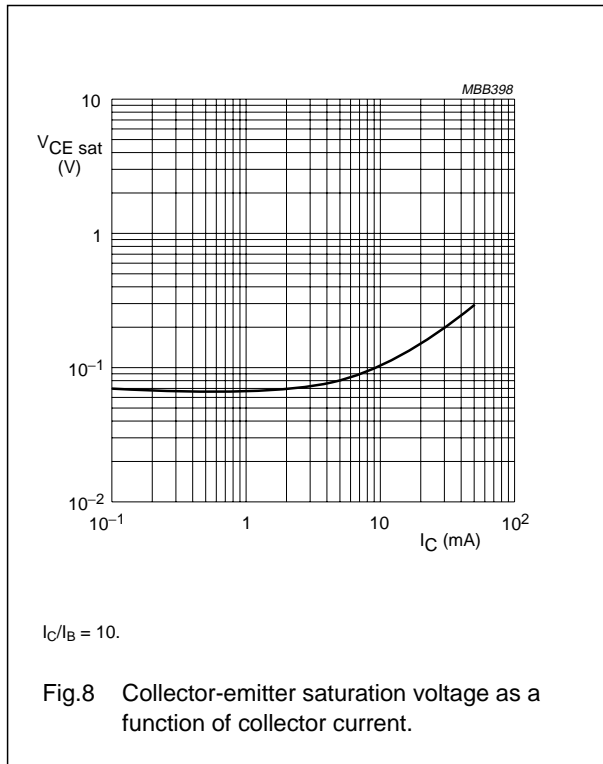

NPN 1 GHz wideband transistor

BF547

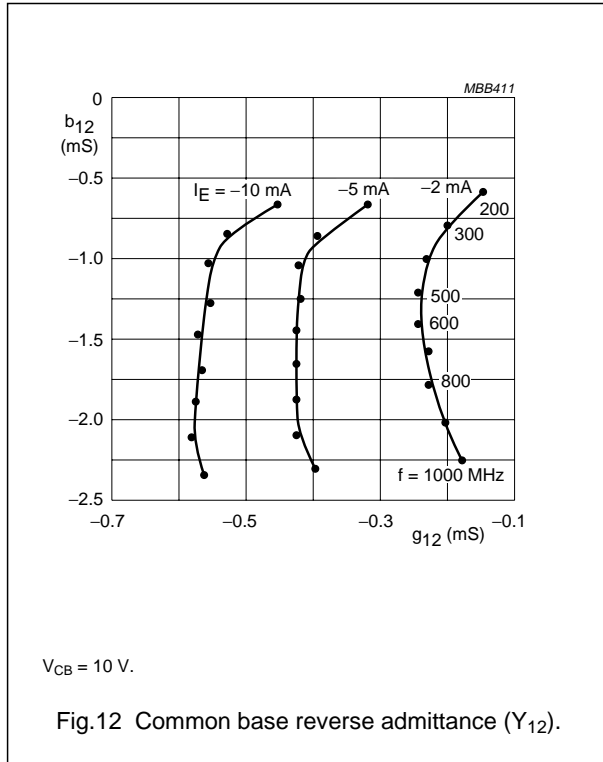

Fig.12 Common base reverse admittance (Y_{12}).

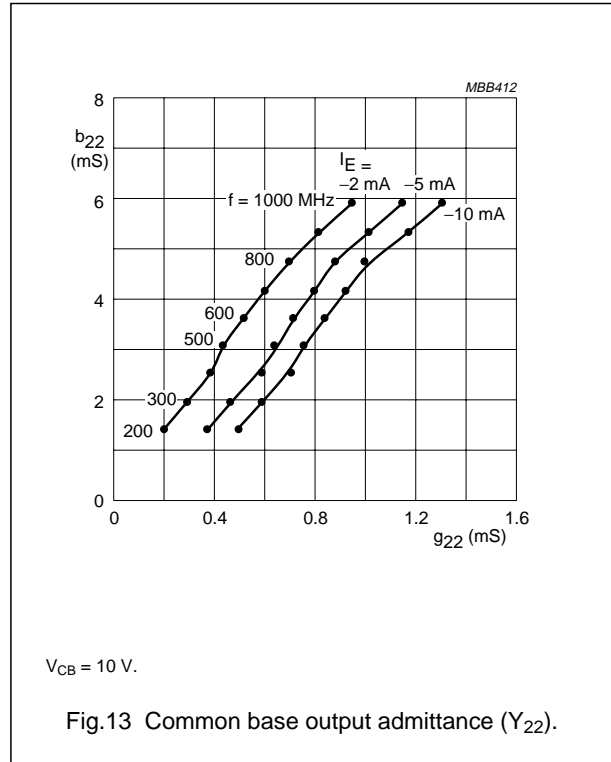
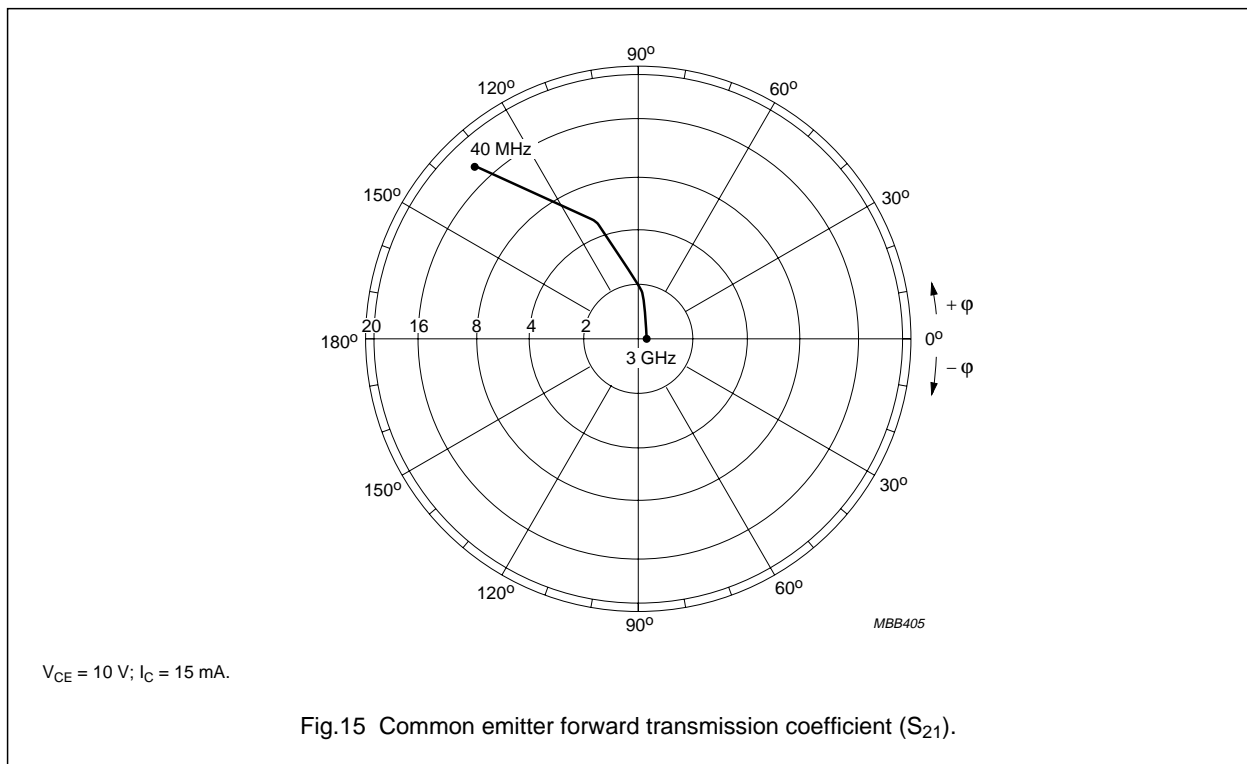
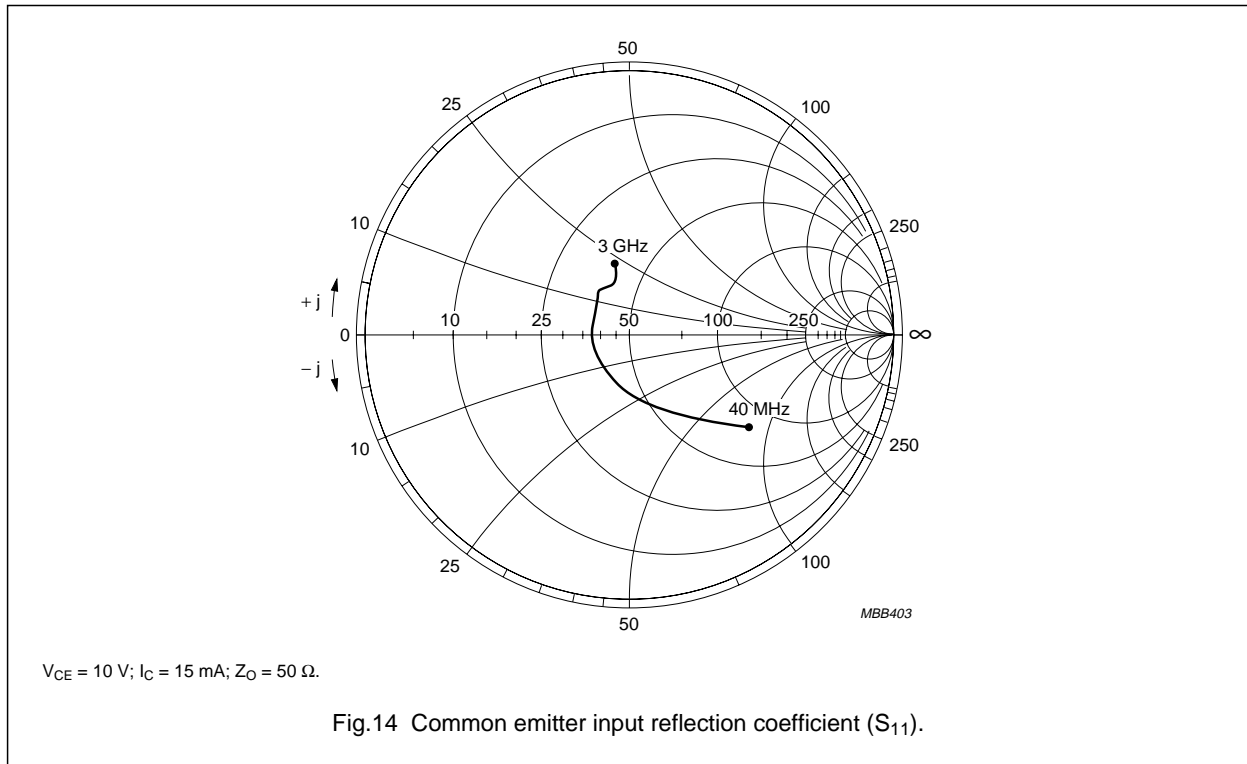

Fig.13 Common base output admittance (Y_{22}).

NPN 1 GHz wideband transistor

BF547



NPN 1 GHz wideband transistor

BF547

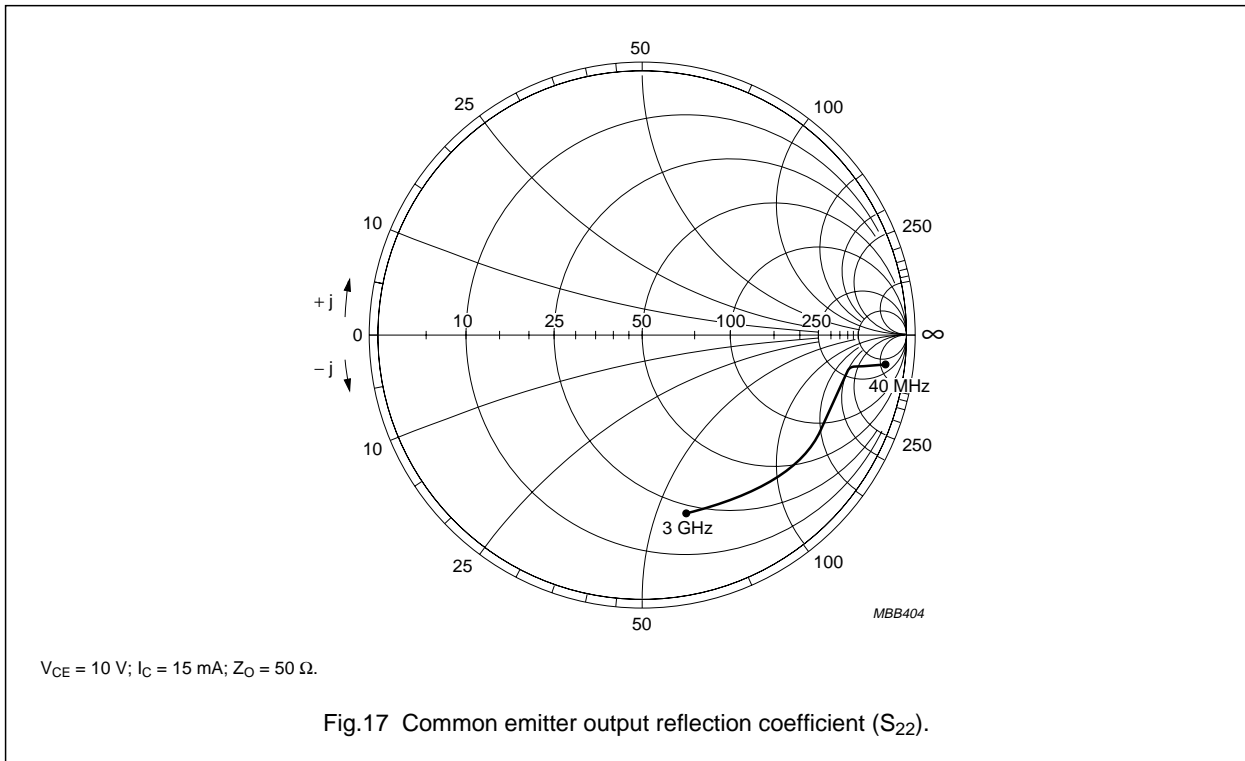
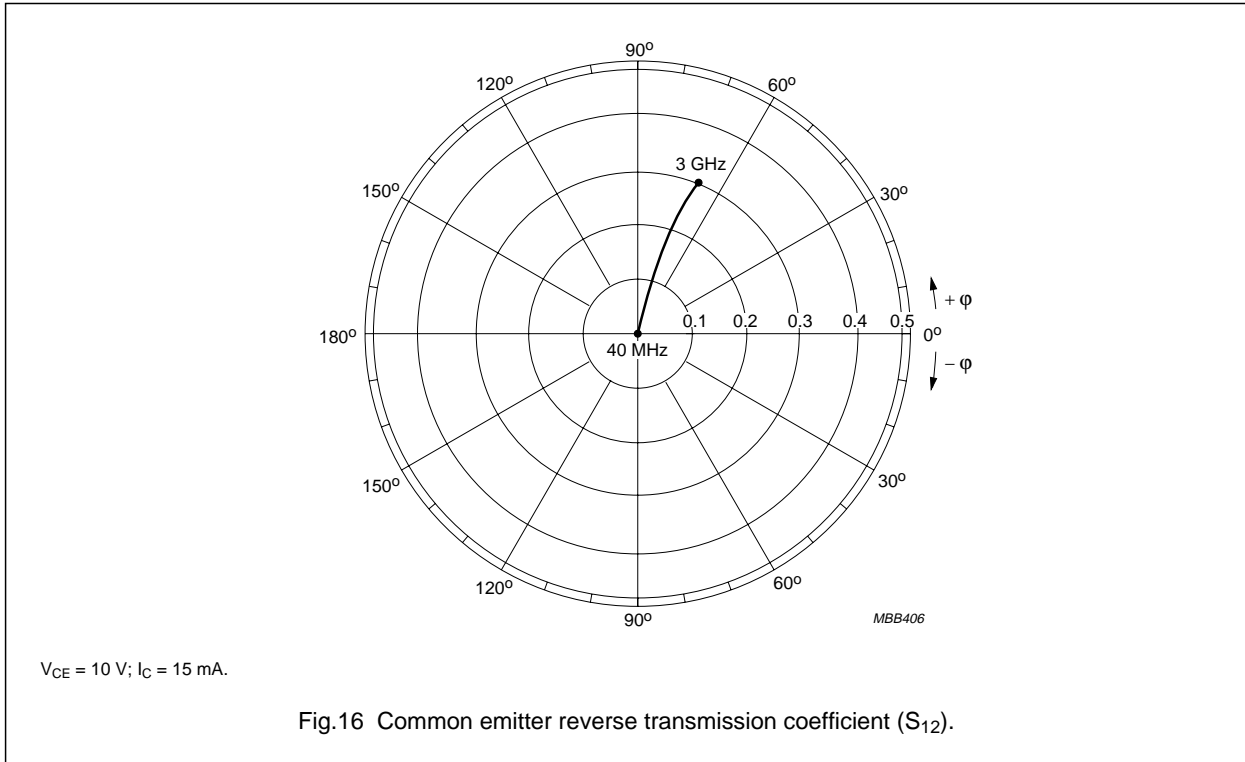

NPN 1 GHz wideband transistor

BF547

Table 1 Common base Y-parameters; $V_{CB} = 10\text{ V}$; $I_E = -2\text{ mA}$

f (MHz)	Y ₁₁		Y ₂₁		Y ₁₂		Y ₂₂	
	REAL (mS)	IMAG. (mS)	REAL (mS)	IMAG. (mS)	REAL (mS)	IMAG. (mS)	REAL (mS)	IMAG. (mS)
40	69.0	-10.2	-68.0	12.3	-0.02	-0.1	-0.01	0.3
100	60.4	-20.6	-58.0	25.6	-0.06	-0.3	-0.08	0.7
200	45.0	-27.4	-39.1	34.5	-0.10	-0.6	0.19	1.4
300	34.3	-26.4	-25.4	34.0	-0.20	-0.8	0.29	1.9
400	27.7	-23.3	-17.2	31.1	-0.20	-1.0	0.37	2.5
500	24.0	-20.4	-11.7	27.6	-0.20	-1.2	0.45	3.0
600	21.5	-18.0	-7.8	25.0	-0.20	-1.4	0.53	3.6
700	20.0	-15.6	-5.3	22.6	-0.20	-1.6	0.60	4.2
800	18.6	-14.0	-3.0	20.2	-0.20	-1.8	0.69	4.7
900	18.3	-12.8	-1.3	18.7	-0.20	-2.0	0.82	5.3
1000	17.8	-11.7	-0.1	17.1	-0.20	-2.2	0.95	5.9

Table 2 Common base Y-parameters; $V_{CB} = 10\text{ V}$; $I_E = -5\text{ mA}$

f (MHz)	Y ₁₁		Y ₂₁		Y ₁₂		Y ₂₂	
	REAL (mS)	IMAG. (mS)	REAL (mS)	IMAG. (mS)	REAL (mS)	IMAG. (mS)	REAL (mS)	IMAG. (mS)
40	132.6	-35.7	-130.5	38.8	-0.06	-0.2	-0.06	0.4
100	96.3	-62.0	-91.1	67.9	-0.20	-0.5	0.21	0.8
200	54.7	-57.8	-46.0	64.7	-0.30	-0.7	0.38	1.4
300	37.5	-46.9	-26.4	53.8	-0.40	-0.8	0.47	2.0
400	29.2	-38.6	-16.6	45.8	-0.40	-1.0	0.58	2.5
500	25.3	-32.8	-11.0	39.8	-0.40	-1.3	0.63	3.1
600	22.0	-28.4	-6.3	35.0	-0.40	-1.4	0.71	3.6
700	20.3	-25.2	-3.3	31.4	-0.40	-1.6	0.80	4.2
800	18.7	-22.6	-0.6	27.6	-0.40	-1.9	0.88	4.7
900	17.8	-20.7	1.4	25.2	-0.40	-2.1	1.01	5.3
1000	17.3	-19.1	3.0	23.0	-0.40	-2.3	1.15	6.0

NPN 1 GHz wideband transistor

BF547

Table 3 Common base Y-parameters; $V_{CB} = 10\text{ V}$; $I_E = -10\text{ mA}$

f (MHz)	Y ₁₁		Y ₂₁		Y ₁₂		Y ₂₂	
	REAL (mS)	IMAG. (mS)	REAL (mS)	IMAG. (mS)	REAL (mS)	IMAG. (mS)	REAL (mS)	IMAG. (mS)
40	189.0	-79.6	-185.5	83.0	-0.10	-0.3	-0.09	0.4
100	108.5	-99.0	-101.4	105.4	-0.30	-0.5	0.30	0.9
200	55.2	-76.2	-44.6	82.8	-0.50	-0.7	0.44	1.4
300	37.1	-59.0	-24.3	65.7	-0.50	-0.9	0.60	2.0
400	28.8	-47.6	-14.6	54.4	-0.60	-1.0	0.69	2.5
500	24.7	-40.2	-8.6	46.7	-0.60	-1.3	0.75	3.1
600	21.2	-35.0	-3.4	40.8	-0.60	-1.5	0.84	3.6
700	19.3	-31.0	-0.2	36.2	-0.60	-1.7	0.93	4.2
800	17.2	-27.5	2.6	31.1	-0.60	-1.9	1.00	4.7
900	16.4	-25.2	4.6	28.3	-0.60	-2.1	1.15	5.3
1000	15.8	-23.0	6.0	25.5	-0.60	-2.3	1.31	6.0

Table 4 Common base Y-parameters; $V_{CB} = 10\text{ V}$; $I_E = -15\text{ mA}$

f (MHz)	Y ₁₁		Y ₂₁		Y ₁₂		Y ₂₂	
	REAL (mS)	IMAG. (mS)	REAL (mS)	IMAG. (mS)	REAL (mS)	IMAG. (mS)	REAL (mS)	IMAG. (mS)
40	206.5	-113.8	-202.6	118.1	-0.20	-0.3	0.2	0.5
100	104.3	-114.0	-96.4	120.1	-0.40	-0.5	0.4	0.9
200	53.1	-81.1	-41.7	87.7	-0.50	-0.7	0.6	1.4
300	35.9	-62.1	-22.0	68.6	-0.60	-0.8	0.7	2.0
400	28.1	-50.0	-12.5	56.9	-0.60	-1.1	0.8	2.5
500	23.4	-42.3	-6.1	48.2	-0.60	-1.3	0.8	3.1
600	20.1	-36.4	-1.2	41.6	-0.60	-1.5	0.9	3.6
700	18.2	-32.0	2.0	36.7	-0.60	-1.7	1.0	4.2
800	16.2	-28.2	4.5	31.3	-0.60	-1.9	1.1	4.7
900	15.5	-25.7	6.5	28.1	-0.60	-2.1	1.3	5.3
1000	14.7	-23.5	7.9	24.9	-0.60	-2.3	1.4	5.9

NPN 1 GHz wideband transistor

BF547

PACKAGE OUTLINE

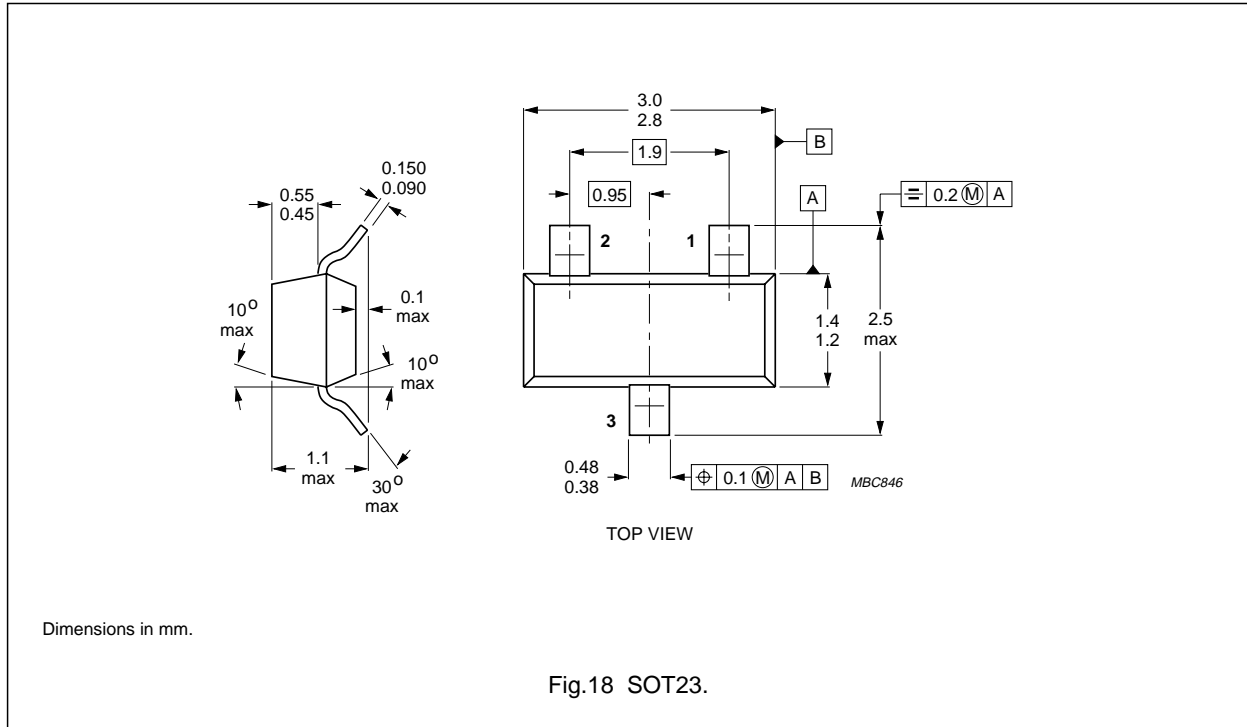

DEFINITIONS

Data sheet status	
Objective specification	This data sheet contains target or goal specifications for product development.
Preliminary specification	This data sheet contains preliminary data; supplementary data may be published later.
Product specification	This data sheet contains final product specifications.
Limiting values	
Limiting values given are in accordance with the Absolute Maximum Rating System (IEC 134). Stress above one or more of the limiting values may cause permanent damage to the device. These are stress ratings only and operation of the device at these or at any other conditions above those given in the Characteristics sections of the specification is not implied. Exposure to limiting values for extended periods may affect device reliability.	
Application information	
Where application information is given, it is advisory and does not form part of the specification.	

LIFE SUPPORT APPLICATIONS

These products are not designed for use in life support appliances, devices, or systems where malfunction of these products can reasonably be expected to result in personal injury. Philips customers using or selling these products for use in such applications do so at their own risk and agree to fully indemnify Philips for any damages resulting from such improper use or sale.