

N-Channel Dual Gate MOS-Fieldeffect Tetrode, Depletion Mode

Electrostatic sensitive device.
Observe precautions for handling.



Applications

Input- and mixer stages especially for FM- and VHF TV-tuners up to 300 MHz.

Features

- Integrated gate protection diodes
- High cross modulation performance
- Low noise figure
- High AGC-range
- Low feedback capacitance

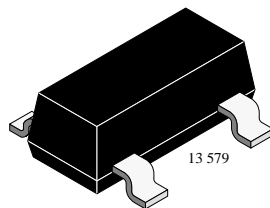
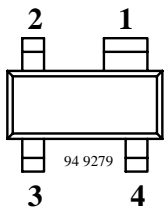

BF995 Marking: MB
Plastic case (SOT 143)
1=Source, 2=Drain, 3=Gate 2, 4=Gate 1

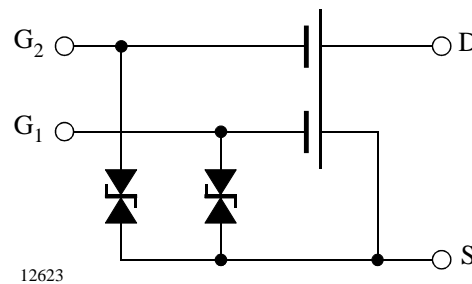

Absolute Maximum Ratings

$T_{amb} = 25^{\circ}\text{C}$, unless otherwise specified

Parameter	Test Conditions	Type	Symbol	Value	Unit
Drain - source voltage			V_{DS}	20	V
Drain current			I_D	30	mA
Gate 1/Gate 2 - source peak current			$\pm I_{G1/G2SM}$	10	mA
Total power dissipation	$T_{amb} \leq 60^{\circ}\text{C}$		P_{tot}	200	mW
Channel temperature			T_{Ch}	150	$^{\circ}\text{C}$
Storage temperature range			T_{stg}	-55 to +150	$^{\circ}\text{C}$

Maximum Thermal Resistance

$T_{amb} = 25^{\circ}\text{C}$, unless otherwise specified

Parameter	Test Conditions	Symbol	Value	Unit
Channel ambient	on glass fibre printed board (25 x 20 x 1.5) mm ³ plated with 35 μm Cu	R_{thChA}	450	K/W

Electrical DC Characteristics

$T_{amb} = 25^{\circ}\text{C}$, unless otherwise specified

Parameter	Test Conditions	Type	Symbol	Min	Typ	Max	Unit
Drain - source breakdown voltage	$I_D = 10 \mu\text{A}$, $-V_{G1S} = -V_{G2S} = 4 \text{ V}$		$V_{(BR)DS}$	20			V
Gate 1 - source breakdown voltage	$\pm I_{G1S} = 10 \text{ mA}$, $V_{G2S} = V_{DS} = 0$		$\pm V_{(BR)G1SS}$	8		14	V
Gate 2 - source breakdown voltage	$\pm I_{G2S} = 10 \text{ mA}$, $V_{G1S} = V_{DS} = 0$		$\pm V_{(BR)G2SS}$	8		14	V
Gate 1 - source leakage current	$\pm V_{G1S} = 5 \text{ V}$, $V_{G2S} = V_{DS} = 0$		$\pm I_{G1SS}$			100	nA
Gate 2 - source leakage current	$\pm V_{G2S} = 5 \text{ V}$, $V_{G1S} = V_{DS} = 0$		$\pm I_{G2SS}$			100	nA
Drain current	$V_{DS} = 15 \text{ V}$, $V_{G1S} = 0$, $V_{G2S} = 4 \text{ V}$	BF995	I_{DSS}	4		18	mA
		BF995A	I_{DSS}	4		10.5	mA
		BF995B	I_{DSS}	9.5		18	mA
Gate 1 - source cut-off voltage	$V_{DS} = 15 \text{ V}$, $V_{G2S} = 4 \text{ V}$, $I_D = 20 \mu\text{A}$		$-V_{G1S(OFF)}$			3.5	V
Gate 2 - source cut-off voltage	$V_{DS} = 15 \text{ V}$, $V_{G1S} = 0$, $I_D = 20 \mu\text{A}$		$-V_{G2S(OFF)}$			3.5	V

Electrical AC Characteristics

$V_{DS} = 15 \text{ V}$, $I_D = 10 \text{ mA}$, $V_{G2S} = 4 \text{ V}$, $f = 1 \text{ MHz}$, $T_{amb} = 25^{\circ}\text{C}$, unless otherwise specified

Parameter	Test Conditions	Symbol	Min	Typ	Max	Unit
Forward transadmittance		$ y_{21s} $	12	15		mS
Gate 1 input capacitance		C_{issg1}		3.7		pF
Gate 2 input capacitance	$V_{G1S} = 0$, $V_{G2S} = 4 \text{ V}$	C_{issg2}		1.6		pF
Feedback capacitance		C_{rss}		25		fF
Output capacitance		C_{oss}		1.6		pF
Power gain	$G_S = 2 \text{ mS}$, $G_L = 0.5 \text{ mS}$, $f = 200 \text{ MHz}$	G_{ps}		20		dB
AGC range	$V_{G2S} = 4 \text{ to } -2 \text{ V}$, $f = 200 \text{ MHz}$	ΔG_{ps}		50		dB
Noise figure	$G_S = 2 \text{ mS}$, $G_L = 0.5 \text{ mS}$, $f = 200 \text{ MHz}$	F		1.8	2.5	dB

Typical Characteristics ($T_{amb} = 25^{\circ}\text{C}$ unless otherwise specified)

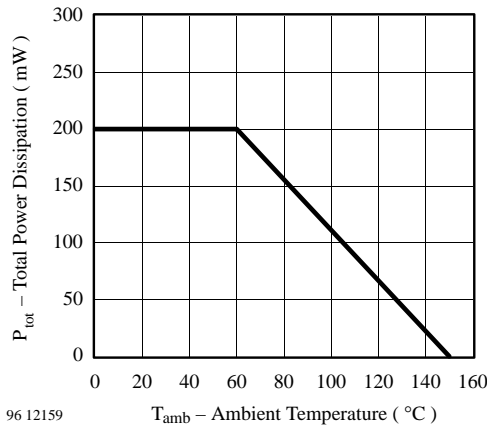

96 12159

Figure 1. Total Power Dissipation vs. Ambient Temperature

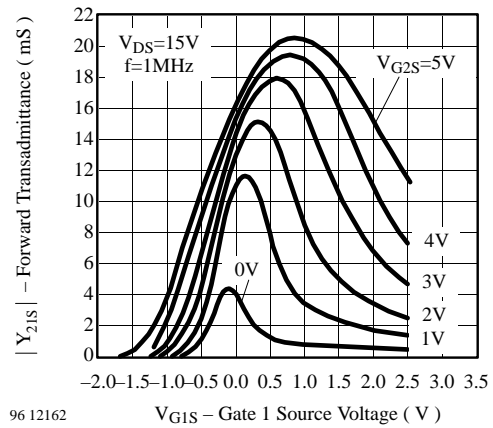

96 12162

Figure 4. Forward Transadmittance vs. Gate 1 Source Voltage

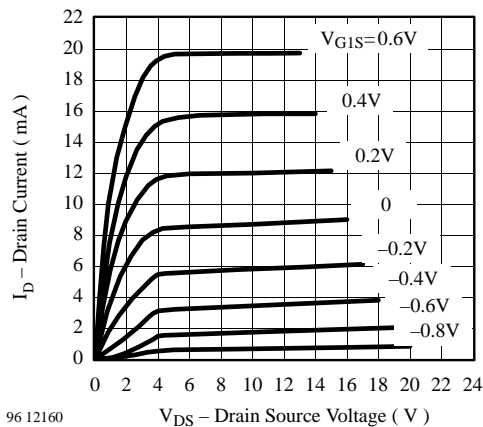

96 12160

Figure 2. Drain Current vs. Drain Source Voltage

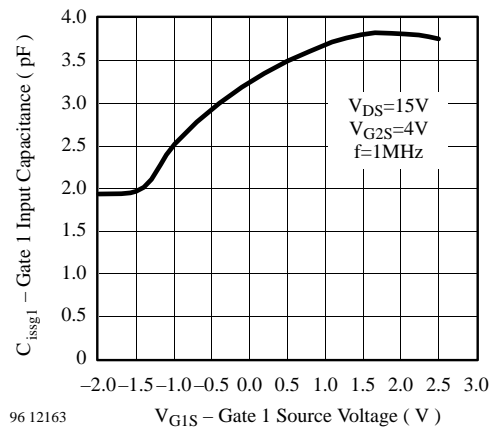

96 12163

Figure 5. Gate 1 Input Capacitance vs. Gate 1 Source Voltage

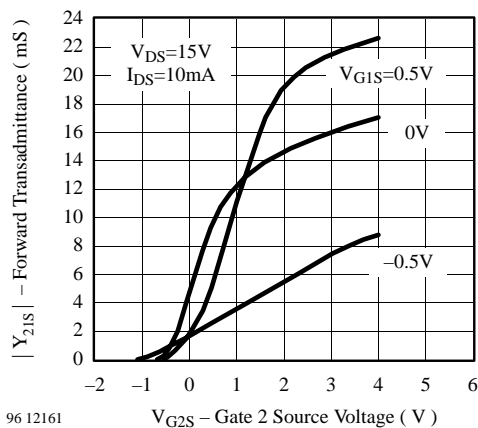

96 12161

Figure 3. Forward Transadmittance vs. Gate 2 Source Voltage

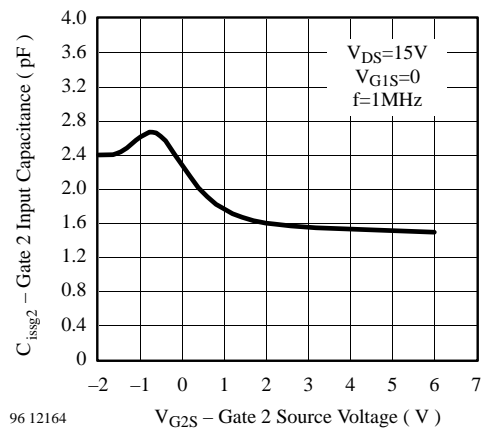

96 12164

Figure 6. Gate 2 Input Capacitance vs. Gate 2 Source Voltage

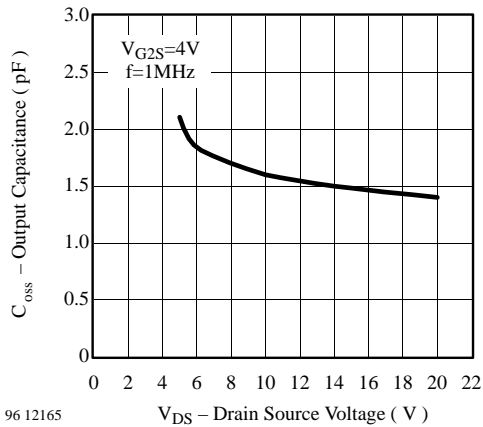

Figure 7. Output Capacitance vs. Drain Source Voltage

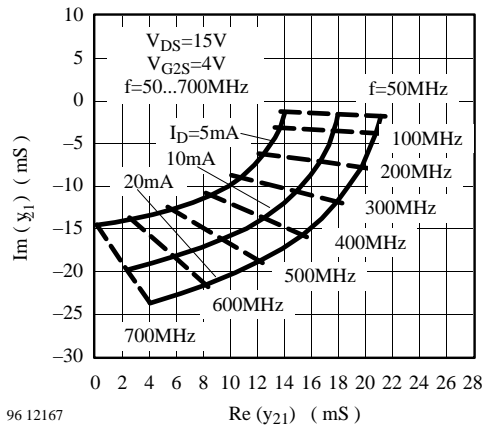

Figure 9. Short Circuit Forward Transfer Admittance

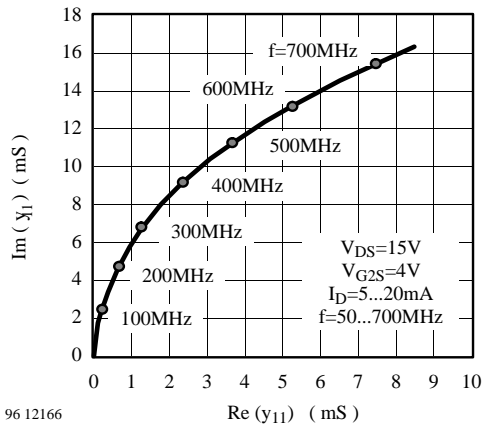

Figure 8. Short Circuit Input Admittance

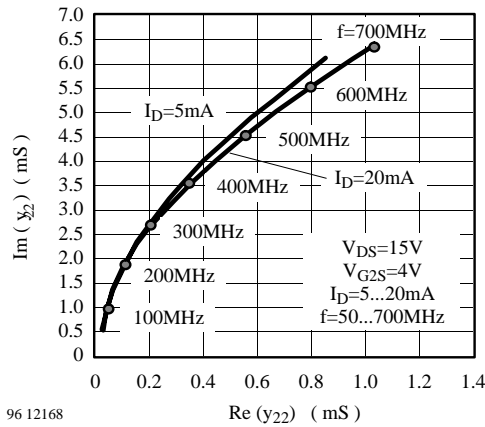

Figure 10. Short Circuit Output Admittance

$V_{DS} = 15 \text{ V}$, $I_D = 5 \text{ to } 20 \text{ mA}$, $V_{G2S} = 4 \text{ V}$, $Z_0 = 50 \Omega$

S_{11}

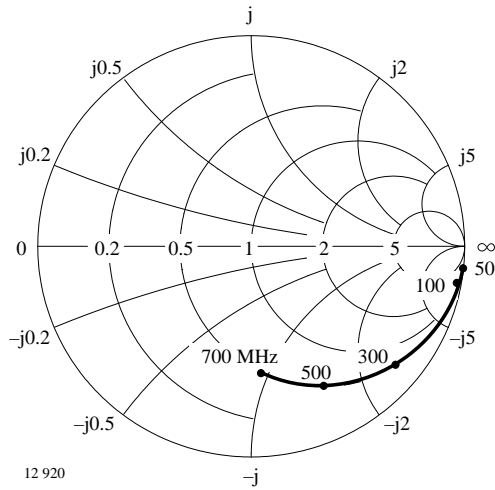

Figure 11. Input reflection coefficient

S_{12}

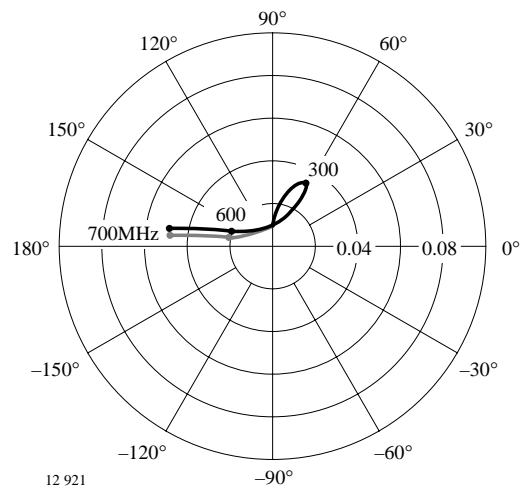

Figure 13. Reverse transmission coefficient

S_{21}

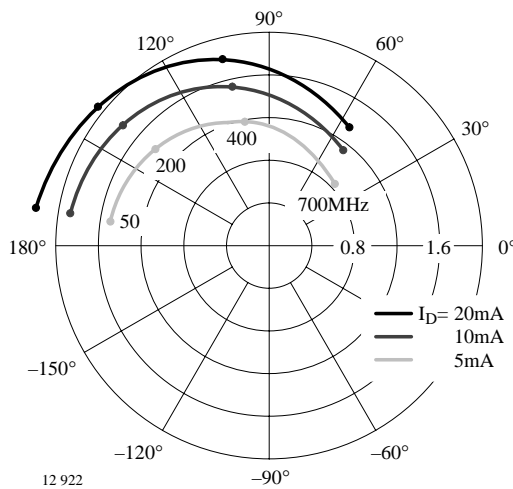

Figure 12. Forward transmission coefficient

S_{22}

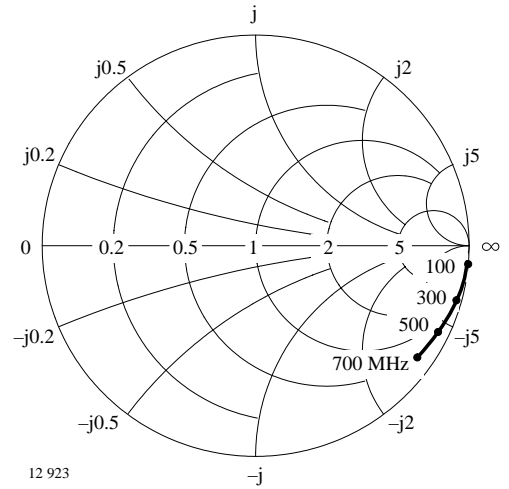

Figure 14. Output reflection coefficient

BF995

Vishay Telefunken



Dimensions in mm

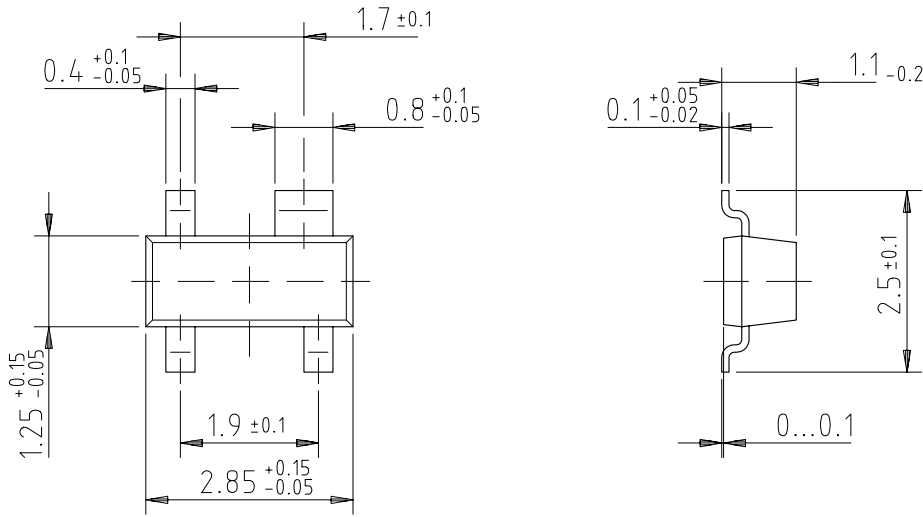

96 12240

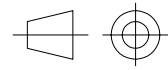

technical drawings
according to DIN
specifications

Ozone Depleting Substances Policy Statement

It is the policy of **Vishay Semiconductor GmbH** to

1. Meet all present and future national and international statutory requirements.
2. Regularly and continuously improve the performance of our products, processes, distribution and operating systems with respect to their impact on the health and safety of our employees and the public, as well as their impact on the environment.

It is particular concern to control or eliminate releases of those substances into the atmosphere which are known as ozone depleting substances (ODSs).

The Montreal Protocol (1987) and its London Amendments (1990) intend to severely restrict the use of ODSs and forbid their use within the next ten years. Various national and international initiatives are pressing for an earlier ban on these substances.

Vishay Semiconductor GmbH has been able to use its policy of continuous improvements to eliminate the use of ODSs listed in the following documents.

1. Annex A, B and list of transitional substances of the Montreal Protocol and the London Amendments respectively
2. Class I and II ozone depleting substances in the Clean Air Act Amendments of 1990 by the Environmental Protection Agency (EPA) in the USA
3. Council Decision 88/540/EEC and 91/690/EEC Annex A, B and C (transitional substances) respectively.

Vishay Semiconductor GmbH can certify that our semiconductors are not manufactured with ozone depleting substances and do not contain such substances.

We reserve the right to make changes to improve technical design and may do so without further notice.

Parameters can vary in different applications. All operating parameters must be validated for each customer application by the customer. Should the buyer use Vishay-Telefunken products for any unintended or unauthorized application, the buyer shall indemnify Vishay-Telefunken against all claims, costs, damages, and expenses, arising out of, directly or indirectly, any claim of personal damage, injury or death associated with such unintended or unauthorized use.

Vishay Semiconductor GmbH, P.O.B. 3535, D-74025 Heilbronn, Germany
Telephone: 49 (0) 7131 67 2831, Fax number: 49 (0) 7131 67 2423