

# N-Channel Dual Gate MOS-Fieldeffect Tetrode, Depletion Mode

Electrostatic sensitive device.  
Observe precautions for handling.



## Applications

Input- and mixer stages especially VHF TV-tuners.

## Features

- Integrated gate protection diodes
- High cross modulation performance
- Low noise figure
- High AGC-range
- Low feedback capacitance
- Low input capacitance

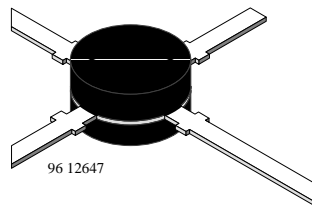
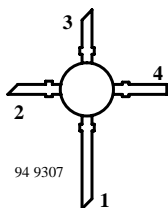

BF964S Marking: BF964S  
Plastic case (TO 50)  
1=Drain, 2=Source, 3=Gate 1, 4=Gate 2

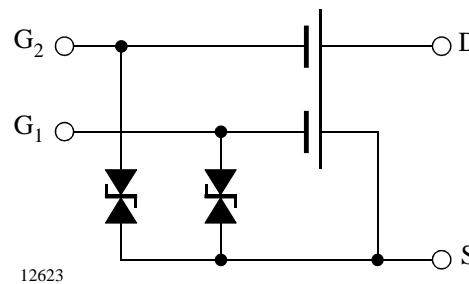

## Absolute Maximum Ratings

$T_{amb} = 25^{\circ}\text{C}$ , unless otherwise specified

Parameter	Test Conditions	Type	Symbol	Value	Unit
Drain - source voltage			$V_{DS}$	20	V
Drain current			$I_D$	30	mA
Gate 1/Gate 2 - source peak current			$\pm I_{G1/G2SM}$	10	mA
Total power dissipation	$T_{amb} \leq 60^{\circ}\text{C}$		$P_{tot}$	200	mW
Channel temperature			$T_{Ch}$	150	$^{\circ}\text{C}$
Storage temperature range			$T_{stg}$	-55 to +150	$^{\circ}\text{C}$

## Maximum Thermal Resistance

$T_{amb} = 25^{\circ}\text{C}$ , unless otherwise specified

Parameter	Test Conditions	Symbol	Value	Unit
Channel ambient	on glass fibre printed board (40 x 25 x 1.5) mm <sup>3</sup> plated with 35 $\mu\text{m}$ Cu	$R_{thChA}$	450	K/W

### Electrical DC Characteristics

$T_{amb} = 25^{\circ}\text{C}$ , unless otherwise specified

Parameter	Test Conditions	Type	Symbol	Min	Typ	Max	Unit
Drain - source breakdown voltage	$I_D = 10 \mu\text{A}$ , $-V_{G1S} = -V_{G2S} = 4 \text{ V}$		$V_{(BR)DS}$	20			V
Gate 1 - source breakdown voltage	$\pm I_{G1S} = 10 \text{ mA}$ , $V_{G2S} = V_{DS} = 0$		$\pm V_{(BR)G1SS}$	8		14	V
Gate 2 - source breakdown voltage	$\pm I_{G2S} = 10 \text{ mA}$ , $V_{G1S} = V_{DS} = 0$		$\pm V_{(BR)G2SS}$	8		14	V
Gate 1 - source leakage current	$\pm V_{G1S} = 5 \text{ V}$ , $V_{G2S} = V_{DS} = 0$		$\pm I_{G1SS}$			50	nA
Gate 2 - source leakage current	$\pm V_{G2S} = 5 \text{ V}$ , $V_{G1S} = V_{DS} = 0$		$\pm I_{G2SS}$			50	nA
Drain current	$V_{DS} = 15 \text{ V}$ , $V_{G1S} = 0$ , $V_{G2S} = 4 \text{ V}$	BF964S	$I_{DSS}$	4		18	mA
		BF964SA	$I_{DSS}$	4		10.5	mA
		BF964SB	$I_{DSS}$	9.5		18	mA
Gate 1 - source cut-off voltage	$V_{DS} = 15 \text{ V}$ , $V_{G2S} = 4 \text{ V}$ , $I_D = 20 \mu\text{A}$		$-V_{G1S(OFF)}$			2.5	V
Gate 2 - source cut-off voltage	$V_{DS} = 15 \text{ V}$ , $V_{G1S} = 0$ , $I_D = 20 \mu\text{A}$		$-V_{G2S(OFF)}$			2.0	V

### Electrical AC Characteristics

$V_{DS} = 15 \text{ V}$ ,  $I_D = 10 \text{ mA}$ ,  $V_{G2S} = 4 \text{ V}$ ,  $f = 1 \text{ MHz}$ ,  $T_{amb} = 25^{\circ}\text{C}$ , unless otherwise specified

Parameter	Test Conditions	Symbol	Min	Typ	Max	Unit
Forward transadmittance		$ y_{21s} $	15	18.5		mS
Gate 1 input capacitance		$C_{issg1}$		2.5	3.0	pF
Gate 2 input capacitance	$V_{G1S} = 0$ , $V_{G2S} = 4 \text{ V}$	$C_{issg2}$		1.2		pF
Feedback capacitance		$C_{rss}$		25	35	fF
Output capacitance		$C_{oss}$		1.0	1.3	pF
Power gain	$G_S = 2 \text{ mS}$ , $G_L = 0.5 \text{ mS}$ , $f = 200 \text{ MHz}$	$G_{ps}$		25		dB
AGC range	$V_{G2S} = 4 \text{ to } -2 \text{ V}$ , $f = 200 \text{ MHz}$	$\Delta G_{ps}$	50			dB
Noise figure	$G_S = 2 \text{ mS}$ , $G_L = 0.5 \text{ mS}$ , $f = 200 \text{ MHz}$	F		1.0		dB

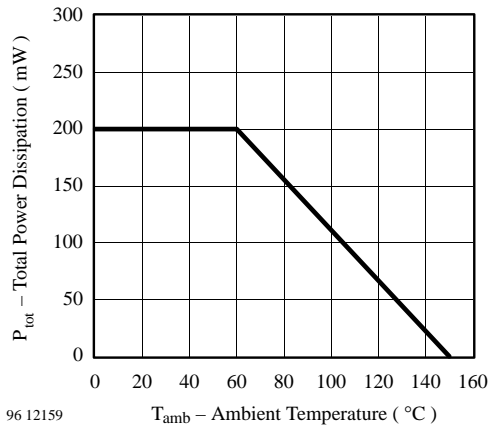
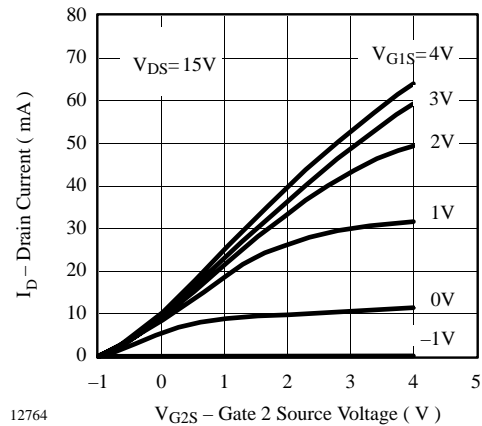
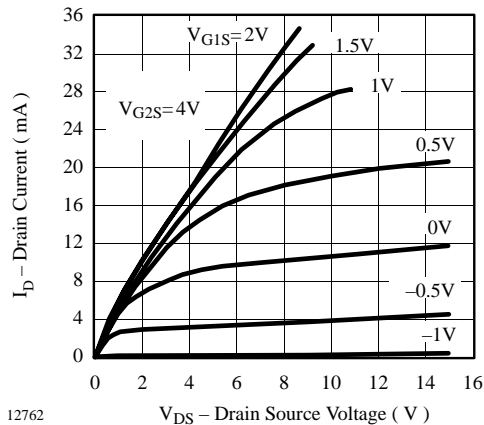
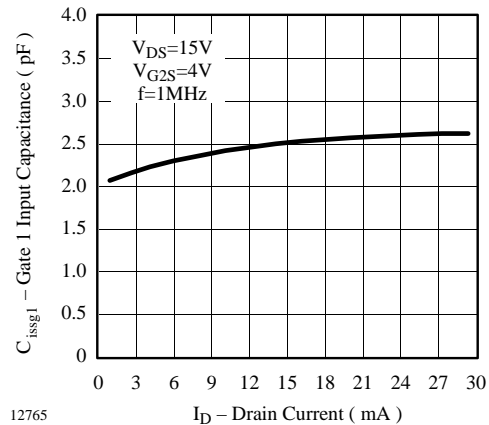
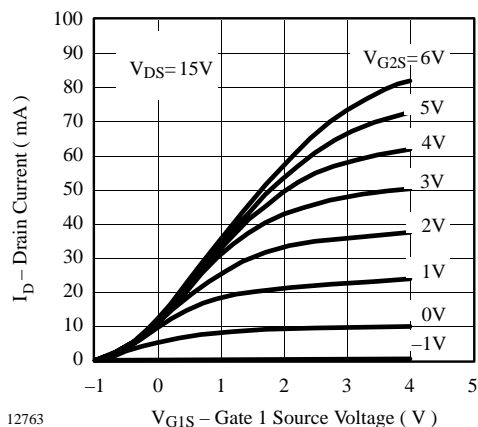
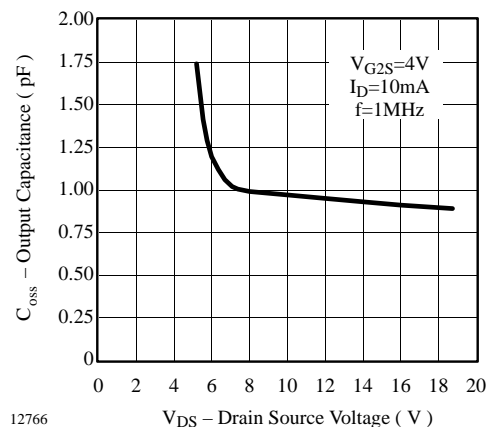
**Typical Characteristics** ( $T_{amb} = 25^{\circ}\text{C}$  unless otherwise specified)

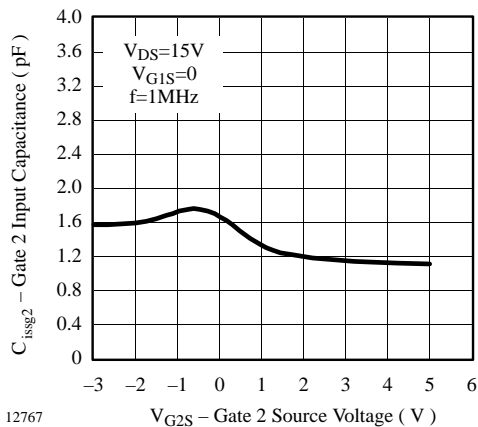
**Figure 1. Total Power Dissipation vs. Ambient Temperature**

**Figure 4. Drain Current vs. Gate 2 Source Voltage**

**Figure 2. Drain Current vs. Drain Source Voltage**

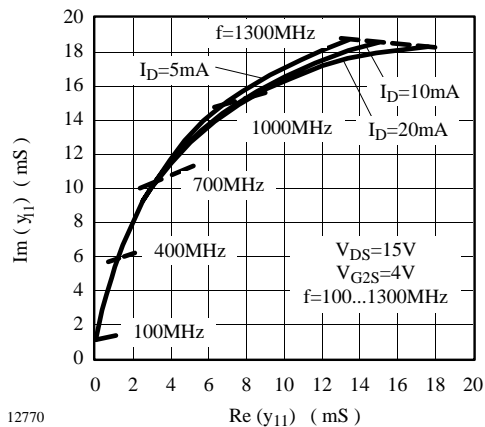
**Figure 5. Gate 1 Input Capacitance vs. Drain Current**

**Figure 3. Drain Current vs. Gate 1 Source Voltage**

**Figure 6. Output Capacitance vs. Drain Source Voltage**



12767

Figure 7. Gate 2 Input Capacitance vs. Gate 2 Source Voltage



12770

Figure 10. Short Circuit Input Admittance

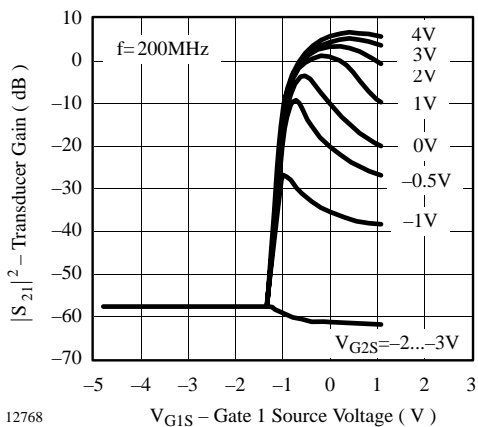

12768

Figure 8. Transducer Gain vs. Gate 1 Source Voltage

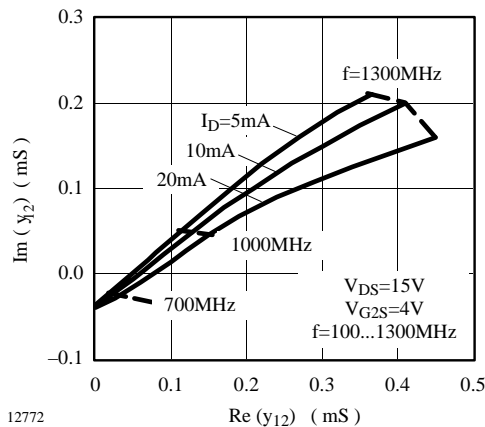

12772

Figure 11. Short Circuit Reverse Transfer Admittance

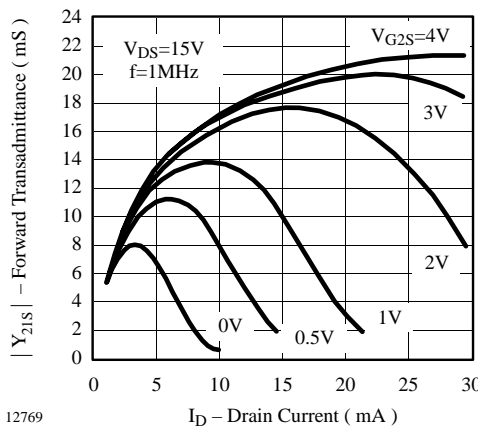

12769

Figure 9. Forward Transadmittance vs. Drain Current

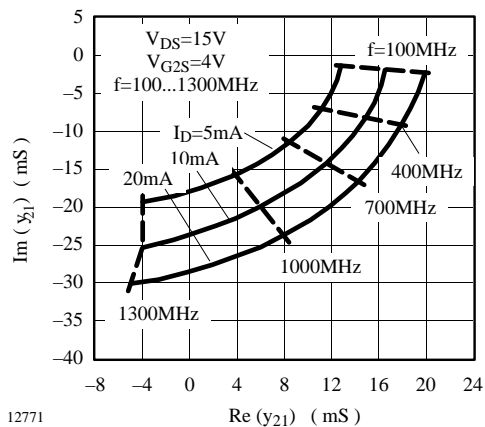

12771

Figure 12. Short Circuit Forward Transfer Admittance

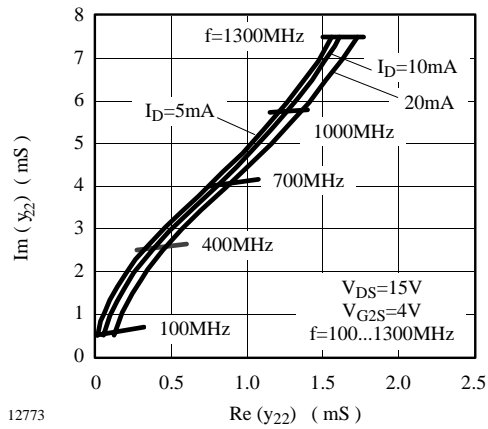

Figure 13. Short Circuit Output Admittance

$V_{DS} = 15 \text{ V}$ ,  $I_D = 5 \text{ to } 20 \text{ mA}$ ,  $V_{G2S} = 4 \text{ V}$ ,  $Z_0 = 50 \Omega$

$S_{11}$

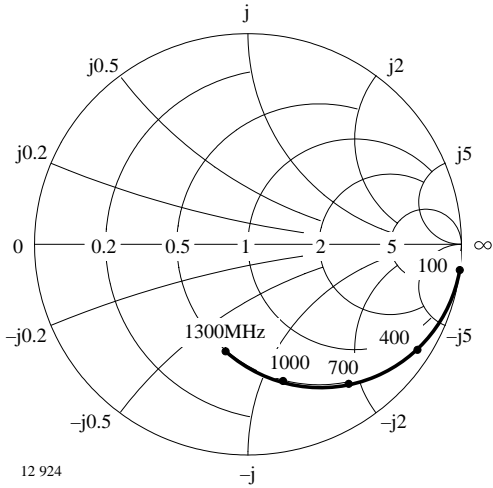

Figure 14. Input reflection coefficient

$S_{12}$

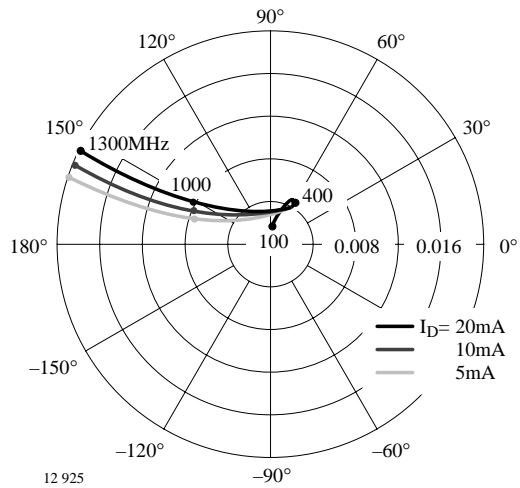

Figure 16. Reverse transmission coefficient

$S_{21}$

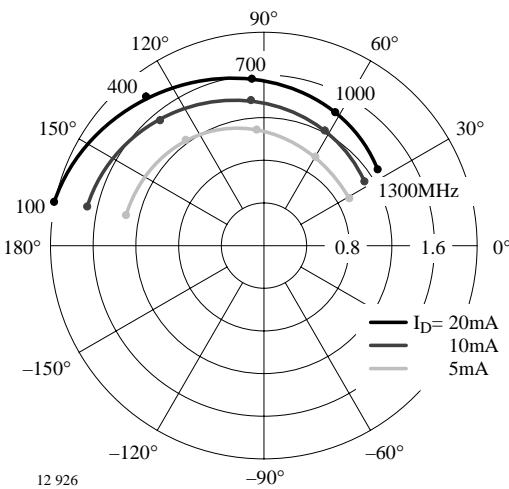

Figure 15. Forward transmission coefficient

$S_{22}$

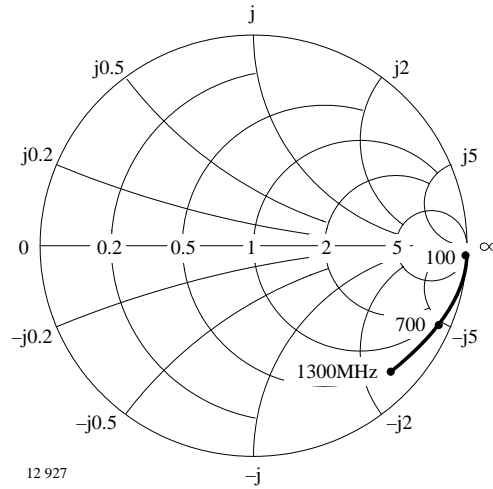
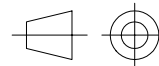
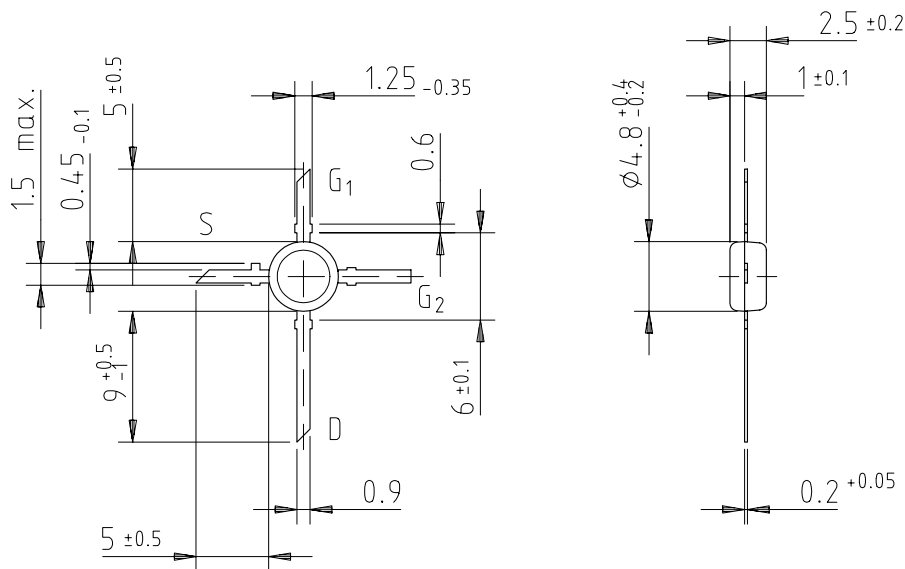

Figure 17. Output reflection coefficient

**Dimensions in mm**



96 12242

technical drawings  
according to DIN  
specifications

**Ozone Depleting Substances Policy Statement**

It is the policy of **Vishay Semiconductor GmbH** to

1. Meet all present and future national and international statutory requirements.
2. Regularly and continuously improve the performance of our products, processes, distribution and operating systems with respect to their impact on the health and safety of our employees and the public, as well as their impact on the environment.

It is particular concern to control or eliminate releases of those substances into the atmosphere which are known as ozone depleting substances (ODSs).

The Montreal Protocol (1987) and its London Amendments (1990) intend to severely restrict the use of ODSs and forbid their use within the next ten years. Various national and international initiatives are pressing for an earlier ban on these substances.

**Vishay Semiconductor GmbH** has been able to use its policy of continuous improvements to eliminate the use of ODSs listed in the following documents.

1. Annex A, B and list of transitional substances of the Montreal Protocol and the London Amendments respectively
2. Class I and II ozone depleting substances in the Clean Air Act Amendments of 1990 by the Environmental Protection Agency (EPA) in the USA
3. Council Decision 88/540/EEC and 91/690/EEC Annex A, B and C (transitional substances) respectively.

**Vishay Semiconductor GmbH** can certify that our semiconductors are not manufactured with ozone depleting substances and do not contain such substances.

**We reserve the right to make changes to improve technical design and may do so without further notice.**

Parameters can vary in different applications. All operating parameters must be validated for each customer application by the customer. Should the buyer use Vishay-Telefunken products for any unintended or unauthorized application, the buyer shall indemnify Vishay-Telefunken against all claims, costs, damages, and expenses, arising out of, directly or indirectly, any claim of personal damage, injury or death associated with such unintended or unauthorized use.

Vishay Semiconductor GmbH, P.O.B. 3535, D-74025 Heilbronn, Germany  
Telephone: 49 (0) 7131 67 2831, Fax number: 49 (0) 7131 67 2423