



# Chunghwa Picture Tubes, Ltd.

## Product Specification

To : Studio Technology Co.,Ltd  
Date : 2009/02/23

**TFT LCD**

**CLAA089NA0ACW**

ACCEPTED BY :

APPROVED BY	CHECKED BY	PREPARED BY
Ronald Huang	Roger Liu	Carol Shen

Prepared by :

Product Planning Management Division

**CHUNGHWA PICTURE TUBES, LTD.**

1127 Hopin Rd., Padeh, Taoyuan, Taiwan 334, R.O.C.  
TEL: +886-3-3675151 FAX: +886-3-377-3003

Doc.No:	CLAA089NA0ACW-HAOSHENG-V1-20090223	Issue Date:	20090223
---------	------------------------------------	-------------	----------



## CONTENTS

1. OVERVIEW.....	4
2. ABSOLUTE MAXIMUM RATINGS .....	5
3. ELECTRICAL CHARACTERISTICS.....	6
4. INTERFACE CONNECTION:.....	8
5. INPUT SIGNAL .....	10
6. BLOCK DIAGRAM.....	12
7. MECHANICAL DIMENSION .....	13
8. OPTICAL CHARACTERISTICS.....	15
9. RELIABILITY TEST CONDITIONS.....	18

Studio Technology Co., Ltd

## 1. OVERVIEW

CLAA089NA0ACW is 8.9" color TFT-LCD (Thin Film Transistor Liquid Crystal Display) module composed of LCD panel, driver ICs, control circuit and LED backlight.

The 8.9" screen produces 1024× RGB X600 resolution image. By applying 6 bits digital data, 262K color images are displayed. The LCD is driven by a single input voltage (3.3 V and 5V).

General specifications are summarized in the following table:

ITEM	SECIFICATION
Display Area (mm)	195.072 (H) × 114.3 (V)
Number of Pixels(dot)	1024(H) × 3(RGB)× 600(V)
Pixel Pitch (mm)	0.1905 (H) × 0.1905 (V)
Color Pixel Arrangement	RGB vertical stripe
Display Mode	Normally white, TN
Number of Color	262,144
Viewing Direction	6 o'clock
Response Time (Tr+Tf)	20 ms (typ.)
Brightness(cd/m <sup>2</sup> )	220 nit (typ.)
Viewing Angle (CR ≥ 10)	140 degree (Horizontal) 120 degree (Vertical)
Electrical Interface	LVDS
Power Consumption(W)	2.9 W (typ.)
Outline Dimension(mm)	210(W) × 127.8(H) × 5.2(D)
Module Weight(g)	190(typ.)
BL unit	LED
Surface Treatment	Anti-Glare, Surface hardness: 3H

## 2. ABSOLUTE MAXIMUM RATINGS

ITEM	SYMBOL	MIN.	MAX.	UNIT	NOTE
Power Supply Voltage for LCD	V <sub>cc</sub>	-0.3	4.0	V	
Power Supply Voltage for LED	V <sub>dd</sub>	-0.3	6.0	V	
Signal Input Voltage	RxIN0+ ~ RxIN2+ RxIN0- ~ RxIN2- Rx CLK IN +/-	-0.3	V <sub>cc</sub> + 0.3	V	
Static Electricity	VESDc	-200	+200	V	【Note2】
	VESDm	-15K	+15K	V	
ICC Rush Current	IRUSH	-	1	A	【Note3】
Operation Temperature	T <sub>op</sub>	-20	70	°C	【Note1】
Storage Temperature	T <sub>stg</sub>	-30	80	°C	【Note1】

【Note】

【Note 1】 If users use the product out off the environmental operation range (temperature and humidity), it will have visual quality concerns.

【Note 2】 Test Condition: IEC 61000-4-2

VESDc : Contact discharge to input connector

VESDm : Discontact discharge to module

【Note 3】 The input pulse-current measurement system is as below:

Control signal: High (+3.3V)→Low (GND)

Supply Voltage of rising time should be from R3 and C2 tune to 550 μs.

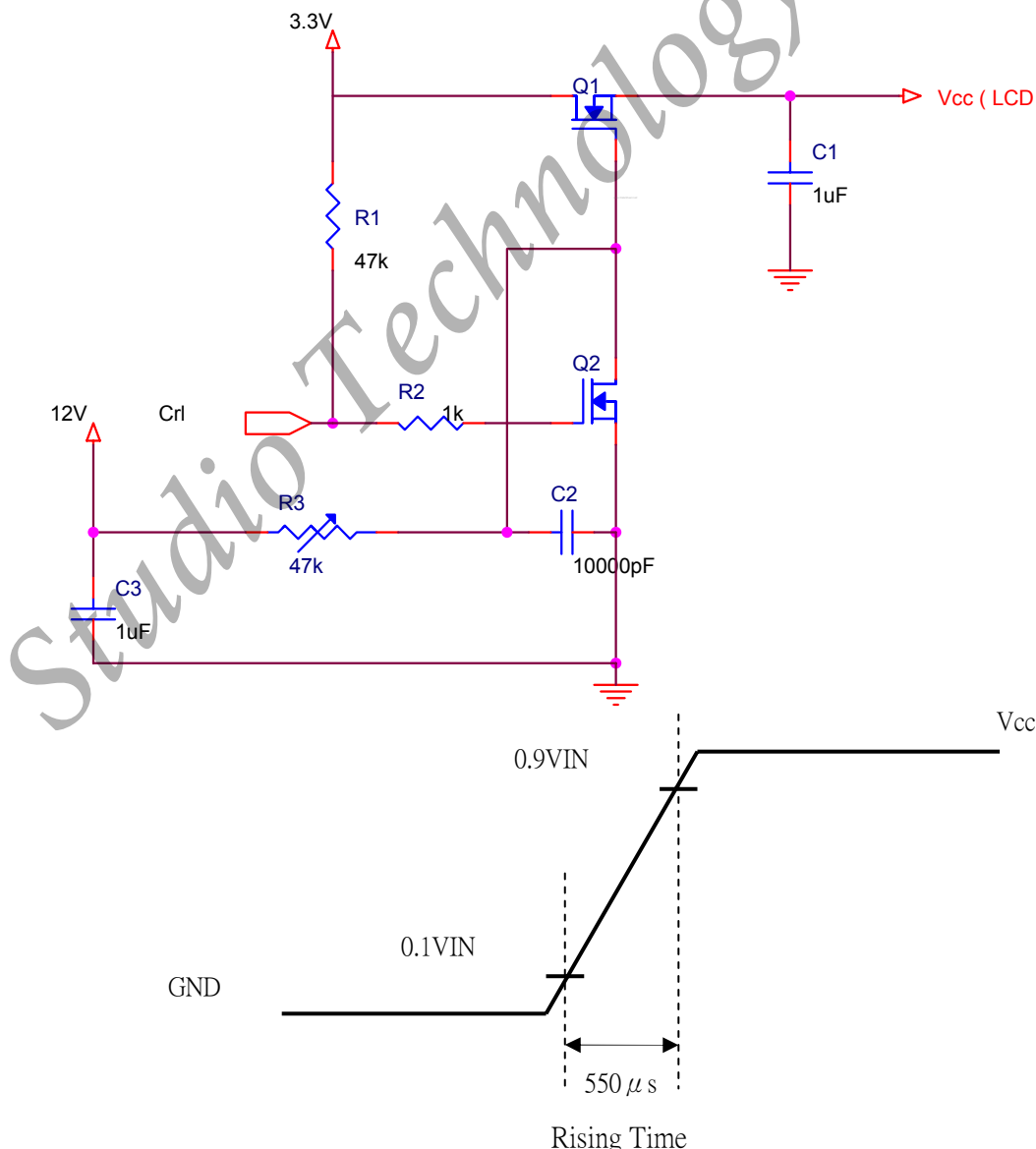

### 3. ELECTRICAL CHARACTERISTICS

#### 3.1 TFT-LCD Power Supply Voltage

(Ta=25°C)

ITEM	SYMBOL	MIN.	Typ.	MAX.	UNIT	NOTE
Power Supply Voltage For LCD	VCC	3.0	3.3	3.6	V	
Power Supply Voltage For LED	VLED	4.5	5	5.5	V	
Logic Input Voltage	VIN	0	-	2.4	V	
	VCM	0.3	1.2	2.1	V	【Note1】
	VID	0.1	-	0.6	V	【Note1】
	VTH	-	-	100	mV	【Note1】
	VTL	-100	-	-	mV	【Note1】
ADJ Input Voltage	VIH	3.0		3.3	V	
	VIL	GND		0.3	V	

【Note】

【Note1】 LVDS signal

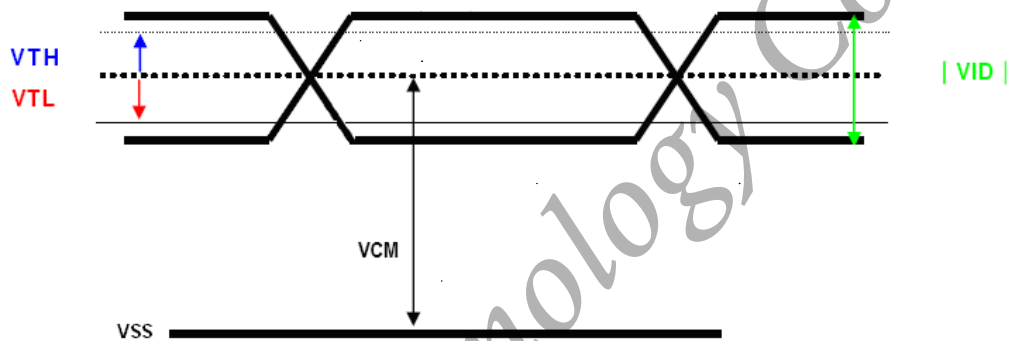

Note:

VCM: Common Mode Voltage Offset

| VID | : Differential Input Voltage

VTH: Differential Input High Threshold Voltage

VTL: Differential Input Low Threshold Voltage

### 3.2 TFT-LCD Current consumption

ITEM	SYMBOL	MIN.	TYP.	MAX.	UNIT	NOTE
LCD Power Current	ICC	--	240	300	mA	【Note1】
LED Power Current	IDD	--	420	480	mA	【Note2】

【Note】

【Note1】 Typical: Under 64 gray pattern  
Maximum: Under black pattern



(a) 64 Gray Pattern



(b) Black Pattern

【Note2】 Typical: VDD = 5V  
Maximum: VDD = 4.5V

### 3.3 Power and Signal sequence

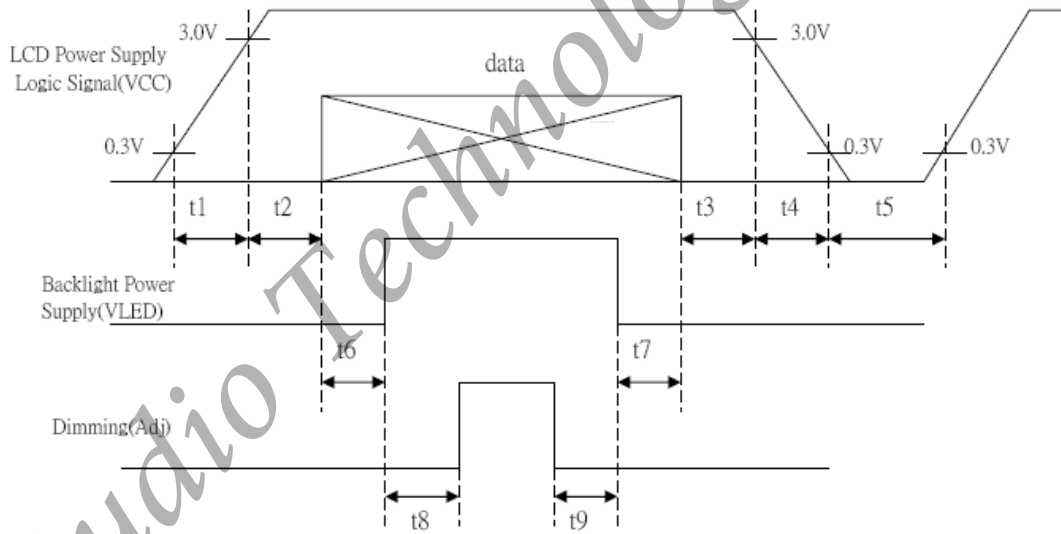

- $0.5 < t1 \leq 10\text{ms}$
- $0 < t2 \leq 50\text{ms}$
- $0 < t3 \leq 50\text{ms}$
- $0 < t4 \leq 10\text{ms}$
- $200\text{ms} \leq t5$
- $200\text{ms} \leq t6$
- $200\text{ms} \leq t7$
- $10\text{ms} \leq t8$
- $10\text{ms} \leq t9$

## 4. INTERFACE CONNECTION:

### 4.1 Pin Assignment

PIN NO.	SYMBOL	DESCRIPTION
1	AVSS	Power Ground
2	VCC	Power Supply for Digital circuit
3	VCC	Power Supply for Digital circuit
4	VEDID	3.3V
5	ADJ	Brightness control for LED B/L
6	CLKEDID	EDID Clock Signal
7	DATAEDID	EDID Data Signal
8	RXIN0-	Negative LVDS differential data inputs
9	RXIN0+	Positive LVDS differential data inputs
10	AVSS	Power Ground
11	RXIN1-	Negative LVDS differential data inputs
12	RXIN1+	Positive LVDS differential data inputs
13	AVSS	Power Ground
14	RXIN2-	Negative LVDS differential data inputs
15	RXIN2+	Positive LVDS differential data inputs
16	AVSS	Power Ground
17	RXCLK-	Negative LVDS differential clock inputs
18	RXCLK+	Positive LVDS differential clock inputs
19	AVSS	Power Ground
20	NC	NC
21	NC	NC
22	AVSS	Power Ground
23	AVSS	Power Ground
24	VLED	Power Supply for LED(VLED=5.0±0.5)
25	VLED	Power Supply for LED(VLED=5.0±0.5)
26	VLED	Power Supply for LED(VLED=5.0±0.5)
27	NC	NC
28	NC	NC
29	NC	NC
30	NC	NC

[Note]:

- 1) To reserve NC pin, don't make it connect with GND or any other signal.
- 2) AVSS pin must be connected with GND. Don't let it be an empty pin.
- 3) Adjust control pin (ADJ) controls brightness. The bigger pulse duty, the brighter luminance.

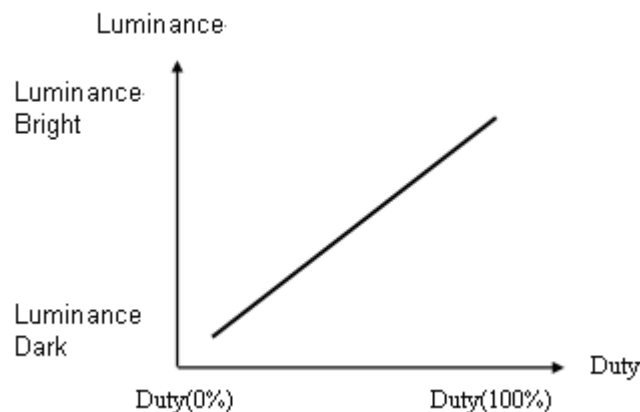



4) ADJ signal=0~3.3V, operation frequency: 25KHZ±5KHz

$F=25\text{KHz} \pm 5\text{KHz}$  ·  $T=0.04\text{ms}$

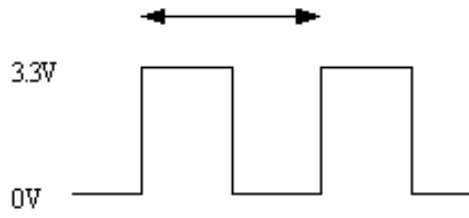

5) The ADJ should pull-high if not adjust brightness, this pin can't floating.

Studio Technology Co., Ltd

### 5. INPUT SIGNAL

#### 5.1 Timing Specification

Item		SYMBOL	MIN.	TYP.	MAX.	UNIT	
LVDS	CLK frequency	fCLKin	39.05	45	51.42	MHz	
LCD Input timing	Horizontal	Horizontal Period	t <sub>H</sub>	1160	1200	1240	tCLK
		Horizontal Valid	t <sub>HA</sub>	1024	<b>1024</b>	1024	tCLK
		Horizontal Blank	t <sub>HB</sub>	136	176	216	tCLK
	Vertical	Frame	fV	55	60	65	Hz
		Vertical Period	t <sub>V</sub>	612	625	638	t <sub>H</sub>
		Vertical Valid	t <sub>VA</sub>	600	<b>600</b>	600	t <sub>H</sub>
		Vertical Blank	t <sub>VB</sub>	12	25	38	t <sub>H</sub>

#### 5.2 Timing Chart

(1) Input Timing Diagram  
Horizontal Timing:

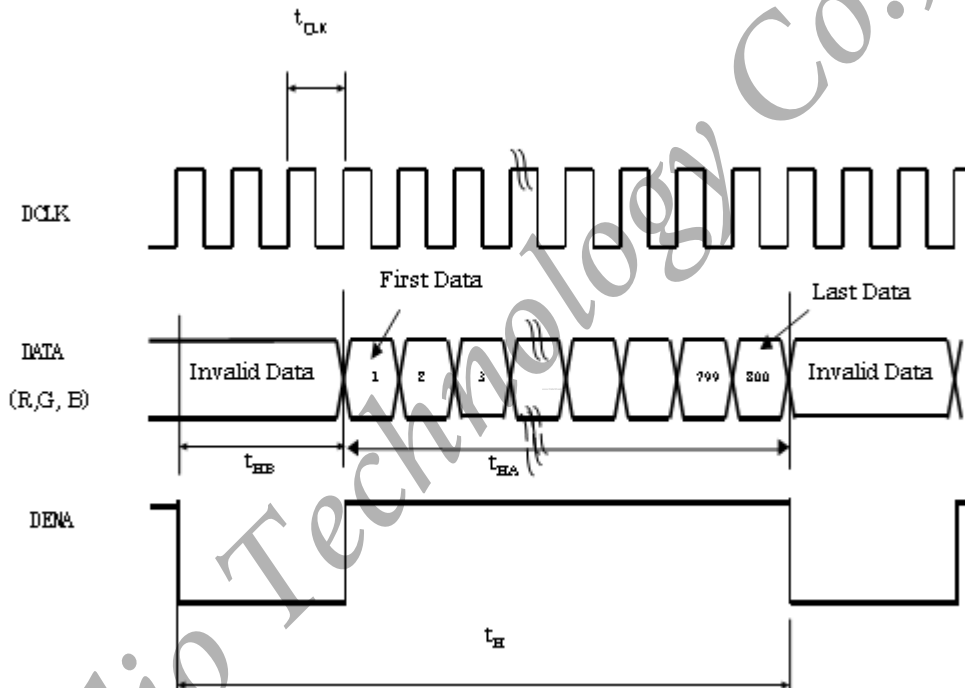

Vertical Timing:

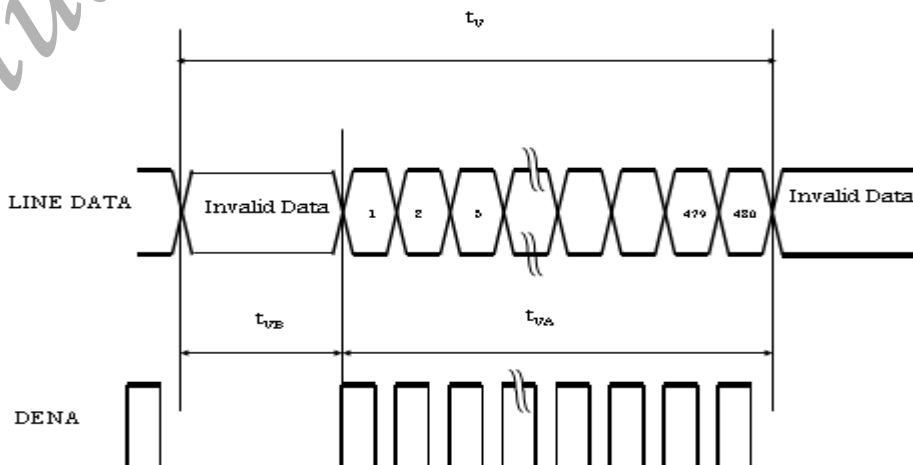

(2) LVDS Input Data Mapping

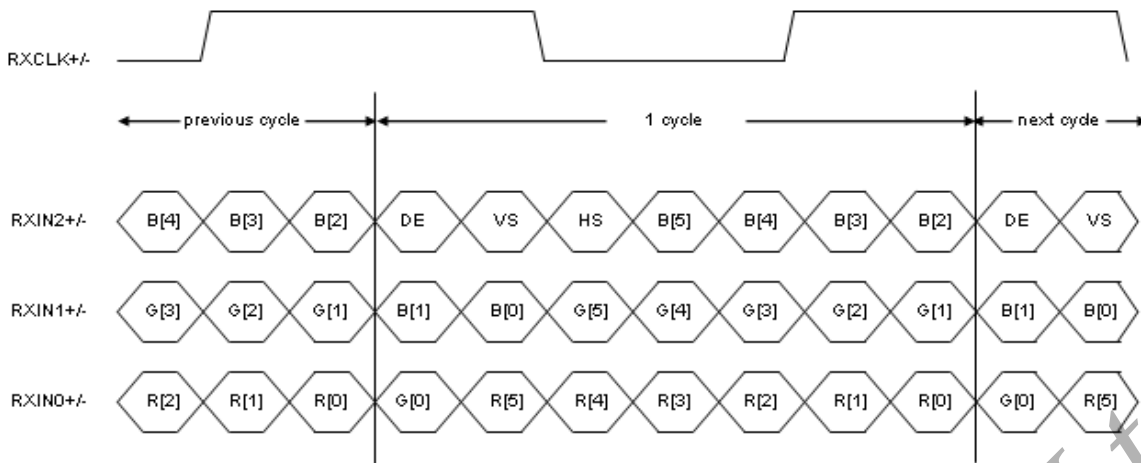

Note: R/G/B[7] are MSB and R/G/B[0] are LSB.

Studio Technology Co., Ltd

### 6. BLOCK DIAGRAM

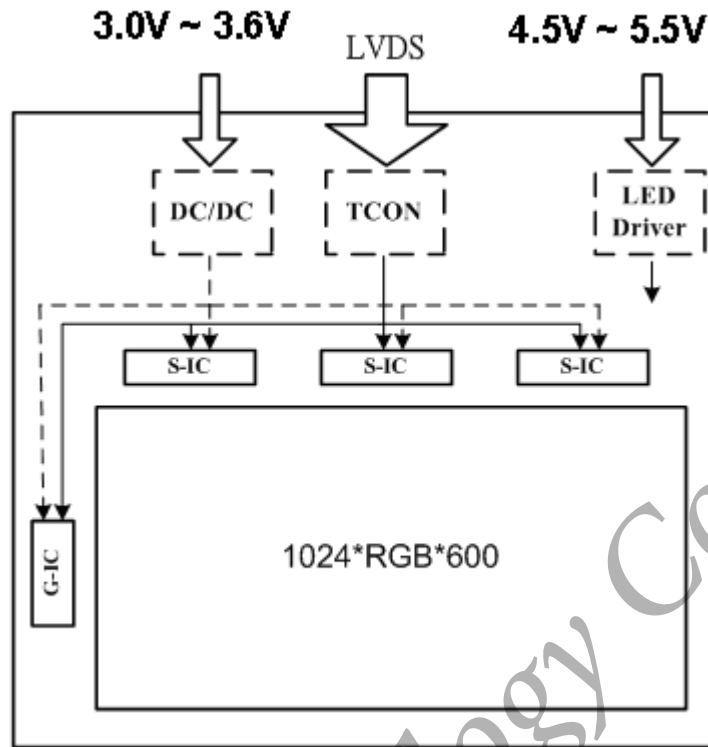

Studio Technology Co., Ltd

## 7. MECHANICAL DIMENSION

### 7.1 Front Side

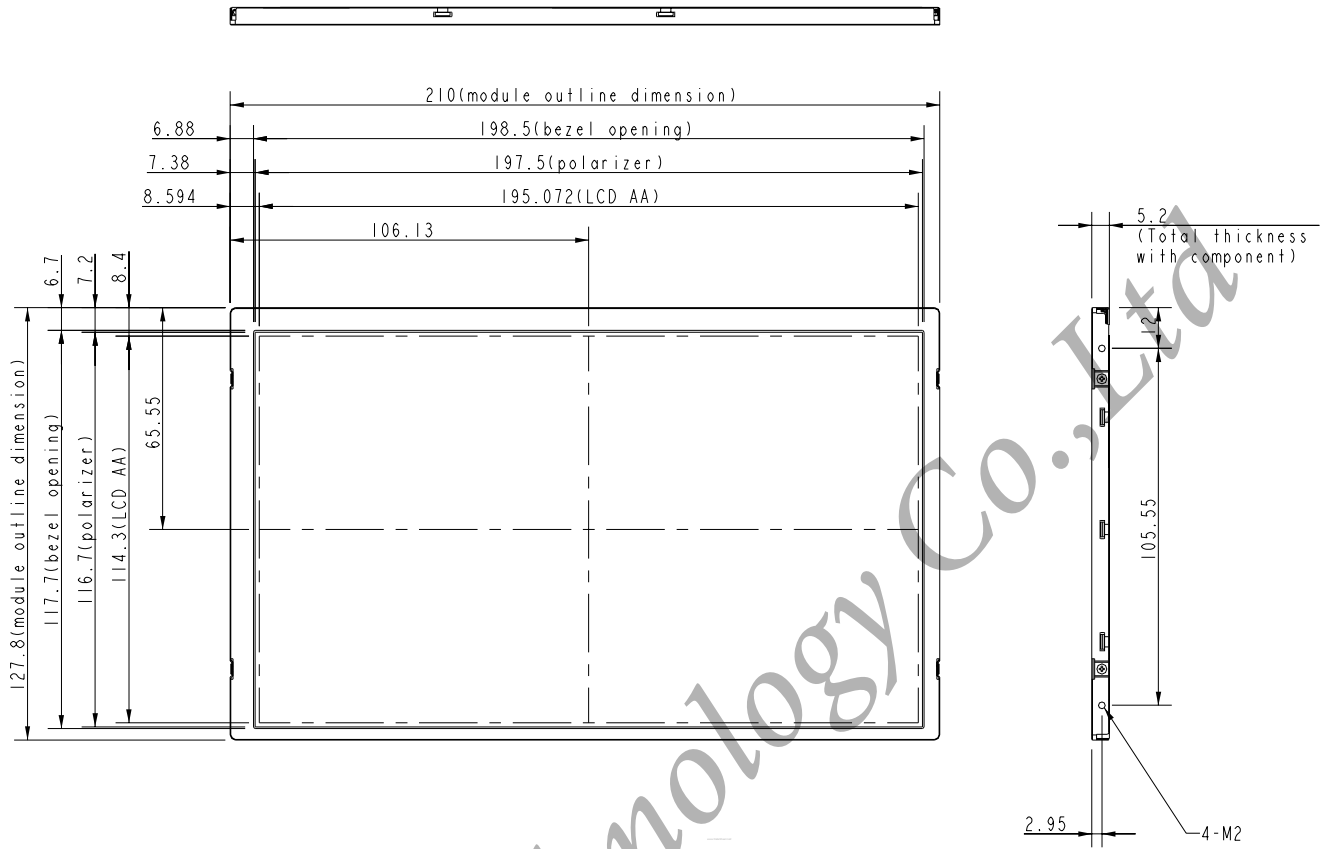

[Note]: Tolerance is  $\pm 0.3\text{mm}$  unless noted

## 7.2 Rear Side

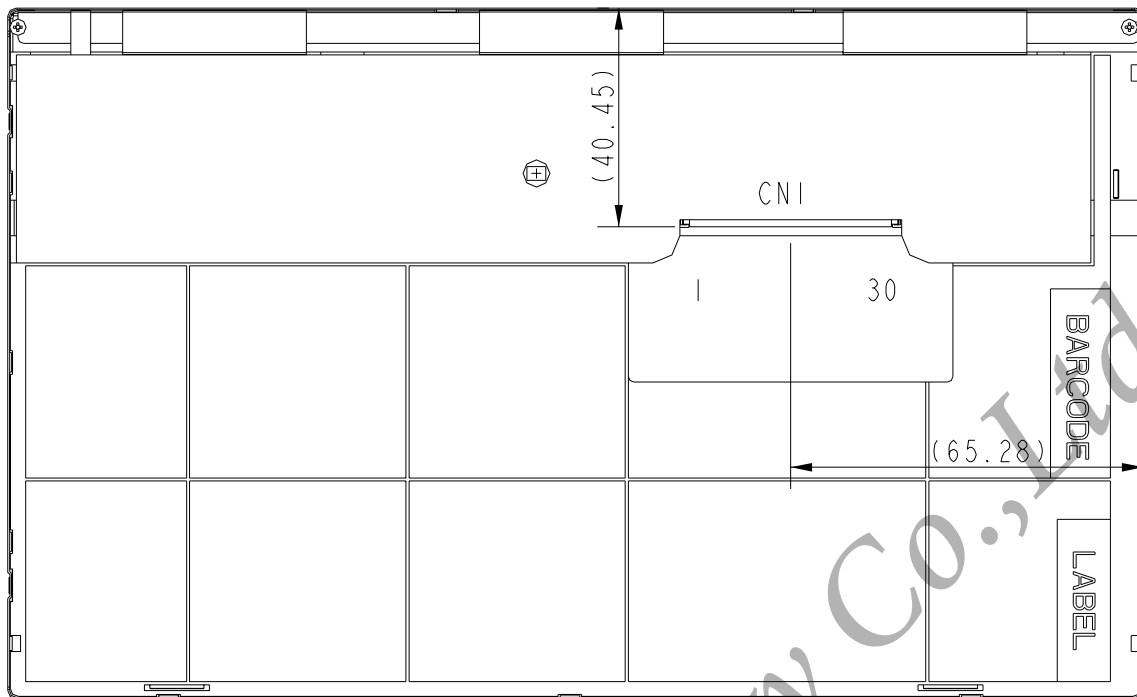

- [Note]:
1. Tolerance is  $\pm 0.3\text{mm}$  unless noted
  2. CN1: STARCONN 093F30
  3. SIDE MOUNT M2 SCREW TORQUE Max. 2.5 kgf\*cm
  4. SIDE MOUNT M2 SCREW Length Max. 2.0 mm

## 8. OPTICAL CHARACTERISTICS

ITEM		SYMBOL	CONDITION	MIN.	TYP.	MAX.	UNIT	Remarks
Contrast Ratio		CR	Point-5	300	400	-	-	*1)*2)*3)
Luminance		Lw	Point-5	180	220		cd/m <sup>2</sup>	*1)*3)
Luminance Uniformity		ΔL		70	80	-	%	*1)*3)
Response Time (White - Black)		Tr+ Tf	Point-5	-	20	35	ms	*1)*3)*5)
Viewing Angle	Horizontal	ψ	CR ≥ 10 Point-5	120	140	-	°	*1)*2)*4)
	Vertical	θ		100	120	-	°	
Color Coordinate	White	Wx Wy	Point-5	0.273 0.289	0.313 0.329	0.353 0.369	-	*1)*3)
	Red	Rx Ry		0.554 0.297	0.594 0.337	0.634 0.377		
	Green	Gx Gy		0.299 0.548	0.339 0.588	0.379 0.628		
	Blue	Bx By		0.108 0.055	0.148 0.095	0.188 0.135		

[Note]:

\*1) Measurement condition: 25°C±2°C, 60%±10%RH, under 10 Lux in the dark room. Measuring with BM-5A (TOPCON) under viewing angle 2°, V<sub>CC</sub>=3.3V, V<sub>adj</sub>=3.3V, Duty 100%, after lighting 10 mins.

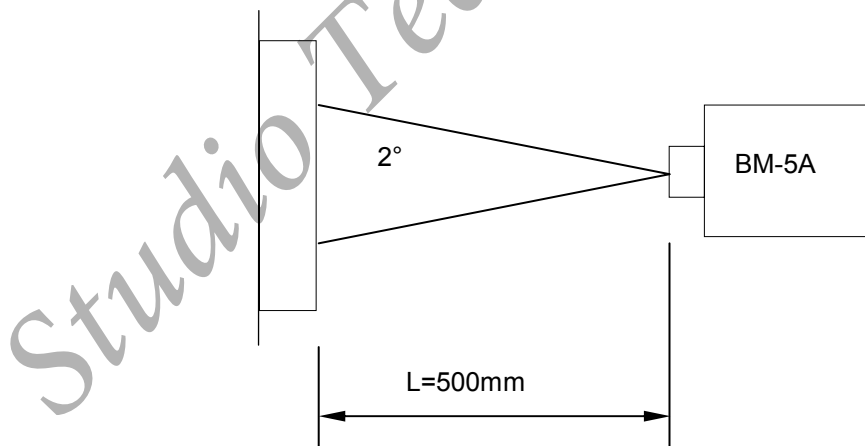

\*2) Definition of contrast ratio:

Contrast Ratio (CR) = (White) Luminance of ON / (Black) Luminance of OFF

\*3) Definition of Luminance: Measuring white luminance on the point 5 as figure 8-1  
 Definition of Luminance Uniformity: Measuring white luminance on the point1 to 9 as figure 8-1  
 $\Delta L = [L(\text{Min})/L(\text{Max})] \times 100\%$

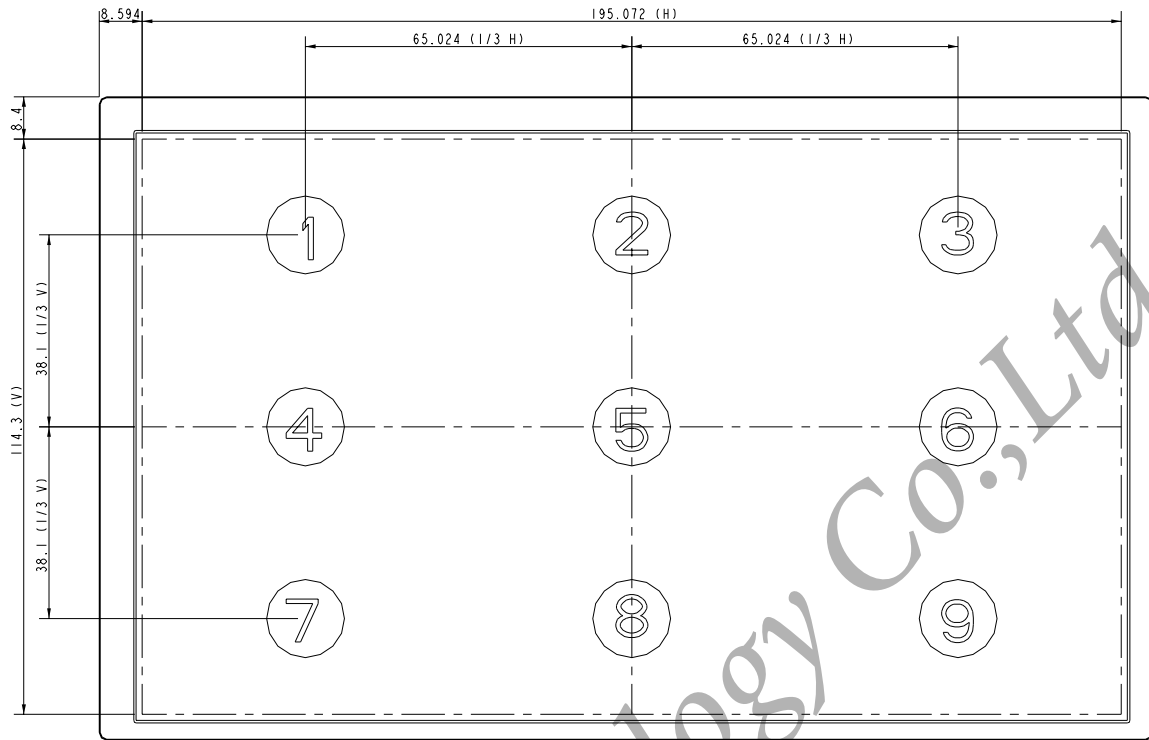

Fig. 8-1 Measuring point

\*4) Definition of Viewing Angle( $\theta, \psi$ ):

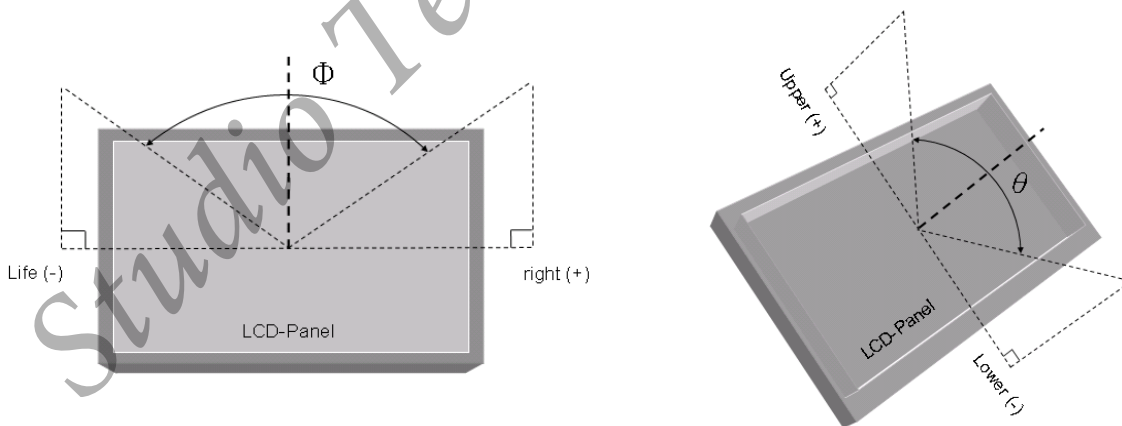

Fig. 8-2 Definition of Viewing Angle



\*5) Definition of Response Time

The response time is defined as the time interval between the 10% and 90% amplitudes. Refer to the figure 8-3 as below.

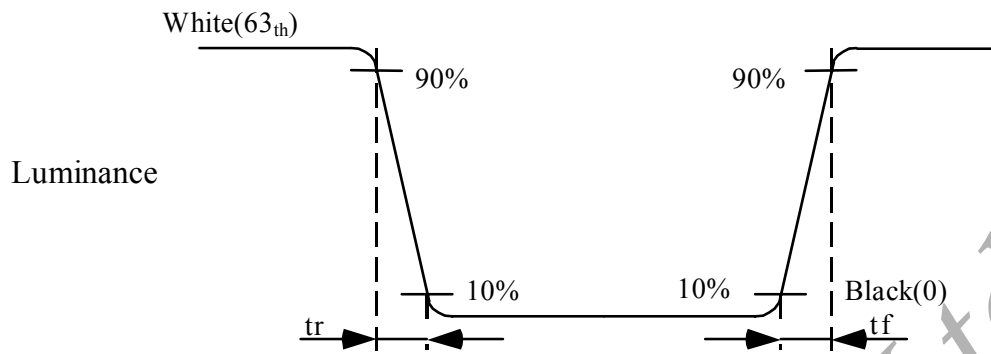

Fig. 8-3 Definition of Response Time

Studio Technology Co., Ltd

## 9. RELIABILITY TEST CONDITIONS

### 9.1 Temperature and Humidity

TEST ITEMS	CONDITIONS
High Temperature Operation	70° C ; 240 Hrs
High Temperature Storage	80° C ; 240 Hrs
High Temperature High Humidity Operation	60° C ; 90% RH ; 240 Hrs (No condensation)
Low Temperature Operation	-20° C ; 240Hrs
Low Temperature Storage	-30° C ; 240 Hrs
Thermal Shock	-30° C (0.5Hr)~80° C (0.5Hr) 200 CYCLE

### 9.2 Shock & Vibration

TEST ITEMS	CONDITIONS
SHOCK (NON-OPERATION)	<ul style="list-style-type: none"> <li>● Shock level: 980m/s<sup>2</sup>(equal to 100G).</li> <li>● Waveform: half sinusoidal wave, 6ms.</li> <li>● Number of shocks: one shock input in each direction of three mutually perpendicular axes for a total of three shock inputs.</li> </ul>
VIBRATION (NON-OPERATION)	<ul style="list-style-type: none"> <li>● Frequency range:8~33.3Hz</li> <li>● Stroke : 1.3 mm</li> <li>● Vibration: sinusoidal wave, perpendicular axis (both x,z axis: 2Hrs , and y axis: 4Hrs ).</li> <li>● Sweep: 2.9G,33.3 Hz -400 Hz</li> <li>● Cycle: 15 min</li> </ul>

### 9.3. ESD Test

ITEM	CONDITION	NOTE
ESD	150pF , 330Ω , ±8KV&±15KV air test	【Note1】
	200pF , 0Ω , ±200V contact test	【Note2】

[Note]

【Note1】 LCD glass and metal bezel

【Note2】 IF connector pins

### 9.4 Judgment Standard

The judgment of the above test should be made as follow:

Pass: Normal display image with no obvious non-uniformity and no line defect.  
Partial transformation of the module parts should be ignored.

Fail: No display image, obvious non-uniformity, or line defects.