

General Description

The MIC5248 is an efficient, precise CMOS voltage regulator with power good output. The MIC5248 offers better than 3% initial accuracy, and constant ground current (typically 100 μ A) over load.

The MIC5248 also works with low-ESR ceramic capacitors, reducing the amount of board space necessary for power applications, critical in handheld wireless devices.

Key features include current limit, thermal shutdown, a push-pull output for faster transient response, and an active clamp to speed up device turnoff. Available in the IttyBitty™ SOT-23-5 package, the MIC5248 is a fixed 1.2V regulator.

Features

- Power Good indicator
- Load independent, ultra-low ground current: 100 μ A
- 150mA output current
- Current limiting
- Thermal shutdown
- Tight load and line regulation
- “Zero” off-mode current
- Stability with low-ESR capacitors
- Fast transient response
- TTL-logic-controlled enable input

Applications

- Processor power-up sequencing
- Laptop, notebook, and palmtop computers
- PCMCIA V_{CC} and V_{PP} regulation/switching

Ordering Information

Part Number	Marking	Voltage	Junction Temp. Range*	Package
MIC5248-1.2BM5	LV12	1.2	-40°C to +125°C	SOT-23-5
MIC5248-1.2YM5	KV12	1.2	-40°C to +125°C, Lead-free	SOT-23-5

Other voltages available. Contact Micrel for details.

Typical Application

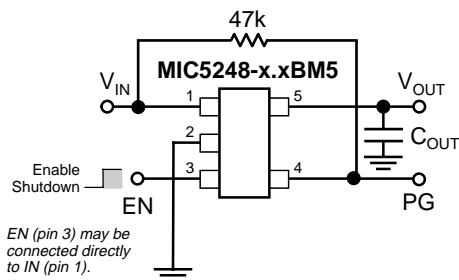

Low-Noise Regulator Application

Pin Configuration

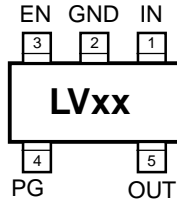

MIC5248-x.xBM5

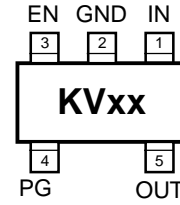

MIC5248-x.xYM5

Pin Description

Pin Number	Pin Name	Pin Function
1	IN	Supply Input
2	GND	Ground
3	EN	Enable/Shutdown (Input): CMOS compatible input. Logic high = enable; logic low = shutdown. Do not leave open.
4	PG	Power Good Output
5	OUT	Regulator Output

Absolute Maximum Ratings (Note 1)

Supply Input Voltage (V_{IN})	0V to +7V
Enable Input Voltage (V_{EN})	0V to V_{IN}
Flag Output Voltage (V_{PG})	0V to V_{IN}
Junction Temperature (T_J)	+150°C
Storage Temperature	-65°C to +150°C
Lead Temperature (soldering, 5 sec.)	260°C

ESD, Note 3**Operating Ratings (Note 2)**

Input Voltage (V_{IN})	+2.7V to +6V
Enable Input Voltage (V_{EN})	0V to V_{IN}
Flag Output Voltage (V_{PG})	0V to V_{IN}
Junction Temperature (T_J)	-40°C to +125°C
Thermal Resistance	
SOT-23(θ_{JA})	235°C/W

Electrical Characteristics

$V_{IN} = 2.7V$, $V_{EN} = V_{IN}$; $I_{OUT} = 100\mu A$; $T_J = 25^\circ C$, **bold** values indicate $-40^\circ C \leq T_J \leq +125^\circ C$; unless noted.

Symbol	Parameter	Conditions	Min	Typical	Max	Units
V_O	Output Voltage Accuracy	$I_{OUT} = 100\mu A$	-3		3	%
			-4		4	%
ΔV_{LNR}	Line Regulation	$V_{IN} = 2.7V$ to 6V	-0.3	0	0.3	%/V
ΔV_{LDR}	Load Regulation	$I_{OUT} = 0.1mA$ to 150mA, Note 4		4.0	5.0	%
I_Q	Quiescent Current	$V_{EN} \leq 0.4V$ (shutdown)		0.45	1	μA
I_{GND}	Ground Pin Current, Note 5	$I_{OUT} = 0mA$; $V_{IN} = 6.0V$		100	150	μA
		$I_{OUT} = 150mA$; $V_{IN} = 6.0V$		100	150	μA
PSRR	Power Supply Rejection	$f = 120Hz$, $C_{OUT} = 4.7\mu F$, $I_{OUT} = 150mA$		60		dB
I_{LIM}	Current Limit	$V_{OUT} = 0V$	160	350		mA

Enable Input

V_{IL}	Enable Input Logic-Low Voltage	$V_{IN} = 5.5V$, regulator shutdown			0.4	V
V_{IH}	Enable Input Logic-High Voltage	$V_{IN} = 5.5V$, regulator enabled	1.6			V
I_{EN}	Enable Input Current	$V_{IL} \leq 0.4V$; $V_{IN} = 5.5V$		0.01		μA
		$V_{IH} \geq 1.6V$; $V_{IN} = 5.5V$		0.01		μA

Thermal Protection

	Thermal Shutdown Temperature			150		°C
	Thermal Shutdown Hysteresis			10		°C

Power Good, Note 6

V_{PG}	Low Threshold	% of V_{OUT} (PG ON)	89.5			%
	High Threshold	% of V_{OUT} (PG OFF)			96.5	%
V_{OL}	PG Output Logic-Low Voltage	$I_L = 100\mu A$, fault condition		0.02	0.1	V
I_{PG}	Power Good Leakage Current	power good off, $V_{PG} = 5.5V$		0.01		μA
V_{PG} Delay	Delay Time to Power Good	See "Timing Diagram"	1		5	ms

Note 1. Exceeding the absolute maximum rating may damage the device.

Note 2. The device is not guaranteed to function outside its operating rating.

Note 3. Devices are ESD sensitive. Handling precautions recommended.

Note 4. Regulation is measured at constant junction temperature using low duty cycle pulse testing. Parts are tested for load regulation in the load range from 0.1mA to 150mA. Changes in output voltage due to heating effects are covered by the thermal regulation specification.

Note 5. Ground pin current is the regulator quiescent current. The total current drawn from the supply is the sum of the load current plus the ground pin current.

Note 6. The power good is a function of the output voltage being 5% low and the detection of one of the following: overcurrent, over-temperature or dropout. See "Applications Information" section for additional information.

Block Diagrams

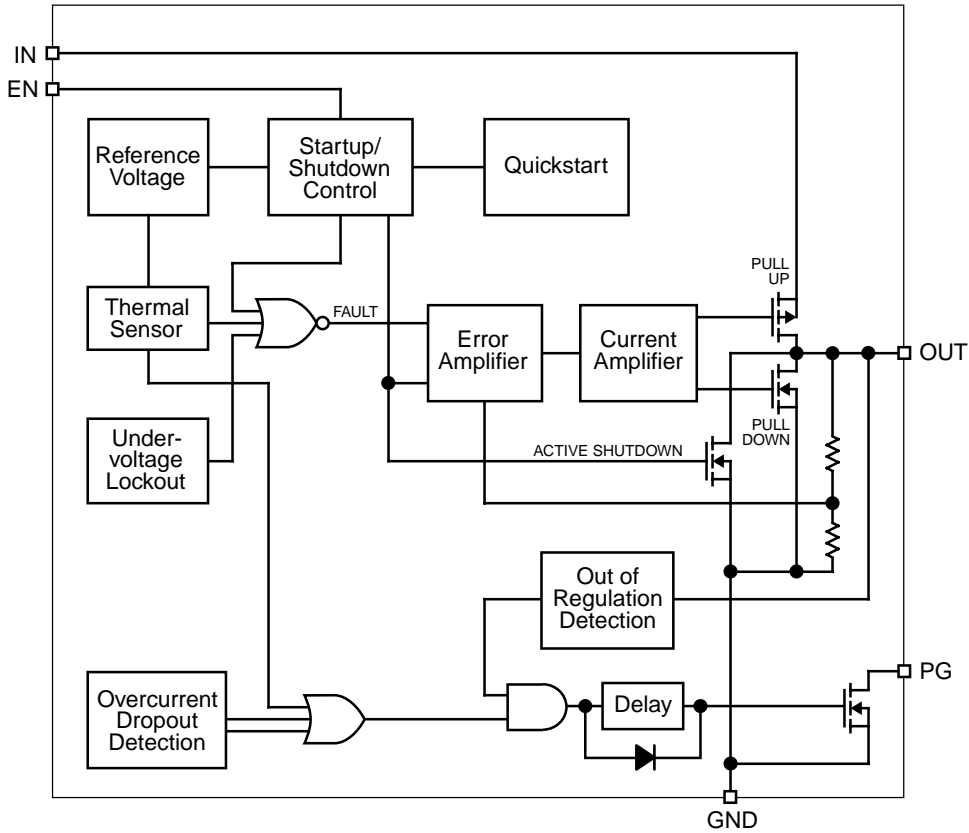

Timing Diagram

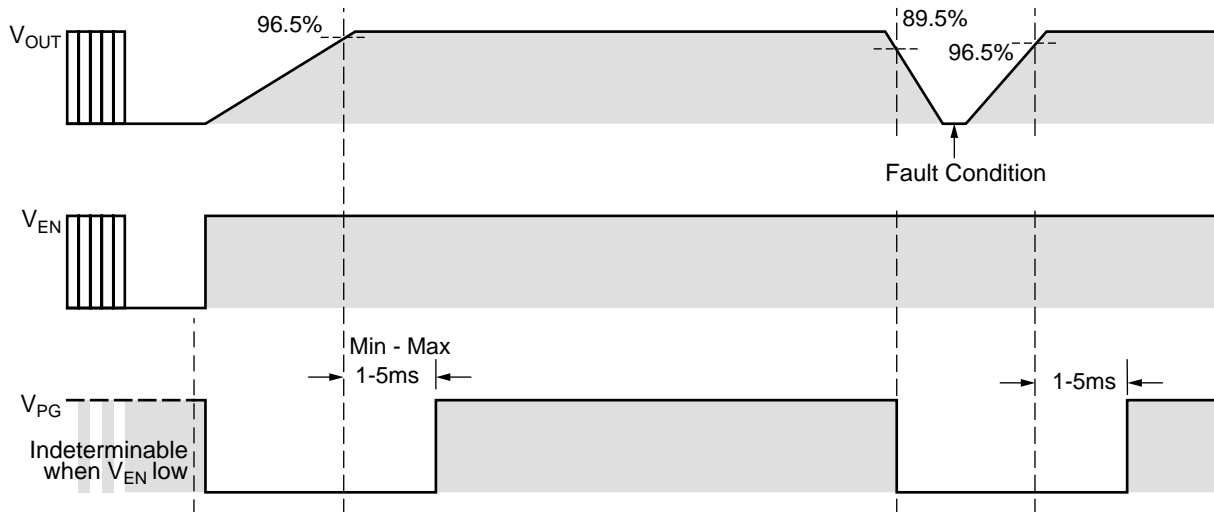

Typical Characteristics

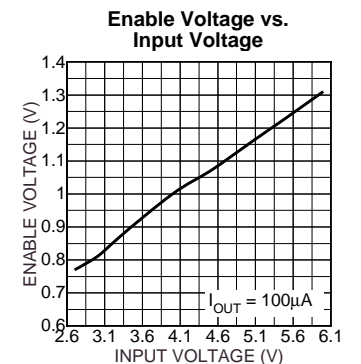
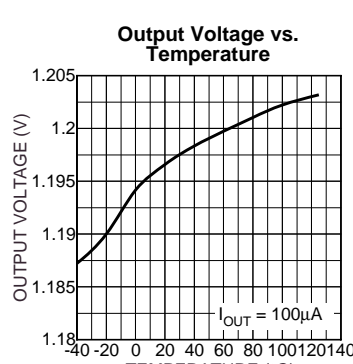
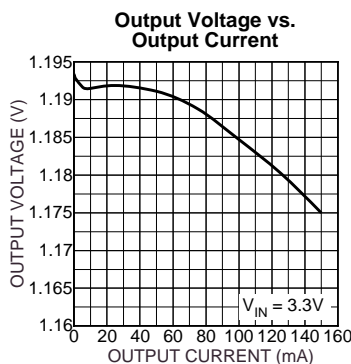
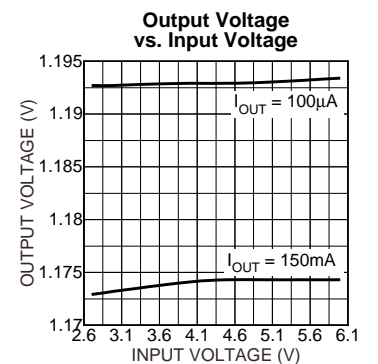
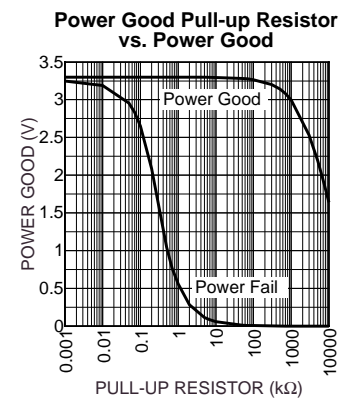
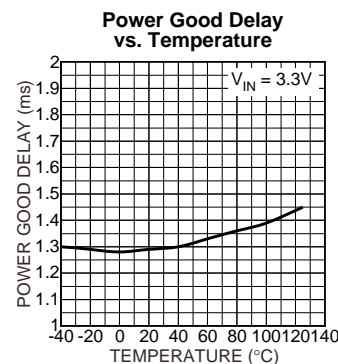
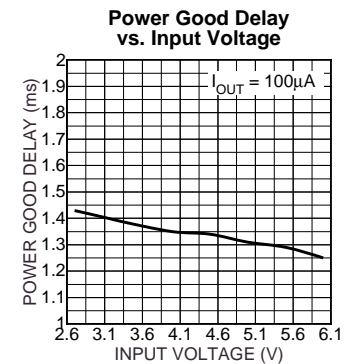
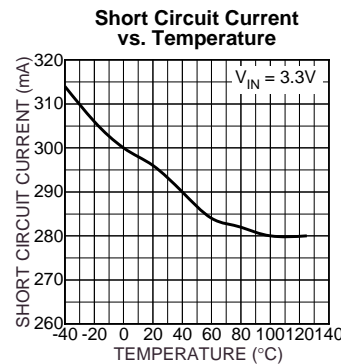
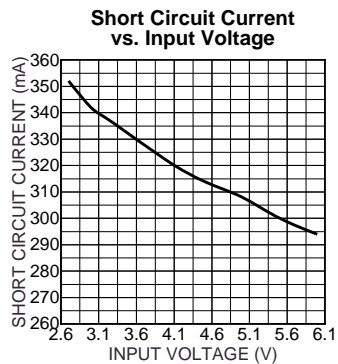
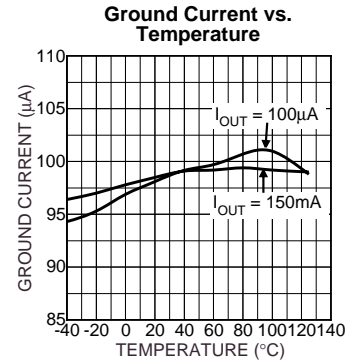
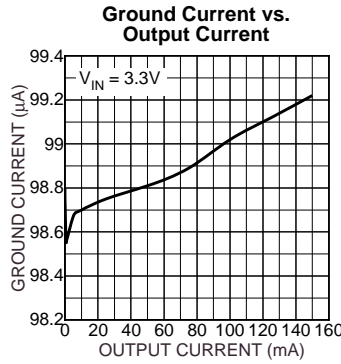
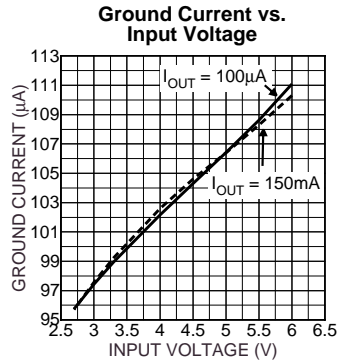

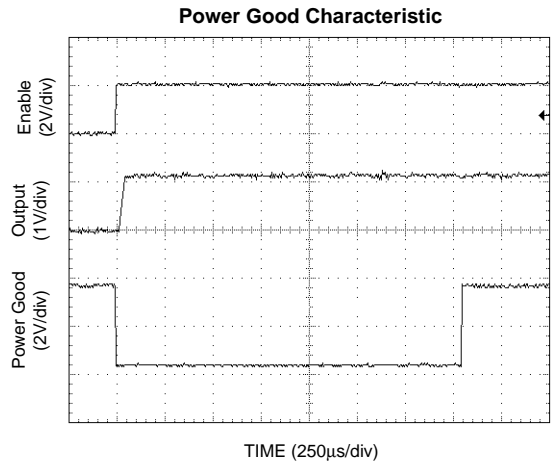
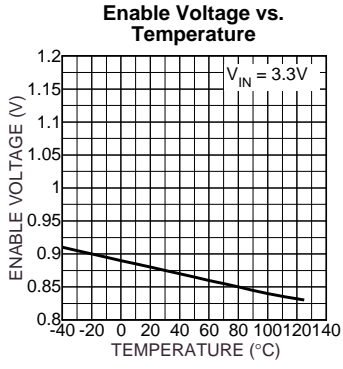

Applications Information

Enable/Shutdown

The MIC5248 comes with an active-high enable pin that allows the regulator to be disabled. Forcing the enable pin low disables the regulator and sends it into a “zero” off-mode-current state. In this state, current consumed by the regulator goes nearly to zero. Forcing the enable pin high enables the output voltage. This part is CMOS and the enable pin cannot be left floating; a floating enable pin may cause an indeterminate state on the output.

Input Capacitor

An input capacitor is not required for stability. A 1 μ F input capacitor is recommended when the bulk ac supply capacitance is more than 10 inches away from the device, or when the supply is a battery.

Output Capacitor

The MIC5248 requires an output capacitor for stability. The design requires 1 μ F or greater on the output to maintain stability. The capacitor can be a low-ESR ceramic chip capacitor. The MIC5248 has been designed to work specifically with the low-cost, small chip capacitors. Tantalum capacitors can also be used for improved capacitance over temperature. The value of the capacitor can be increased without bound.

X7R dielectric ceramic capacitors are recommended because of their temperature performance. X7R-type capacitors change capacitance by 15% over their operating temperature range and are the most stable type of ceramic capacitors. Z5U and Y5V dielectric capacitors change value by as much 50% and 60% respectively over their operating temperature ranges. To use a ceramic chip capacitor with Y5V dielectric, the value must be much higher than an X7R ceramic or a tantalum capacitor to ensure the same minimum capacitance value over the operating temperature range. Tantalum capacitors have a very stable dielectric (10% over their operating temperature range) and can also be used with this device.

Power Good

The Power Good output is an open-drain output. It is designed essentially to work as a power-on reset generator once the regulated voltage was up and/or a fault condition. The output of the Power Good drives low when a fault condition AND an undervoltage detection occurs. The Power Good output come back up once the output has reached 96.5% of its nominal value and a 1ms to 5ms delay has passed. See “Timing Diagram.”

The MIC5248’s internal circuit intelligently monitors overcurrent, over-temperature and dropout conditions and ORs these outputs together to indicate some fault condition. This output is fed into an on-board delay circuitry that drives the open drain transistor to indicate a fault.

Transient Response

The MIC5248 implements a unique output stage to dramatically improve transient response recovery time. The output is a totem-pole configuration with a P-channel MOSFET pass device and an N-channel MOSFET clamp. The N-channel clamp is a significantly smaller device that prevents the output voltage from overshooting when a heavy load is removed. This feature helps to speed up the transient response by significantly decreasing transient response recovery time during the transition from heavy load (100mA) to light load (100 μ A).

Active Shutdown

The MIC5248 also features an active shutdown clamp, which is an N-channel MOSFET that turns on when the device is disabled. This allows the output capacitor and load to discharge, de-energizing the load.

Thermal Considerations

The MIC5248 is designed to provide 150mA of continuous current in a very small package. Maximum power dissipation can be calculated based on the output current and the voltage drop across the part. To determine the maximum power dissipation of the package, use the junction-to-ambient thermal resistance of the device and the following basic equation:

$$P_{D(max)} = \left(\frac{T_{J(max)} - T_A}{\theta_{JA}} \right)$$

$T_{J(max)}$ is the maximum junction temperature of the die, 125°C, and T_A is the ambient operating temperature. θ_{JA} is layout dependent; Table 1 shows examples of junction-to-ambient thermal resistance for the MIC5248.

Package	θ_{JA} Recommended Minimum Footprint	θ_{JA} 1" Square Copper Clad	θ_{JC}
SOT-23-5 (M5)	235°C/W	185°C/W	145°C/W

Table 1. SOT-23-5 Thermal Resistance

The actual power dissipation of the regulator circuit can be determined using the equation:

$$P_D = (V_{IN} - V_{OUT}) I_{OUT} + V_{IN} I_{GND}$$

Substituting $P_{D(max)}$ for P_D and solving for the operating conditions that are critical to the application will give the maximum operating conditions for the regulator circuit. For example, when operating the MIC5248-1.2BM5 at 50°C with a minimum footprint layout, the maximum input voltage for a set output current can be determined as follows:

$$P_{D(max)} = \left(\frac{125^\circ\text{C} - 50^\circ\text{C}}{235^\circ\text{C/W}} \right)$$

$$P_{D(max)} = 315\text{mW}$$

The junction-to-ambient thermal resistance for the minimum footprint is 235°C/W, from Table 1. The maximum power dissipation must not be exceeded for proper operation. Using the output voltage of 1.2V and an output current of 150mA, the maximum input voltage can be determined. Because this device is CMOS and the ground current is typically 100 μ A over the load range, the power dissipation contributed by the

ground current is < 1% and can be ignored for this calculation.

$$315\text{mW} = (V_{\text{IN}} - 1.2\text{V}) 150\text{mA}$$

$$315\text{mW} = V_{\text{IN}} \times 150\text{mA} - 195\text{mW}$$

$$510\text{mW} = V_{\text{IN}} \times 150\text{mA}$$

$$V_{\text{IN(max)}} = 3.4\text{V}$$

Therefore, a 1.2V application at 150mA of output current can accept a maximum input voltage of 3.4V in a SOT-23-5 package. For a full discussion of heat sinking and thermal effects on voltage regulators, refer to the Regulator Thermals section of Micrel's *Designing with Low-Dropout Voltage Regulators* handbook.

Dual-Supply Operation

When used in dual supply systems where the regulator load is returned to a negative supply, the output voltage must be diode clamped to ground.

Package Information

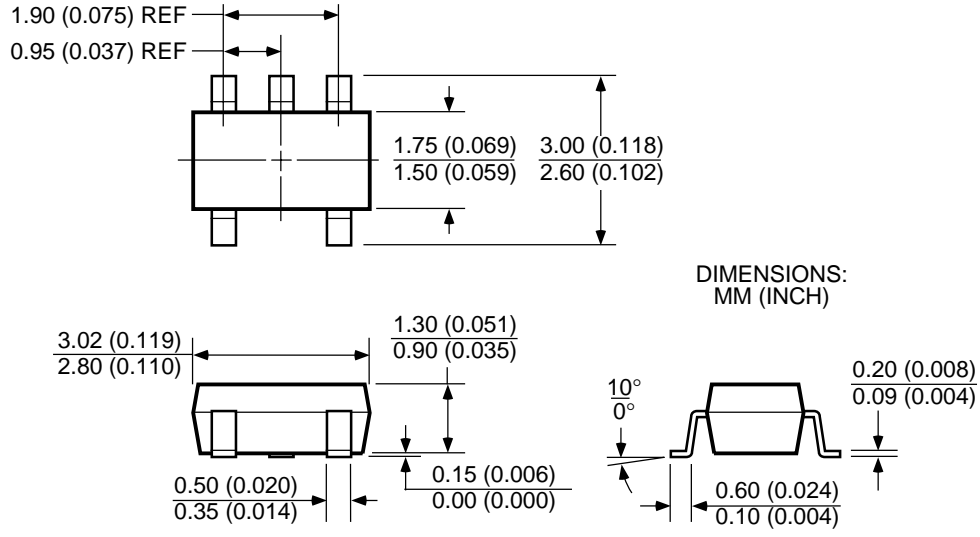

SOT-23-5 (M)

MICREL INC. 1849 FORTUNE DRIVE SAN JOSE, CA 95131 USA

TEL + 1 (408) 944-0800 FAX + 1 (408) 944-0970 WEB <http://www.micrel.com>

This information is believed to be accurate and reliable, however no responsibility is assumed by Micrel for its use nor for any infringement of patents or other rights of third parties resulting from its use. No license is granted by implication or otherwise under any patent or patent right of Micrel Inc.

© 2001 Micrel Incorporated