

# Multi TOPLED mit LED und Fototransistor-Detektor Multi TOPLED with LED and Phototransistor-Detector

SFH 7225  
SFH 7226



## Wesentliche Merkmale

- Anzeigefunktion kann durch eingebauten Fototransistor überwacht werden
- SFH 7225: gelbe LED
- SFH 7226: super-rote LED
- Dominantwellenlänge:  
SFH 7225: 589 nm  
SFH 7226: 630 nm
- Silizium-Fototransistor
- Geringe Sättigungsspannung
- Emitter und Diode galvanisch getrennt

## Anwendungen

- Anzeige mit Funktionskontrolle

## Features

- Display function can be controlled by built-in phototransistor
- SFH 7225: yellow LED
- SFH 7226: super-red LED
- Dominant wavelength:  
SFH 7225: 589 nm  
SFH 7226: 630 nm
- Silicon phototransistor
- Low saturation voltage
- Emitter and detector electrically isolated

## Applications

- Display with controlling function

Typ Type	Gehäuse Package	Lichtstärke Luminous Intensity $I_F = 20 \text{ mA}, t_p = 20 \text{ mA}$ $I_V$ (mcd)	Bestellnummer Ordering Code
SFH 7225-Q/R	SMT Multi TOPLED	63 ... 200	Q62702-P5319
SFH 7226-P/Q	SMT Multi TOPLED	40 ... 125	Q62702-P5320

**Grenzwerte**  
**Maximum Ratings**

Bezeichnung Parameter	Symbol Symbol	Wert Value	Einheit Unit
Betriebstemperatur Operating temperature range	$T_{op}$	- 40 ... + 100	°C
Lagertemperatur Storage temperature range	$T_{stg}$	- 40 ... + 100	°C

**Sender**  
**Emitter**

Sperrspannung Reverse voltage	$V_R$	3	V
Durchlassstrom Forward current	$I_F$ (DC)	20	mA
Verlustleistung Total power dissipation	$P_{tot}$	80	mW
Wärmewiderstand Thermal resistance			
Sperrschicht/Umgebung Junction/ambient	$R_{th JA}$	800 600 <sup>1)</sup>	K/W K/W
Sperrschicht/Lötpad Junction/solder point	$R_{th JS}$	500 340 <sup>1)</sup>	K/W K/W
Montage auf PC-Board FR4 Mounted on PC board FR4			

**Empfänger (Si-Fototransistor)**  
**Detector (Silicon phototransistor)**

Kollektor-Emitterspannung Collector-emitter voltage	$V_{CE}$	35	V
Kollektorstrom Collector current	$I_C$	15	mA
Kollektorspitzenstrom, $t_p < 10 \mu s$ Collector surge current	$I_{CS}$	75	mA
Verlustleistung Total power dissipation	$P_{tot}$	90	mW

<sup>1)</sup> This value is valid only when the power dissipation of the photo transistor is limited to max. 2.5 mW.

Kennwerte ( $T_A = 25\text{ °C}$ )

## Characteristics

Bezeichnung Description	Symbol Symbol	Wert Value		Einheit Unit
		SFH 7225	SFH 7226	

## Sender

## Emitter

Wellenlänge der Strahlung, $I_F = 20\text{ mA}$ Wavelength of peak emission	$\lambda_{\text{peak}}$	591	645	nm
Dominantwellenlänge, $I_F = 20\text{ mA}$ Dominant wavelength	$\lambda_{\text{peak}}$	589	630	nm
Spektrale Bandbreite, $I_F = 20\text{ mA}$ Spectral radiation bandwidth	$\Delta\lambda$	15	16	nm
Abstrahlwinkel Half angle	$\Phi$	$\pm 60$	$\pm 60$	Grad Deg.
Durchlassspannung Forward voltage $I_F = 20\text{ mA}$ , $t_p = 20\text{ ms}$	$V_F$	2.0 ( $\leq 2.6$ )	2.0 ( $\leq 2.6$ )	V
Sperrstrom, $V_R = 3\text{ V}$ Reverse current	$I_R$	0.01 ( $< 10$ )	0.01 ( $< 10$ )	$\mu\text{A}$
Temperaturkoeffizient von $\lambda_{\text{dom}}$ Temperature coefficient of $\lambda_{\text{dom}}$ $I_F = 20\text{ mA}$	$TC_{\lambda_{\text{dom}}}$	0.096	0.014	nm/K
Temperaturkoeffizient von $\lambda_{\text{peak}}$ Temperature coefficient of $\lambda_{\text{peak}}$ $I_F = 20\text{ mA}$	$TC_{\lambda_{\text{peak}}}$	0.13	0.14	nm/K
Temperaturkoeffizient von $V_F$ Temperature coefficient of $V_F$ $I_F = 20\text{ mA}$	$TC_{V_F}$	- 2.5	- 2.0	mV/K

## Empfänger

## Detector

Wellenlänge der max. Fotoempfindlichkeit Wavelength of max. sensitivity	$\lambda_{S\text{ max}}$	860	nm
Spektraler Bereich der Fotoempfindlichkeit $S = 10\%$ von $S_{\text{max}}$ Spectral range of sensitivity $S = 10\%$ von $S_{\text{max}}$	$\lambda$	380 ... 1150	nm

Kennwerte ( $T_A = 25\text{ °C}$ )

Characteristics (cont'd)

Bezeichnung Description	Symbol Symbol	Wert Value		Einheit Unit
		SFH 7225	SFH 7226	
Dunkelstrom, $V_{CE} = 25\text{ V}$ Dark current	$I_{CEO}$	1 (< 200)		nA
Kapazität, $V_{CE} = 0\text{ V}$ , $f = 1\text{ MHz}$ , $E = 0$ Capacitance	$C_{CE}$	5		pF
Fremdlichtempfindlichkeit Sensitivity to ambient light $E_V = 1000\text{ lx}$ , Normlicht A/standard light A, $V_{CE} = 5\text{ V}$	$I_{CEtyp}$	650		$\mu\text{A}$

**MULTILED**

Übersprechen: Kollektor-Emitterstrom Crosstalk: collector-emitter current $I_F = 20\text{ mA}$ , $V_{CE} = 5\text{ V}$	$I_{CEtyp}$	0.5 ... 5	2 ... 15	mA
Kollektor-Emitter-Sättigungsspannung Collector-emitter saturation voltage $I_F = 20\text{ mA}$ , $I_C = 0.3 \times I_{CEmin}$	$V_{CEsat}$	< 0.4		V

**Relative Spectral Emission**  $I_{rel} = f(\lambda)$ ,  $T_A = 25\text{ }^\circ\text{C}$ ,  $I_F = 20\text{ mA}$   
 $V(\lambda)$  = Standard Eye Response Curve

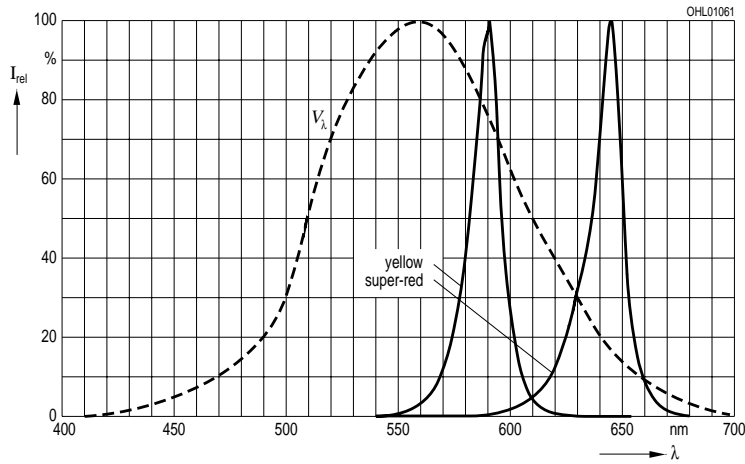

**LED Radiation Characteristics**  $I_{rel} = f(\varphi)$   
**Photodiode Directional Characteristics**  $S_{rel} = f(\varphi)$

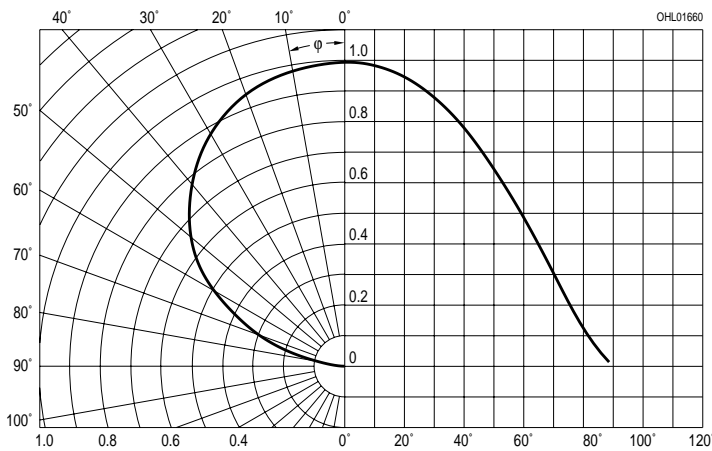

**LED**

**Forward Current**  
 $I_F = f(V_F), T_A = 25^\circ\text{C}$

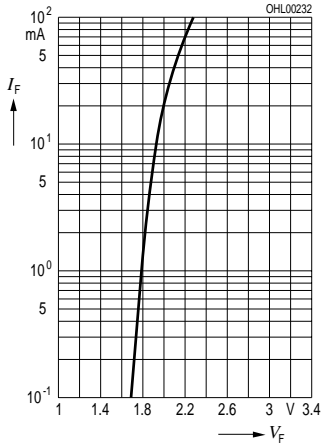

**Perm. Pulse Handling Capability**  
 $I_F = f(t_p), \text{duty cycle } D = \text{parameter}, T_A = 25^\circ\text{C}, \text{SFH 7225}$

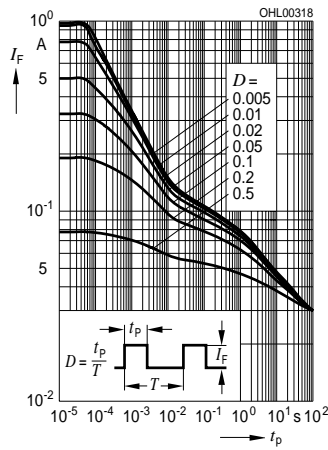

**Perm. Pulse Handling Capability**  
 $I_F = f(t_p), \text{duty cycle } D = \text{parameter}, T_A = 25^\circ\text{C}, \text{SFH 7226}$

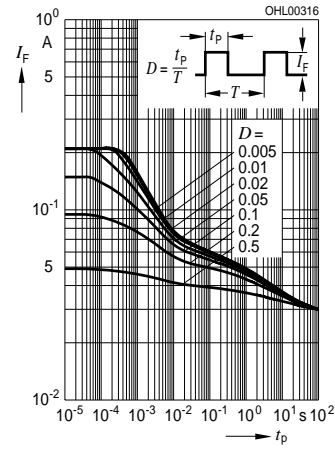

**Max. Permissible Forward Current**  
 $I_F = f(T_A)$

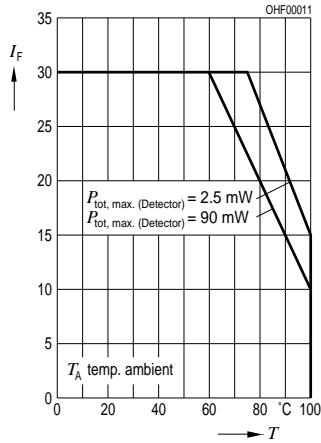

**Relative Luminous Intensity**  
 $I_V/I_V(10 \text{ mA}) = f(I_F), T_A = 25^\circ\text{C}$

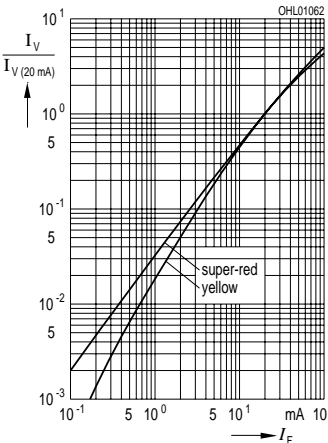

**Rel. Luminous Intensity**  
 $I_V/I_V(25^\circ\text{C}) = f(T_A), I_F = 10 \text{ mA}$

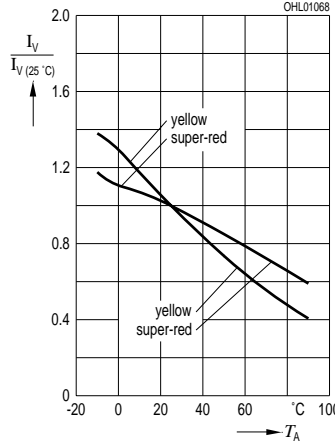

**Max. Permissible Forward Current**  
 $I_F = f(T_S)$

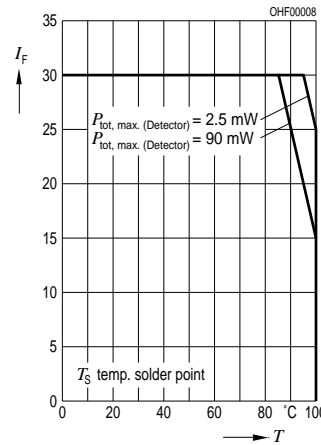

**Phototransistor**

**Rel. spectral sensitivity**

$S_{rel} = f(\lambda)$

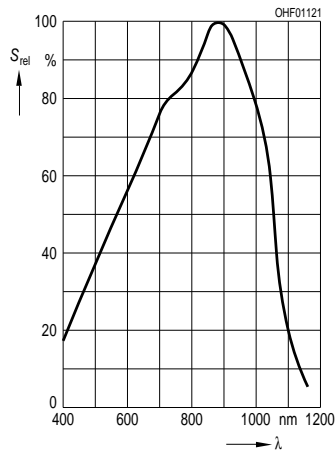

**Photocurrent**

$I_{PCE} = f(V_{CE}), E_e = \text{Parameter}$

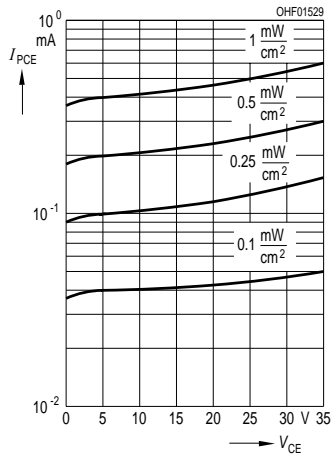

**Dark current**

$I_{CEO} = f(V_{CE}), E = 0$

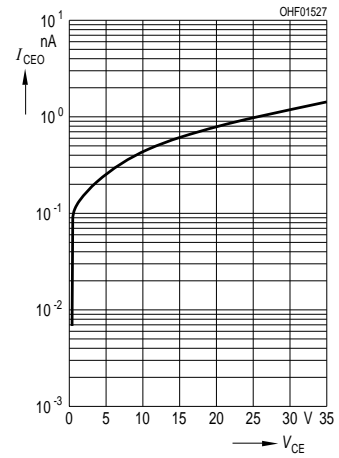

**Dark current**

$I_{CEO} = f(T_A), V_{CE} = 5 \text{ V}, E = 0$

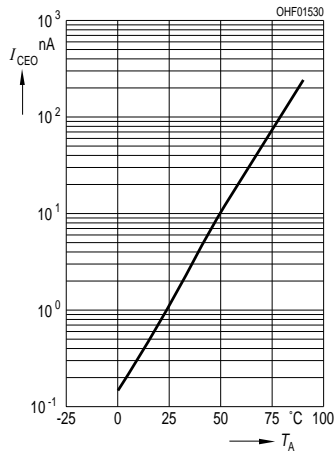

**Capacitance**

$C_{CE} = f(V_{CE}), f = 1 \text{ MHz}, E = 0$

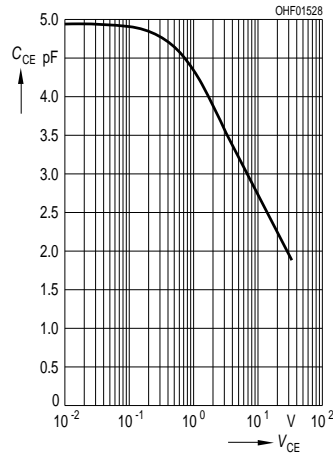

**Photocurrent**

$I_{PCE}/I_{PCE25^\circ} = f(T_A), V_{CE} = 5 \text{ V}$

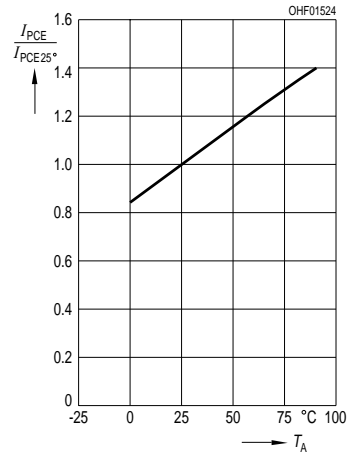

## Maßzeichnung Package Outlines

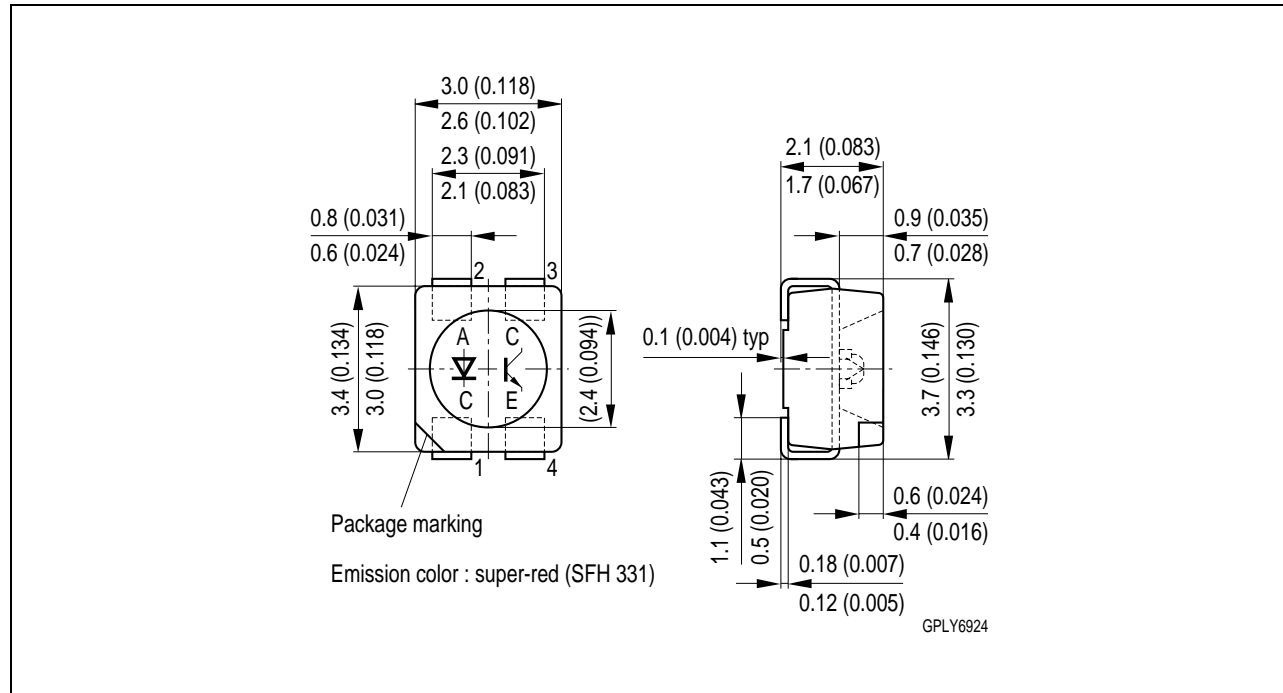

Maße werden wie folgt angegeben: mm (inch) / Dimensions are specified as follows: mm (inch).

Published by OSRAM Opto Semiconductors GmbH & Co. OHG  
Wernerwerkstrasse 2, D-93049 Regensburg

© All Rights Reserved.

### Attention please!

The information describes the type of component and shall not be considered as assured characteristics. Terms of delivery and rights to change design reserved. Due to technical requirements components may contain dangerous substances. For information on the types in question please contact our Sales Organization.

### Packing

Please use the recycling operators known to you. We can also help you – get in touch with your nearest sales office. By agreement we will take packing material back, if it is sorted. You must bear the costs of transport. For packing material that is returned to us unsorted or which we are not obliged to accept, we shall have to invoice you for any costs incurred.

**Components used in life-support devices or systems must be expressly authorized for such purpose!** Critical components <sup>1</sup>, may only be used in life-support devices or systems <sup>2</sup> with the express written approval of OSRAM OS.

<sup>1</sup> A critical component is a component used in a life-support device or system whose failure can reasonably be expected to cause the failure of that life-support device or system, or to affect its safety or effectiveness of that device or system.

<sup>2</sup> Life support devices or systems are intended (a) to be implanted in the human body, or (b) to support and/or maintain and sustain human life. If they fail, it is reasonable to assume that the health of the user may be endangered.