

FEATURES

Fully Differential Signal Path

May also be Used with Single-Sided Signals

Inputs from 0.3 mV to 1 V rms, Rail-Rail Outputs

Differential $R_{IN} = 1 \text{ k}\Omega$; R_{OUT} (Each Output) 75Ω

Automatic Offset Compensation (Optional)

Linear-in-dB and Linear-in-Magnitude Gain Modes

0 dB to 50 dB, for $0 \text{ V} < V_{DBS} < 1.5 \text{ V}$ (30 mV/dB)

Inverted Gain Mode: 50 dB to 0 dB at -30 mV/dB

$\times 0.03$ to $\times 10$ Nominal Gain for $15 \text{ mV} < V_{MAG} < 5 \text{ V}$

Constant Bandwidth: 150 MHz at All Gains

Low Noise: 5 nV/ $\sqrt{\text{Hz}}$ typical at Maximum Gain

Low Distortion: $\leq -62 \text{ dBc}$ Typ

Low Power: 20 mA Typ at V_S of 2.7 V – 6 V

Available in Space Saving 3×3 LFCSP Package

APPLICATIONS

Pre-ADC Signal Conditioning

75 Ω Cable Driving Adjust

AGC Amplifiers

GENERAL DESCRIPTION

The AD8330 is a wideband variable-gain amplifier for use in applications requiring a fully differential signal path, low noise, well-defined gain, and moderately low distortion, from dc to 150 MHz. The input pins can also be driven from a single ended source. The peak differential input is $\pm 2 \text{ V}$, allowing sinewave operation at 1 V rms with generous headroom. The output pins can optionally drive single-sided loads and each swing essentially rail-to-rail. The differential output resistance is 150Ω . The output swing is a linear function of the voltage applied to the VMAG pin, which internally defaults to 0.5 V, to provide a peak output of $\pm 2 \text{ V}$. This may be raised to 10 V p-p, limited by the supply voltage.

The basic gain function is linear-in-dB, controlled by the voltage applied to pin VDBS. The gain ranges from 0 dB to 50 dB for control voltages between 0 V and 1.5 V—a slope of 30 mV/dB. The gain linearity is typically within $\pm 0.1 \text{ dB}$. By changing the logic level on pin MODE, the gain will decrease over the same range, with opposite slope. A second gain control port is provided at pin VMAG and allows the user to vary the numeric gain from a factor of 0.03 to 10. All the parameters of the AD8330 have low sensitivities to temperature and supply voltages.

Using V_{MAG} , the basic 0 dB to 50 dB range can be repositioned to any value from 20 dB higher (that is, 20 dB to 70 dB) to at least 30 dB lower (that is, -30 dB to $+20 \text{ dB}$) to suit the application, providing an unprecedented gain range of over 100 dB. A unique aspect of the AD8330 is that its bandwidth and pulse response are essentially constant for all gains, not only over the basic 50 dB linear-in-dB

*Protected by U.S. Patent No. 5,969,657; other patents pending.

REV. A

Information furnished by Analog Devices is believed to be accurate and reliable. However, no responsibility is assumed by Analog Devices for its use, nor for any infringements of patents or other rights of third parties that may result from its use. No license is granted by implication or otherwise under any patent or patent rights of Analog Devices. Trademarks and registered trademarks are the property of their respective companies.

FUNCTIONAL BLOCK DIAGRAM

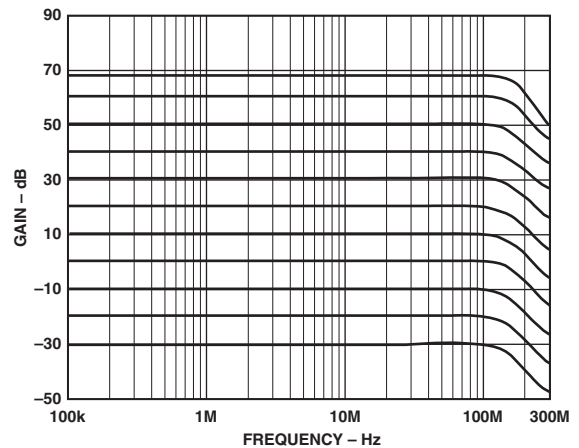
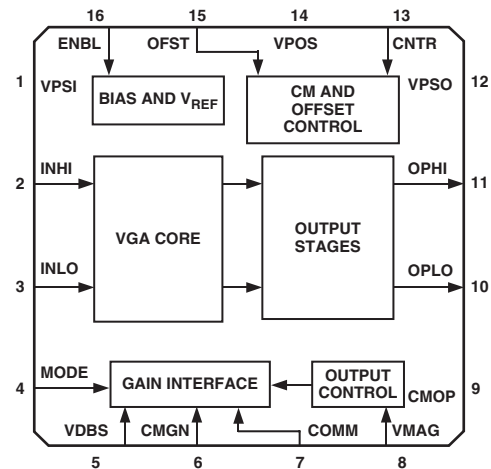

Figure 1. AC Response over the Extended Gain Range

range, but also when using the linear-in-magnitude function. The exceptional stability of the HF response over the gain range is of particular value in those VGA applications where it is essential to maintain accurate gain law-conformance at high frequencies.

An external capacitor at pin OFST sets the high-pass corner of an offset reduction loop, whose frequency may be as low as 5 Hz. When this pin is grounded, the signal path becomes dc-coupled. When used to drive an ADC, an external common-mode control voltage at pin CNTR can be driven to within 0.5 V of either ground or V_S to accommodate a wide variety of requirements. By default, the two outputs are positioned at the mid point of the supply, $V_S/2$. Other features, such as two levels of power-down (fully off and a hibernate mode), further extend the practical value of this exceptionally versatile VGA.

The AD8330 is available in a 16-lead LFCSP and 16-lead QSOP packages and is specified for operation from -40°C to $+85^\circ\text{C}$.

AD8330—SPECIFICATIONS ($V_S = 5\text{ V}$, $T_A = 25^\circ\text{C}$, $C_L = 12\text{ pF}$ on OPHI and OPLO, $R_L = \text{O/C}$, $V_{\text{DBS}} = 0.75\text{ V}$, $V_{\text{MODE}} = \text{HI}$, $V_{\text{MAG}} = \text{O/C}$, $V_{\text{OFST}} = 0\text{ V}$, Differential Operation, unless otherwise noted.)

Parameter	Conditions	Min	Typ	Max	Unit
INPUT INTERFACE					
Full-Scale Input	Pins INHI, INLO $V_{\text{DBS}} = 0\text{ V}$, Differential Drive	± 1.4	± 2		V
Input Resistance	$V_{\text{DBS}} = 1.5\text{ V}$ Pin-to-Pin	± 4.5	± 6.3		mV
Input Capacitance	Either Pin to COMM	800	1K	1.2K	Ω
Voltage Noise Spectral Density	$f = 1\text{ MHz}$, $V_{\text{DBS}} = 1.5\text{ V}$; Inputs AC-shorted		4		pF
Common-Mode Voltage Level			5		$\text{nV}/\sqrt{\text{Hz}}$
Input Offset	Pin OFST Connected to COMM		3.0		V
Drift			1		mV rms
Permissible CM Range ¹		0	2	V_S	$\mu\text{V}/^\circ\text{C}$
Common-Mode AC Rejection	$f = 1\text{ MHz}$, 0.1 V rms $f = 50\text{ MHz}$		-60		V
			-55		dB
					dB
OUTPUT INTERFACE					
Small Signal -3dB Bandwidth	Pins OPHI, OPLO $0\text{ V} < V_{\text{DBS}} < 1.5\text{ V}$		150		MHz
Peak Slew Rate	$V_{\text{DBS}} = 0$		1500		$\text{V}/\mu\text{s}$
Peak-to-Peak Output Swing		± 1.8	± 2	± 2.2	V
Common-Mode Voltage	$V_{\text{MAG}} \geq 2\text{ V}$ (Peaks are Supply Limited)	± 4	± 4.5		V
Voltage Noise Spectral Density	Pin CNTR O/C $f = 1\text{ MHz}$, $V_{\text{DBS}} = 0$	2.4	2.5	2.6	V
Differential Output Impedance	Pin-to-Pin	120	150	180	$\text{nV}/\sqrt{\text{Hz}}$
HD2 ²	$V_{\text{OUT}} = 1\text{ V p-p}$, $f = 10\text{ MHz}$, $R_L = 1\text{ k}\Omega$		-62		Ω
HD3 ²	$V_{\text{OUT}} = 1\text{ V p-p}$, $f = 10\text{ MHz}$, $R_L = 1\text{ k}\Omega$		-53		dBc
					dBc
OUTPUT OFFSET CONTROL					
AC-Coupled Offset	Pin OFST C_{HPF} on Pin OFST ($0\text{ V} < V_{\text{DBS}} < 1.5\text{ V}$)		10		mV rms
High-Pass Corner Frequency	$C_{\text{HPF}} = 3.3\text{ nF}$, from OFST to CNTR (Scales as $1/C_{\text{HPF}}$)		100		kHz
COMMON-MODE CONTROL					
Usable Voltage Range	Pin CNTR	0.5		4.5	V
Input Resistance	From Pin CNTR to $V_S/2$		4		$\text{k}\Omega$
DECIBEL GAIN CONTROL					
Normal Voltage Range	Pins VDBS, CMGN, MODE CMGN Connected to COMM		0 to 1.5		V
Elevated Range	CMGN O/C (V_{CMGN} Rises to 0.2 V)		0.2 to 1.7		V
Gain Scaling	Mode HIGH or LOW	27	30	33	mV/dB
Gain Linearity Error	$0.3\text{ V} \leq V_{\text{DBS}} \leq 1.2\text{ V}$	-0.35	± 0.1	+0.35	dB
Absolute Gain Error	$V_{\text{DBS}} = 0$	-2	± 0.5	+2	dB
Bias Current	Flows out of pin VDBS		100		nA
Incremental Resistance			100		$\text{M}\Omega$
Gain Settling Time to 0.5 dB error	V_{DBS} Stepped from 0.05 V-1.45 V or 1.45 V-0.05 V		250		ns
Mode Up/Down	Pin MODE				
Mode Up Logic Level	Gain Increases with V_{DBS} , MODE = O/C	1.5			V
Mode Down Logic Level	Gain Decreases with V_{DBS}			0.5	V
LINEAR GAIN INTERFACE					
Peak Output Scaling, Gain vs. V_{MAG}	Pins VMAG, CMGN See Circuit Description Section	3.8	4.0	4.2	V/V
Gain Multiplication Factor vs. V_{MAG}	Gain is Nominal when $V_{\text{MAG}} = 0.5\text{ V}$		$\times 2$		
Usable Input Range		0		5	V
Default Voltage	V_{MAG} O/C	0.48	0.5	0.52	V
Incremental Resistance			4		$\text{k}\Omega$
Bandwidth	For $V_{\text{MAG}} \geq 0.1\text{ V}$		150		MHz

Parameter	Conditions	Min	Typ	Max	Unit
CHIP ENABLE	Pin ENBL				
Logic Voltage for Full Shutdown				0.5	V
Logic Voltage for Hibernate Mode	Output Pins Remain at CNTR	1.3	1.5	1.7	V
Logic Voltage for Full Operation		2.3			V
Current in Full Shutdown			20	100	μ A
Current in Hibernate Mode			1.5		mA
Minimum Time Delay ³			1.7		μ s
POWER SUPPLY	Pins VPSI, VPOS, VPSO, COMM, CMOP				
Supply Voltage		2.7		6	V
Quiescent Current	$V_{DBS} = 0.75$ V		20	27	mA

NOTES

¹The use of an input common-mode voltage significantly different than the internally set value is not recommended due to its effect on noise performance.

See Figure 13.

²See Typical Performance Characteristics for more detailed information on distortion in a variety of operating conditions.

³For minimum sized coupling capacitors.

AD8330

ABSOLUTE MAXIMUM RATINGS¹

Supply Voltage	6 V
Power Dissipation	
RQ Package ²	0.62 W
CP Package	1.67 W
Input Voltage at Any Pin	$V_S + 200 \text{ mV}$
Storage Temperature	-65°C to +105°C

Operating Temperature Range	-40°C to +85°C
Lead Temperature (Soldering 60 sec)	300°C

NOTES

¹Stresses above those listed under Absolute Maximum Ratings may cause permanent damage to the device. This is a stress rating only and functional operation of the device at these or any other conditions above those indicated in the operational section of this specification is not implied. Exposure to absolute maximum rating conditions for extended periods may affect device reliability.

²Four-Layer JEDEC Board (252P).

ORDERING GUIDE

Model	Temperature Range	Package Description	Package Outline
AD8330ACP	-40°C to +85°C	Chip Scale Package	LFCSP
AD8330ACP-REEL	-40°C to +85°C	Chip Scale Package	LFCSP
AD8330ACP-REEL7	-40°C to +85°C	Chip Scale Package	LFCSP
AD8330ARQ	-40°C to +85°C	Thin Shrink SO	QSOP
AD8330ARQ-REEL	-40°C to +85°C	Thin Shrink SO	QSOP
AD8330ARQ-REEL7	-40°C to +85°C	Thin Shrink SO	QSOP

CAUTION

ESD (electrostatic discharge) sensitive device. Electrostatic charges as high as 4000 V readily accumulate on the human body and test equipment and can discharge without detection. Although the AD8330 features proprietary ESD protection circuitry, permanent damage may occur on devices subjected to high energy electrostatic discharges. Therefore, proper ESD precautions are recommended to avoid performance degradation or loss of functionality.



PIN CONFIGURATIONS



PIN FUNCTION DESCRIPTIONS

16-Lead LFCSP			16-Lead QSOP		
Pin No.	Mnemonic	Description	Pin No.	Mnemonic	Description
1	VPSI	Positive Supply for Input Stages	1	OFST	Used in Offset Control Modes
2	INHI	Differential Signal Input, Positive Polarity	2	ENBL	Power Enable, Active High
3	INLO	Differential Signal Input, Negative Polarity	3	VPSI	Positive Supply for Input Stages
4	MODE	Logic Input: Selects Gain Slope. High = Gain Up versus V_{DBS}	4	INHI	Differential Signal Input, Positive Polarity
5	VDBS	Input for Linear-in-dB Gain Control Voltage, V_{DBS}	5	INLO	Differential Signal Input, Negative Polarity
6	CMGN	Common Baseline for Gain Control Interfaces	6	MODE	Logic Input: Selects Gain Slope. High = Gain Up versus V_{DBS}
7	COMM	Ground for Input and Gain Control Bias Circuitry	7	VDBS	Input for Linear-in-dB Gain Control Voltage, V_{DBS}
8	VMAG	Input for Gain/Amplitude Control, V_{MAG}	8	CMGN	Common Baseline for Gain Control Interfaces
9	CMOP	Ground for Output Stages	9	COMM	Ground for Input and Gain Control Bias Circuitry
10	OPLO	Differential Signal Output, Negative Polarity	10	VMAG	Input for Gain/Amplitude Control, V_{MAG}
11	OPHI	Differential Signal Output, Positive Polarity	11	CMOP	Ground for Output Stages
12	VPSO	Positive Supply for Output Stages	12	OPLO	Differential Signal Output, Negative Polarity
13	CNTR	Common-Mode Output Voltage Control	13	OPHI	Differential Signal Output, Positive Polarity
14	VPOS	Positive Supply for Inner Stages	14	VPSO	Positive Supply for Output Stages
15	OFST	Used in Offset Control Modes	15	CNTR	Common-Mode Output Voltage Control
16	ENBL	Power Enable, Active High	16	VPOS	Positive Supply for Inner Stages

AD8330—Typical Performance Characteristics

$V_S = 5\text{ V}$, $T_A = 25^\circ\text{C}$, $C_L = 12\text{ pF}$, $V_{DBS} = 0.75\text{ V}$, $V_{MODE} = \text{High (or O/C)}$, $V_{MAG} = \text{O/C}$, $R_L = \text{O/C}$, $V_{OFST} = 0$, Differential Operation, unless otherwise stated.

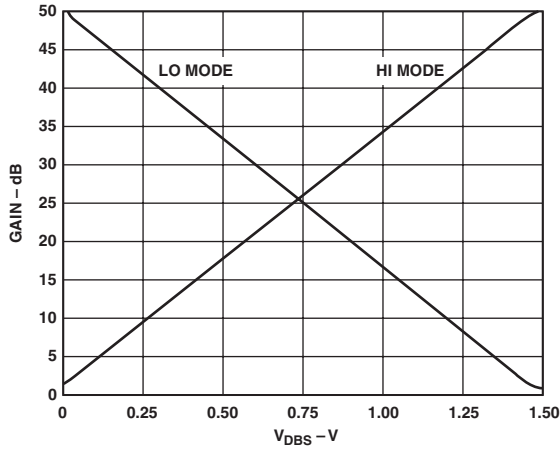

TPC 1. Gain vs. V_{DBS}

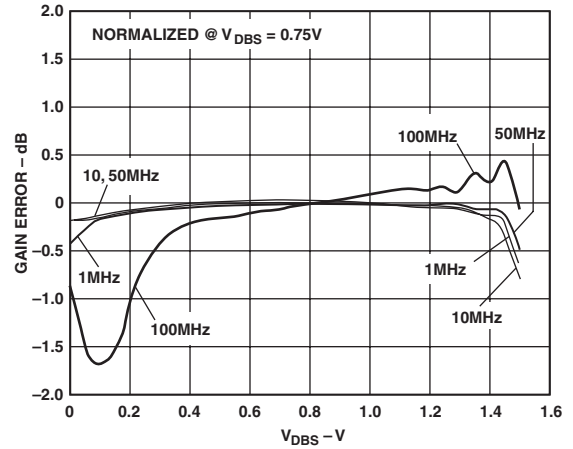

TPC 4. Gain Error vs. V_{DBS} at Various Frequencies

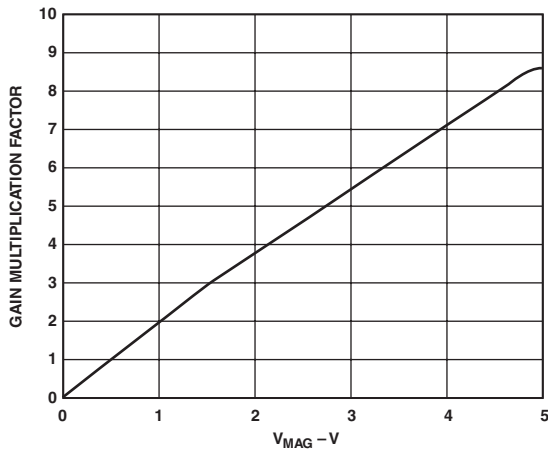

TPC 2. Linear Gain Multiplication Factor vs. V_{MAG}

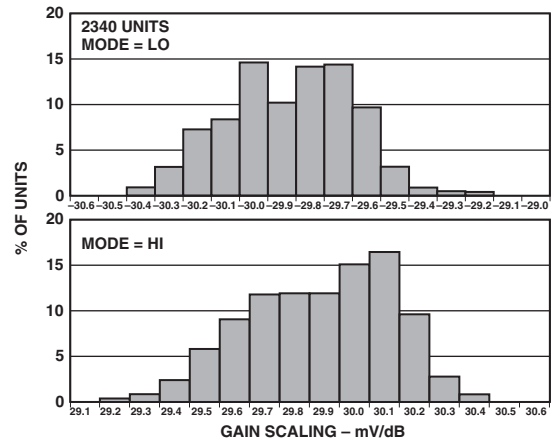

TPC 5. Gain Slope Histogram

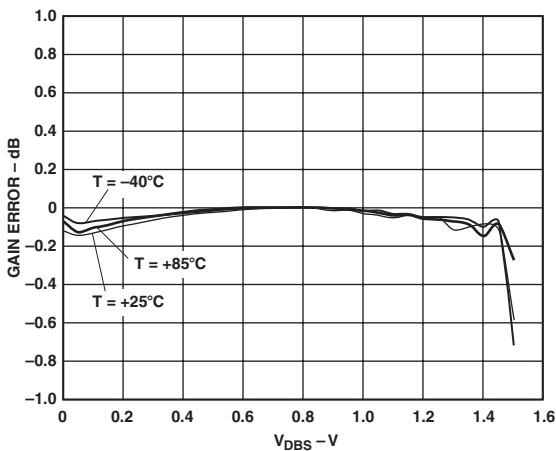

TPC 3. Gain Linearity Error Normalized at 25°C vs. V_{DBS} , at Three Temperatures, $f = 1\text{ MHz}$

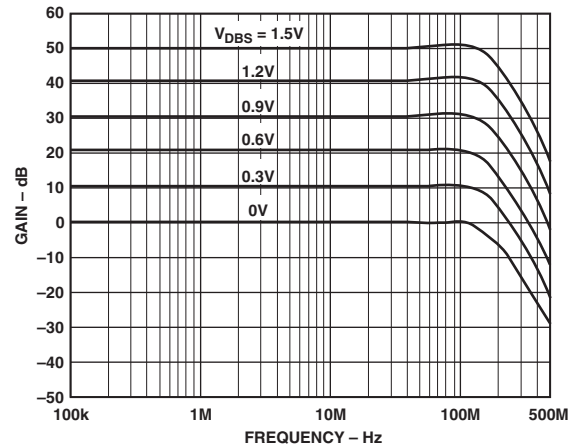

TPC 6. Frequency Response in 10 dB Steps for Various Values of V_{DBS}

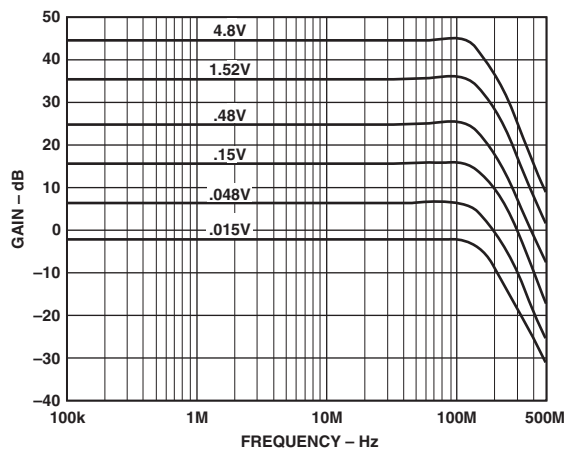

TPC 7. Frequency Response for Various Values of V_{MAG}

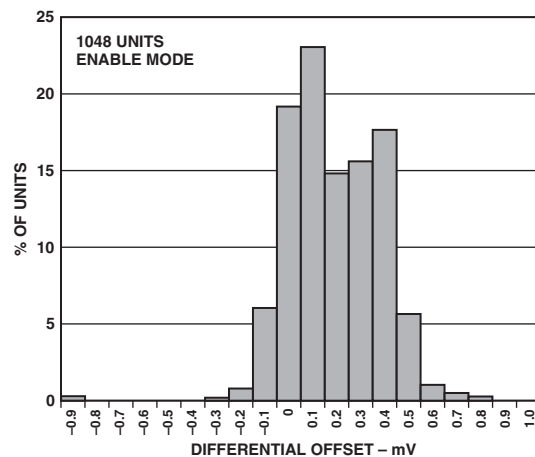

TPC 10. Differential Input Offset Histogram

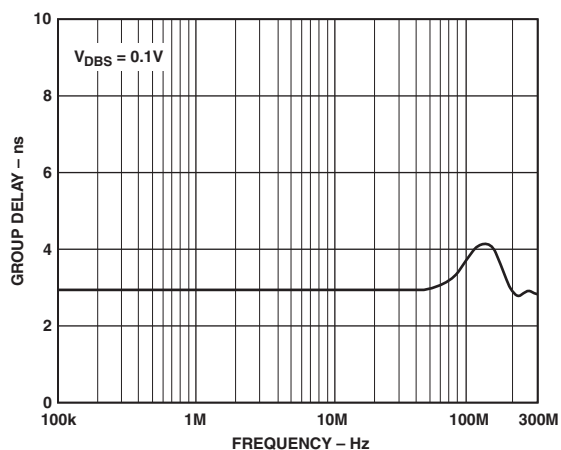

TPC 8. Group Delay vs. Frequency

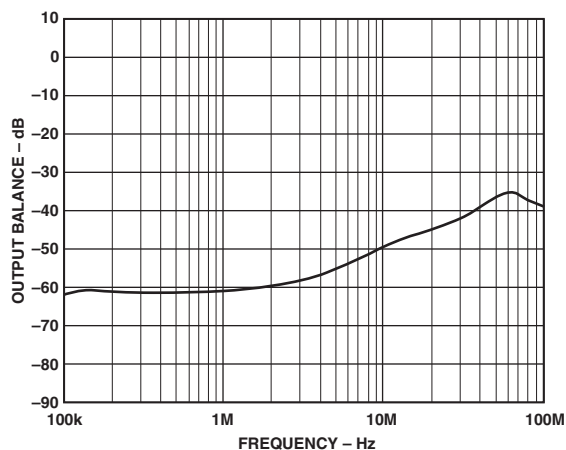

TPC 11. Output Balance Error vs. Frequency for a Representative Part

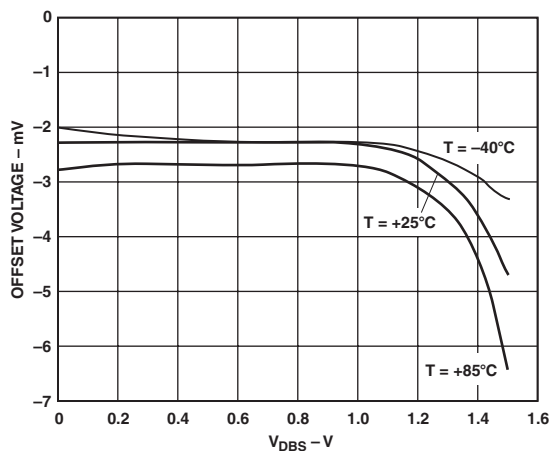

TPC 9. Differential Output Offset vs. V_{DBS} for Three Temperatures, for a Representative Part

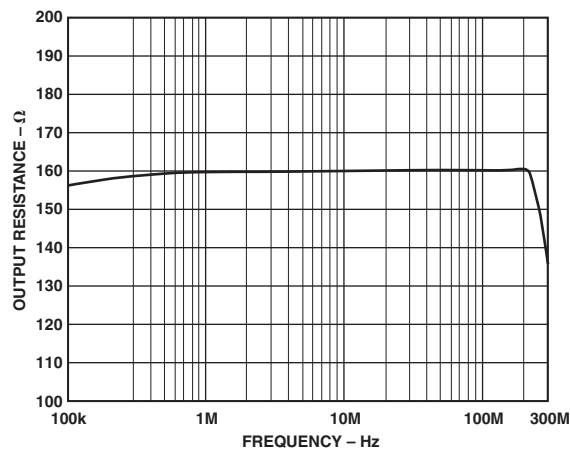

TPC 12. Output Impedance vs. Frequency

AD8330

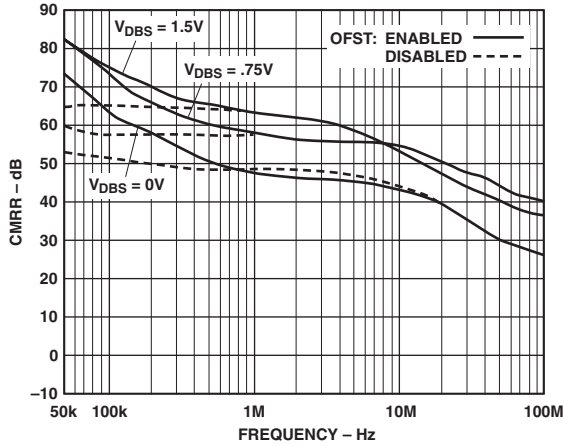

TPC 13. CMRR vs. Frequency

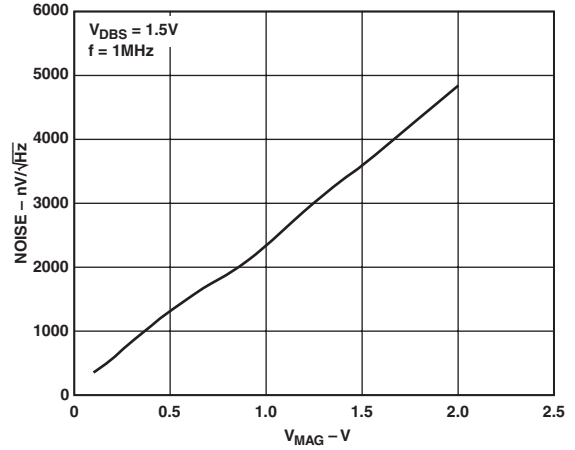

TPC 16. Output Referred Noise vs. V_{MAG}

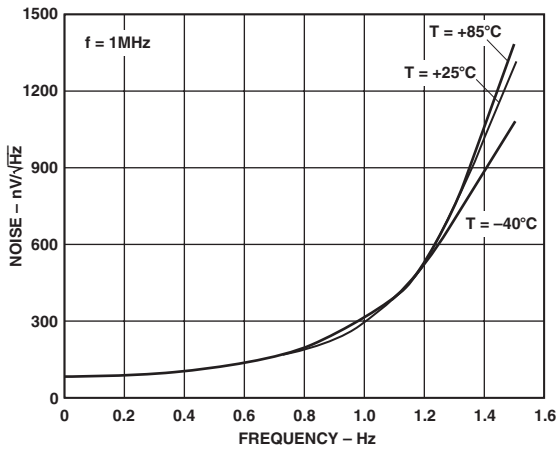

TPC 14. Output Referred Noise vs. V_{DBS} for Three Temperatures

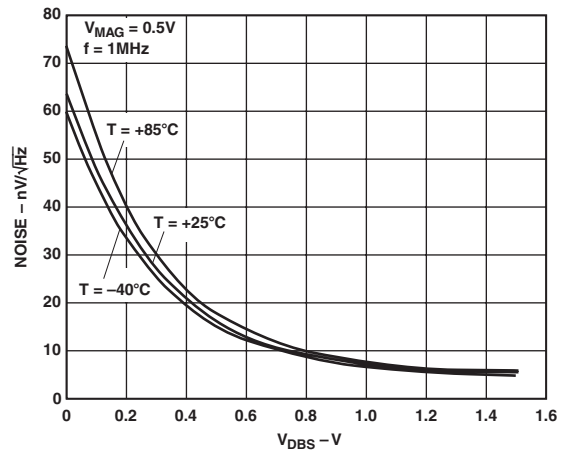

TPC 17. Input Referred Noise vs. V_{DBS} for Three Temperatures

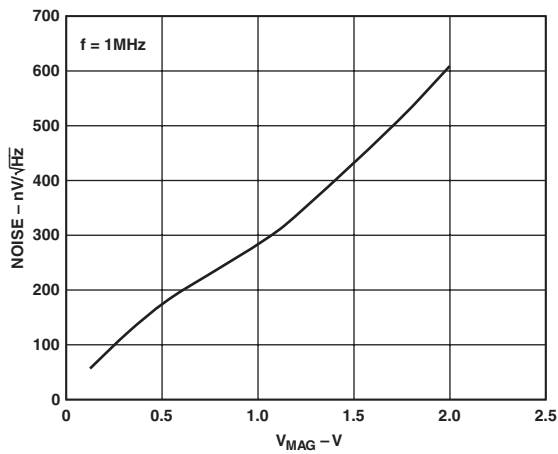

TPC 15. Output Referred Noise vs. V_{MAG}

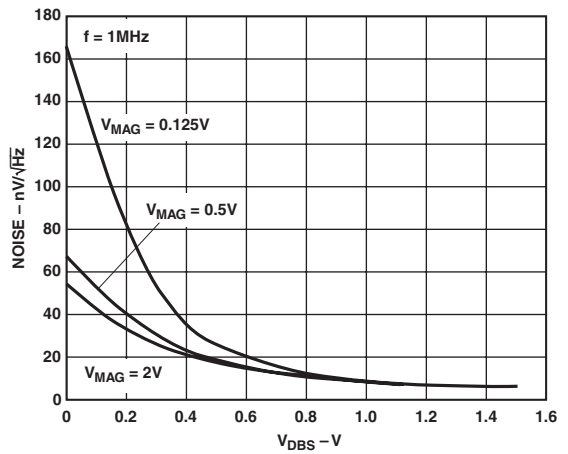

TPC 18. Input Referred Noise vs. V_{DBS} for Three Values of V_{MAG}

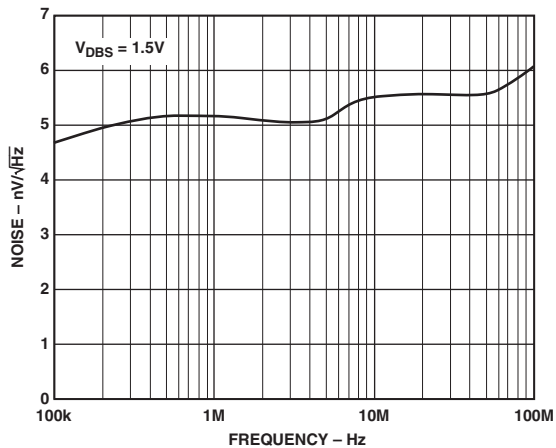

TPC 19. Input Referred Noise vs. Frequency

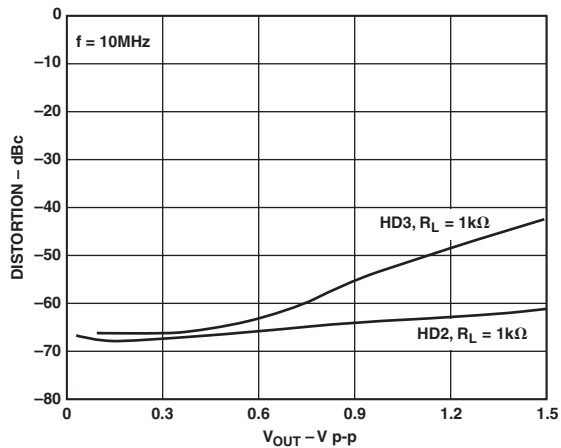

TPC 22. Harmonic Distortion vs. $V_{OUT-DIFFERENTIAL}$ $V_{MAG} = 0.5 V$

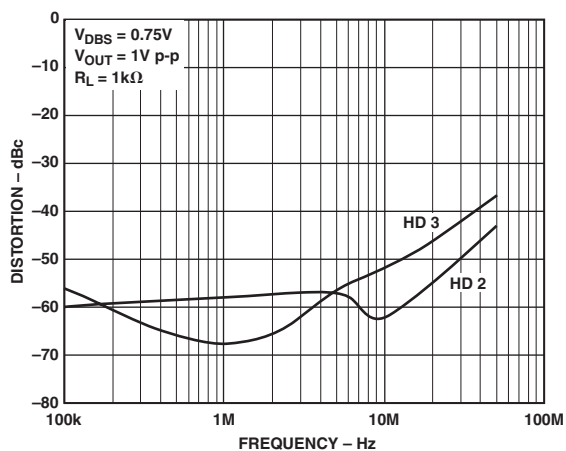

TPC 20. Harmonic Distortion vs. Frequency

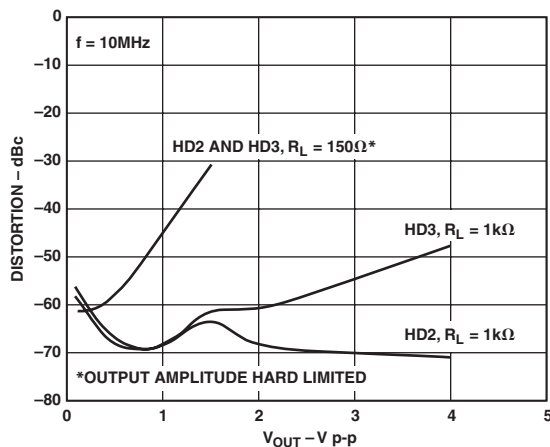

TPC 23. Harmonic Distortion vs. $V_{OUT-DIFFERENTIAL}$ $V_{MAG} = 2.0 V$

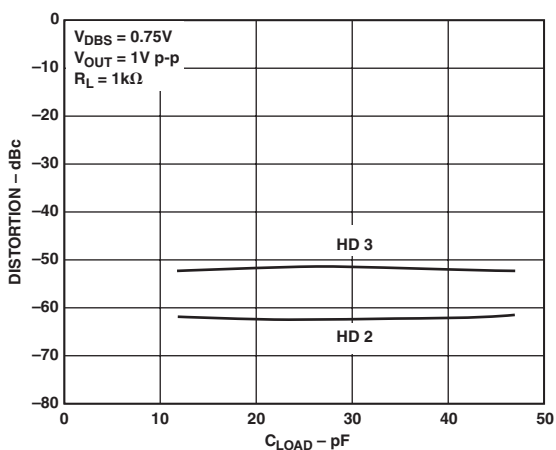

TPC 21. Harmonic Distortion vs. C_{LOAD}

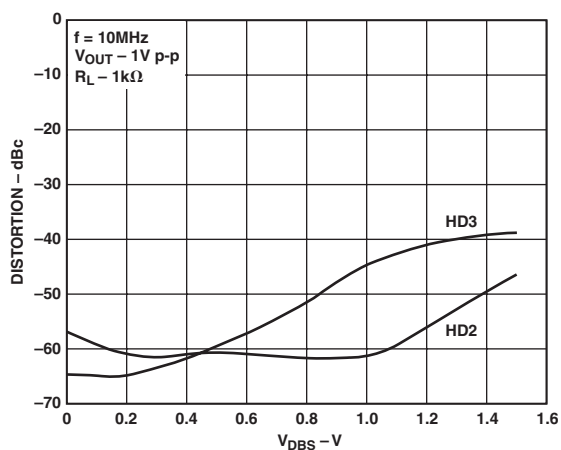

TPC 24. Harmonic Distortion vs. V_{DBS}

AD8330

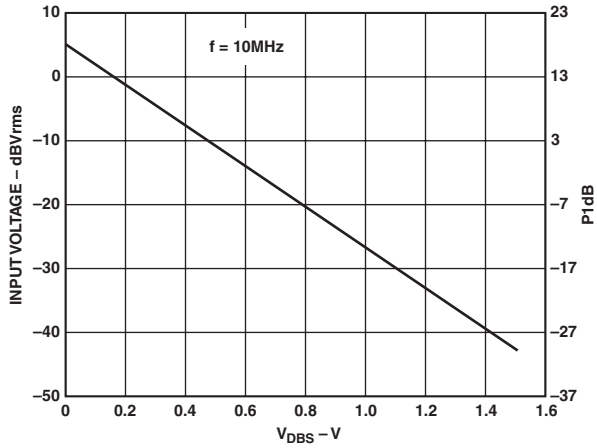

TPC 25. Input Voltage 1 dB vs. V_{DBS}

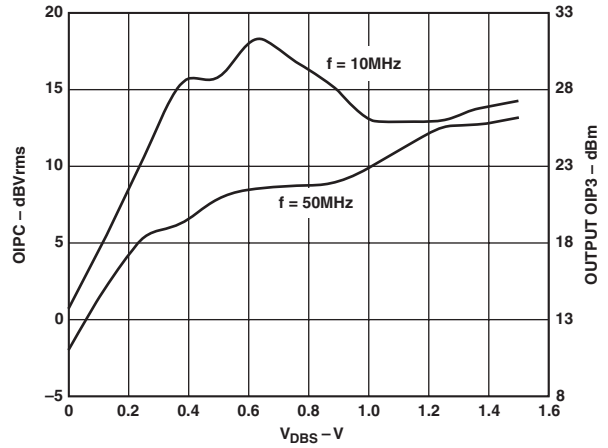

TPC 28. Output IP3 vs. V_{DBS}

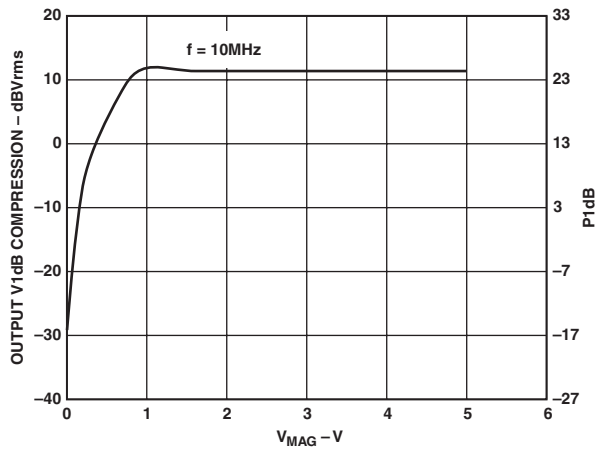

TPC 26. Output Voltage 1 dB vs. V_{MAG}

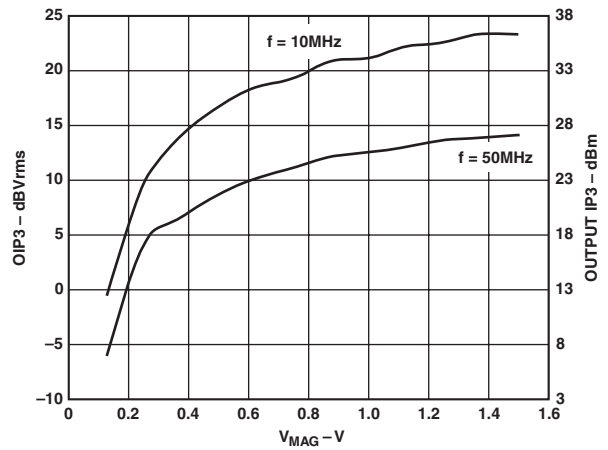

TPC 29. Output IP3 vs. V_{MAG}

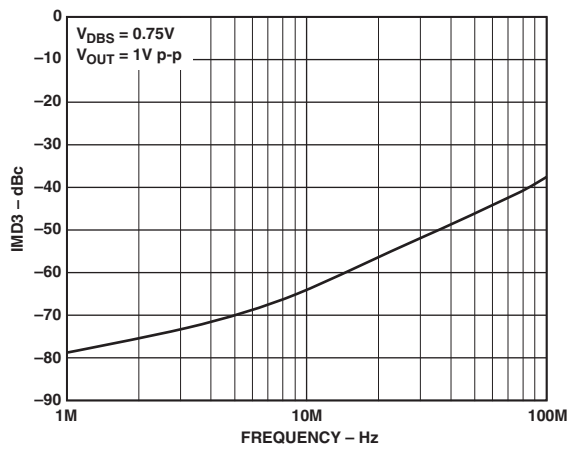

TPC 27. IM3 Distortion vs. Frequency

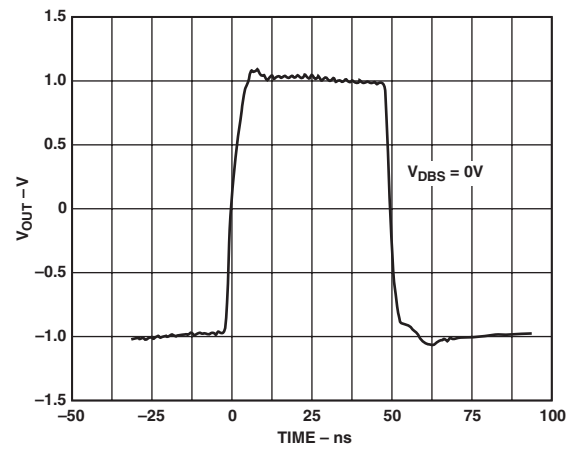

TPC 30. Full-Scale Transient Response, $V_{DBS} = 0\text{V}$

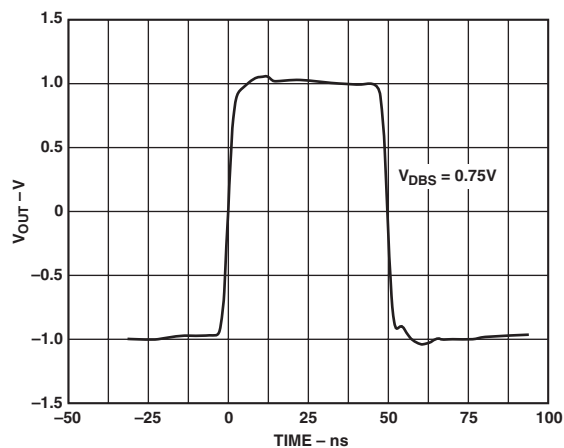

TPC 31. Full-Scale Transient Response, $V_{DBS} = 0.75\text{ V}$, $f = 1\text{ MHz}$, $V_{OUT} = 2\text{ V p-p}$

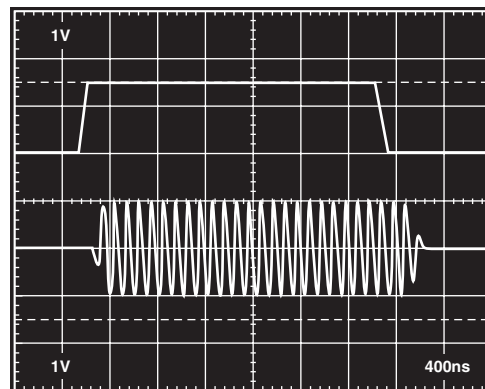

TPC 34. V_{DBS} Interface Response
Top: V_{DBS} , Bottom: V_{OUT}

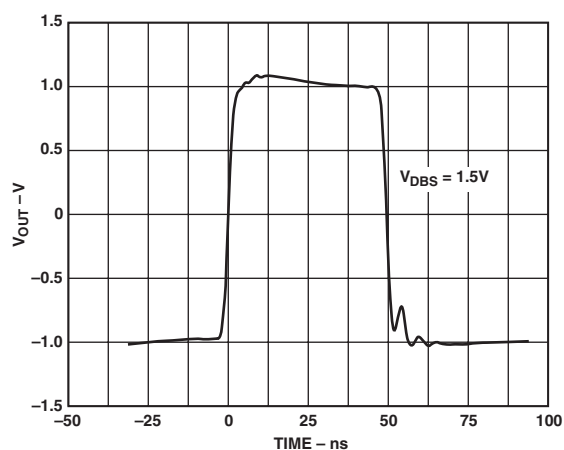

TPC 32. Full-Scale Transient Response, $V_{DBS} = 1.5\text{ V}$, $f = 1\text{ MHz}$, $V_{OUT} = 2\text{ V p-p}$

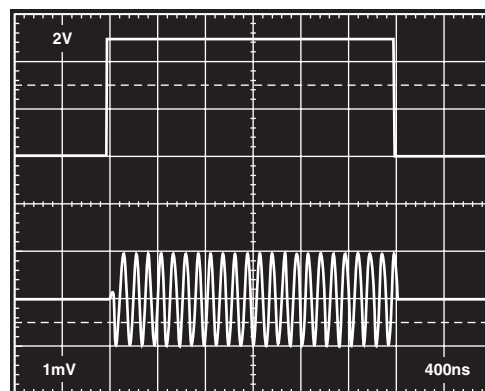

TPC 35. V_{MAG} Interface Response
Top: V_{MAG} , Bottom: V_{OUT}

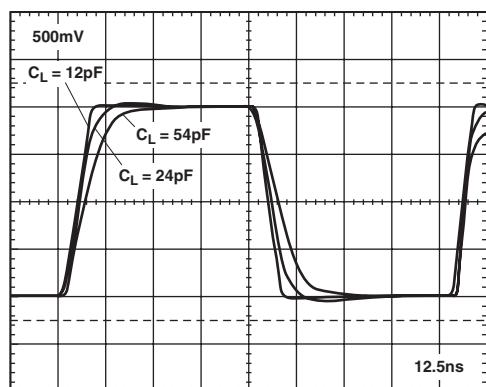

TPC 33. Transient Response vs. for Various Load Capacitances, $G = 25\text{ dB}$

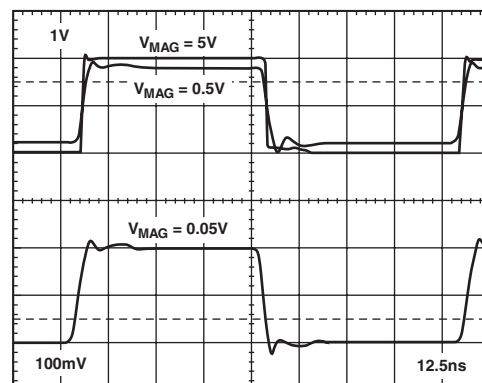

TPC 36. Transient Response vs. V_{MAG}

AD8330

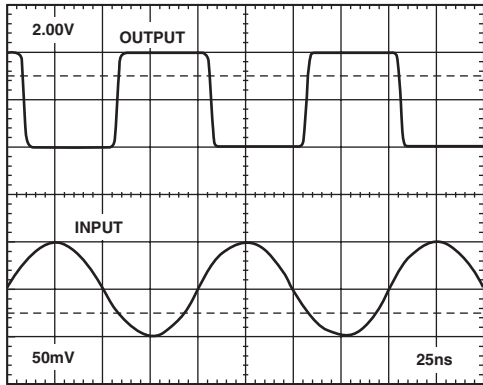

TPC 37. Overdrive Response, $V_{DBS} = 1.5 V$, $V_{MAG} = 0.5 V$, 18.5 dB Overdrive

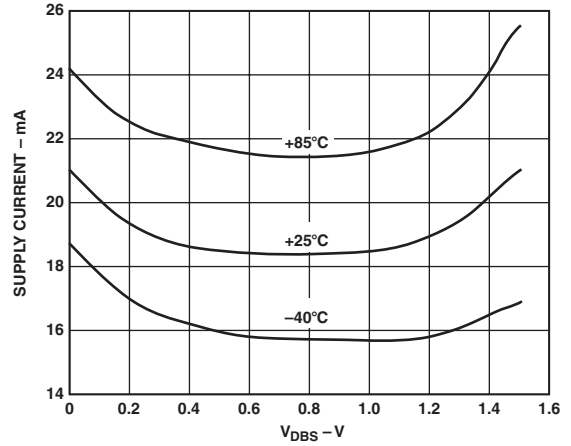

TPC 40. Supply Current vs. V_{DBS} at Three Temperatures

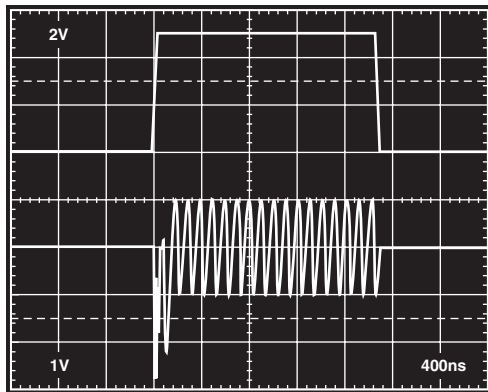

TPC 38. ENBL Interface Response. Top: V_{ENBL} ; Bottom: V_{OUT} , $f = 10 MHz$

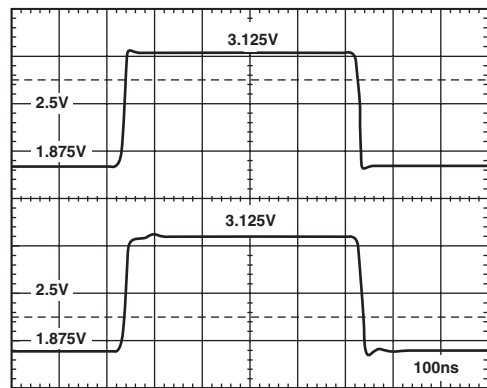

TPC 41. CNTR Transient Response
Top: Input to CNTR; Bottom, V_{OUT} Single Ended

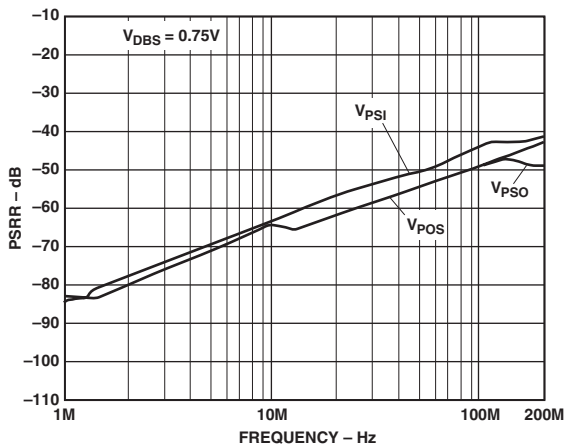

TPC 39. PSRR vs. Frequency

CIRCUIT DESCRIPTION

Many monolithic variable-gain amplifiers use techniques that share common principles that are broadly classified as translinear, a term referring to circuit cells whose functions depend directly on the very predictable properties of bipolar junction transistors, notably the linear dependence of their transconductance on collector current. Since the discovery of these cells in 1967, and their commercial exploitation in products developed during the early 1970s, accurate wide bandwidth analog multipliers, dividers, and variable-gain amplifiers have invariably employed translinear principles.

While these techniques are well understood, the realization of a high performance variable-gain amplifier (VGA) requires special technologies and attention to many subtle details in its design. The AD8330 is fabricated on a proprietary silicon-on-insulator, complementary bipolar IC process and draws on decades of experience in developing many leading-edge products using translinear principles to provide an unprecedented level of versatility.

Figure 2 shows a basic representative cell comprising just four transistors. This, or a very closely related form, is at the heart of most translinear multipliers, dividers, and VGAs. The key concepts are as follows: First, the ratio of the currents in the left-hand and right-hand pairs of transistors are identical; this is represented by the modulation factor, x , which may have values between -1 and $+1$. Second, the input signal is arranged to modulate the fixed tail current I_D to cause the variable value of x introduced in the left-hand pair to be replicated in the right-hand pair, and thus generate the output by modulating its nominally fixed tail current I_N . Third, the current-gain of this cell is very exactly $G = I_N/I_D$ over many decades of variable bias current. In practice, the realization of the full potential of this circuit involves many other factors, but these three elementary ideas remain essential.

By varying I_N , the overall function is that of a two-quadrant analog multiplier, exhibiting a linear relationship to both the signal modulation factor x and this numerator current. On the other hand, by varying I_D , a two-quadrant analog divider is realized, having a hyperbolic gain function with respect to the input factor x , controlled by this denominator current. The AD8330 exploits both modes of operation. However, since a hyperbolic gain function is generally of less value than one in which the decibel gain is a linear function of a control input, a special interface is included to provide either increasing or decreasing exponential control of I_D .

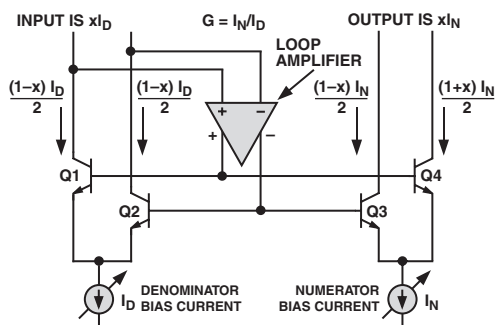

Figure 2. The Basic Core of the AD8330

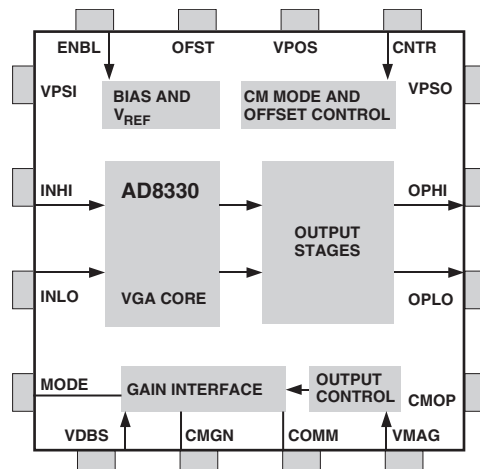

Figure 3. Block Schematic of the AD8330

Overall Structure

Figure 3 shows a block schematic of the AD8330 in which the key sections are located. More detailed discussions of its structure and features are provided later; this figure provides a general overview of its capabilities.

The VGA core contains a much elaborated version of the cell shown in Figure 2. The current called I_D is controlled exponentially (linear in decibels) through the decibel gain interface at the pin V_{DBS} and its local common $CMGN$. The gain span (that is, the decibel difference between maximum and minimum values) provided by this control function is slightly more than 50 dB. The absolute gain from input to output is a function of source and load impedance and also depends on the voltage on a second gain-control pin, $VMAG$, as will be explained in a moment.

Normal Operating Conditions

To minimize confusion, we define these normal operating conditions: the input pins are voltage driven (the source impedance is assumed to be zero); the output pins are open circuited (the load impedance is assumed to be infinite); pin $VMAG$ is unconnected, which sets up the output bias current (I_N in the four-transistor gain cell) to its nominal value; pin $CMGN$ is grounded; and $MODE$ is either tied to a logic high or left unconnected, to set the UP gain mode. The effects of other operating conditions can then be considered separately.

Throughout this data sheet, the end-to-end voltage gain for the normal operating conditions will be referred to as the Basic Gain. Under these conditions, it runs from 0 dB when $V_{DBS} = 0$ (where this voltage is more exactly measured with reference to pin $CMGN$, which may not necessarily be tied to ground) up to 50 dB for $V_{DBS} = 1.5$ V. The gain does not “fold-over” when the V_{DBS} pin is driven below ground or above its nominal full-scale value.

The input is accepted at the differential port INH/INL . These pins are internally biased to roughly the midpoint of the supply V_S (it is actually ~ 2.75 V for $V_S = 5$ V, $V_{DBS} = 0$, and 1.5 V for $V_S = 3$ V), but the AD8330 is able to accept a forced common-mode value, from zero to V_S , with certain limitations. This interface provides good common-mode rejection up to high frequencies (see TPC 13) and thus can be driven in either a single-sided or differential manner. However, operation using a differential drive is preferable, and this is assumed in the specifications, unless otherwise stated.

AD8330

The pin-to-pin input resistance is specified as $950\ \Omega \pm 20\%$. The driving-point impedance of the signal source may range from zero up to values considerably in excess of this resistance, with a corresponding variation in noise figure (see Figure 10). In most cases, the input will be coupled via two capacitors, chosen to provide adequate low frequency transmission. This results in the minimum input noise, which is increased when some other common-mode voltage is forced onto these pins, as explained later. The short circuit, input-referred noise at maximum gain is approximately $5\ \text{nV}/\sqrt{\text{Hz}}$.

The output pins OPHI/OPLO operate at a common-mode voltage at the midpoint of the supply, $V_S/2$, within a few millivolts. This ensures that an analog-to-digital converter (ADC) attached to these outputs operates within the often narrow range permitted by their design. When a common-mode voltage other than $V_S/2$ is required at this interface, it can easily be forced by applying an externally provided voltage to the output centering pin, CNTR. This voltage may run from zero to the full supply, though it must be noted that the use of such extreme values would leave only a small range for the differential output signal swing.

The differential impedance measured between OPHI and OPLO is $150\ \Omega \pm 20\%$. It follows that both the gain and the full-scale voltage swing will depend on the load impedance; both are nominally halved when this is also $150\ \Omega$. A fixed-impedance output interface, rather than an op amp style voltage-mode output, is preferable in high speed applications since the effects of complex reactive loads on the gain and phase can be better controlled. The top end of the AD8330's ac response is optimally flat for a $12\ \text{pF}$ load on each pin, but this is not critical and the system will remain stable for any value of load capacitance including zero.

Another useful feature of this VGA in connection with the driving of an ADC is that the peak output magnitude can be precisely controlled by the voltage on pin V_{MAG} . Usually, this voltage is internally preset to $500\ \text{mV}$, and the peak differential, unloaded output swing is $\pm 2\ \text{V} \pm 3\%$. However, any voltage from zero to at least $5\ \text{V}$ can be applied to this pin to alter the peak output in an exactly proportional way. Since either output pin can swing "rail to rail," which in practice means down to at least $0.35\ \text{V}$ and to within the same voltage below the supply, the peak-to-peak output between these pins can be as high as $10\ \text{V}$ using $V_S = 6\ \text{V}$.

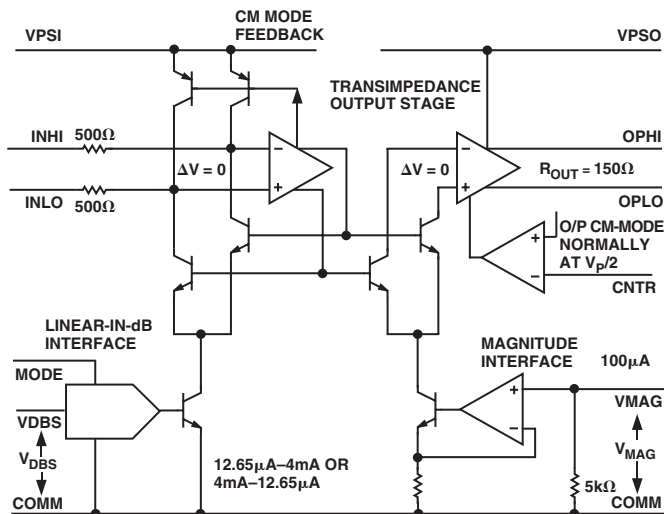

Figure 4. Schematic of Key Components

Linear-in-dB Gain Control (V_{DBS})

A gain control law that is linear in decibels is frequently claimed for VGAs based more loosely on these principles. However, closer inspection reveals that their conformance to this ideal gain function is poor, usually only an approximation over part of the gain range. Furthermore, the calibration (so many decibels per volt) is invariably left unspecified, and the resulting gain often varies wildly with temperature. All Analog Devices VGAs featuring a linear-in-dB gain law, such as the X-AMP™ family, provide exact, constant gain scaling over the fully specified gain range, and the deviation from the ideal response is within a small fraction of a dB. For the AD8330, the scaling of both its gain interfaces is substantially independent of process, supply voltage, or temperature. The Basic Gain, G_B , is simply:

$$G_B(\text{dB}) = \frac{V_{\text{DBS}}}{30\ \text{mV}} \quad (1)$$

where V_{DBS} is in volts. Alternatively, this can be expressed as a numerical gain magnitude:

$$G_{\text{BN}} = 10^{\frac{V_{\text{DBS}}}{0.6\ \text{V}}} \quad (2)$$

As discussed later, the gain may be increased or decreased by changing the voltage V_{MAG} applied to the VMAG pin. The internally set default value of $500\ \text{mV}$ is derived from the same band gap reference that determines the decibel scaling. The tolerance on this voltage, and mismatches in certain on-chip resistors, cause small gain errors (see Specifications). While not all applications of VGAs demand accurate gain calibration, there are many situations in which it will be a valuable asset, for example, in reducing design tolerances.

Figure 4 shows the core circuit in somewhat more detail. The range and scaling of V_{DBS} is independent of the supply voltage, and the gain-control pin, VDBS, presents a high incremental input resistance ($\sim 100\ \text{M}\Omega$) with a low bias current ($\sim 100\ \text{nA}$), making the AD8330 easy to drive from a variety of gain-control sources.

Inversion of the Gain Slope

The AD8330 supports many new features that further extend the versatility of this VGA in wide bandwidth, gain-control systems. For example, the logic pin MODE allows the slope of the gain function to be inverted, so that the basic gain starts at $+50\ \text{dB}$ for a gain voltage V_{DBS} of zero and runs down to $0\ \text{dB}$ when this voltage is at its maximum specified value of $1.5\ \text{V}$. The basic forms of these two gain control modes are shown in Figure 5.

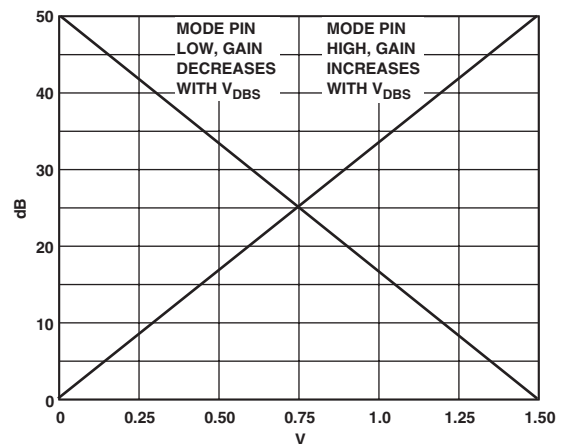

Figure 5. The Two Gain Directions of the AD8330

Gain Magnitude Control (V_{MAG})

In addition to the basic linear-in-dB control, two more gain-control features are provided. The voltage applied to pin VMAG provides accurate linear-in-magnitude gain control with a very rapid response. The bandwidth of this interface is >100 MHz. When this pin is unconnected, V_{MAG} assumes its default value of 500 mV (see Figure 4) to set up the basic 0 dB–50 dB range. But any voltage from ~15 mV to 5 V may be applied to either lower the gain by up to 30 dB or to raise it by 20 dB. The combined gain span is thus 100 dB, that is, the 50 dB Basic Gain span provided by V_{DBS} plus a 60 dB linear-in-magnitude span provided by V_{MAG} . The latter modifies the basic numerical gain G_{BN} to generate a total gain, expressed here in magnitude terms:

$$G_T = G_{BN} \frac{V_{MAG}}{0.5 \text{ V}} \quad (3)$$

Using this to calculate the output voltage, we can write:

$$V_{OUT} = 2G_{BN} V_{IN} V_{MAG} \quad (4)$$

from which it is apparent that the AD8330 implements a linear, two-quadrant multiplier with a bipolar V_{IN} and a unipolar V_{MAG} . Since the AD8330 is a dc-coupled system (the management of dc offsets at high gains is discussed later), it may be used in many applications where a wideband two-quadrant multiplier function is required, from dc up to about 100 MHz from either input (V_{IN} or V_{MAG}).

As V_{MAG} is varied, so also is the peak output magnitude, up to a point where this is limited by the absolute output limit imposed by the supply voltage. In the absence of the latter effect, the peak output into an open circuited load is just:

$$V_{OUT_PK} = \pm 2V_{MAG} \quad (5)$$

while for a load resistance of R_L directly across OPHI and OPLO, it is:

$$V_{OUT_PK} = \frac{\pm 2V_{MAG}R_L}{(R_L + 150)} \quad (6)$$

These capabilities are illustrated, first in Figure 6, where $V_S = 6 \text{ V}$, $R_L = \text{O/C}$, $V_{DBS} = 0 \text{ V}$, V_{IN} was swept from -2.5 to $+2.5 \text{ VDC}$ and V_{MAG} was set to 0.25 V, 0.5 V, 1 V, and 2 V. Except for the last value of V_{MAG} , the peak output follows Equation 5; this exceeds the supply-limited value when $V_{MAG} = 2 \text{ V}$ and the peak output is $\pm 5.65 \text{ V}$, that is, $\pm 6 \text{ V} - 0.35 \text{ V}$. Figure 7 demonstrates the high speed multiplication capability. The signal input is a 100 MHz, 0.1 V sine wave, V_{DBS} is set to 0.6 V, and V_{MAG} is a square wave at 5 MHz alternating from 0.25 V to 1 V. The output is ideally a sine wave switching in amplitude between 0.5 V and 2 V.

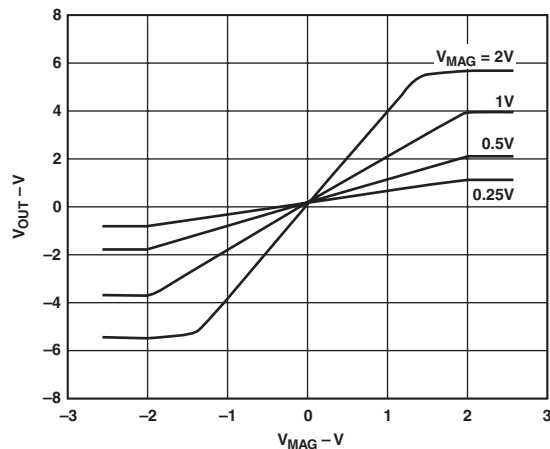

Figure 6. Effect of V_{MAG} on Gain and Peak Output

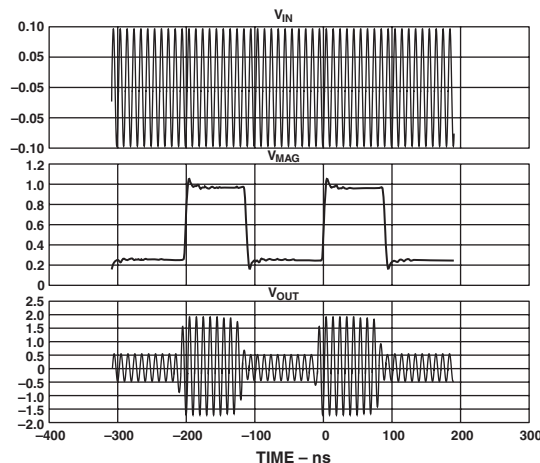

Figure 7. Using VMAG in Modulation Mode

Another gain-related feature allows both of the gain control ranges to be accurately raised by 200 mV. To enable this offset, open-circuit Pin 6 (CMGN) and add a 0.1 μF capacitor to ground. In use, the nominal range for V_{DBS} now extends from 0.2 V to 1.7 V and V_{MAG} from 0.2 V to 5.2 V. These specifications apply for any supply voltage. This allows the use of DACs whose output range does not include ground, as sources for the gain control function(s).

Note that the 200 mV that appears on this pin will affect the response to an externally-applied V_{MAG} , but when pin VMAG is unconnected, the internally set default value of 0.5 V still applies. Furthermore, the pin CMGN can, if desired, be driven by a user supplied voltage to reposition the baseline for V_{DBS} (or for an externally applied V_{MAG}) to any other voltage up to 500 mV. In all cases, the gain scaling, its law conformance, and temperature stability are unaffected.

Two Classes of Variable-Gain Amplifiers

It may be noted at this point that there are two broad classes of VGA. The first type is designed to cope with a very wide range of input amplitudes and, by virtue of its gain control function, compress this range down to an essentially constant output. This is the function needed in an AGC system. Such a VGA is called an IVGA, referring to a structure optimized to address a wide range of input amplitudes. By contrast, an OVGA is optimized to deliver a wide range of output values while operating with an essentially constant input amplitude. This is the function that might be needed, for example, in providing a variable drive to a power amplifier.

It will be apparent from the foregoing that the AD8330 is both an IVGA and an OVGA in the one package. This is an unusual and possibly confusing degree of versatility for a VGA; consequently we will generally discuss these two distinct control functions at separate points throughout this data sheet, in explaining the operation and applications of this product. It is nevertheless useful to briefly demonstrate the capabilities of these features when used together.

AD8330

Amplitude/Phase Response

The ac response of the AD8330 is remarkably consistent not only over the full 50 dB of its basic gain range, but also with changes of gain due to alteration of V_{MAG} , as demonstrated in Figure 8. This is an overlay of two sets of results: first with a very low V_{MAG} of 16 mV, which reduces the overall gain by 30 dB [$20 \times \log_{10}(500 \text{ mV}/16 \text{ mV})$]; second, with $V_{MAG} = 5 \text{ V}$, which increases the gain by 20 dB = $20 \times \log_{10}(5 \text{ V}/0.5 \text{ V})$.

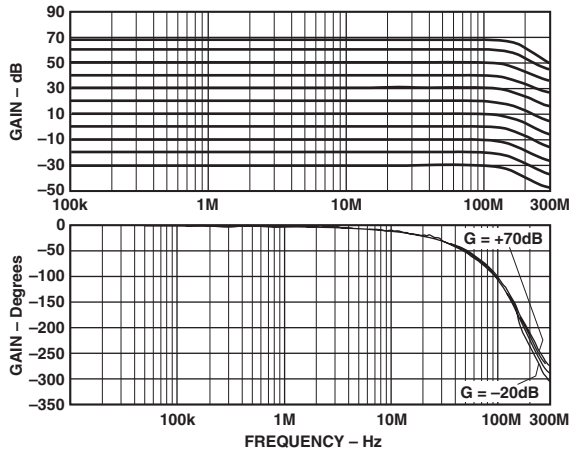

Figure 8. AC Performance over a 100 dB Gain Range Obtained by Using Two Values of V_{MAG}

This 50 dB step change in gain produces the two sets of gain curves, having a total gain span of 100 dB. It is apparent that the amplitude and phase response are essentially independent of the gain over this wide range, an aspect of the AD8330's performance potential unprecedented in any prior VGA.

It is unusual for an application to require such a wide range of gains, of course; and as practical matter, the peak output voltage for $V_{MAG} = 16 \text{ mV}$ is reduced by the factor 16/500, compared to its nominal value of $\pm 2 \text{ V}$, to only $\pm 64 \text{ mV}$. As already noted, most applications of VGAs require that they operate in a mode that is predominantly of either an IVGA or OVGA style, rather than mixed modes.

With this limitation in mind, and simply in order to illustrate the unusual possibilities afforded by the AD8330, it is noted that with appropriate drive to V_{DBS} and V_{MAG} in tandem, the gain span is a remarkable 120 dB, extending from -50 dB to $+70 \text{ dB}$, as shown in Figure 9 for operation at 1 MHz and 100 MHz. In this case, V_{DBS} and V_{MAG} are driven from a common control voltage, V_{GAIN} , which is varied from 1.2 mV to 5 V, with 30% (1.5/5) of V_{GAIN} applied to V_{DBS} , and 100% applied to V_{MAG} .

The gain varies in a linear-in-dB manner with V_{DBS} , while the response from V_{MAG} is linear-in-magnitude. Consequently, the overall numerical gain is the product of these two functions:

$$GAIN = V_{GAIN} / 0.5 \text{ V} \times 0.3 \times 10^{\frac{V_{GAIN}}{0.6 \text{ V}}} \quad (7)$$

In rare cases where such a wide gain range might be of value, the calibration will still be accurate and temperature stable.

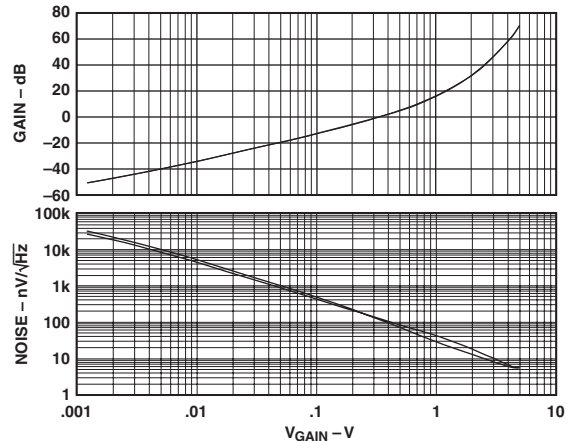

Figure 9. Gain Control Function and Input Referred Noise Spectral Density over a 120 dB Range

Noise, Input Capacity and Dynamic Range

The design of variable-gain amplifiers invariably incurs some compromises in noise performance. However, the structure of the AD8330 is such that this penalty is minimal. Examination of the simplified schematic (Figure 4) shows that the input voltage is converted to current-mode form by the two 500Ω resistors at pins INHI and INLO, whose combined Johnson noise contributes $4.08 \text{ nV}/\sqrt{\text{Hz}}$. The total input noise at full gain, when driven from a low impedance source, is typically $5 \text{ nV}/\sqrt{\text{Hz}}$ after accounting for the voltage and current noise contributions of the loop amplifier. For a 200 kHz channel bandwidth, this amounts to $2.24 \mu\text{V rms}$. The peak input at full gain is $\pm 6.4 \text{ mV}$, or $+4.5 \text{ mV rms}$ for a sine wave signal. The signal-to-noise ratio at full input, that is, the dynamic range, for these conditions is thus $20 \log_{10}(4.5 \text{ mV}/2.24 \mu\text{V})$, or 66 dB. The value of V_{MAG} has essentially no effect on the input-referred noise, but we assume it to be 0.5 V.

Below midgain (25 dB, $V_{DBS} = 0.75 \text{ V}$), noise in the output section dominates, and the total input noise is $11 \text{ nV}/\sqrt{\text{Hz}}$, or $4.9 \mu\text{V rms}$ in a 200 kHz bandwidth, while the peak input is 78 mV rms . Thus, the dynamic range has increased to 84 dB. At minimum gain, the input noise is up to $120 \text{ nV}/\sqrt{\text{Hz}}$, or 53.7 mV rms in the assumed 200 kHz bandwidth, while the input capacity is $\pm 2 \text{ V}$, or $+1.414 \text{ V rms}$ (sine), a dynamic range of 88.4 dB. In calculating the dynamic range for other channels bandwidths, Δf , subtract $10 \log_{10}(\Delta f / 200 \text{ kHz})$ from these illustrative values. A system operating with a 2 MHz bandwidth, for example, will exhibit dynamic range values that are uniformly 10 dB lower; used in an audio application with a 20 kHz bandwidth, they will be 10 dB higher.

Noise figure is a misleading metric for amplifiers that are not impedance matched at their input, which is the special condition resulting only when both the voltage and current components of a signal, that is, the signal power, are used at the input port. When a source of impedance R_S is terminated using a resistor of R_S (a condition that is not to be confused with matching), only one of these components is used, either the current (as in the AD8330) or the voltage. Then, even if the amplifier is perfect, the noise figure cannot be better than 3 dB. The $1 \text{ k}\Omega$ internal termination resistance would result in a minimum noise figure of 3 dB for an R_S of $1 \text{ k}\Omega$ if the amplifier were noise-free. However, this is not the case and the minimum noise figure will occur at a slightly different value of R_S (see Figure 10 and Using the AD8330).

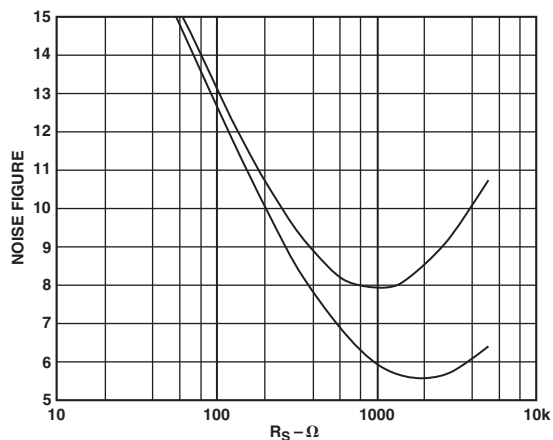

Figure 10. Noise Figure for Source Resistance of 50 Ω to 5 k Ω , at $f = 10$ MHz (lower) and 100 MHz (Simulation)

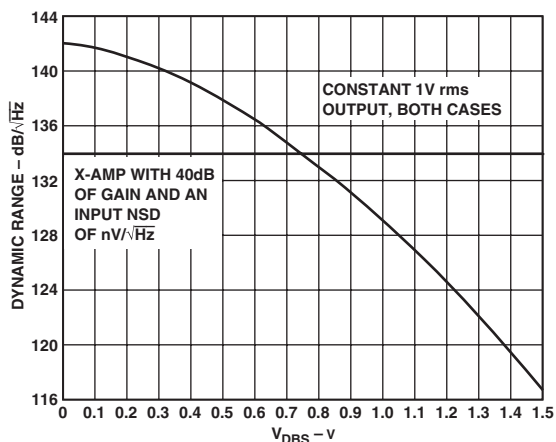

Figure 11. Dynamic Range in $\text{dB}/\sqrt{\text{Hz}}$ vs. V_{DBS} ($V_{\text{MAG}} = 0.5$ V, 1 V rms output) Compared with a Representative X-AMP (Simulation)

Dynamic Range

The ratio of peak output swing, expressed in rms terms, to the output-referred noise-spectral-density provides a measure of dynamic range, in $\text{dB}/\sqrt{\text{Hz}}$. For a certain class of variable-gain amplifiers, exemplified by Analog Devices' X-AMP family, the dynamic range is essentially independent of the gain setting, because the peak output swing and noise are both constant. The AD8330 provides a different dynamic-range profile, since there is no longer a constant relationship between these two parameters. Figure 11 compares the dynamic range of the AD8330 to a representative X-AMP.

Input Common-Mode Range and Rejection Ratio

The inputs INHI and INLO should be ac-coupled in most applications, to achieve the stated noise performance. When direct coupling is used, care must be taken in setting the dc voltage level at these inputs, in general, and particularly when minimizing noise is critical. This objective is complicated by the fact that the common-mode level varies with the basic gain voltage V_{DBS} . Figure 12 shows this relationship for a supply voltage of 5 V, for temperatures of -35°C , $+25^\circ\text{C}$ and $+85^\circ\text{C}$. Figure 13 shows the input noise-spectral-density ($R_S = 0$) versus the input common-mode voltage, for $V_{\text{DBS}} = 0.5$ V, 0.6 V, 0.75 V, and 1.5 V. It is apparent that there is a broad range over which the noise is unaffected by this dc level. The input CMRR is excellent (see TPC 13).

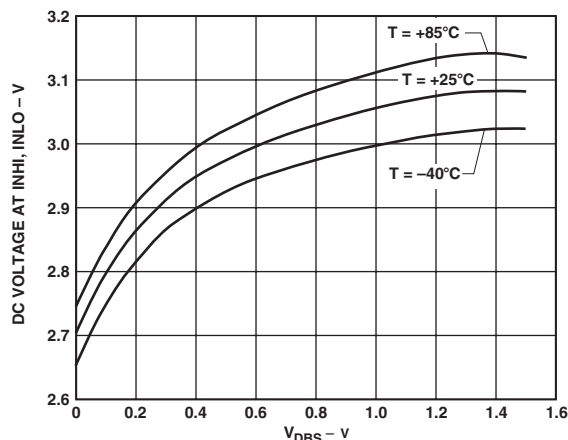

Figure 12. Common-Mode Voltage at Input Pins vs. V_{DBS} , for $V_S = 5$ V, $T = -35^\circ\text{C}$, $+25^\circ\text{C}$, and $+85^\circ\text{C}$

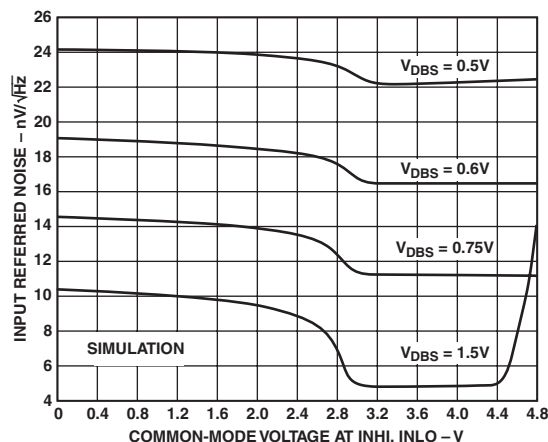

Figure 13. Input Noise vs. Common-Mode Input Voltage for $V_{\text{DBS}} = 0.5$ V, 0.6 V, 0.75 V, and 1.5 V

Output Noise and Peak Swing

The output noise of the AD8330 is the input noise multiplied by the overall gain, which includes any optional change to the voltage V_{MAG} applied to pin VMAG. The peak output swing is also proportional to this voltage, which, at low gains and high values of V_{MAG} , will affect the output noise. The scaling for $V_{\text{DBS}} = 0$ is as follows:

$$V_{\text{OUT_PK}} = \pm 4 V_{\text{MAG}} \quad (8)$$

$$V_{\text{NOISE_OUT}} = (85 + 70 V_{\text{MAG}}) \text{ nV} / \sqrt{\text{Hz}} \quad (9)$$

For example, using a reduced value of $V_{\text{MAG}} = 0.25$ V, which lowers all gain values by 6 dB, the peak output swing is ± 1 V (differentially) and the output noise spectral density evaluates to $102.5 \text{ nV}/\sqrt{\text{Hz}}$. The peak output swing is no different at full gain, but the noise is now

$$V_{\text{NOISE_OUT}} = (0.1 + 0.32 V_{\text{MAG}}) \mu\text{V} / \sqrt{\text{Hz}} \quad (10)$$

for $R_S = 0$ and $V_{\text{DBS}} = 1.5$ V, assuming an input noise of $5 \text{ nV}/\sqrt{\text{Hz}}$. The output noise for very small values of V_{MAG} (at or below 15 mV) is not precise, partly because the small input offset associated with this interface has a large effect on the gain.

AD8330

Offset Compensation

The AD8330 includes an offset compensation feature, which is operational in the default condition (no connection to pin OFST). This loop introduces a high-pass filter function into the signal path, whose -3 dB corner frequency is at:

$$f_{HPF} = \frac{1}{(2\pi R_{INT} C_{HP})} \quad (11)$$

where C_{HP} is the external capacitance added from OFST to CNTR, and R_{INT} is an internal resistance of approximately 480Ω , having a maximum uncertainty of about $\pm 20\%$. This evaluates to:

$$f_{HPF} \approx \frac{330\mu}{C_{HP}} \quad (C_{HP} \text{ in } \mu F) \quad (12)$$

A small amount of peaking at this corner when using small capacitor values can be avoided by adding a series resistor. Useful combinations are $C_{HP} = 3$ nF, $R_{HP} = 180 \Omega$, $f = 100$ kHz; $C_{HP} = 33$ nF, $R_{HP} = 10 \Omega$, $f = 10$ kHz; $C_{HP} = 0.33 \mu F$, $R_{HP} = 0 \Omega$, $f = 1$ kHz; $C_{HP} = 3.3 \mu F$, $R_{HP} = 0 \Omega$, $f = 100$ Hz.

The offset compensation feature can be disabled simply by grounding the OFST pin. This provides a dc-coupled signal path, with no other effects on the overall ac response. Input offsets must be externally nulled in this mode of operation, as shown in Figure 15.

Effects of Loading on Gain and AC Response

The differential output impedance R_O is 150Ω and the frequency response of the output stage is optimized for operation with a certain load capacitance on each output pin, OPHI and OPLO, to ground, in combination with a load resistance R_L directly across these pins. In the absence of these capacitances, there will be a small amount of peaking at the top extremity of the ac response. Suitable combinations are: $R_L = \infty$, $C_L = 12$ pF; $R_L = 150 \Omega$, $C_L = 25$ pF; $R_L = 75 \Omega$, $C_L = 40$ pF; $R_L = 50 \Omega$, $C_L = 50$ pF.

The gain calibration is specified for an open-circuited load, such as the high input resistance of an ADC. When resistively loaded, all gain values are nominally lowered as follows:

$$G_{LOADED} = \frac{G_{UNLOADED} R_L}{(150 \Omega + R_L)} \quad (13)$$

Thus when $R_L = 150 \Omega$, the gain is reduced by 6 dB; for $R_L = 75 \Omega$, the reduction is 9.5 dB; and for $R_L = 50 \Omega$, it is 12 dB.

Gain Errors Due to On-Chip Resistor Tolerances

In all cases where external resistors are used, keep in mind that all on-chip resistances, including the R_O and the input resistance, R_I , are subject to variances of up to $\pm 20\%$, which will need to be accounted for when calculating the gain with input and output loading. This sensitivity can be avoided by adjusting the source and load resistances to bear an inverse relationship as follows: If $R_S = \alpha R_I$ then make $R_L = R_O / \alpha$; or, if $R_L = \alpha R_O$ then make $R_S = R_I / \alpha$. The simplest case is when $R_S = 1$ k Ω and $R_L = 150 \Omega$. Here the gain is 12 dB lower than the basic value. The reduction of peak swing at the load can be corrected by using $V_{MAG} = 1$ V, which also restores 6 dB of gain; using $V_{MAG} = 2$ V restores the full basic gain while also doubling the peak available output swing.

Output (Input) Common-Mode Control

The output voltages are nominally positioned at the midpoint of the supply, $V_S/2$, over the range 2.7 V $< V_S < 6$ V, and this voltage appears at pin CNTR, which is not normally expected to be loaded (the source resistance is ~ 4 k Ω). However, some circumstances may require a small change in this voltage, and a resistor

from CNTR to ground can lower this voltage, or one to the supply will raise it. On the other hand, this pin may be driven by an external voltage source to set the common-mode level, to satisfy the needs of a following ADC, for example. Any value from 0.5 V above ground to 0.5 V below the supply is permissible. Of course, when using an extreme common-mode level, the available output swing will be limited, and it is recommended that a value equal or close to the default of $V_{CNTR} = V_S/2$ be used. There may be a few millivolts of offset between the applied voltage and the actual common-mode level at the output pins.

The input common-mode voltage V_{CMI} at pins INHI, INLO is slaved to the output, but with a shifted value:

$$V_{CMI} = 0.757 V_{CNTR} + 1.12 \text{ V} \quad (14)$$

for $V_{DBS} = 0.75$ and $T = 25^\circ\text{C}$. Thus, the default value for V_{CMI} when $V_S = 5$ V is 3.01 V (see Figure 12).

USING THE AD8330

There are very few precautions that need to be observed in applying the AD8330 to a wide variety of circumstances. A selection of specific applications is presented later. Here we discuss a few general aspects of utilization.

As in all high frequency circuits, careful observation of the ground nodes associated with each function is important. Three positive supply pins are provided. VPSI supports the input circuitry, which may often be operating at a relatively high sensitivity; VPOS, which supports general bias sources, needs no decoupling; VPSO is used to bias the output stage, where decoupling may be useful in maintaining a glitch-free output. Figure 14 shows the general case, where VPSI and VPSO are each provided with their own decoupling network, but this may not be needed in all cases.

Because of the differential nature of the signal path, power-supply decoupling is in general much less critical than in a single-sided amplifier, and where the minimization of board-level components is especially crucial, it may be found that these pins need no decoupling at all. On the other hand, when the signal source is

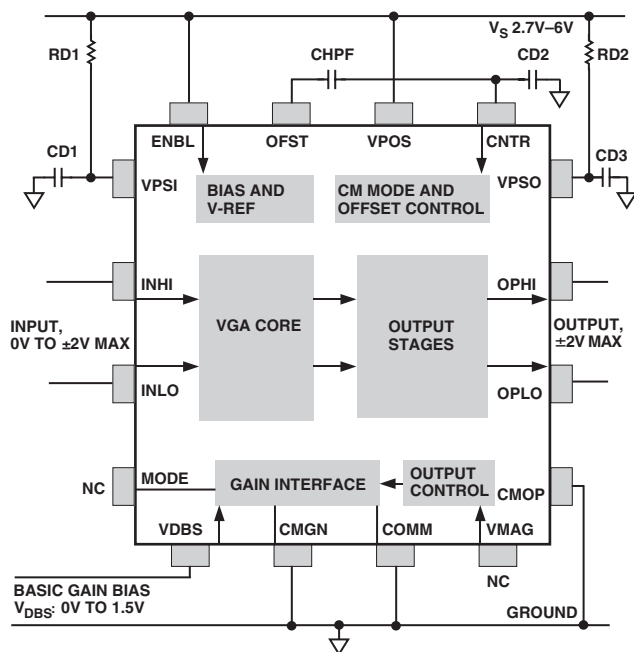

Figure 14. Power Supply Decoupling and Basic Connections

single-sided extra attention may be needed to the decoupling on pin VPSI, while if the output is loaded on only one of its two output pins, this may require care in decoupling the VPSO pin. The general common COMM and the output stage common CMOP are usually grounded as shown in the figure; however, the Applications section shows how a negative supply can optionally be used.

The AD8330 is enabled by taking the ENBL pin to a logical high (or, in all cases, the supply). The “UP” gain mode is enabled either by leaving the MODE pin unconnected or taken to a logical HI; when the opposite gain direction is needed, this pin should be grounded or driven to a logical low. The low-pass corner of the offset loop is determined by the capacitor CHPF; this is preferably tied to the CNTR pin, which in turn should be decoupled to ground. The gain-interface common pin CMGN is grounded, and the output magnitude control pin V_{MAG} is left unconnected, or may optionally be connected to a 500 mV source for basic gain calibration.

Connections to the input and output pins are not shown in this figure because of the many options that are available. When the AD8330 is used to drive an ADC, pins OPHI and OPLO may be connected directly to the differential inputs of a suitable converter, such as an AD9214. If an adjustment is needed to this common-mode level, it can be introduced by applying that voltage to CNTR, or, more simply, by using a resistor from this pin to either ground or the supply (see APPLICATIONS). This pin can also supply the common-mode voltage to an ADC that supports such a feature.

When the loads to be driven introduce a dc resistive path to ground, coupling capacitors must be used; these should be of sufficient value to pass the lowest frequency components of the signal without excessive attenuation. Keep in mind that the voltage swing on such loads will alternate both above and below ground, requiring that the subsequent component must be able to cope with negative signal excursions.

Gain and Swing Adjustments When Loaded

The output can also be coupled to a load via a transformer, in which case it may be possible to achieve a higher load power by impedance transformation. For example, using a 2:1 turns ratio, a 50 Ω final load will present a 200 Ω load on the output. The gain loss (relative to the basic value with no termination) will be $20 \log_{10}\{(200+150)/200\}$ or 4.86 dB, which can be restored by raising the voltage on the V_{MAG} pin by a factor of $10^{4.86/20}$ or $\times 1.75$, from its basic value of 0.5 V to 0.875 V. This also restores the peak swing at the 200 Ω level to ± 2 V, or ± 1 V into the 50 Ω final load.

Whenever a stable supply voltage is available, the additional voltage may be provided simply by adding a resistor from this pin to the supply. The calculation is based on knowing that the internal bias is delivered via a 5 k Ω source; since an additional 0.375 V is needed, the current in this external resistor must be $0.375 \text{ V}/5 \text{ k}\Omega = 75 \mu\text{A}$. Thus, using a 5 V supply, a resistor of $5 \text{ V}-0.875 \text{ V}/75 \mu\text{A} = 55 \text{ k}\Omega$ would be used. Based on this example, the corrections for other load conditions should be easy to calculate. If the effects on gain and peak output swing due to supply variations cannot be tolerated, V_{MAG} must be driven by an accurate voltage.

Input Coupling

The dc common-mode voltage at the input pins varies with the supply, the basic gain bias and temperature (see Figure 12); for this reason, many applications will need to use coupling capacitors from the source, which should be large enough to support the lowest frequencies to be transmitted. Using one capacitor at

each input pin, their minimum value can be readily found from this expression:

$$C_{IN_CPL} = \frac{320 \mu\text{F}}{f_{HPF}} \quad (15)$$

where f_{HPF} is the -3dB frequency expressed in hertz. Thus, for an f_{HPF} of 10 kHz, 33 nF capacitors would be used.

It may occasionally be possible to avoid the use of coupling capacitors, when the dc level of the driving source is within a certain range, as shown in Figure 13. This range extends from 3.5 V to 4.5 V when using a 5 V supply, and at high basic gains, where the effect of an incorrect dc level would be most troublesome, causing an increase in noise level due to internal aspects of the input stage. For example, suppose the driver IC is an LNA having an output topology in which its load resistors are taken to the supply, and the output is buffered by emitter-followers. This presents a source for the AD8330 that could readily be directly coupled.

DC-Coupled Signal Path

In many cases, where the VGA is not required to provide its lowest noise, the full common-mode input range of zero to V_S may be used without problems, avoiding the need for any ac coupling means. However, such direct coupling at both the input and output will not automatically result in a fully dc-coupled signal path. The internal offset compensation loop must also be disengaged, by connecting the OFST pin to ground. Keep in mind that at the maximum basic gain of 50 dB ($\times 316$), every millivolt of offset at the input, arising from whatever source, causes an output offset of 316 mV, which is an appreciable fraction of the peak output swing.

Since the offset correction loop is placed after the front-end variable-gain sections of the AD8330, the most effective way of dealing with such offsets is at the input pins, as shown in Figure 15. For example, assume, for illustrative purposes, that the resistances associated with each side of the source in a certain application are 50 Ω . If this source has a very low (op amp) output impedance, the extra resistors should be inserted, with a negligible noise penalty and an attenuation of only 0.83 dB. The resistor values shown provide a trim range of about ± 2 mV.

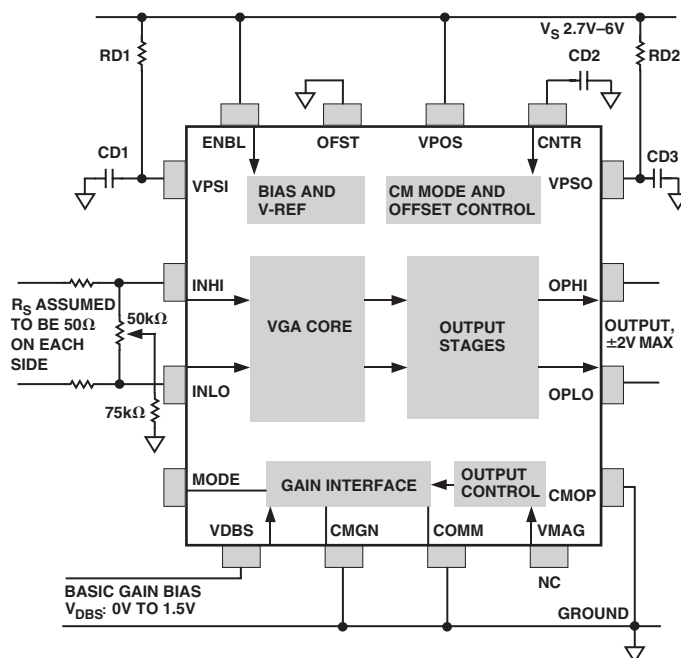

Figure 15. Input Offset Nulling in a DC-Coupled System

AD8330

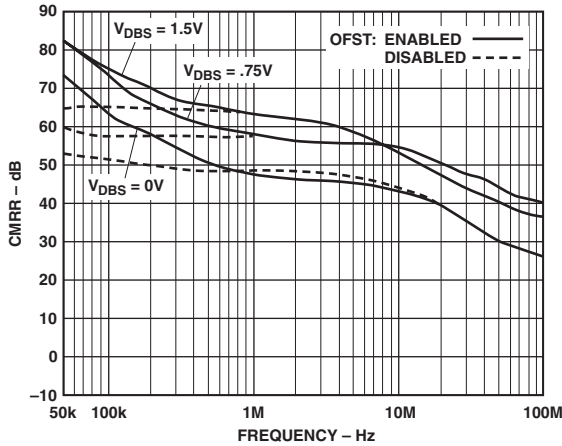

Figure 16. Input CMRR vs. Frequency for Various Values of V_{DBS}

Using Single-Sided Sources and Loads

Where the source provides a single-sided output, either INHI or INLO may be used for the input, with of course a polarity change when using INLO. The unused pin must be connected either through a capacitor to ground, or a dc bias point that corresponds closely to the dc level on the active signal pin. The input CMRR over the full frequency range is illustrated in Figure 16. In some cases, an additional element such as a SAW filter (having a single-sided-balanced configuration) or a flux-coupled transformer may be interposed. Where this element must be terminated in the correct impedance, other than 1 k Ω , it will be necessary to add either shunt or series resistors at this interface.

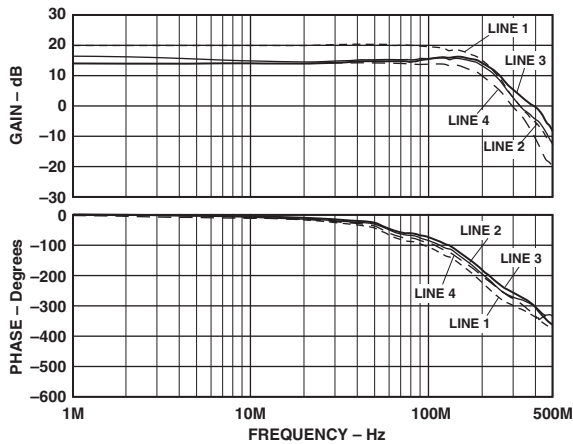

Figure 17. AC Gain and Phase for Various Loading Conditions

When driving a single-sided load, either OPHI or OPLO may be used. These outputs are very symmetric, so the only effect of this choice is to select the desired polarity. However, when the frequency range of interest extends to the upper limits of the AD8330, a dummy resistor of the same value should be attached to the unused output. Figure 17 illustrates the ac gain and phase response for various loads and $V_{DBS} = 0.75$ V. Line 1 shows the unloaded ($C_L = 12$ pF) case for reference; the gain is 6 dB lower (20 dB) using just the single-sided output. Adding a 75 Ω load just from OPHI to an ac ground results in Line 2. The gain is now a factor of $\times 1.5$ or 3.54 dB lower, but artifacts of the output common-mode control loop now appear in both the magnitude and phase response.

Adding a dummy 75 Ω to OPLO results in Line 3: the gain is a further 2.5 dB lower, at about 14 dB. The CM artifacts are no longer present but there is now a small amount of peaking. If objectionable, this may be eliminated by raising both of the capacitors on the output pins to 25 pF, as shown in Line 4.

The gain reduction incurred both by using only one output and by the additional effect of loading can be overcome by taking advantage of the V_{MAG} feature, provided primarily for just such circumstances. Thus, to restore the basic gain in the first case (Line 1), a 1 V source should be applied to this pin; to restore the gain in the second case, this voltage should be raised by a factor of $\times 1.5$, to 1.5 V. In cases 3 and 4, a further factor of $\times 1.33$ is needed to make up the 2.5 dB loss, that is, V_{MAG} should be raised to 2 V. With the restoration of gain, the peak output swing at the load is likewise restored to ± 2 V.

Pulse Operation

When using the AD8330 in applications where its transient response is of greater interest and the outputs are conveyed to their load via coaxial cables, the added capacitances may be slightly different in value, and may be placed either at the sending or load end of the cables, or divided between these nodes. Figure 18 shows an illustrative example in which dual 1 meter 75 Ω cables are driven through dc-blocking capacitors and independently terminated at ground level.

Because of the considerable variation between applications, only general recommendations can be made with regard to minimizing pulse overshoot and droop. The former can be optimized by adding small load capacitances, if necessary; the latter require the use of sufficiently large capacitors C1.

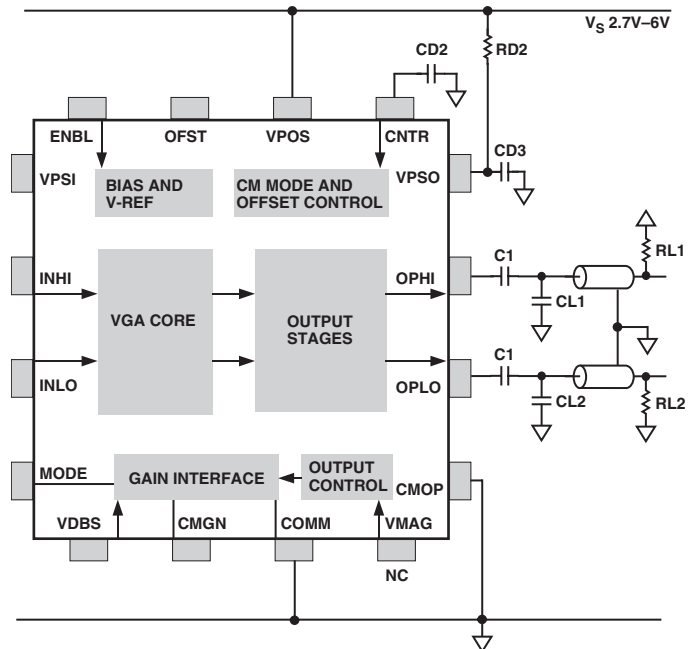

Figure 18. Driving Dual Cables with Grounded Loads

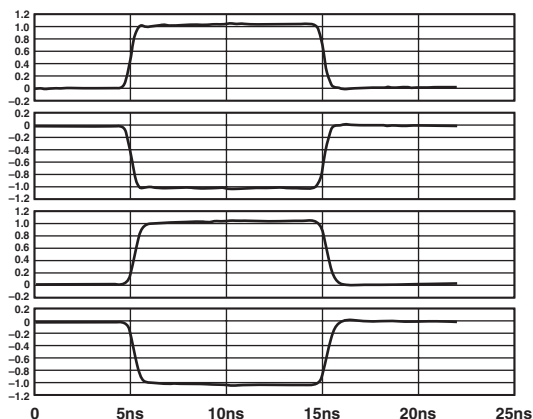

Figure 19. Typical Pulse Responses for Figure 18

Figure 19 shows typical results for $V_{DBS} = 0.24$ V, a square wave input amplitude of 450 mV (the actual combination is not important) and a rise time of 2 ns. V_{MAG} raised to 2.0 V is used. In the upper waveforms the load capacitors are both zero, and a small amount of overshoot is visible; with 40 pF the response is cleaner. A shunt capacitance of 20 pF from OPHI to OPLO will have a similar effect. Coupling capacitors for this demonstration are sufficiently large to prevent any visible droop over this time scale. The outputs at the load side will eventually assume a mean value of zero, with negative and positive excursions depending on the duty-cycle.

The bandwidth from pin VMAG to these outputs is somewhat higher than that from the normal input pins. Thus when this pin is used to rapidly modulate the primary signal, some further experimentation with response optimization may be required. In general, the AD8330 is very tolerant of a wide range of loading conditions.

Preserving Absolute Gain

Although the AD8330 is not laser-trimmed, its absolute gain calibration, being based mainly on ratios, is very good. Full details can be found in the Specifications and in the typical performance curves. Nevertheless, having finite input and output impedances, the gain is necessarily dependent on the source and load conditions. The loss incurred when either of these is finite causes an error in the absolute gain, which may also be uncertain due to the approximately $\pm 20\%$ tolerance in the absolute value of the input and output impedances.

Often, such losses and uncertainties can be tolerated and accommodated by a correction to the gain control bias. On the other hand, the error in the loss can be essentially nulled by using appropriate modifications to either the source impedance (R_S) or the load impedance (R_L), or both, in some cases by padding them with series or shunt components.

The formulation for this correction technique was described previously. However, to simplify its use, Table I is provided, showing spot values for combinations of R_S and R_L resulting in an overall loss that will not be dependent on sample-to-sample variations in on-chip resistances. Furthermore, this fixed and predictable loss can be corrected by an adjustment to V_{MAG} , as indicated in Table I.

Table I. Preserving Absolute Gain

$R_S(\Omega)$	$R_L(\Omega)$	Uncorrected Loss V_{MAG} Required		
		Factor	dB	to Correct Loss
10	15k	0.980	0.17	0.510
15	10k	0.971	0.26	0.515
20	7.5k	0.961	0.34	0.520
30	5.0k	0.943	0.51	0.530
50	3.0k	0.907	0.85	0.551
75	2.0k	0.865	1.26	0.578
100	1.5k	0.826	1.66	0.605
150	1.0k	0.756	2.43	0.661
200	750	0.694	3.17	0.720
300	500	0.592	4.56	0.845
500	300	0.444	7.04	1.125
750	200	0.327	9.72	1.531
1k	150	0.250	12.0	2.000
1.5k	100	0.160	15.9	3.125
2k	75	0.111	19.1	4.500

Calculation of Noise Figure

The AD8330 noise is a consequence of its intrinsic voltage-noise-spectral-density (E_{NSD}) and the current-noise-spectral-density (I_{NSD}). Their combined effect generates a net input noise, V_{NOISE_IN} , which is a function of the device's input resistance, R_I , nominally 1 k Ω , and the differential source resistance, R_S , as follows:

$$V_{NOISE_IN} = \sqrt{\left\{ E_{NSD}^2 + I_{NSD}^2 (R_I + R_S)^2 \right\}} \quad (16)$$

Note that we assume purely resistive source and input impedances as a concession to simplicity. A more thorough treatment of noise mechanisms, for the case where the source is reactive, is beyond the scope of these brief notes. Also note that V_{NOISE_IN} is the voltage-noise-spectral-density appearing across the differential input pins, INHI, INLO. In preparing for the calculation of noise figure, we will define V_{SIG} as the open-circuit signal voltage across the source and V_{IN} as the differential input to the AD8330. The relationship is simply

$$V_{IN} = \frac{V_{SIG} R_I}{(R_I + R_S)} \quad (17)$$

At maximum gain, E_{NSD} is 4.1 nV/ \sqrt{Hz} , and I_{NSD} is 3 pA/ \sqrt{Hz} . Thus, the short-circuit voltage noise is:

$$\begin{aligned} V_{NOISE_IN} &= \sqrt{\left\{ \left(4.1 \text{ nV} / \sqrt{\text{Hz}} \right)^2 + \left(3 \text{ pA} / \sqrt{\text{Hz}} \right)^2 (1 \text{ k}\Omega + 0)^2 \right\}} \\ &= 5.08 \text{ nV} / \sqrt{\text{Hz}} \end{aligned} \quad (18)$$

Next, examine the net noise when $R_S = R_I = 1$ k Ω , often incorrectly called the “matching” condition, rather than “source impedance termination,” which is the actual situation in this case. Repeating the procedure:

$$\begin{aligned} V_{NOISE_IN} &= \sqrt{\left\{ \left(4.1 \text{ nV} / \sqrt{\text{Hz}} \right)^2 + \left(3 \text{ pA} / \sqrt{\text{Hz}} \right)^2 (1 \text{ k}\Omega + 1 \text{ k}\Omega)^2 \right\}} \\ &\approx 7.3 \text{ nV} / \sqrt{\text{Hz}} \end{aligned} \quad (19)$$

AD8330

The noise figure is just the decibel representation of the noise factor, N_{FAC} , which is commonly defined as follows:

$$N_{FAC} = \frac{\text{Signal-to-noise ratio at input}}{\text{Signal-to-noise ratio at output}} \quad (20)$$

However, this is equivalent to

$$N_{FAC} = \frac{\text{Signal-to-noise ratio at the source}}{\text{Signal-to-noise ratio at the input pins}} \quad (21)$$

Let V_{NSD} be the voltage-noise-spectral-density $\sqrt{kTR_S}$ due to the source resistance. Then we have:

$$N_{FAC} = \frac{V_{SIG} \{R_I / (R_I + R_S)\} / V_{NSD}}{V_{IN} / \{V_{NOISE_IN} R_S / (R_I + R_S)\}} = \frac{R_I V_{NOISE_IN}}{R_S V_{NSD}} \quad (22)$$

using (17). Thus, using the result (19) for a source resistance of 1 k Ω , having a noise-spectral density of 4.08 nV/ $\sqrt{\text{Hz}}$, we have:

$$N_{FAC} = \frac{(1 \text{ k}\Omega)(7.3 \text{ nV} / \sqrt{\text{Hz}})}{(1 \text{ k}\Omega)(4.08 \text{ nV} / \sqrt{\text{Hz}})} = 1.79 \quad (23)$$

Finally, converting this to decibels using:

$$N_{FIG} = 10 \log_{10} (N_{FAC}) \quad (24)$$

we find the noise figure in this case to be 5.06 dB, which is somewhat lower than the value shown in Figure 10 for this operating condition.

Noise as a Function of V_{DBS}

The chief consequence of lowering the basic gain using V_{DBS} is that the current-noise-spectral-density I_{NSD} increases with the square root of the basic gain magnitude, G_{BN} :

$$I_{NSD} = 3 \text{ pA} / \sqrt{\text{Hz}} \sqrt{G_{BN}} \quad (25)$$

Thus, at the maximum basic gain of $\times 316$, I_{NSD} has risen to 53.3 pA/ $\sqrt{\text{Hz}}$, and if we recalculate the noise figure using the procedures just explained, we find it has risen to 17.2 dB.

Distortion Considerations

Continuously variable-gain amplifiers invariably employ nonlinear circuit elements; consequently it is common for their distortion to be higher than well-designed fixed-gain amplifiers. The translinear multiplier principles used in the AD8330 in principle yield extremely low distortion, a result of the fundamental linearization technique that is an inherent aspect of these circuits.

In practice, however, the effect of device mismatches and junction resistances in the core cell, and other mechanisms in its supporting circuitry inevitably cause distortion, further aggravated by other effects in the later output stages. Some of these effects are very consistent from one sample to the next, while those due to mismatches (causing predominantly even-order distortion components) will be quite variable. Where the highest linearity (and also lowest noise) is demanded, consider using one of the X-AMP products such as the AD603 (single-channel), AD604 (dual-channel), or AD8332 (wideband dual-channel with ultra-low noise LNAs).

P1 dB and V1 dB

In addition to the nonlinearities that arise within the core of the AD8330, at moderate output levels, a further metric that is more commonly stated for RF components that deliver appreciable power to a load is the “1 dB compression point.” This is defined in a very specific manner: it is that point at which, with increasing output level, the power delivered to the load eventually falls to a value that is 1 dB lower than it would be for a perfectly linear system. (While this metric is sometimes called the “1 dB gain-compression point,” it is important to note that this is not the output level at which the incremental gain has fallen by 1 dB).

As was shown in Figure 6, the output of the AD8330 limits quite abruptly, and the gain drops sharply above the clipping level. The output power, on the other hand, using an external resistive load, R_L , continues to increase. In the most extreme case, the waveform changes from the sinusoidal form of the test signal, with an amplitude just below the clipping level, say, V_{CLIP} , to a squarewave of precisely the same amplitude. The change in power over this range is from $(V_{CLIP}/\sqrt{2})^2/R_L$ to V_{CLIP}^2/R_L , that is, a factor of 2, or 3 dB in power terms. It can be shown that for an ideal limiting amplifier, the 1 dB compression point occurs for an overdrive factor of 2 dB.

For example, if the AD8330 is driving a 150 Ω load and V_{MAG} has been set to 2 V, the peak output is nominally ± 4 V (as noted above, the actual value when loaded may differ due to the mismatch between on-chip and external resistors), or 2.83 V rms for a sine wave output, which corresponds to a power of 53.3 mW, that is, 17.3 dBm in 150 Ω . Thus, the P1dB level, at 2 dB above clipping, is 19.3 dBm.

While not involving power transfer, it is sometimes useful to state the V1dB, which is the output voltage (unloaded or loaded) that is 2 dB above clipping for a sine waveform. In the above example, this voltage is still 2.83 V rms, which can be expressed as 9.04 dBV (0 dBV corresponds to a 1 V sine wave). Thus the V1dB is at 11.04 dBV.

APPLICATIONS

The AD8330’s versatility, very constant ac response over a wide range of gains, large signal dynamic range, output swing, single-supply operation, and low power consumption will commend this VGA to a diverse variety of applications. Only a few can be described here, including the most basic uses and some unusual ones.

ADC Driving

The AD8330 is well-suited to driving a high speed converter. There are now many available, but to illustrate the general features we will use one of the least expensive, the AD9214, which is available in three grades for operation at 65 MHz, 80 MHz, and 105 MHz; the AD9214BRS-80 is a good complement to the general capabilities of this VGA.

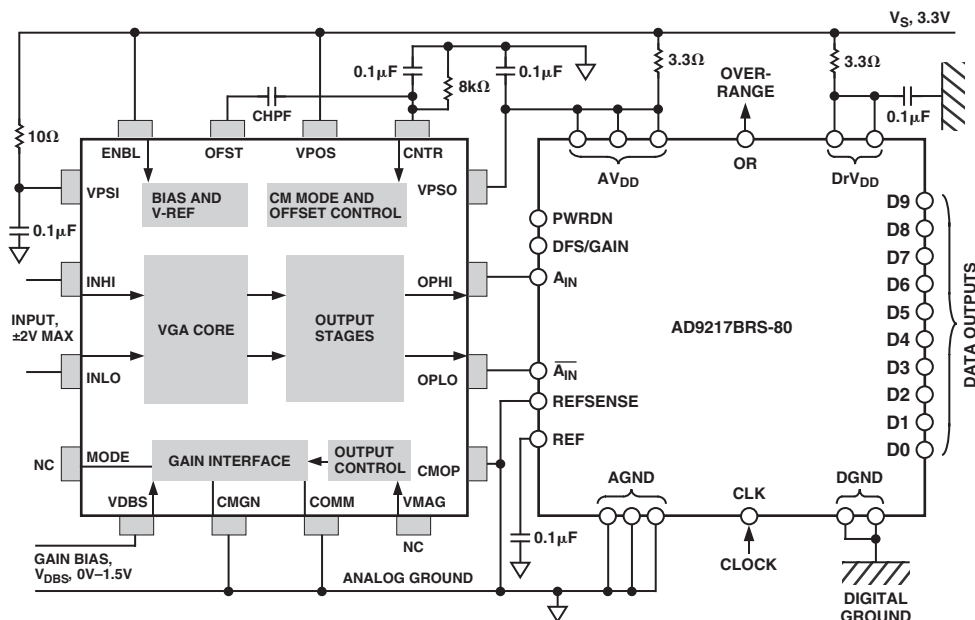

Figure 20. Driving an Analog-to-Digital Converter (Preliminary)

Figure 20 shows the connections. A 3.3 V supply is used for both parts. The ADC requires that its input pins be positioned at one third of the supply, or 1.1 V. Since the default output level of the VGA is one half the supply or 1.65 V, a small correction is introduced by the 8 kΩ resistor from CNTR to ground. The ADC specifications require that the common-mode input be within ±0.2 V of the nominal 1.1 V; variations of up to ±20% in the AD8330's on-chip resistors will change this voltage by only ±70 mV. With the connections shown, the AD9214 is able to receive an input of 2 V p-p; the peak output of the AD8330 can be reduced if desired by adding a resistor from VMAG to ground. An overrange condition is signaled by a HI state on pin OR of the AD9214. DFS/GAIN is unconnected in this example; this produces an offset-binary output. To provide a twos complement output, it should be connected to the REF pin.

For ADCs running at sampling rates substantially below the bandwidth of the AD8330, an intervening noise filter is recommended to limit the noise bandwidth. A one-pole filter can easily be created with a single differential capacitor between OPHI and OPLO outputs. For a corner frequency of f_c , the capacitor should have a value of

$$C_{FILT} = 1 / 942 f_c \quad (26)$$

For example a 10 MHz corner requires about 100 pF.

Simple AGC Amplifier

Figure 21 illustrates the use of the inverted gain mode and the offset gain range ($0.2 \text{ V} < V_{DBS} < 1.7 \text{ V}$) in supporting a low cost AGC loop. Q1 is used as a detector: when OPHI is sufficiently higher than CNTR, due to the signal swing it conducts and charges C1; this raises V_{DBS} and rapidly lowers the gain. Note that MODE is grounded (see Figure 5). The minimum voltage needed across R1 to set up the full gain is now 0.2 V, since CMGN is dc open-circuited (this does not alter V_{MAG}), while the maximum is 1.7 V.

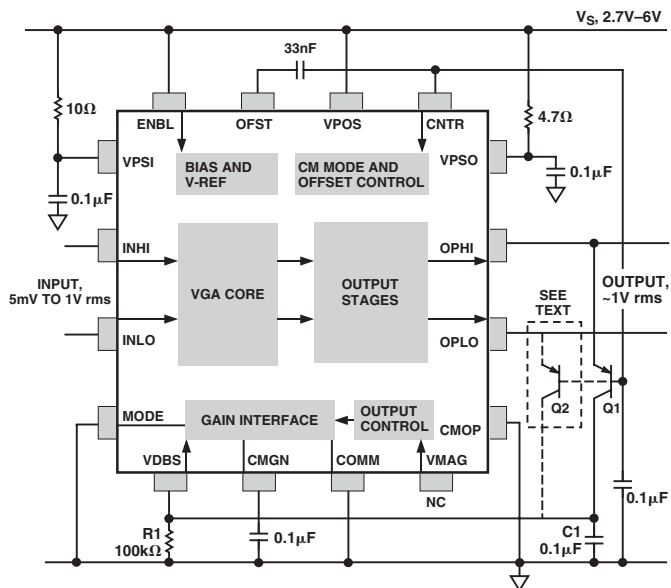

Figure 21. Simple AGC Amplifier (Preliminary)

When the loop is settled, the average current in Q1 is $V_{DBS}/R1$, which varies from 2 μA at maximum gain ($V_{DBS} = 0.2 \text{ V}$) to 17 μA at minimum gain ($V_{DBS} = 1.7 \text{ V}$). This change in Q1's current causes an increase of ~0.25 dB over the full gain range in the differential output of nominally 0.75 dBV at midrange (3.08 V p-p), corresponding to a 200:1 compression ratio. This is plotted in Figure 22 for a representative 100 kHz input.

AD8330

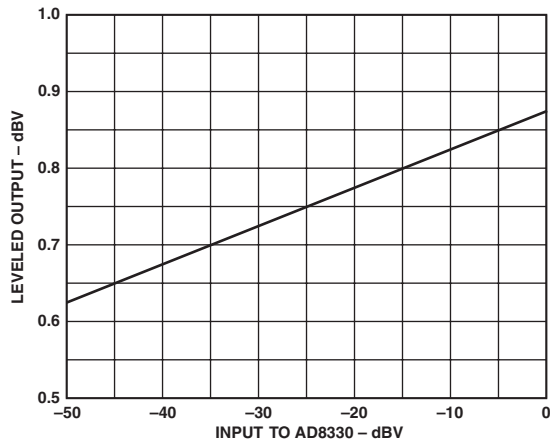

Figure 22. AGC Output vs. Input Amplitude (Simulation)

The upper panel in Figure 23 shows time-domain output for 14 3 dB steps in input amplitude from 5.4 mV to 1.7 V. The waveforms in Figure 22 show the AGC voltage V_{DBS} .

This simple detector exhibits a temperature variation in the differential output amplitude of about 4 mV/°C. It provides a fast attack time (an increase in the input is quickly leveled to the nominal output, due to the high peak currents in Q1) and a slow release time (a decrease in the input is not restored as quickly). The voltage at the VDBS pin may be used as an RSSI output, scaled 30 mV/dB. Note that the attack time can be halved by adding a second transistor as shown in the box (Figure 21). For operation at lower frequencies, the AGC hold capacitor must be increased.

Wide Range True RMS Voltmeter

The AD8362 is an rms-responding detector providing a dynamic range of 60 dB from low frequencies to 2.7 GHz. This may be increased to 110 dB using an AD8330 as a preconditioner, provided the noise bandwidth is limited by an interstage low-pass or band-pass filter.

The VGA also provides an input port that is easier to drive than the 200 Ω input of the AD8362. Figure 24 shows the general scheme.

Both the AD8330 and AD8362 provide linear-in-decibel control interfaces. Thus when the output of the latter is used to control the gain of the former, this functional form is unaffected. The overall scaling is 33 mV/dB. Figure 25 shows the time domain response using a loop filter capacitor of 10 nF, for inputs ranging from 10 μV to 1 V rms, that is, a 100 dB measurement range.

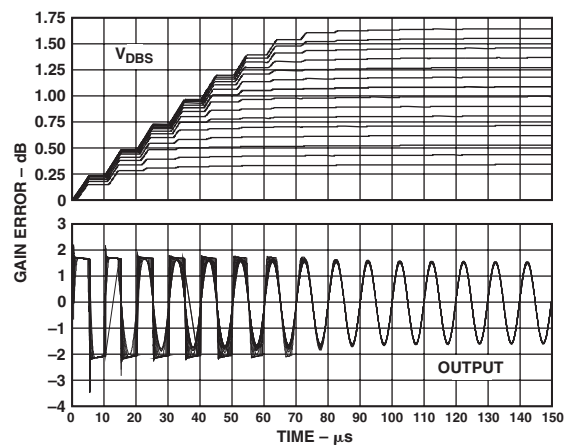

Figure 23. Time Domain Waveforms (Simulation) (See Text)

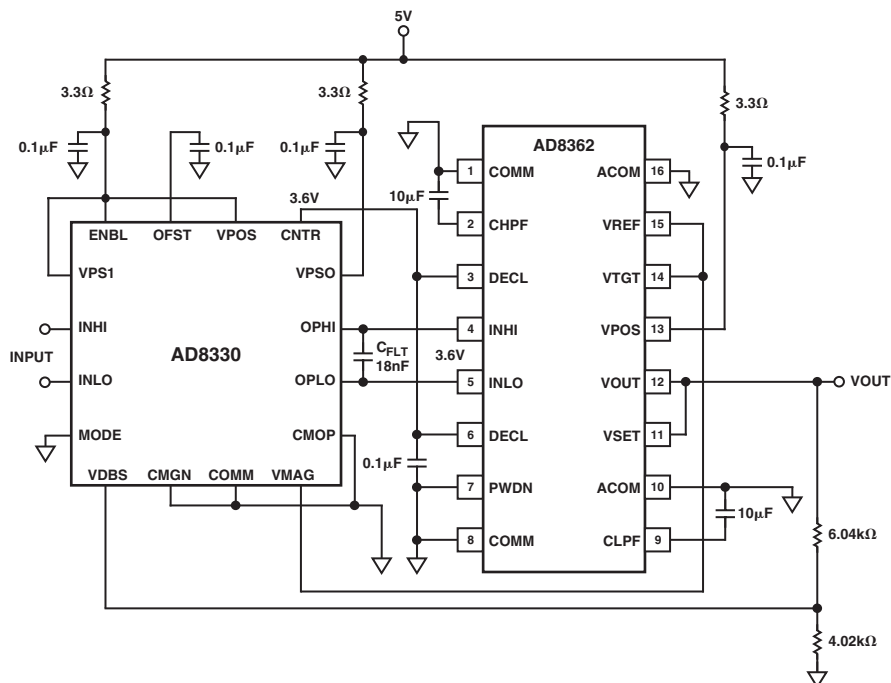

Figure 24. Wide Range True RMS Voltmeter (Preliminary)

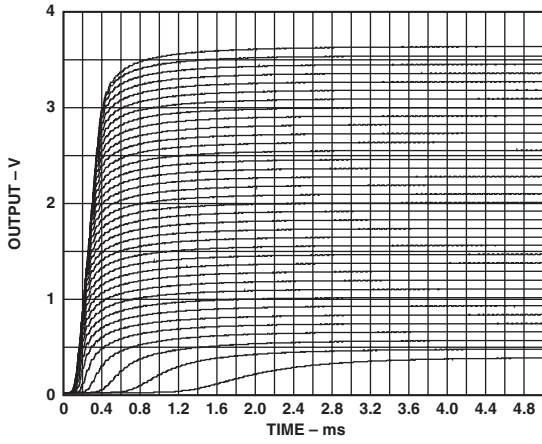
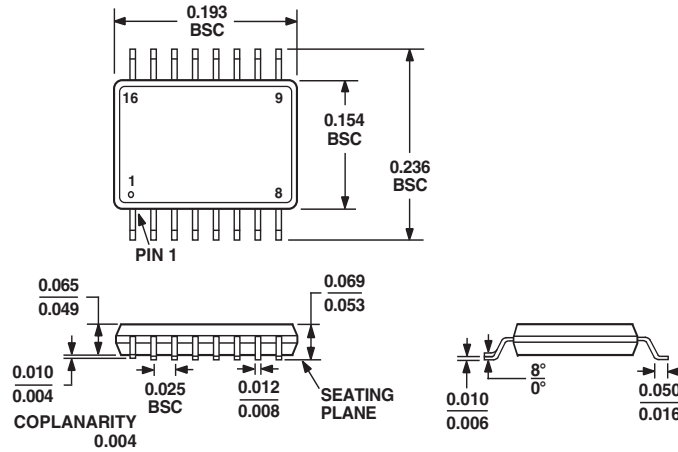

Figure 25. Time Domain Response of RMS Voltmeter (Simulation)

OUTLINE DIMENSIONS

16-Lead Shrink Small Outline Package [QSOP]
(RQ-16)

Dimensions shown in inches



COMPLIANT TO JEDEC STANDARDS MO-137AB

16-Lead Lead Frame Chip Scale Package [LFCSP]
3 mm × 3 mm Body
(CP-16)

Dimensions shown in millimeters

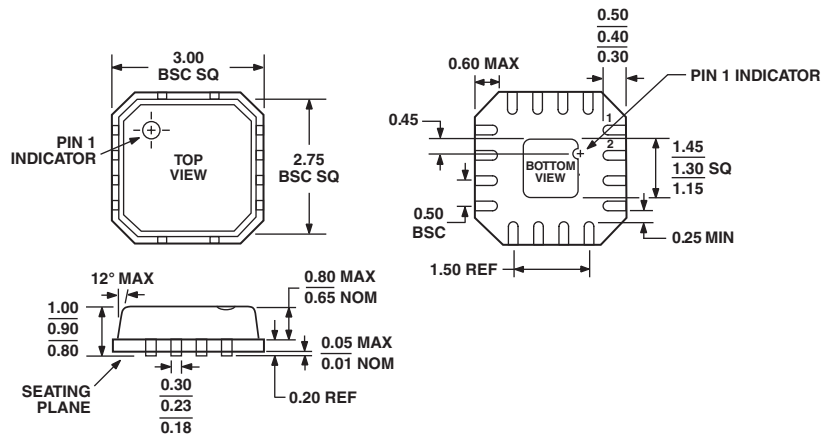

COMPLIANT TO JEDEC STANDARDS MO-220-VEED-2

Revision History

Location	Page
4/03—Data Sheet changed from REV. 0 to REV. A.	
Update OUTLINE DIMENSIONS	26

