



8-BIT SHIFT/STORAGE REGISTER WITH 3-STATE OUTPUTS

The SN54/74LS323 is an 8-Bit Universal Shift/Storage Register with 3-state outputs. Its function is similar to the SN54/74LS299 with the exception of Synchronous Reset. Parallel load inputs and flip-flop outputs are multiplexed to minimize pin count. Separate inputs and outputs are provided for flip-flops Q₀ and Q₇ to allow easy cascading.

Four operation modes are possible: hold (store), shift left, shift right, and parallel load. All modes are activated on the LOW-to-HIGH transition of the Clock.

- Common I/O for Reduced Pin Count
- Four Operation Modes: Shift Left, Shift Right, Parallel Load and Store
- Separate Continuous Inputs and Outputs from Q₀ and Q₇ Allow Easy Cascading
- Fully Synchronous Reset
- 3-State Outputs for Bus Oriented Applications
- Input Clamp Diodes Limit High-Speed Termination Effects
- ESD > 3500 Volts

CONNECTION DIAGRAM DIP (TOP VIEW)

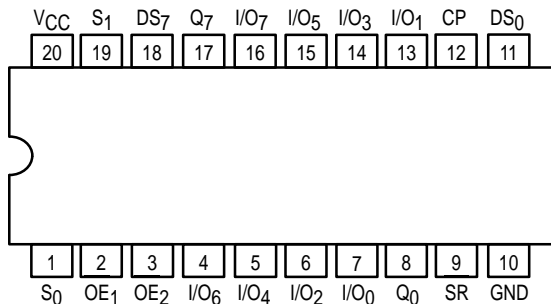

NOTE:
The Flatpak version has the same pinouts (Connection Diagram) as the Dual In-Line Package.

SN54/74LS323

8-BIT SHIFT/STORAGE REGISTER WITH 3-STATE OUTPUTS

LOW POWER SCHOTTKY

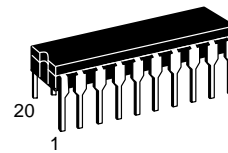

J SUFFIX
CERAMIC
CASE 732-03

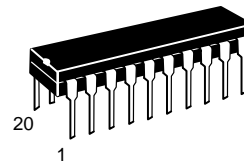

N SUFFIX
PLASTIC
CASE 738-03

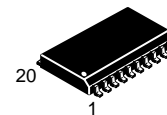

DW SUFFIX
SOIC
CASE 751D-03

ORDERING INFORMATION

SN54LSXXXJ Ceramic
SN74LSXXXN Plastic
SN74LSXXXDW SOIC

PIN NAMES

CP	Clock Pulse (active positive going edge) Input
DS ₀	Serial Data Input for Right Shift
DS ₇	Serial Data Input for Left Shift
I/O _n	Parallel Data Input or Parallel Output (3-State) (Note c)
OE ₁ , OE ₂	3-State Output Enable (active LOW) Inputs
Q ₀ , Q ₇	Serial Outputs (Note b)
S ₀ , S ₁	Mode Select Inputs
SR	Synchronous Reset (active LOW) Input

NOTES:

- 1 TTL LOAD = 40 μA HIGH/1.6 mA LOW.
- The output LOW drive factor is 2.5 U.L. for Military (54) and 5 U.L. for Commercial Temperature Ranges.
- The output LOW drive factor is 7.5 U.L. for Military (54) and 15 U.L. for Commercial Temperature Ranges. The output HIGH drive factor is 25 U.L. for Military (54) and 65 U.L. for Commercial Temperature Ranges.

LOADING (Note a)

HIGH	LOW
0.5 U.L.	0.25 U.L.
0.5 U.L.	0.25 U.L.
0.5 U.L.	0.25 U.L.
1.0 U.L.	0.5 U.L.
65 (25) U.L.	15 (7.5) U.L.
0.5 U.L.	0.25 U.L.
10 U.L.	5 (2.5) U.L.
1 U.L.	
0.5 U.L.	0.25 U.L.

SN54/74LS323

LOGIC DIAGRAM

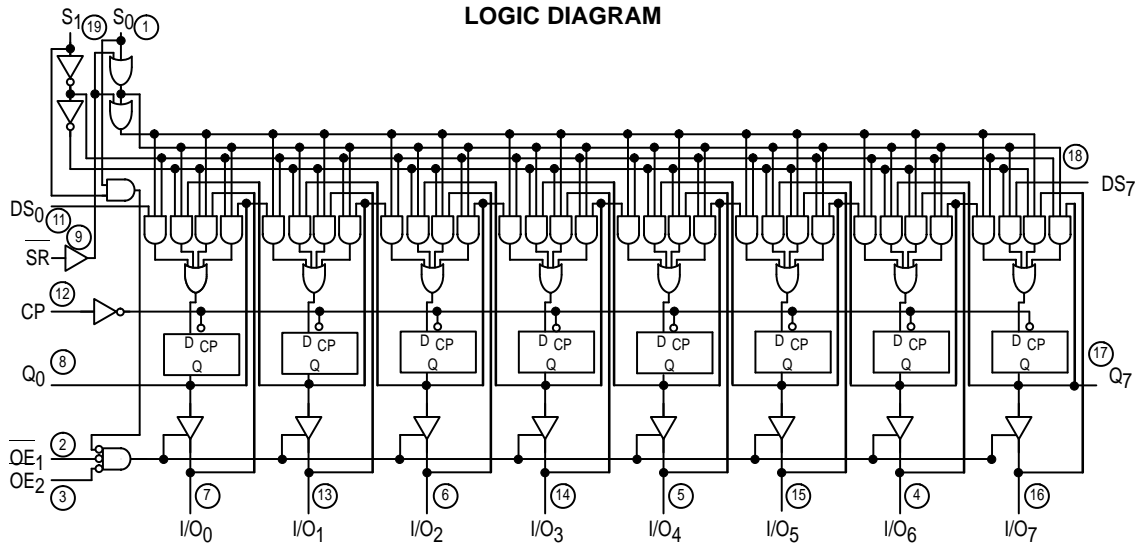

FUNCTIONAL DESCRIPTION

The logic diagram and truth table indicate the functional characteristics of the SN54/74LS323 Universal Shift/Storage Register. This device is similar in operation to the SN54/74LS299 except for synchronous reset. A partial list of the common features are described below:

1. They use eight D-type edge-triggered flip-flops that respond only to the LOW-to-HIGH transition of the Clock (CP). The only timing restriction, therefore, is that the mode control (S_0 , S_1) and data inputs (DS_0 , DS_7 , I/O_0 – I/O_7) may be stable at least a setup time prior to the positive transition of the Clock Pulse.
2. When $S_0 = S_1 = 1$, I/O_0 – I/O_7 are parallel inputs to flip-flops Q_0 – Q_7 respectively, and the outputs of Q_0 – Q_7 are in the high impedance state regardless of the state of OE_1 or OE_2 .

An important unique feature of the SN54/74LS323 is a fully Synchronous Reset that requires only to be stable at least one setup time prior to the positive transition of the Clock Pulse.

TRUTH TABLE

INPUTS								RESPONSE
SR	S_1	S_0	OE_1	OE_2	CP	DS_0	DS_7	
L	X	X	H	X	⌋	X	X	Synchronous Reset; $Q_0 = Q_7 = \text{LOW}$ I/O voltage undetermined
L	X	X	X	H	⌋	X	X	
L	H	H	X	X	⌋	X	X	
L	L	X	L	L	⌋	X	X	Synchronous Reset; $Q_0 = Q_7 = \text{LOW}$ I/O voltage LOW
L	X	L	L	L	⌋	X	X	
H	L	H	X	X	⌋	D	X	Shift Right; D Q_0 ; Q_0 Q_1 ; etc. Shift Right; D Q_0 & I/O_0 ; Q_0 Q_1 & I/O_1 ; etc.
H	L	H	L	L	⌋	D	X	
H	H	L	X	X	⌋	X	D	Shift Left; D Q_7 ; Q_7 Q_6 ; etc. Shift Left; D Q_7 & I/O_7 ; Q_7 Q_6 & I/O_6 ; etc.
H	H	L	L	L	⌋	X	D	
H	H	H	X	X	⌋	X	X	Parallel Load I/O_n Q_n
H	L	L	H	X	X	X	X	Hold; I/O Voltage Undetermined
H	L	L	X	H	X	X	X	
H	L	L	L	L	X	X	X	Hold; $I/O_n = Q_n$

H = HIGH Voltage Level
L = LOW Voltage Level
X = Immaterial

SN54/74LS323

GUARANTEED OPERATING RANGES

Symbol	Parameter		Min	Typ	Max	Unit
V _{CC}	Supply Voltage		4.5 4.75	5.0 5.0	5.5 5.25	V
T _A	Operating Ambient Temperature Range		-55 0	25 25	125 70	°C
I _{OH}	Output Current — High	Q ₀ , Q ₇	54, 74		-0.4	mA
I _{OL}	Output Current — Low	Q ₀ , Q ₇ Q ₀ , Q ₇	54 74		4.0 8.0	mA
I _{OH}	Output Current — High	I/O ₀ –I/O ₇ I/O ₀ –I/O ₇	54 74		-1.0 -2.6	mA
I _{OL}	Output Current — Low	I/O ₀ –I/O ₇ I/O ₀ –I/O ₇	54 74		12 24	mA

DC CHARACTERISTICS OVER OPERATING TEMPERATURE RANGE (unless otherwise specified)

Symbol	Parameter	Limits			Unit	Test Conditions	
		Min	Typ	Max			
V _{IH}	Input HIGH Voltage	2.0			V	Guaranteed Input HIGH Voltage for All Inputs	
V _{IL}	Input LOW Voltage	54		0.7	V	Guaranteed Input LOW Voltage for All Inputs	
		74		0.8			
V _{IK}	Input Clamp Diode Voltage		-0.65	-1.5	V	V _{CC} = MIN, I _{IN} = -18 mA	
V _{OH}	Output HIGH Voltage I/O ₀ –I/O ₇	54	2.4	3.2	V	V _{CC} = MIN, I _{OH} = MAX	
		74	2.4	3.1	V		
V _{OH}	Output HIGH Voltage Q ₀ , Q ₇	54	2.5	3.4	V	V _{CC} = MIN, I _{OH} = MAX	
		74	2.7	3.4	V		
V _{OL}	Output LOW Voltage I/O ₀ –I/O ₇	54, 74		0.25	0.4	V	I _{OL} = 12 mA V _{CC} = V _{CC} MIN, V _{IN} = V _{IL} or V _{IH} per Truth Table
		74		0.35	0.5	V	
V _{OL}	Output LOW Voltage Q ₀ –Q ₇	54, 74			0.4	V	I _{OL} = 4.0 mA V _{CC} = V _{CC} MIN, V _{IN} = V _{IL} or V _{IH} per Truth Table
		74			0.5	V	
I _{OZH}	Output Off Current HIGH I/O ₀ –I/O ₇				40	μA	V _{CC} = MAX, V _{OUT} = 2.7 V
I _{OZL}	Output Off Current LOW I/O ₀ –I/O ₇				-400	μA	V _{CC} = MAX, V _{OUT} = 0.4 V
I _{IH}	Input HIGH Current	Others			20	μA	V _{CC} = MAX, V _{IN} = 2.7 V
		S ₀ , S ₁ , I/O ₀ –I/O ₇			40	μA	
		Others			0.1	mA	V _{CC} = MAX, V _{IN} = 7.0 V
		S ₀ , S ₁ I/O ₀ –I/O ₇			0.2 0.1	mA	
I _{IL}	Input LOW Current	Others			-0.4	mA	V _{CC} = MAX, V _{IN} = 0.4 V
		S ₀ , S ₁			-0.8	mA	
I _{OS}	Short Circuit Current (Note 1)	Q ₀ , Q ₇	-20		-100	mA	V _{CC} = MAX
		I/O ₀ –I/O ₇	-30		-130	mA	V _{CC} = MAX
I _{CC}	Power Supply Current				53	mA	V _{CC} = MAX

Note 1: Not more than one output should be shorted at a time, nor for more than 1 second.

SN54/74LS323

AC CHARACTERISTICS ($T_A = 25^\circ\text{C}$, $V_{CC} = 5.0\text{ V}$)

Symbol	Parameter	Limits			Unit	Test Conditions
		Min	Typ	Max		
f_{MAX}	Maximum Clock Frequency	25	35		MHz	$C_L = 15\text{ pF}$
t_{PHL} t_{PLH}	Propagation Delay, Clock to Q_0 or Q_7		26 22	39 33	ns	
t_{PHL} t_{PLH}	Propagation Delay, Clock to I/O_0 – I/O_7		25 17	39 25	ns	$C_L = 45\text{ pF}$, $R_L = 667\ \Omega$
t_{PZH} t_{PZL}	Output Enable Time		14 20	21 30	ns	
t_{PHZ} t_{PLZ}	Output Disable Time		10 10	15 15	ns	$C_L = 5.0\text{ pF}$

AC SETUP REQUIREMENTS ($T_A = 25^\circ\text{C}$, $V_{CC} = 5.0\text{ V}$)

Symbol	Parameter	Limits			Unit	Test Conditions
		Min	Typ	Max		
t_W	Clock Pulse Width HIGH	25			ns	$V_{CC} = 5.0\text{ V}$
t_W	Clock Pulse Width LOW	15			ns	
t_W	Clear Pulse Width LOW	20			ns	
t_S	Data Setup Time	20			ns	
t_S	Select Setup Time	35			ns	
t_H	Data Hold Time	0			ns	
t_H	Select Hold Time	10			ns	
t_{rec}	Recovery Time	20			ns	

SN54/74LS323

3-STATE WAVEFORMS

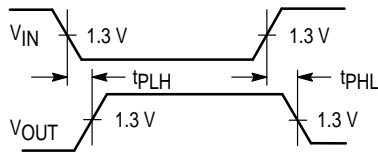

Figure 1

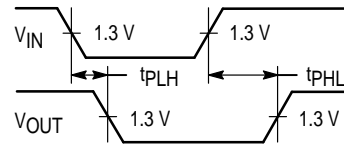

Figure 2

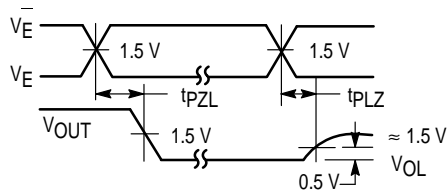

Figure 3

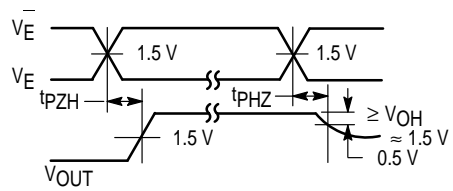
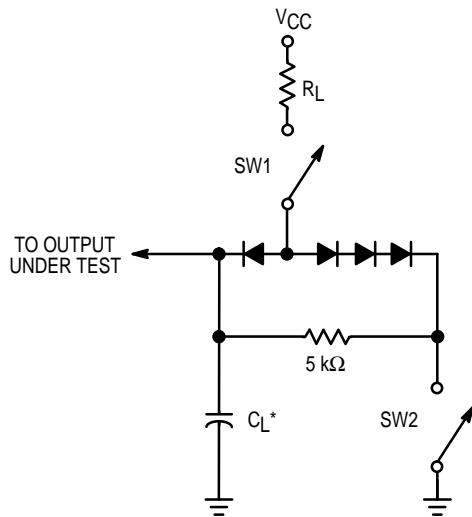

Figure 4

AC LOAD CIRCUIT



* Includes Jig and Probe Capacitance.

SWITCH POSITIONS

SYMBOL	SW1	SW2
t_{PZH}	Open	Closed
t_{PZL}	Closed	Open
t_{PLZ}	Closed	Closed
t_{PHZ}	Closed	Closed

Figure 5