

## SIPMOS<sup>®</sup> Power Transistor

- N channel
- Enhancement mode
- Avalanche-rated
- $dv/dt$  rated
- 175°C operating temperature

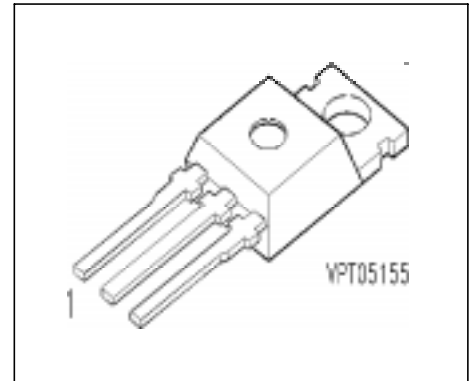

Pin 1	Pin 2	Pin 3
G	D	S

Type	$V_{DS}$	$I_D$	$R_{DS(on)}$	Package	Ordering Code
BUZ 101 S	55 V	22 A	0.06 $\Omega$	TO-220 AB	Q67040-S4013-A2

### Maximum Ratings

Parameter	Symbol	Values	Unit
Continuous drain current	$I_D$		A
$T_C = 25\text{ }^\circ\text{C}$		22	
$T_C = 100\text{ }^\circ\text{C}$		16	
Pulsed drain current	$I_{Dpuls}$		
$T_C = 25\text{ }^\circ\text{C}$		88	
Avalanche energy, single pulse	$E_{AS}$		mJ
$I_D = 22\text{ A}$ , $V_{DD} = 25\text{ V}$ , $R_{GS} = 25\text{ }^\circ\Omega$			
$L = 372\text{ }\mu\text{H}$ , $T_j = 25\text{ }^\circ\text{C}$		90	
Avalanche current, limited by $T_{jmax}$	$I_{AR}$	22	A
Avalanche energy, periodic limited by $T_{jmax}$	$E_{AR}$	5.5	mJ
Reverse diode $dv/dt$	$dv/dt$		kV/ $\mu\text{s}$
$I_S = 22\text{ A}$ , $V_{DS} = 40\text{ V}$ , $di_F/dt = 200\text{ A}/\mu\text{s}$			
$T_{jmax} = 175\text{ }^\circ\text{C}$		6	
Gate source voltage	$V_{GS}$	$\pm 20$	V
Power dissipation	$P_{tot}$		W
$T_C = 25\text{ }^\circ\text{C}$		55	

### Maximum Ratings

Parameter	Symbol	Values	Unit
Operating temperature	$T_j$	-55 ... + 175	°C
Storage temperature	$T_{stg}$	-55 ... + 175	
Thermal resistance, junction - case	$R_{thJC}$	≤ 2.7	K/W
Thermal resistance, junction - ambient	$R_{thJA}$	≤ 62	
IEC climatic category, DIN IEC 68-1		55 / 175 / 56	

### Electrical Characteristics, at $T_j = 25^\circ\text{C}$ , unless otherwise specified

Parameter	Symbol	Values			Unit
		min.	typ.	max.	

### Static Characteristics

Drain- source breakdown voltage $V_{GS} = 0 \text{ V}$ , $I_D = 0.25 \text{ mA}$ , $T_j = 25 \text{ }^\circ\text{C}$	$V_{(BR)DSS}$	55	-	-	V
Gate threshold voltage $V_{GS} = V_{DS}$ , $I_D = 40 \text{ } \mu\text{A}$	$V_{GS(th)}$	2.1	3	4	
Zero gate voltage drain current $V_{DS} = 50 \text{ V}$ , $V_{GS} = 0 \text{ V}$ , $T_j = -40 \text{ }^\circ\text{C}$ $V_{DS} = 50 \text{ V}$ , $V_{GS} = 0 \text{ V}$ , $T_j = 25 \text{ }^\circ\text{C}$ $V_{DS} = 50 \text{ V}$ , $V_{GS} = 0 \text{ V}$ , $T_j = 150 \text{ }^\circ\text{C}$	$I_{DSS}$	-	-	0.1 1 100	$\mu\text{A}$
Gate-source leakage current $V_{GS} = 20 \text{ V}$ , $V_{DS} = 0 \text{ V}$	$I_{GSS}$	-	10	100	
Drain-Source on-resistance $V_{GS} = 10 \text{ V}$ , $I_D = 16 \text{ A}$	$R_{DS(on)}$	-	0.04	0.06	

**Electrical Characteristics**, at  $T_j = 25^\circ\text{C}$ , unless otherwise specified

Parameter	Symbol	Values			Unit
		min.	typ.	max.	
<b>Dynamic Characteristics</b>					
Transconductance $V_{DS} \geq 2 \cdot I_D \cdot R_{DS(on)max}$ , $I_D = 16 \text{ A}$	$g_{fs}$	7	-	-	S
Input capacitance $V_{GS} = 0 \text{ V}$ , $V_{DS} = 25 \text{ V}$ , $f = 1 \text{ MHz}$	$C_{iss}$	-	490	615	pF
Output capacitance $V_{GS} = 0 \text{ V}$ , $V_{DS} = 25 \text{ V}$ , $f = 1 \text{ MHz}$	$C_{oss}$	-	170	215	
Reverse transfer capacitance $V_{GS} = 0 \text{ V}$ , $V_{DS} = 25 \text{ V}$ , $f = 1 \text{ MHz}$	$C_{rss}$	-	95	120	
Turn-on delay time $V_{DD} = 30 \text{ V}$ , $V_{GS} = 10 \text{ V}$ , $I_D = 22 \text{ A}$ $R_G = 19.6 \Omega$	$t_{d(on)}$	-	10	15	ns
Rise time $V_{DD} = 30 \text{ V}$ , $V_{GS} = 10 \text{ V}$ , $I_D = 22 \text{ A}$ $R_G = 19.6 \Omega$	$t_r$	-	25	38	
Turn-off delay time $V_{DD} = 30 \text{ V}$ , $V_{GS} = 10 \text{ V}$ , $I_D = 22 \text{ A}$ $R_G = 19.6 \Omega$	$t_{d(off)}$	-	20	30	
Fall time $V_{DD} = 30 \text{ V}$ , $V_{GS} = 10 \text{ V}$ , $I_D = 22 \text{ A}$ $R_G = 19.6 \Omega$	$t_f$	-	20	30	
Gate charge at threshold $V_{DD} = 40 \text{ V}$ , $I_D = 0.1 \text{ A}$ , $V_{GS} = 0 \text{ to } 1 \text{ V}$	$Q_{g(th)}$	-	0.5	0.75	nC
Gate charge at 7.0 V $V_{DD} = 40 \text{ V}$ , $I_D = 22 \text{ A}$ , $V_{GS} = 0 \text{ to } 7 \text{ V}$	$Q_{g(7)}$	-	13	20	
Gate charge total $V_{DD} = 40 \text{ V}$ , $I_D = 22 \text{ A}$ , $V_{GS} = 0 \text{ to } 10 \text{ V}$	$Q_{g(total)}$	-	17	26	
Gate plateau voltage $V_{DD} = 40 \text{ V}$ , $I_D = 22 \text{ A}$	$V_{(plateau)}$	-	5.9	-	V

**Electrical Characteristics**, at  $T_j = 25^\circ\text{C}$ , unless otherwise specified

Parameter	Symbol	Values			Unit
		min.	typ.	max.	
<b>Reverse Diode</b>					
Inverse diode continuous forward current $T_C = 25^\circ\text{C}$	$I_S$	-	-	22	A
Inverse diode direct current, pulsed $T_C = 25^\circ\text{C}$	$I_{SM}$	-	-	88	
Inverse diode forward voltage $V_{GS} = 0\text{ V}, I_F = 44\text{ A}$	$V_{SD}$	-	1.2	1.8	V
Reverse recovery time $V_R = 30\text{ V}, I_F = I_S, di_F/dt = 100\text{ A}/\mu\text{s}$	$t_{rr}$	-	55	85	ns
Reverse recovery charge $V_R = 30\text{ V}, I_F = I_S, di_F/dt = 100\text{ A}/\mu\text{s}$	$Q_{rr}$	-	0.12	0.18	$\mu\text{C}$

### Power dissipation

$$P_{\text{tot}} = f(T_C)$$

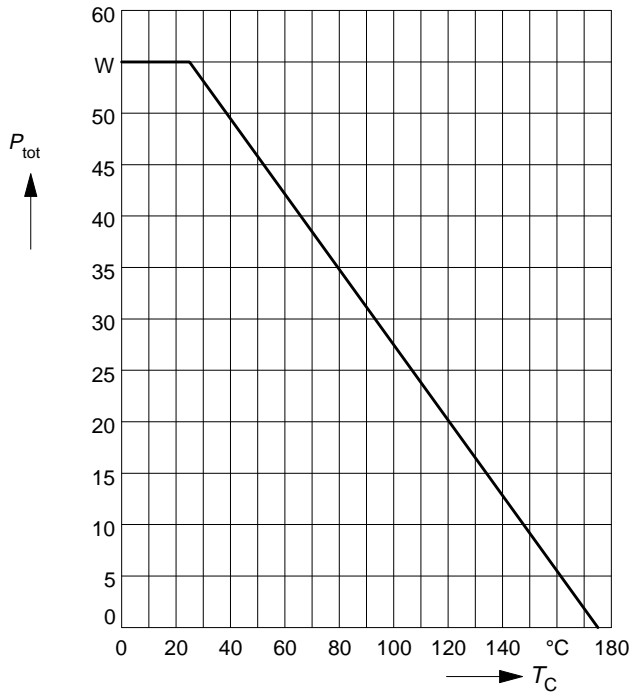

### Drain current

$$I_D = f(T_C)$$

parameter:  $V_{\text{GS}} \geq 10 \text{ V}$

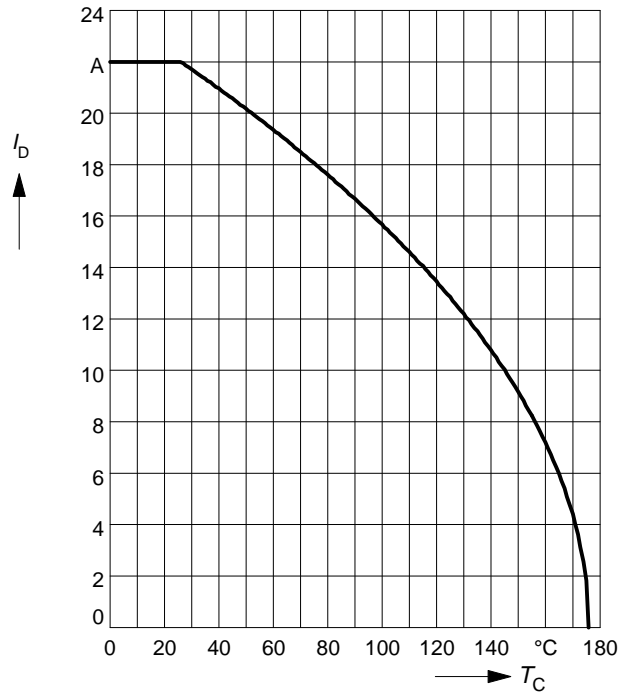

### Typ. output characteristics

$$I_D = f(V_{DS})$$

parameter:  $t_p = 80 \mu s$

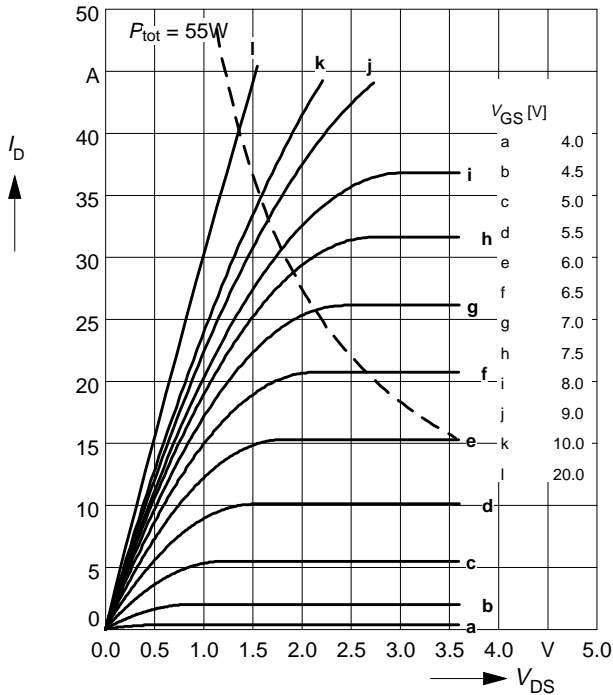

### Typ. drain-source on-resistance

$$R_{DS(on)} = f(I_D)$$

parameter:  $t_p = 80 \mu s, T_j = 25^\circ C$

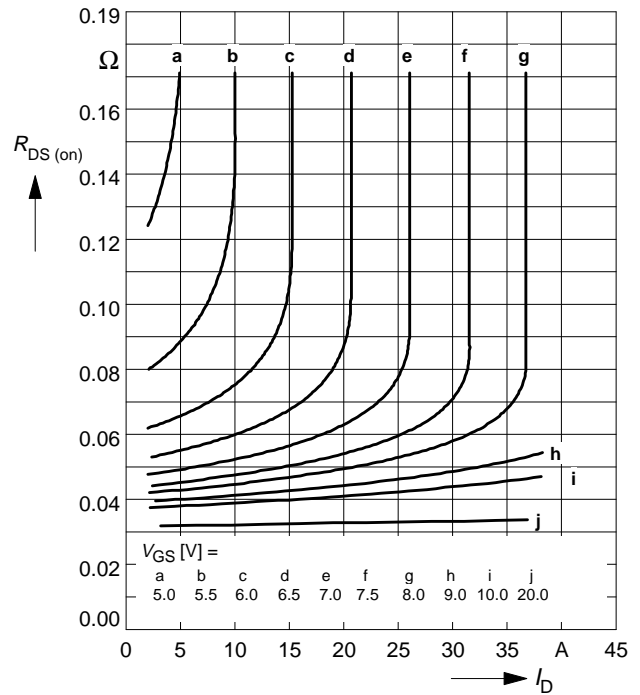

### Typ. transfer characteristics $I_D = f(V_{GS})$

parameter:  $t_p = 80 \mu s$

$$V_{DS} \geq 2 \times I_D \times R_{DS(on)max}$$

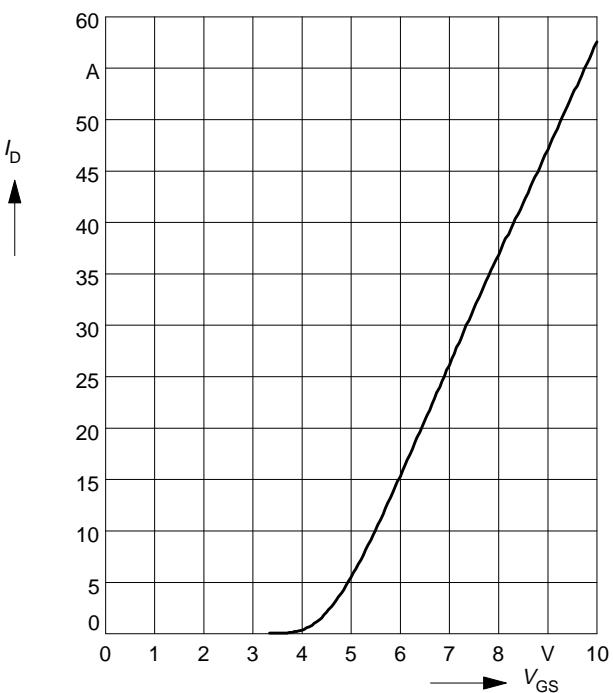

### Drain-source on-resistance

$$R_{DS(on)} = f(T_j)$$

parameter:  $I_D = 16\text{ A}$ ,  $V_{GS} = 10\text{ V}$

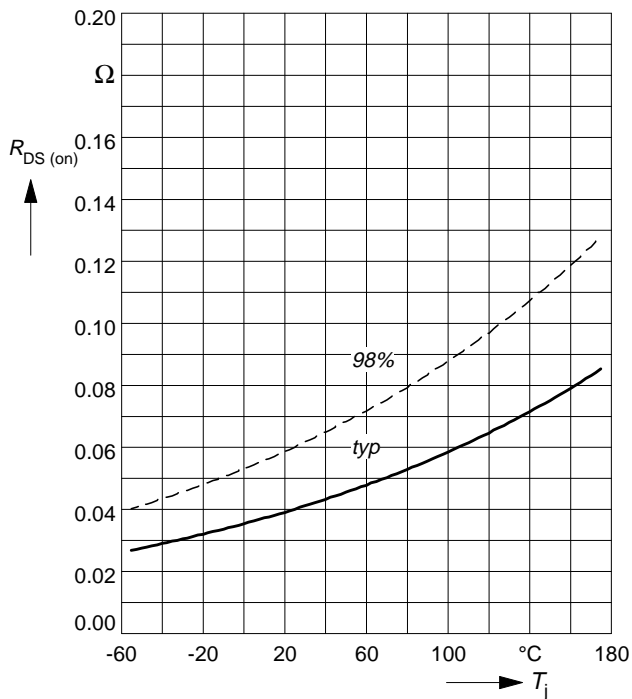

### Gate threshold voltage

$$V_{GS(th)} = f(T_j)$$

parameter:  $V_{GS} = V_{DS}$ ,  $I_D = 40\text{ }\mu\text{A}$

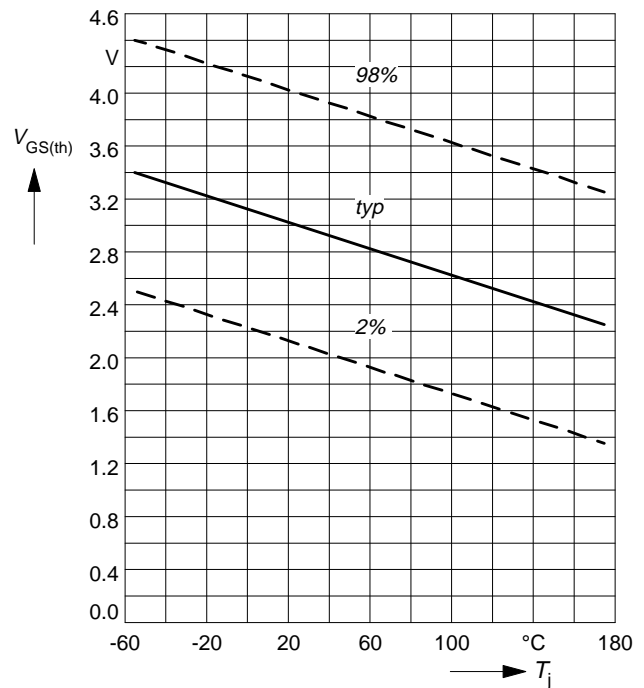

### Typ. capacitances

$$C = f(V_{DS})$$

parameter:  $V_{GS} = 0\text{ V}$ ,  $f = 1\text{ MHz}$

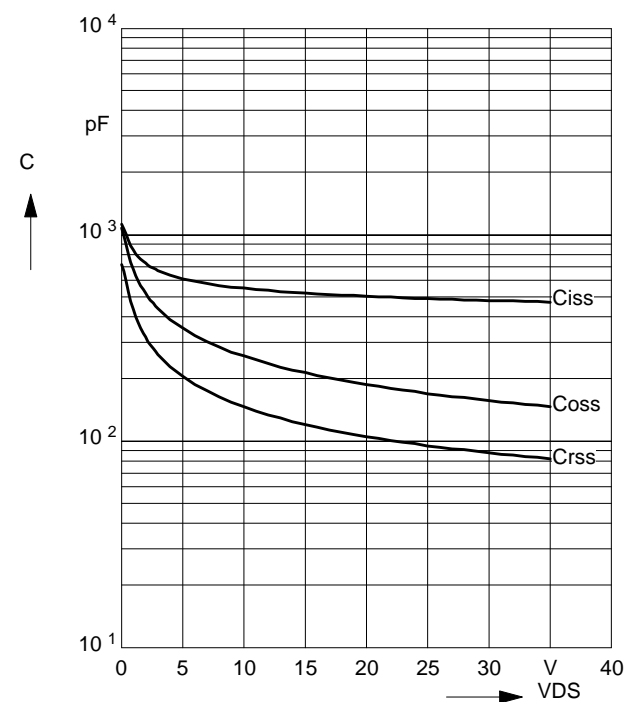

### Forward characteristics of reverse diode

$$I_F = f(V_{SD})$$

parameter:  $T_j$ ,  $t_p = 80\text{ }\mu\text{s}$

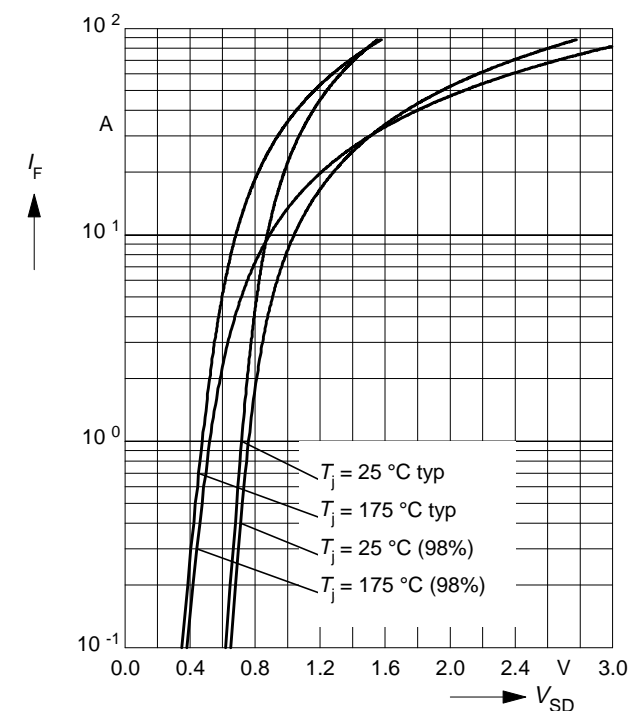

### Avalanche energy $E_{AS} = f(T_j)$

parameter:  $I_D = 22A, V_{DD} = 25V$

$R_{GS} = 25\ \Omega, L = 372\ \mu H$

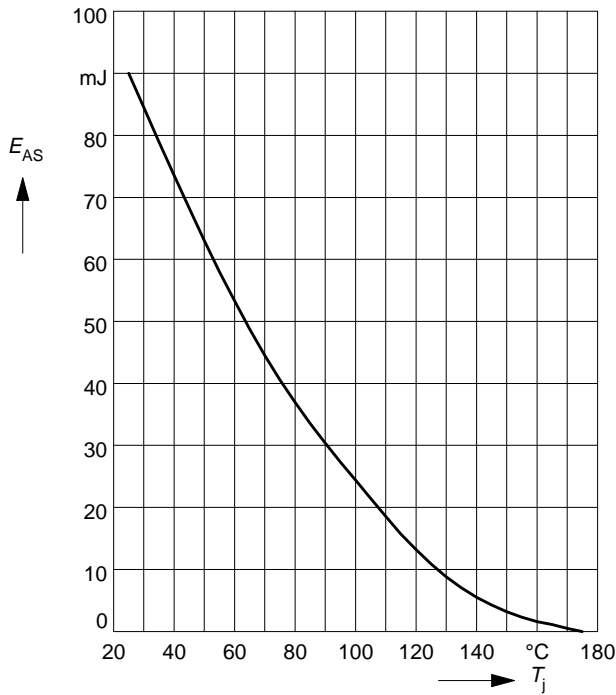

### Typ. gate charge

$V_{GS} = f(Q_{Gate})$

parameter:  $I_{D\ puls} = 22\ A$

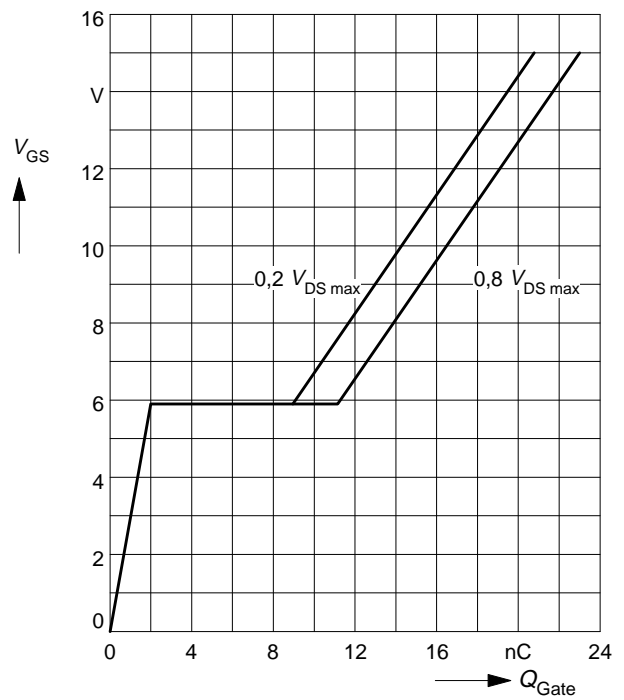

### Drain-source breakdown voltage

$V_{(BR)DSS} = f(T_j)$

