

**SPI-335-34**

Ultraminiature photoreflector (single-transistor type)

Features

- Infrared LED plus Phototransistor (single)
- DIP type
- Compact type : 3.4 (L) × 2.7 (W) × 1.5 (H) mm
- Visible light cut type
- Lead length : (L=3.5mm)

Absolute Maximum Ratings at Ta=25°C, 65%RH

Parameter		Symbol	Rating	Unit
Input LED	Forward Current	I_F	50	mA
	Reverse Voltage	V_R	5	V
	Power Dissipation	P_D	70	mW
Output Phototransistor	Collector-Emitter Voltage	V_{CEO}	20	V
	Emitter-Collector Voltage	V_{ECO}	5	V
	Collector Current	I_C	20	mA
	Power Dissipation	P_C	70	mW
Operating Temperature		T_{opr}	-20 to +80	°C
Storage Temperature		T_{stg}	-40 to +100	°C
Soldering Temperature *1		T_{sol}	260	°C

*1 Soldering conditions : time : max. 3sec; clearance : min. 1mm from lower case edge.

Electro-Optical Characteristics at Ta=25°C, 65%RH

Parameter		Symbol	Condition	Min.	Typ.	Max.	Unit
Input	Forward Voltage	V_F	$I_F=10\text{mA}$	1.0	1.2	1.6	V
	Reverse Current	I_R	$V_R=5\text{V}$	-	-	10	μA
Output	Dark Current	I_{CEO}	$I_F=0\text{mA}, V_{CE}=10\text{V}$	-	10	200	nA
Coupled	Collector Output Current	I_C	$I_F=4\text{mA}, V_{CE}=5\text{V}^{*1}$	33	-	180	μA
	Leakage Current	I_{LEAK}	$I_F=10\text{mA}, V_{CE}=5\text{V}^{*2}$	-	-	1	μA
	Collector Emitter Saturation Voltage	$V_{CE(sat)}$	$I_F=10\text{mA}, I_C=50\mu\text{A}$	-	-	0.5	V
	Rise Time	t_r	$V_{CC}=5\text{V}, R_L=100\Omega$	-	5	-	μs
Fall Time	t_f	$I_C=1\text{mA}$	-	5	-	μs	

*1 Location of reflector is show in Fig. 1.

*2 No reflector

*3 Table of Classification of Collector Output

Class	E	F	G	H
I_C (μA)	180 to 110	140 to 80	100 to 50	65 to 33
Marking color	Orange	Green	White	Silver

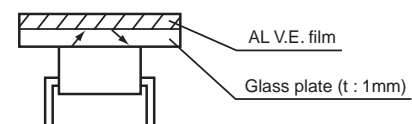

Fig. 1 Location of Reflector

SANYO Electric Co.,Ltd. Semiconductor Company

TOKYO OFFICE Tokyo Bldg., 1-10, 1 Chome, Ueno, Taito-ku, TOKYO, 110-8534 JAPAN

72199 GI, (MI) No.6029 1/6

Package dimensions and Pin connection

As stated in the sttached paper. (No.6029 5/6)

Rank marking of collector output

The bottom of the package is colored following the table of classification of collector output.

Lot marking

Color division shall be done as shown in the drawing. (Fig. 2)

Year of even number : Front side
 Year of odd number : Back side

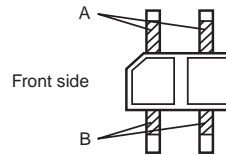

Fig. 2

Color	Black	Blue	Red	Green	Orange	Brown
Part 'A'	January	February	March	April	May	June
Part 'B'	July	August	September	October	November	December

Soldering conditions

- (1) Temperature : Max. 260°C
- (2) Time : Max. 3sec
- (3) Clearance : Min. 1mm from the case edge. (Fig. 3)

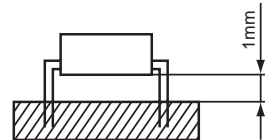
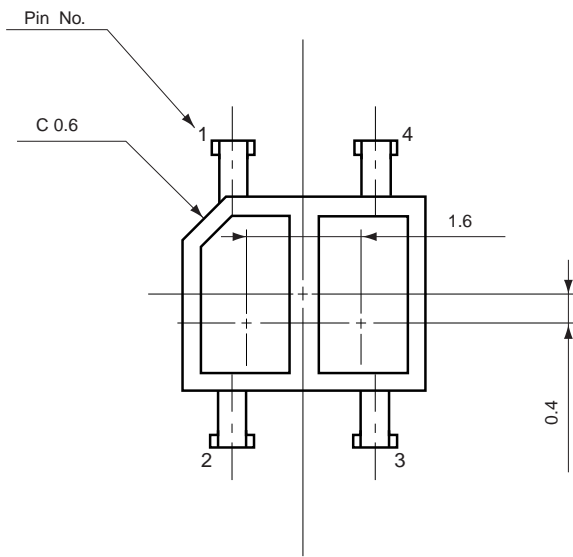

Fig. 3

▲ PRECAUTIONS

- (1) Bending a lead should avoid. However, when bending is necessary, take care the next items.
 - ① Bending a lead must be done before soldering.
 - ② Bending a lead must be done in the states of fixing leads and no stress for the regin part. Because it is possible that stress for the regin part cause troubles such as gold wire breaking and so on.
 - ③ A lead must be bend at intervals of 2mm from the case edge.
 - ④ Do not bend the same position of leads more than twice.
- (2) The hole pitch of a circuit board must fit to the lead pitch.
- (3) Take core the following when soldering.
 - ① Do not heat a product under any stress (a twist and so on) to leads.
 - ② Do not heat a product in the states of operating force to the regin part.
- (4) Use the flux which contain no chlorine, have no corrosion and do not need washing.
- (5) Be careful that flux or other chemicals do not attach to the luminous surface and passive surface.

SPI-335-34



- Pin Connection
1. Ph. Tr Emitter
 2. Ph. Tr Collector
 3. LED Cathode
 4. LED Anode

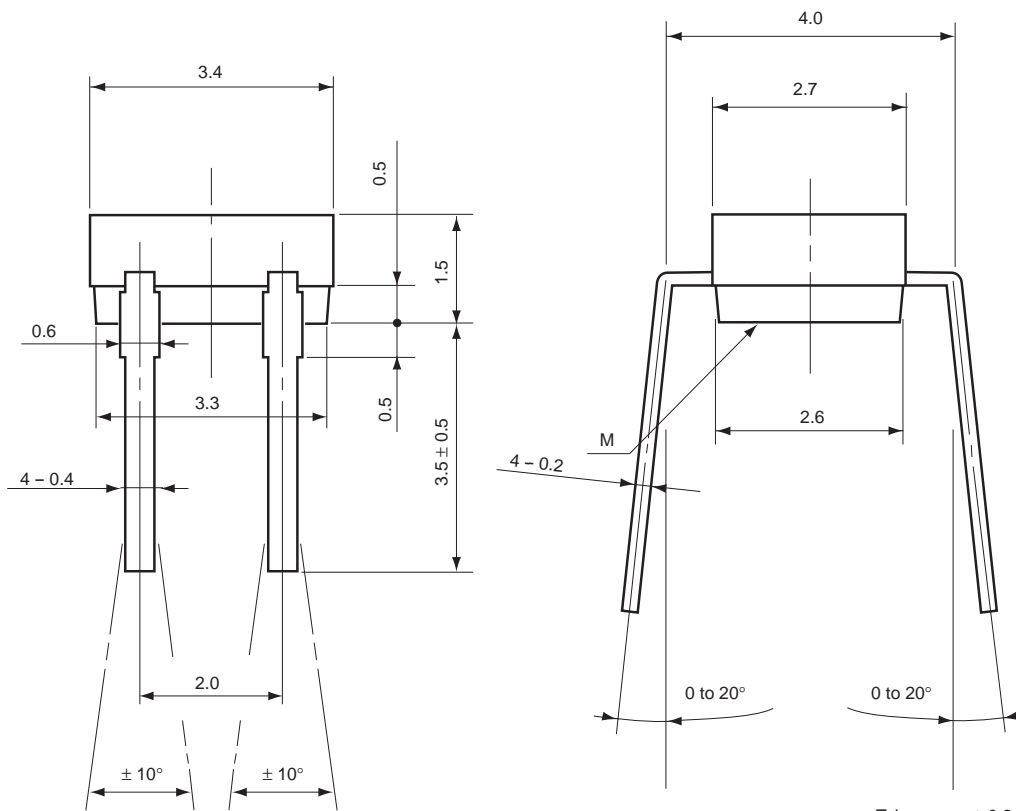
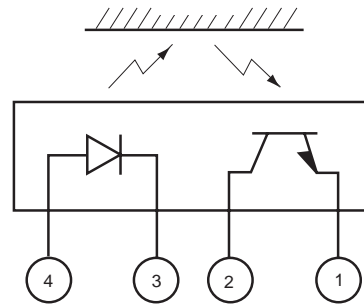

* M : Color marking of Ic class

Tolerance : ± 0.2
Unit : mm

Typical Characteristics



These numerical value show the electrical and optical characteristics of this product, and not assure this contents.

Forward Current vs. Ambient Temperature (Rating)

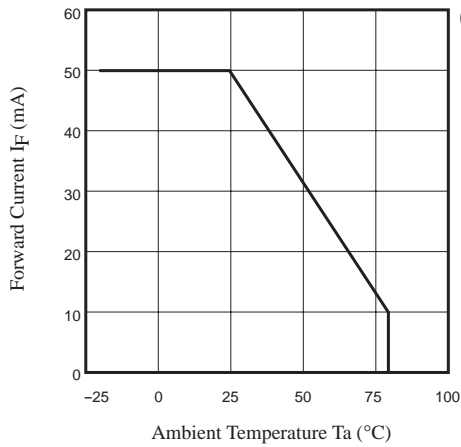

Power Dissipation vs. Ambient Temperature (Rating)

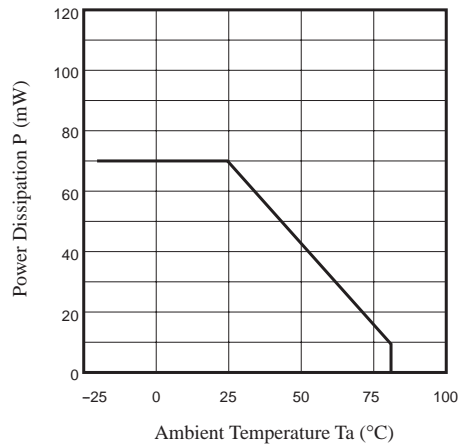

Forward Current vs. Forward Voltage

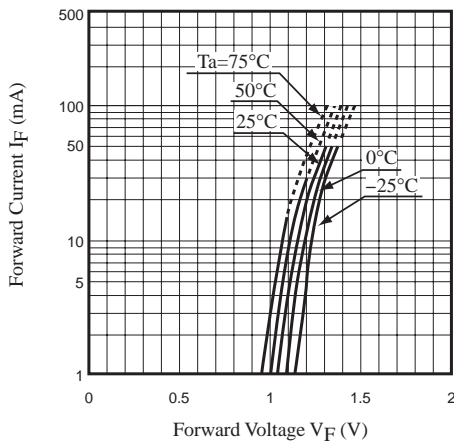

Collector vs. Forward Current

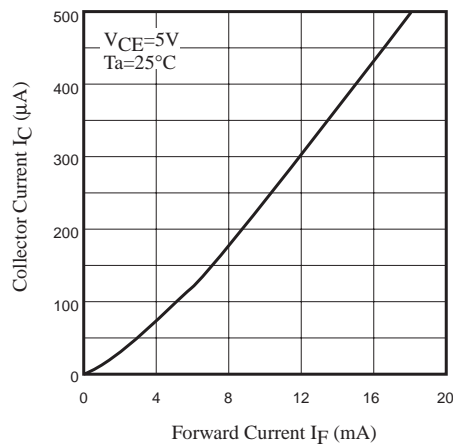

Collector Current vs. Collector-emitter Voltage

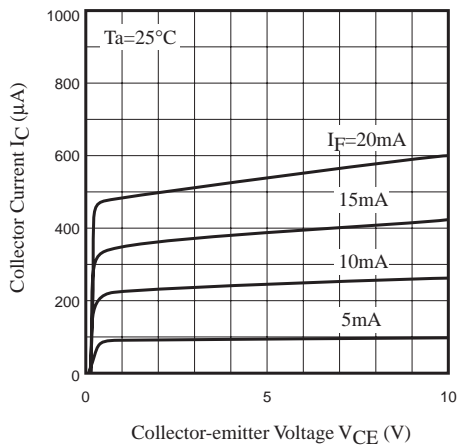

Relative Collector Current vs. Ambient Temperature

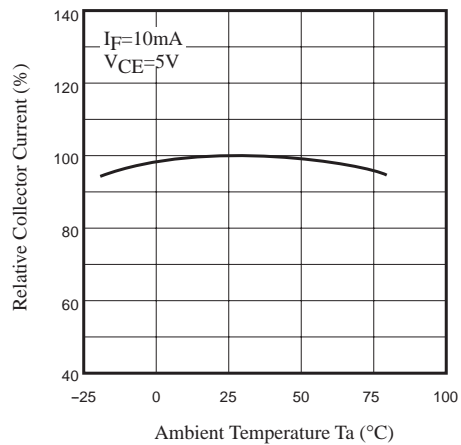

Typical Characteristics



These numerical value show the electrical and optical characteristics of this product, and not assure this contents.

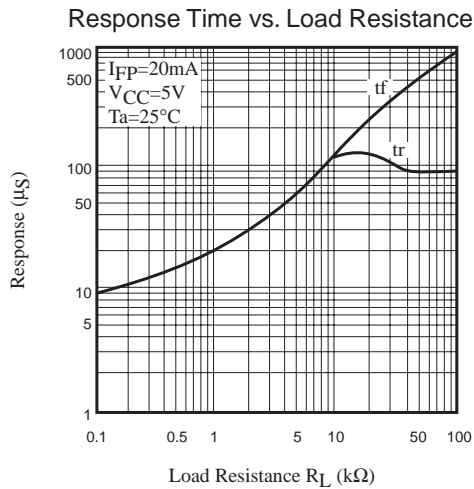
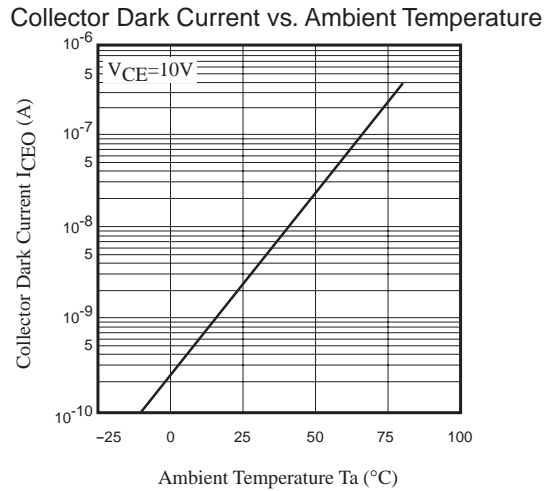
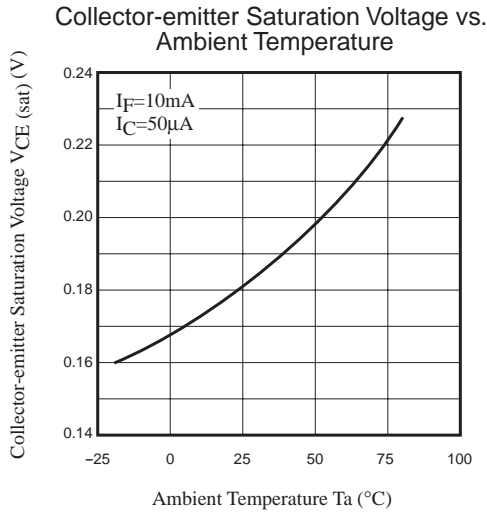

Test Circuit for Response Time

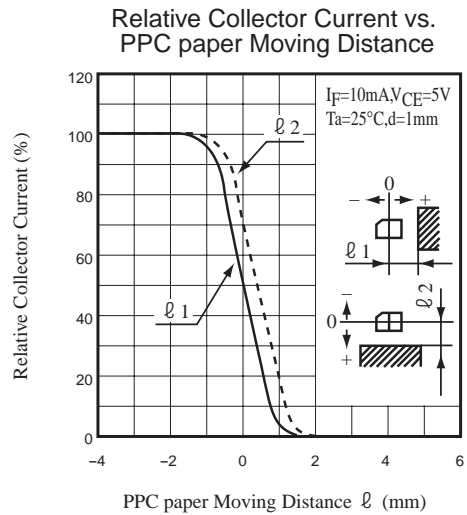
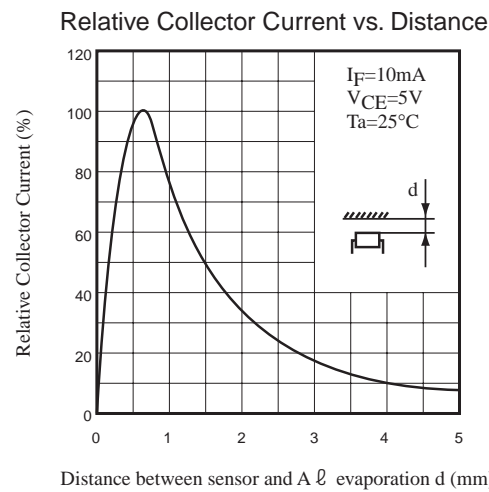
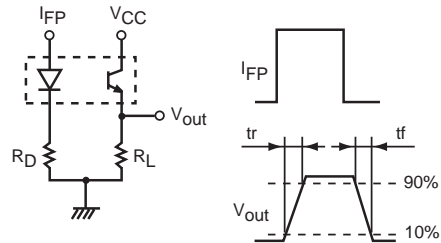

 **CAUTION**

1. No products described or contained herein are intended for use in surgical implants, life-support systems, aerospace equipment, nuclear power control systems, vehicles, disaster / crime-prevention equipment or the like, and the failure of which may directly or indirectly cause injury, death or property loss.
2. Anyone purchasing any products described or contained herein for an above-mentioned use shall:
 - 1) Accept full responsibility and indemnify and defend SANYO ELECTRIC CO.,LTD., it's affiliates, subsidiaries and distributors or any of their officers and employees, jointly and severally, against any and all claims and litigation and all damages, costs and expenses associated with such use.
 - 2) Not impose any responsibility for any fault or negligence which may be cited in any such claim or litigation on SANYO ELECTRIC CO., LTD., it's affiliates, subsidiaries and distributors or any of their officers and employees jointly or severally.
3. Information (including circuit diagrams and circuit parameters) disclosed herein is for example only; it is not guaranteed for mass production, SANYO believes the information disclosed herein is accurate and reliable, but no guarantees are made or implied regarding it's use or any infringements of intellectual property rights or other rights of third parties.

Precautionary instructions in handling gallium arsenic products

Special precautions must be taken in handling this product because it contains, gallium arsenic, which is designated as a toxic substance by law. Be sure to adhere strictly to all applicable laws and regulations enacted for this substance, particularly when it comes to disposal.

Manufactured by ; **Tottori SANYO Electric Co., Ltd.**
LED Division
5-318, Tachikawa-cho, Tottori City, 680-8634 Japan
TEL: +81-857-21-2137 FAX: +81-857-21-2161