

# NTF3055-100

Preferred Device

## Power MOSFET 3.0 Amps, 60 Volts N-Channel SOT-223

Designed for low voltage, high speed switching applications in power supplies, converters and power motor controls and bridge circuits.

### Applications

- Power Supplies
- Converters
- Power Motor Controls
- Bridge Circuits

### MAXIMUM RATINGS ( $T_C = 25^\circ\text{C}$ unless otherwise noted)

Rating	Symbol	Value	Unit
Drain-to-Source Voltage	$V_{DSS}$	60	Vdc
Drain-to-Gate Voltage ( $R_{GS} = 10\text{ M}\Omega$ )	$V_{DGR}$	60	Vdc
Gate-to-Source Voltage	$V_{GS}$	$\pm 20$	Vdc
– Continuous – Non-repetitive ( $t_p \leq 10\text{ ms}$ )		$\pm 30$	Vpk
Drain Current	$I_D$ $I_{DM}$	3.0	Adc
– Continuous @ $T_A = 25^\circ\text{C}$		1.4	
– Continuous @ $T_A = 100^\circ\text{C}$		9.0	Apk
– Single Pulse ( $t_p \leq 10\text{ }\mu\text{s}$ )			
Total Power Dissipation @ $T_A = 25^\circ\text{C}$ (Note 1.)	$P_D$	2.1	W
Total Power Dissipation @ $T_A = 25^\circ\text{C}$ (Note 2.)		1.3	W
Derate above $25^\circ\text{C}$		0.014	W/ $^\circ\text{C}$
Operating and Storage Temperature Range	$T_J, T_{stg}$	-55 to 175	$^\circ\text{C}$
Single Pulse Drain-to-Source Avalanche Energy – Starting $T_J = 25^\circ\text{C}$ ( $V_{DD} = 25\text{ Vdc}$ , $V_{GS} = 10\text{ Vdc}$ , $I_L(\text{pk}) = 7.0\text{ Apk}$ , $L = 3.0\text{ mH}$ , $V_{DS} = 60\text{ Vdc}$ )	$E_{AS}$	74	mJ
Thermal Resistance	$R_{\theta JA}$	72.3	$^\circ\text{C/W}$
– Junction to Ambient (Note 1.) – Junction to Ambient (Note 2.)		114	
Maximum Lead Temperature for Soldering Purposes, 1/8" from case for 10 seconds	$T_L$	260	$^\circ\text{C}$

1. When surface mounted to an FR4 board using 1" pad size, 1 oz. (Cu. Area 1.127 in<sup>2</sup>).
2. When surface mounted to an FR4 board using minimum recommended pad size, 2–2.4 oz. (Cu. Area 0.272 in<sup>2</sup>).



ON Semiconductor™

<http://onsemi.com>

**3.0 AMPERES  
60 VOLTS  
RDS(on) = 100 mΩ**

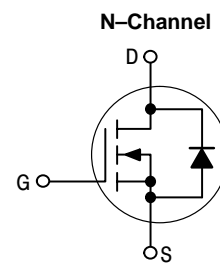

### MARKING DIAGRAM

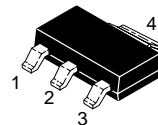

**SOT-223  
CASE 318E  
STYLE 3**

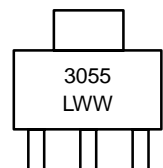

3055 = Device Code  
L = Location Code  
WW = Work Week

### PIN ASSIGNMENT

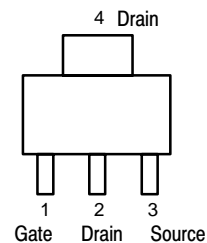

### ORDERING INFORMATION

Device	Package	Shipping
NTF3055-100T1	SOT-223	1000 Tape & Reel
NTF3055-100T3	SOT-223	4000 Tape & Reel
NTF3055-100T3LF	SOT-223	4000 Tape & Reel

[www.DataSheet4U.com](http://www.DataSheet4U.com)

# NTF3055-100

## ELECTRICAL CHARACTERISTICS (T<sub>A</sub> = 25°C unless otherwise noted)

Characteristic	Symbol	Min	Typ	Max	Unit
----------------	--------	-----	-----	-----	------

### OFF CHARACTERISTICS

Drain-to-Source Breakdown Voltage (Note 3.) (V <sub>GS</sub> = 0 Vdc, I <sub>D</sub> = 250 μAdc) Temperature Coefficient (Positive)	V <sub>(BR)DSS</sub>	60 –	68 66	– –	Vdc mV/°C
Zero Gate Voltage Drain Current (V <sub>DS</sub> = 60 Vdc, V <sub>GS</sub> = 0 Vdc) (V <sub>DS</sub> = 60 Vdc, V <sub>GS</sub> = 0 Vdc, T <sub>J</sub> = 150°C)	I <sub>DSS</sub>	– –	– –	1.0 10	μAdc
Gate-Body Leakage Current (V <sub>GS</sub> = ± 20 Vdc, V <sub>DS</sub> = 0 Vdc)	I <sub>GSS</sub>	–	–	± 100	nAdc

### ON CHARACTERISTICS (Note 3.)

Gate Threshold Voltage (Note 3.) (V <sub>DS</sub> = V <sub>GS</sub> , I <sub>D</sub> = 250 μAdc) Threshold Temperature Coefficient (Negative)	V <sub>GS(th)</sub>	2.0 –	3.0 6.6	4.0 –	Vdc mV/°C
Static Drain-to-Source On-Resistance (Note 3.) (V <sub>GS</sub> = 10 Vdc, I <sub>D</sub> = 1.5 Adc)	R <sub>DS(on)</sub>	–	88	100	mΩ
Static Drain-to-Source On-Resistance (Note 3.) (V <sub>GS</sub> = 10 Vdc, I <sub>D</sub> = 3.0 Adc) (V <sub>GS</sub> = 10 Vdc, I <sub>D</sub> = 1.5 Adc, T <sub>J</sub> = 150°C)	V <sub>DS(on)</sub>	–	0.27 0.24	0.36 –	Vdc
Forward Transconductance (Note 3.) (V <sub>DS</sub> = 8.0 Vdc, I <sub>D</sub> = 1.7 Adc)	g <sub>fs</sub>	–	3.2	–	Mhos

### DYNAMIC CHARACTERISTICS

Input Capacitance	(V <sub>DS</sub> = 25 Vdc, V <sub>GS</sub> = 0 V, f = 1.0 MHz)	C <sub>iss</sub>	–	324	455	pF
Output Capacitance		C <sub>oss</sub>	–	35	50	
Transfer Capacitance		C <sub>rss</sub>	–	110	155	

### SWITCHING CHARACTERISTICS (Note 4.)

Turn-On Delay Time	(V <sub>DD</sub> = 30 Vdc, I <sub>D</sub> = 3.0 Adc, V <sub>GS</sub> = 10 Vdc, R <sub>G</sub> = 9.1 Ω) (Note 3.)	t <sub>d(on)</sub>	–	9.4	20	ns
Rise Time		t <sub>r</sub>	–	14	30	
Turn-Off Delay Time		t <sub>d(off)</sub>	–	21	45	
Fall Time		t <sub>f</sub>	–	13	30	
Gate Charge	(V <sub>DS</sub> = 48 Vdc, I <sub>D</sub> = 3.0 Adc, V <sub>GS</sub> = 10 Vdc) (Note 3.)	Q <sub>T</sub>	–	10.6	22	nC
		Q <sub>1</sub>	–	1.9	–	
		Q <sub>2</sub>	–	4.2	–	

### SOURCE-DRAIN DIODE CHARACTERISTICS

Forward On-Voltage	(I <sub>S</sub> = 3.0 Adc, V <sub>GS</sub> = 0 Vdc) (I <sub>S</sub> = 3.0 Adc, V <sub>GS</sub> = 0 Vdc, T <sub>J</sub> = 150°C) (Note 3.)	V <sub>SD</sub>	– –	0.89 0.74	1.0 –	Vdc
Reverse Recovery Time	(I <sub>S</sub> = 3.0 Adc, V <sub>GS</sub> = 0 Vdc, dI <sub>S</sub> /dt = 100 A/μs) (Note 3.)	t <sub>rr</sub>	–	30	–	ns
		t <sub>a</sub>	–	22	–	
		t <sub>b</sub>	–	8.6	–	
Reverse Recovery Stored Charge		Q <sub>RR</sub>	–	0.04	–	μC

3. Pulse Test: Pulse Width ≤ 300 μs, Duty Cycle ≤ 2.0%.

4. Switching characteristics are independent of operating junction temperatures.

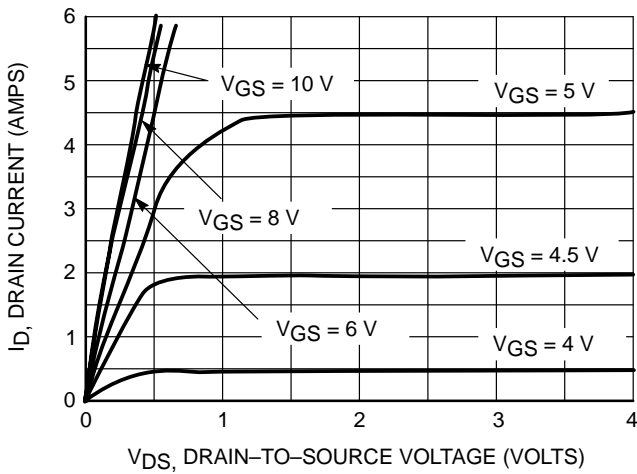

Figure 1. On-Region Characteristics

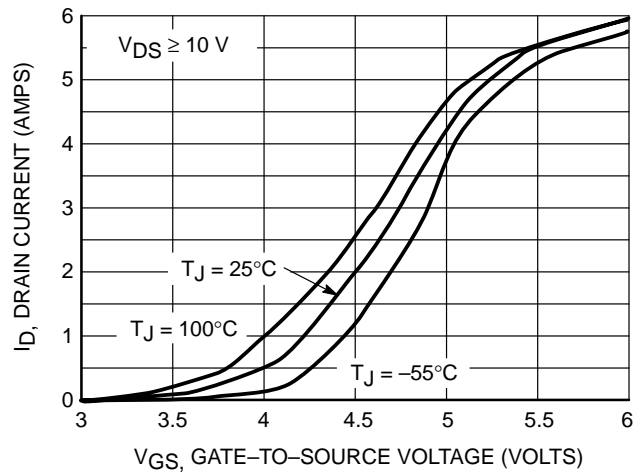

Figure 2. Transfer Characteristics

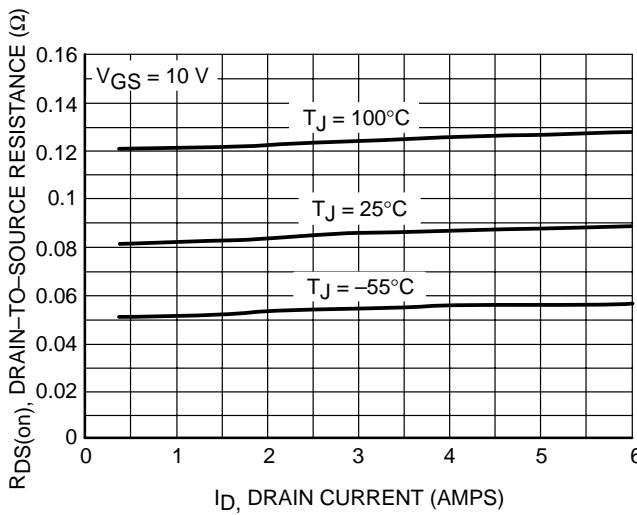

Figure 3. On-Resistance versus Gate-to-Source Voltage

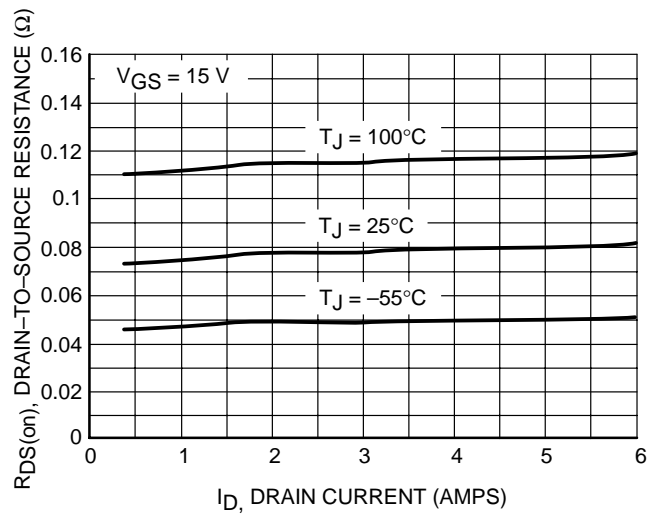

Figure 4. On-Resistance versus Drain Current and Gate Voltage

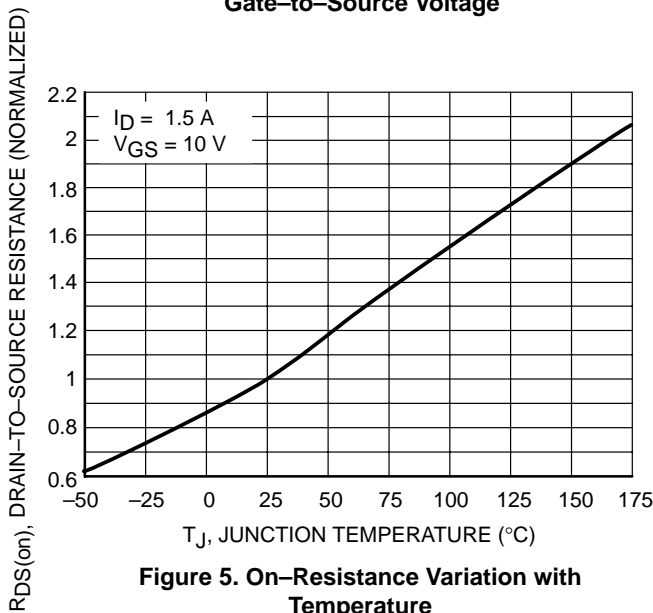

Figure 5. On-Resistance Variation with Temperature

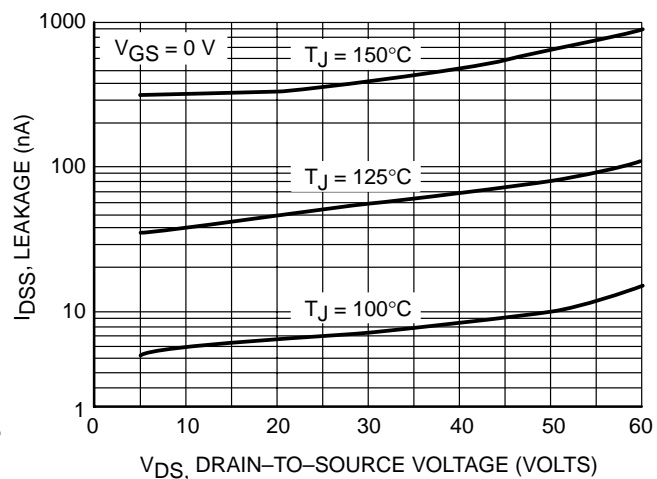

Figure 6. Drain-to-Source Leakage Current versus Voltage

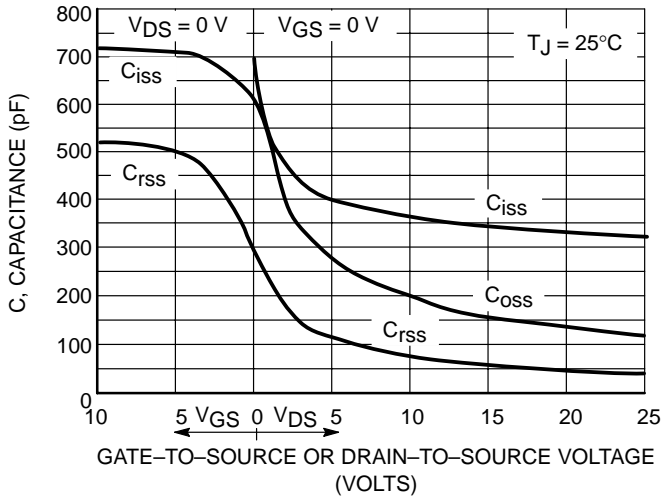

Figure 7. Capacitance Variation

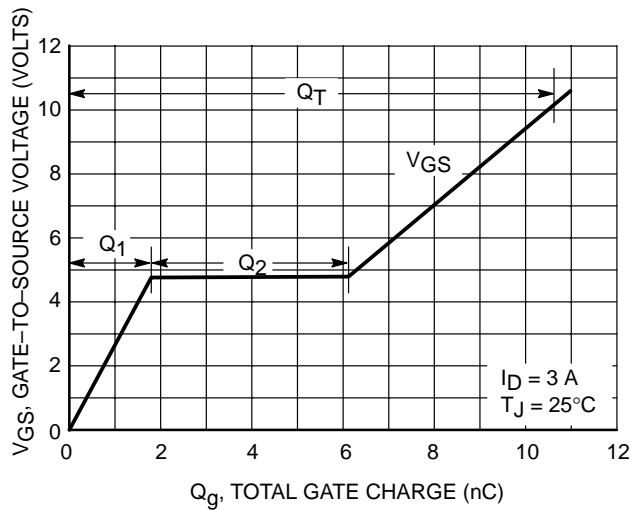

Figure 8. Gate-to-Source and Drain-to-Source Voltage versus Total Charge

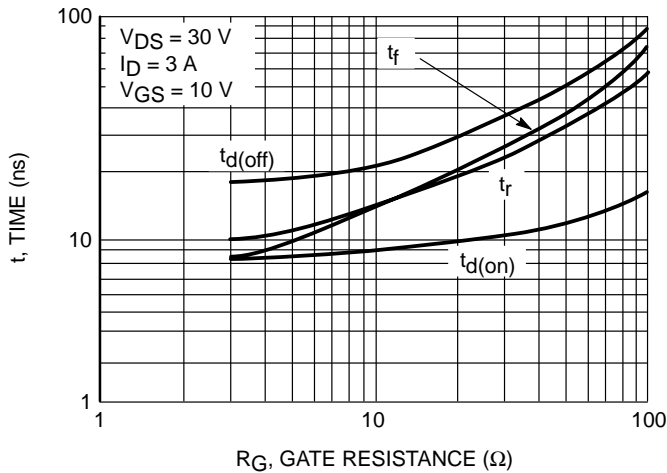

Figure 9. Resistive Switching Time Variation versus Gate Resistance

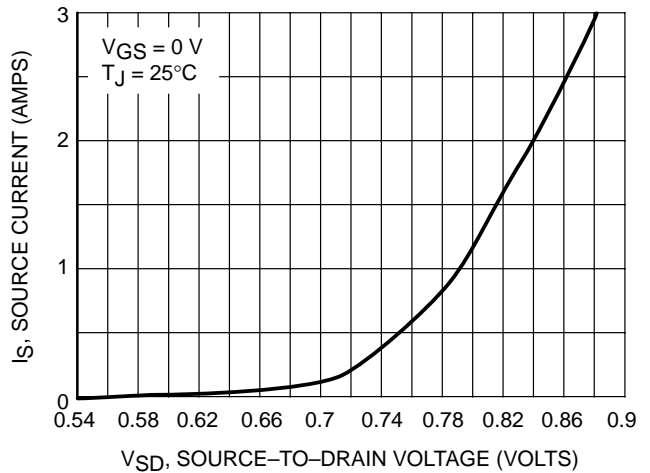

Figure 10. Diode Forward Voltage versus Current

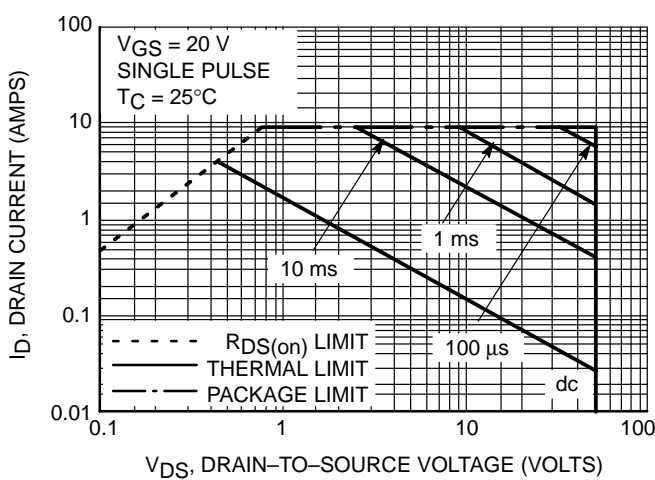

Figure 11. Maximum Rated Forward Biased Safe Operating Area

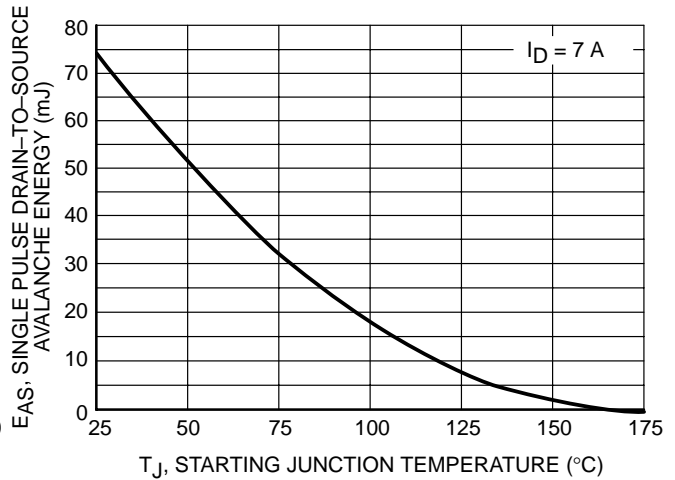

Figure 12. Maximum Avalanche Energy versus Starting Junction Temperature

# NTF3055-100

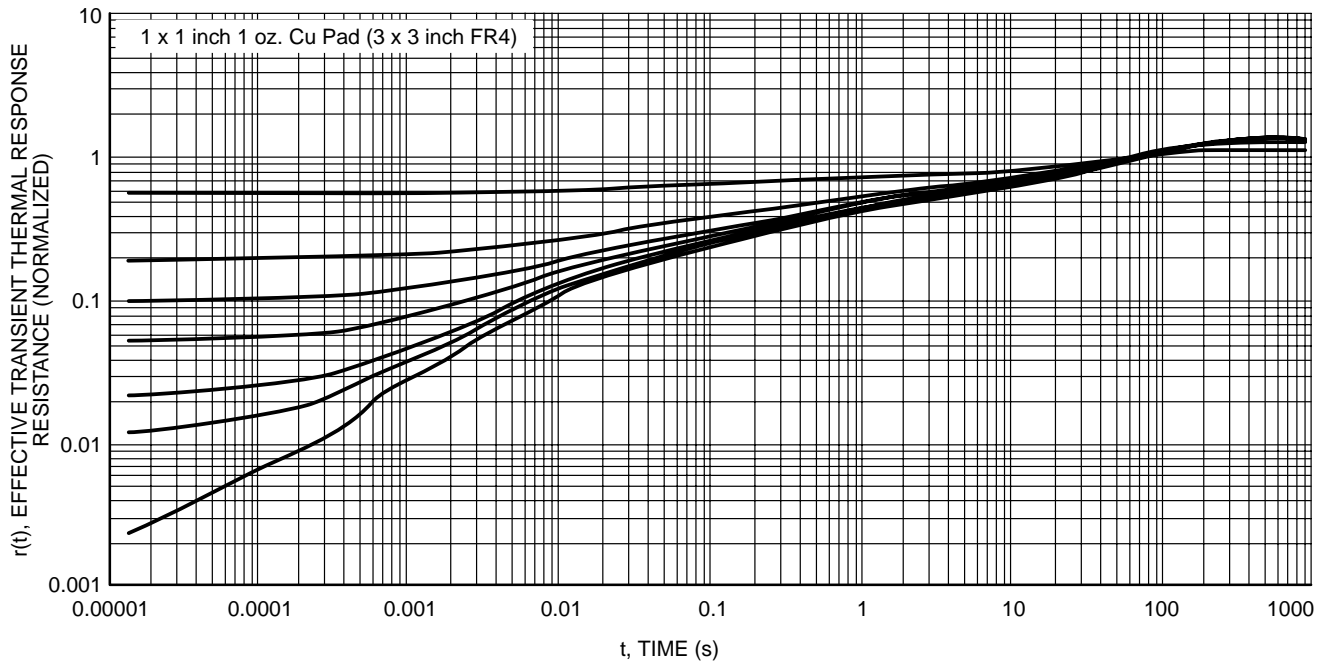

Figure 13. Thermal Response

# NTF3055-100

## PACKAGE DIMENSIONS

SOT-223 (TO-261)

CASE 318E-04

ISSUE K

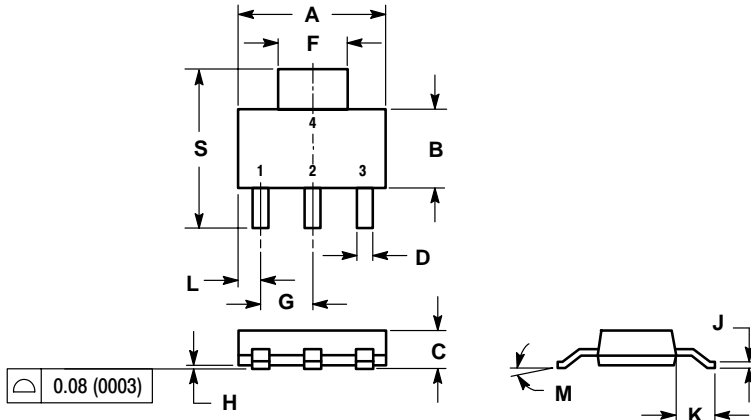

- NOTES:
1. DIMENSIONING AND TOLERANCING PER ANSI Y14.5M, 1982.
  2. CONTROLLING DIMENSION: INCH.

DIM	INCHES		MILLIMETERS	
	MIN	MAX	MIN	MAX
A	0.249	0.263	6.30	6.70
B	0.130	0.145	3.30	3.70
C	0.060	0.068	1.50	1.75
D	0.024	0.035	0.60	0.89
F	0.115	0.126	2.90	3.20
G	0.087	0.094	2.20	2.40
H	0.0008	0.0040	0.020	0.100
J	0.009	0.014	0.24	0.35
K	0.060	0.078	1.50	2.00
L	0.033	0.041	0.85	1.05
M	0°	10°	0°	10°
S	0.264	0.287	6.70	7.30

- STYLE 3:
- PIN 1. GATE
  2. DRAIN
  3. SOURCE
  4. DRAIN

**Notes**

**ON Semiconductor** and  are trademarks of Semiconductor Components Industries, LLC (SCILLC). SCILLC reserves the right to make changes without further notice to any products herein. SCILLC makes no warranty, representation or guarantee regarding the suitability of its products for any particular purpose, nor does SCILLC assume any liability arising out of the application or use of any product or circuit, and specifically disclaims any and all liability, including without limitation special, consequential or incidental damages. "Typical" parameters which may be provided in SCILLC data sheets and/or specifications can and do vary in different applications and actual performance may vary over time. All operating parameters, including "Typicals" must be validated for each customer application by customer's technical experts. SCILLC does not convey any license under its patent rights nor the rights of others. SCILLC products are not designed, intended, or authorized for use as components in systems intended for surgical implant into the body, or other applications intended to support or sustain life, or for any other application in which the failure of the SCILLC product could create a situation where personal injury or death may occur. Should Buyer purchase or use SCILLC products for any such unintended or unauthorized application, Buyer shall indemnify and hold SCILLC and its officers, employees, subsidiaries, affiliates, and distributors harmless against all claims, costs, damages, and expenses, and reasonable attorney fees arising out of, directly or indirectly, any claim of personal injury or death associated with such unintended or unauthorized use, even if such claim alleges that SCILLC was negligent regarding the design or manufacture of the part. SCILLC is an Equal Opportunity/Affirmative Action Employer.

## PUBLICATION ORDERING INFORMATION

### Literature Fulfillment:

Literature Distribution Center for ON Semiconductor  
P.O. Box 5163, Denver, Colorado 80217 USA  
**Phone:** 303-675-2175 or 800-344-3860 Toll Free USA/Canada  
**Fax:** 303-675-2176 or 800-344-3867 Toll Free USA/Canada  
**Email:** ONlit@hibbertco.com

**N. American Technical Support:** 800-282-9855 Toll Free USA/Canada

**JAPAN:** ON Semiconductor, Japan Customer Focus Center  
4-32-1 Nishi-Gotanda, Shinagawa-ku, Tokyo, Japan 141-0031  
**Phone:** 81-3-5740-2700  
**Email:** r14525@onsemi.com

**ON Semiconductor Website:** <http://onsemi.com>

For additional information, please contact your local Sales Representative.