

Application Note

AN2530/D
Rev. 0, 5/2003

Standard Space Vector
Modulation with Dead-Time
Correction TPU Function Set
(svmStdDt)



By Milan Brejl, Ph.D.

Functional Overview

The Standard Space Vector Modulation with Dead-Time Correction TPU function set (svmStdDt) extends the functionality of the Standard Space Vector Modulation TPU function set (svmStd) by the dead-time correction technique. Apart from this the functionality is the same in all aspects.

The dead-time correction technique requires knowledge of the instantaneous direction of phase currents. In the case of positive phase current the top channel high-time is equal to the calculated high-time and the bottom channel has to control the dead-time. In the case of negative phase current the bottom channel low-time is equal to the calculated high-time and the top channel has to control the dead-time. See [Figure 1](#).

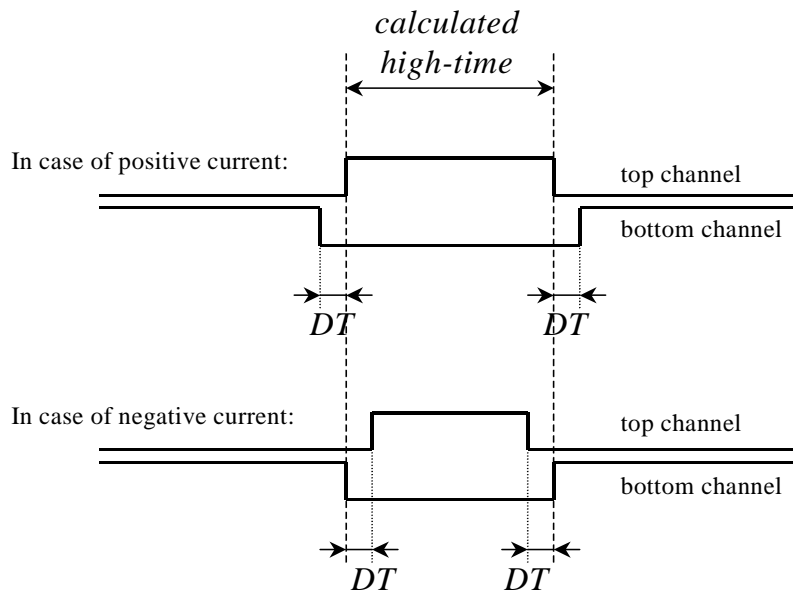

Figure 1. Dead-Time Correction Technique

The function set consists of 5 TPU functions:

- Standard Space Vector Modulation with Dead-Time Correction – Top (svmStdDt_top)
- Standard Space Vector Modulation with Dead-Time Correction – Bottom (svmStdDt_bottom)
- Synchronization signal for Standard Space Vector Modulation with Dead-Time Correction (svmStdDt_sync)
- Resolver Reference Signal for Standard Space Vector Modulation with Dead-Time Correction (svmStdDt_res)
- Fault Input for Standard Space Vector Modulation with Dead-Time Correction (svmStdDt_fault)

The svmStdDt_top and svmStdDt_bottom TPU functions work together to generate a 6-channel 3-phase center-aligned PWM signal with dead-time between the top and bottom channels. The Synchronization Signal for svmStdDt function can be used to generate one or more adjustable signals for a wide range of uses, that are synchronized to the PWM, and track changes in the PWM period. The Resolver Reference Signal for svmStdDt function can be used to generate one or more 50% duty-cycle adjustable signals that are also synchronized to the PWM. The Fault Input for svmStdDt function is a TPU input function that sets all PWM outputs low when the input signal goes low. See [Figure 2](#).

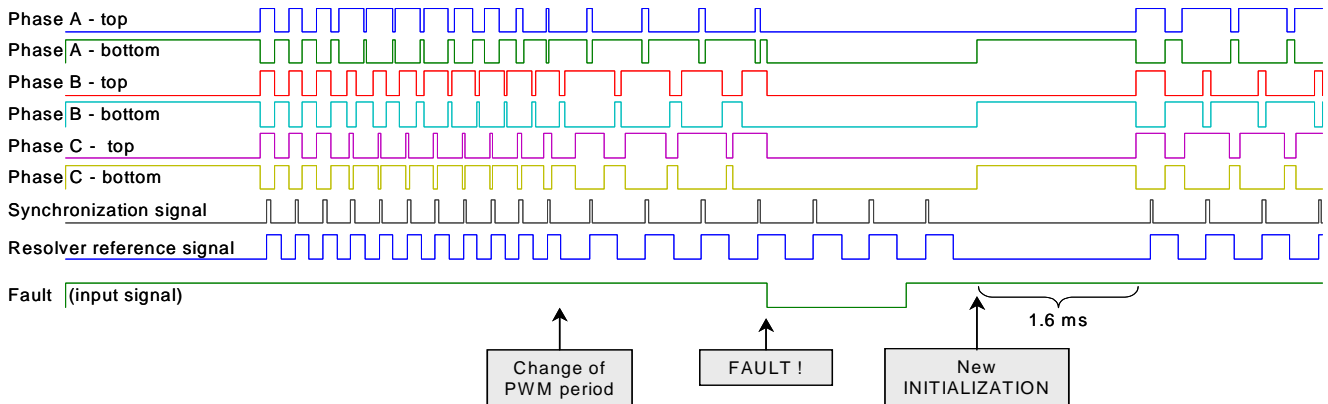

Figure 2. Signals generated by svmStdDt TPU function set

Function Set Configuration

None of the TPU functions in the Standard Space Vector Modulation with Dead-Time Correction TPU function set can be used separately. The svmStdDt_top and svmStdDt_bottom functions have to be used together. The svmStdDt_top is used on 3 channels, the svmStdDt_bottom on a further 3 channels, and within each phase, the function svmStdDt_top has to be assigned on a lower TPU channel than the function svmStdDt_bottom. This is illustrated in the examples in [Table 2](#) and [Table 3](#). One or more channels running Synchronization Signal for svmStdDt as well as Resolver Reference Signals for svmStdDt functions can be added to the svmStdDt_top and svmStdDt_bottom functions. They can run with different settings on each channel. The function Fault Input for svmStdDt can also be added to the svmStdDt_top and svmStdDt_bottom functions. It is recommended to use it on channel 15, and to set the hardware option that disables all TPU output pins when the channel 15 input signal is low (DTPU bit = 1). This ensures that the hardware reacts quickly to a pin fault state. Note that it is not only the PWM channels, but all TPU output channels, including the synchronization signals, that are disabled in this configuration.

[Table 1](#) shows the configuration options and restrictions.

Table 1. svmStdDt TPU function set configuration options and restrictions

| TPU function | Optional/Mandatory | How many channels | Assignable channels |
|-----------------|--------------------|-------------------|---|
| svmStdDt_top | mandatory | 3 | any 3 channels, within each phase a lower TPU channel than the same phase svmStdDt_bottom |
| svmStdDt_bottom | mandatory | 3 | any 3 channels, within each phase a higher TPU channel than the same phase svmStdDt_top |
| svmStdDt_sync | optional | 1 or more | any channels |
| svmStdDt_res | optional | 1 or more | any channels |
| svmStdDt_fault | optional | 1 | any, recommended is 15 and DTPU bit set |

[Table 2](#) and [Table 3](#) show two examples of configuration.

Table 2. Example of configuration

| Channel | TPU function | Priority |
|---------|--------------|----------|
| 0 | svmStdDt_top | high |

Table 2. Example of configuration

| Channel | TPU function | Priority |
|---------|-----------------|----------|
| 1 | svmStdDt_bottom | high |
| 2 | svmStdDt_top | high |
| 3 | svmStdDt_bottom | high |
| 4 | svmStdDt_top | high |
| 5 | svmStdDt_bottom | high |
| 10 | svmStdDt_sync | low |
| 15 | svmStdDt_fault | high |

Table 3. Example of configuration

| Channel | TPU function | Priority |
|---------|-----------------|----------|
| 0 | svmStdDt_top | high |
| 1 | svmStdDt_top | high |
| 2 | svmStdDt_top | high |
| 3 | svmStdDt_bottom | high |
| 4 | svmStdDt_bottom | high |
| 5 | svmStdDt_bottom | high |
| 10 | svmStdDt_sync | low |
| 11 | svmStdDt_res | low |
| 15 | svmStdDt_fault | high |

Table 4 shows the TPU function code sizes.

Table 4. TPU function code sizes

| TPU function | Code size |
|-----------------|---|
| svmStdDt_top | 26 μ instructions + 8 entries = 34 long words |
| svmStdDt_bottom | 196 μ instructions + 8 entries = 204 long words |
| svmStdDt_sync | 26 μ instructions + 8 entries = 34 long words |
| svmStdDt_res | 38 μ instructions + 8 entries = 46 long words |
| svmStdDt_fault | 9 μ instructions + 8 entries = 17 long words |

Configuration Order

The CPU configures the TPU as follows.

1. Disables the channels by clearing the two channel priority bits on each channel used (not necessary after reset).
2. Selects the channel functions on all used channels by writing the function numbers to the channel function select bits.
3. Initializes function parameters. The parameters *T*, *prescaler*, *DT*, *MPW*, *SQRT3* and *sync_presc_addr* must be set before initialization. If an

svmStdDt_sync channel or an svmStdDt_res channel is used, then also its parameters must be set before initialization.

4. Issues an HSR (Host Service Request) type %10 to one of the svmStdDt_bottom channels to initialize all PWM channels. Issues an HSR type %10 to the svmStdDt_sync channels, svmStdDt_res channels and svmStdDt_fault channel, if used.
5. Enables servicing by assigning high, middle or low priority to the channel priority bits. All PWM channels must be assigned the same priority to ensure correct operation. The CPU must ensure that the svmStdDt_sync or svmStdDt_res channels are initialized after the initialization of PWM channels:
 - assign a priority to the PWM channels to enable their initialization
 - if a Synchronization Signal or a Resolver Reference Signal channel is used, wait until the HSR bits are cleared to indicate that initialization of the PWM channels has completed and
 - assign a priority to the svmStdDt_sync or svmStdDt_res channels to enable their initialization

NOTE: A CPU routine that configures the TPU can be generated automatically using the MPC500_Quick_Start Graphical Configuration Tool.

Detailed Function Description

Standard Space Vector Modulation with Dead-Time Correction – Top (svmStdDt_top) and Standard Space Vector Modulation with Dead-Time Correction – Bottom (svmStdDt_bottom)

The svmStdDt_top and svmStdDt_bottom TPU functions work together to generate a 6-channel, 3-phase PWM signal, with dead-time between the top and bottom channels. In order to charge the bootstrap transistors, the PWM signals start to run 1.6ms after their initialization (at 20MHz TCR1 clock). The functions generate signals corresponding to Reference Voltage Vector Amplitude of 0 (50% duty-cycle) until the first reloaded values are processed.

The CPU controls the PWM output by setting the TPU parameters. The Stator Reference Voltage Vector components u_a and u_b have to be adjusted during run time. The PWM period T and the *prescaler* – the number of PWM periods per reload of new values – are also read at each reload, so these parameters can be changed during run time. Conversely, dead-time (DT) and minimum pulse width (MPW) are not supposed to be changed during run time. The phase currents *currentA*, *currentB* and *currentC* are read by the TPU asynchronously to the PWM parameters reload. They are read in the last part of edge-time calculation to reflect the latest state of the phase currents. The CPU notifies the TPU that the new reload values are prepared by setting the LD_OK parameter. The TPU notifies the CPU that the reload values have been read and new values can be written by clearing the LD_OK parameter.

The TPU writes the parameter Sector, which indicates the current Stator Reference Voltage Vector position in sector 1 to 6.

The following figures show the input Stator Reference Voltage Vector components $u_{\hat{a}}$ and $u_{\hat{\beta}}$, corresponding sectors and output PWM signal duty cycle ratios:

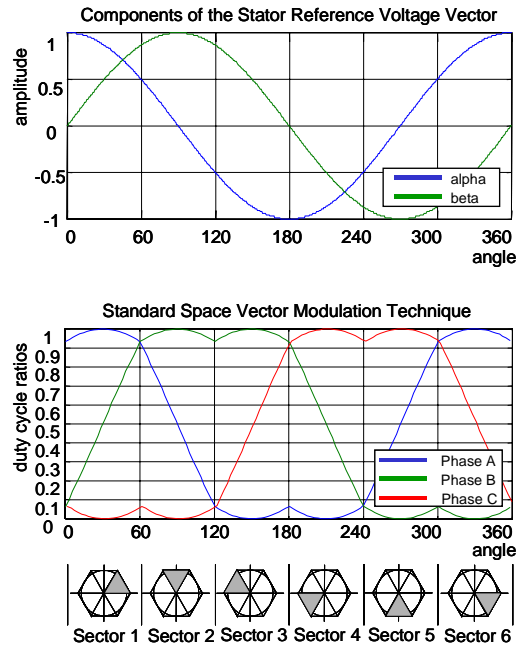

Figure 3. Standard Space Vector Modulation with Dead-Time Correction Technique

The following equations describe how the Space Vector Modulation PWM signal high-times ht_A , ht_B , ht_C and transition times $t_{low-high}$ and $t_{high-low}$ of each channel are calculated:

$$U_{\beta} = T \cdot u_{\beta}$$

$$U_{\alpha} = T \cdot u_{\alpha}$$

$$X = U_{\beta}$$

$$Y = \frac{U_{\beta} + U_{\alpha} \sqrt{3}}{2}$$

$$Z = \frac{U_{\beta} - U_{\alpha} \sqrt{3}}{2}$$

| | Y < 0 | | | Y >= 0 | | |
|----------------|-----------|------------|-------------|------------|-----------|------------|
| | Z < 0 | Z >= 0 | | Z < 0 | | Z >= 0 |
| | | X <= 0 | X > 0 | X <= 0 | X > 0 | |
| Sector: | V. | IV. | III. | VI. | I. | II. |

Phase A:

Positive current
top channel

$$t_{\text{low-high}} = \text{center_time} - \frac{ht_A}{2}$$

$$t_{\text{high-low}} = \text{center_time} + \frac{ht_A}{2}$$

bottom channel

$$t_{\text{high-low}} = \text{center_time} - \frac{ht_A}{2} - DT$$

$$t_{\text{low-high}} = \text{center_time} + \frac{ht_A}{2} + DT$$

Negative current
top channel

$$t_{\text{low-high}} = \text{center_time} - \frac{ht_A}{2} + DT$$

$$t_{\text{high-low}} = \text{center_time} + \frac{ht_A}{2} - DT$$

bottom channel

$$t_{\text{high-low}} = \text{center_time} - \frac{ht_A}{2}$$

$$t_{\text{low-high}} = \text{center_time} + \frac{ht_A}{2}$$

Phase B and Phase C similarly with ht_B and ht_C substituted to ht_A .

Host Interface



| | | | |
|---|----------------|--|-----------------------------|
|  | Written By CPU |  | Written by both CPU and TPU |
|  | Written By TPU |  | Not Used |

Table 5. svmStdDt_top Control Bits

| Name | Options |
|--|---|
| <div style="display: flex; justify-content: space-between; width: 100px;"> 3210 </div> <div style="display: flex; align-items: center;"> <div style="border: 1px solid black; width: 15px; height: 15px; margin-right: 5px;"></div> <div style="border: 1px solid black; width: 15px; height: 15px; margin-right: 5px;"></div> <div style="border: 1px solid black; width: 15px; height: 15px; margin-right: 5px;"></div> <div style="border: 1px solid black; width: 15px; height: 15px;"></div> </div> Channel Function Select | svmStdDt_top function number (Assigned during assembly the DPTRAM code from library TPU functions) |
| <div style="display: flex; justify-content: space-between; width: 100px;"> 10 </div> <div style="display: flex; align-items: center;"> <div style="border: 1px solid black; width: 15px; height: 15px; margin-right: 5px;"></div> <div style="border: 1px solid black; width: 15px; height: 15px;"></div> </div> Channel Priority | 00 – Channel Disabled 01 – Low Priority 10 – Middle Priority 11 – High Priority |
| <div style="display: flex; justify-content: space-between; width: 100px;"> 10 </div> <div style="display: flex; align-items: center;"> <div style="border: 1px solid black; width: 15px; height: 15px; margin-right: 5px;"></div> <div style="border: 1px solid black; width: 15px; height: 15px;"></div> </div> Host Service Bits (HSR) | 00 – No Host Service Request 01 – Not used 10 – Not used 11 – Not used |
| <div style="display: flex; justify-content: space-between; width: 100px;"> 10 </div> <div style="display: flex; align-items: center;"> <div style="background-color: green; width: 15px; height: 15px; margin-right: 5px;"></div> <div style="background-color: green; width: 15px; height: 15px;"></div> </div> Host Sequence Bits (HSQ) | xx – Not used |
| <div style="display: flex; justify-content: space-between; width: 100px;"> 0 </div> <div style="display: flex; align-items: center;"> <div style="background-color: green; width: 15px; height: 15px; margin-right: 5px;"></div> </div> Channel Interrupt Enable | x – Not used |

Table 5. svmStdDt_top Control Bits

| Name | Options |
|---|--------------|
| <div style="text-align: center;">0</div> Channel Interrupt Status | x – Not used |

Table 6. svmStdDt_bottom Control Bits

| Name | Options |
|--|--|
| <div style="text-align: center;">3 2 1 0</div> Channel Function Select | svmStdDt_bottom function number (Assigned during assembly the DPTRAM code from library TPU functions) |
| <div style="text-align: center;">1 0</div> Channel Priority | 00 – Channel Disabled 01 – Low Priority 10 – Middle Priority 11 – High Priority |
| <div style="text-align: center;">1 0</div> Host Service Bits (HSR) | 00 – No Host Service Request 01 – Not used 10 – Initialization 11 – Stop |
| <div style="text-align: center;">1 0</div> Host Sequence Bits (HSQ) | xx – Not used |
| <div style="text-align: center;">0</div> Channel Interrupt Enable | 0 – Channel Interrupt Disabled 1 – Channel Interrupt Enabled |
| <div style="text-align: center;">0</div> Channel Interrupt Status | 0 – Interrupt Not Asserted 1 – Interrupt Asserted |

TPU function svmStdDt_bottom generates an interrupt when the current values of *Ualfa*, *Ubeta*, *T* and *prescaler* have been read by the TPU and indicates to the CPU that it can write new variables. The CPU program can either wait for this interrupt to occur, or poll the *LD_OK* bit to check it has cleared. The interrupt is generated at each reload by one of the bottom channels. The top channels do not generate any interrupts.

Table 7. svmStdDt_top and svmStdDt_bottom Parameter RAM

| Channel | Parameter | 15 | 14 | 13 | 12 | 11 | 10 | 9 | 8 | 7 | 6 | 5 | 4 | 3 | 2 | 1 | 0 | |
|---------------------------|-----------|-----------------|----|----|----|----|----|---|---|---|---|---|---|---|---|---|---|--|
| Phase A top channel | 0 | htA | | | | | | | | | | | | | | | | |
| | 1 | HLtime_AT | | | | | | | | | | | | | | | | |
| | 2 | bottom_chan_A | | | | | | | | | | | | | | | | |
| | 3 | currentA | | | | | | | | | | | | | | | | |
| | 4 | LD_OK | | | | | | | | | | | | | | | | |
| | 5 | Sector | | | | | | | | | | | | | | | | |
| | 6 | | | | | | | | | | | | | | | | | |
| | 7 | fault_pinstate | | | | | | | | | | | | | | | | |
| Phase A bottom channel | 0 | LHtime_AB | | | | | | | | | | | | | | | | |
| | 1 | HLtime_AB | | | | | | | | | | | | | | | | |
| | 2 | UA | | | | | | | | | | | | | | | | |
| | 3 | UB | | | | | | | | | | | | | | | | |
| | 4 | Ualfa | | | | | | | | | | | | | | | | |
| | 5 | Ubeta | | | | | | | | | | | | | | | | |
| | 6 | UA3 | | | | | | | | | | | | | | | | |
| | 7 | | | | | | | | | | | | | | | | | |
| Phase B top channel | 0 | htB | | | | | | | | | | | | | | | | |
| | 1 | HLtime_BT | | | | | | | | | | | | | | | | |
| | 2 | bottom_chan_B | | | | | | | | | | | | | | | | |
| | 3 | currentB | | | | | | | | | | | | | | | | |
| | 4 | SQRT3 | | | | | | | | | | | | | | | | |
| | 5 | sync_presc_addr | | | | | | | | | | | | | | | | |
| | 6 | | | | | | | | | | | | | | | | | |
| | 7 | | | | | | | | | | | | | | | | | |
| Phase B bottom channel | 0 | LHtime_BB | | | | | | | | | | | | | | | | |
| | 1 | HLtime_BB | | | | | | | | | | | | | | | | |
| | 2 | T_copy | | | | | | | | | | | | | | | | |
| | 3 | dec | | | | | | | | | | | | | | | | |
| | 4 | T | | | | | | | | | | | | | | | | |
| | 5 | prescaler | | | | | | | | | | | | | | | | |
| | 6 | | | | | | | | | | | | | | | | | |
| | 7 | | | | | | | | | | | | | | | | | |
| Phase C top channel | 0 | htC | | | | | | | | | | | | | | | | |
| | 1 | HLtime_CT | | | | | | | | | | | | | | | | |
| | 2 | bottom_chan_C | | | | | | | | | | | | | | | | |
| | 3 | currentC | | | | | | | | | | | | | | | | |
| | 4 | prsc_copy | | | | | | | | | | | | | | | | |
| | 5 | center_time | | | | | | | | | | | | | | | | |
| | 6 | | | | | | | | | | | | | | | | | |
| | 7 | | | | | | | | | | | | | | | | | |

Table 7. svmStdDt_top and svmStdDt_bottom Parameter RAM

| Channel | Parameter | 15 | 14 | 13 | 12 | 11 | 10 | 9 | 8 | 7 | 6 | 5 | 4 | 3 | 2 | 1 | 0 | |
|---------------------------|-----------|-----------|----|----|----|----|----|---|---|---|---|---|---|---|---|---|---|--|
| Phase C bottom channel | 0 | LHtime_CB | | | | | | | | | | | | | | | | |
| | 1 | HLtime_CB | | | | | | | | | | | | | | | | |
| | 2 | min_ht | | | | | | | | | | | | | | | | |
| | 3 | max_ht | | | | | | | | | | | | | | | | |
| | 4 | DT | | | | | | | | | | | | | | | | |
| | 5 | MPW | | | | | | | | | | | | | | | | |
| | 6 | | | | | | | | | | | | | | | | | |
| | 7 | | | | | | | | | | | | | | | | | |

Table 8. svmStdDt_top and svmStdDt_bottom parameter description

| Parameter | Format | Description |
|--|-------------------------|--|
| Parameters written by CPU | | |
| Ualfa, Ubeta | 16-bit fractional | Stator Reference Voltage Vector components |
| currentA | 0 or 1 | 0 ... positive current on phase A 1 ... negative current on phaseA |
| currentB | 0 or 1 | 0 ... positive current on phase B 1 ... negative current on phaseB |
| currentC | 0 or 1 | 0 ... positive current on phase C 1 ... negative current on phaseC |
| T | 16-bit unsigned integer | PWM period in number of TCR1 TPU cycles |
| prescaler | 16-bit unsigned integer | The number of PWM periods per reload of new values |
| DT | 16-bit unsigned integer | Dead-time in number of TCR1 TPU cycles |
| MPW | 16-bit unsigned integer | Minimum pulse width in number of TCR1 TPU cycles. See Performance for details. |
| SQRT3 | 16-bit fractional | $\sqrt{3}/2 = 0.866 = \$6EDA$ constant |
| sync_presc_addr | 8-bit unsigned integer | address of synchronization channel <i>prescaler</i> parameter: $\$X4$, where X is synchronization channel number. \$0 if no synchronization channel is used. |
| Parameters written by both TPU and CPU | | |
| LD_OK | 1-bit | 0 ... CPU can update variables 1 ... TPU can read variables CPU sets 1, TPU sets 0 |
| Parameters written by TPU | | |

Table 8. svmStdDt_top and svmStdDt_bottom parameter description

| Parameter | Format | Description |
|---|-------------------------|---|
| Sector | 16-bit unsigned integer | The position of Stator Reference Voltage Vector in a sector. The Sector can be 1, 2, 3, 4, 5 or 6 |
| fault_pinstate | 0 or 1 | If fault channel is used, state of fault pin: 0 ... low 1 ... high |
| Other parameters are just for TPU function inner use. | | |

Performance

Table 9. svmStdDt_top State Statistics

| State | Max IMB Clock Cycles | RAM Accesses by TPU |
|-------|----------------------|---------------------|
| HL | 2 | 1 |
| LH_C5 | 36 | 10 |

Table 10. svmStdDt_bottom State Statistics

| State | Max IMB Clock Cycles | RAM Accesses by TPU |
|--------|----------------------|---------------------|
| INIT | 108 | 32 |
| STOP | 38 | 0 |
| LH | 2 | 1 |
| HL | 6 | 1 |
| LH_RLD | 44 | 16 |
| C1 | 48 | 3 |
| C2 | 48 | 4 |
| C3 | 50 | 3 |
| C4 | 48 | 8 |

NOTE: Execution times do not include the time slot transition time (TST = 10 or 14 IMB clocks)

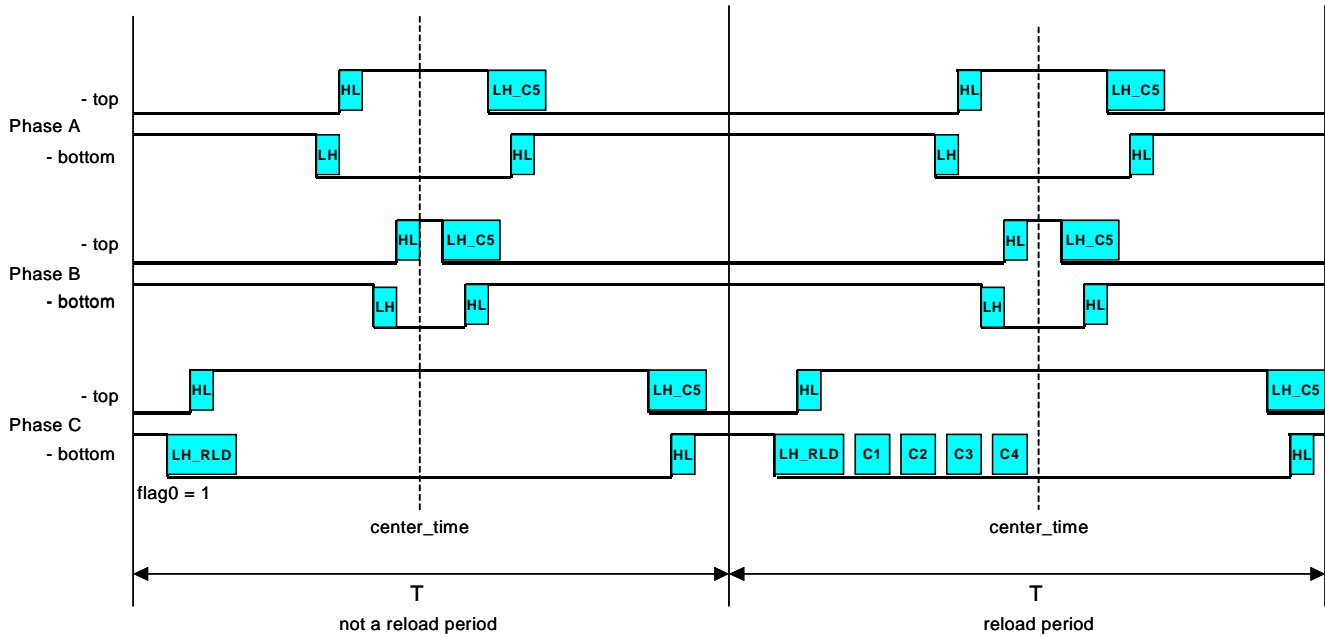

Figure 4. svmStdDt_top and svmStdDt_bottom timing

NOTE: The bottom channel with longest momentary low-time is marked by a flag0 and runs the LH_RLD and C1, C2, C3, C4 states.

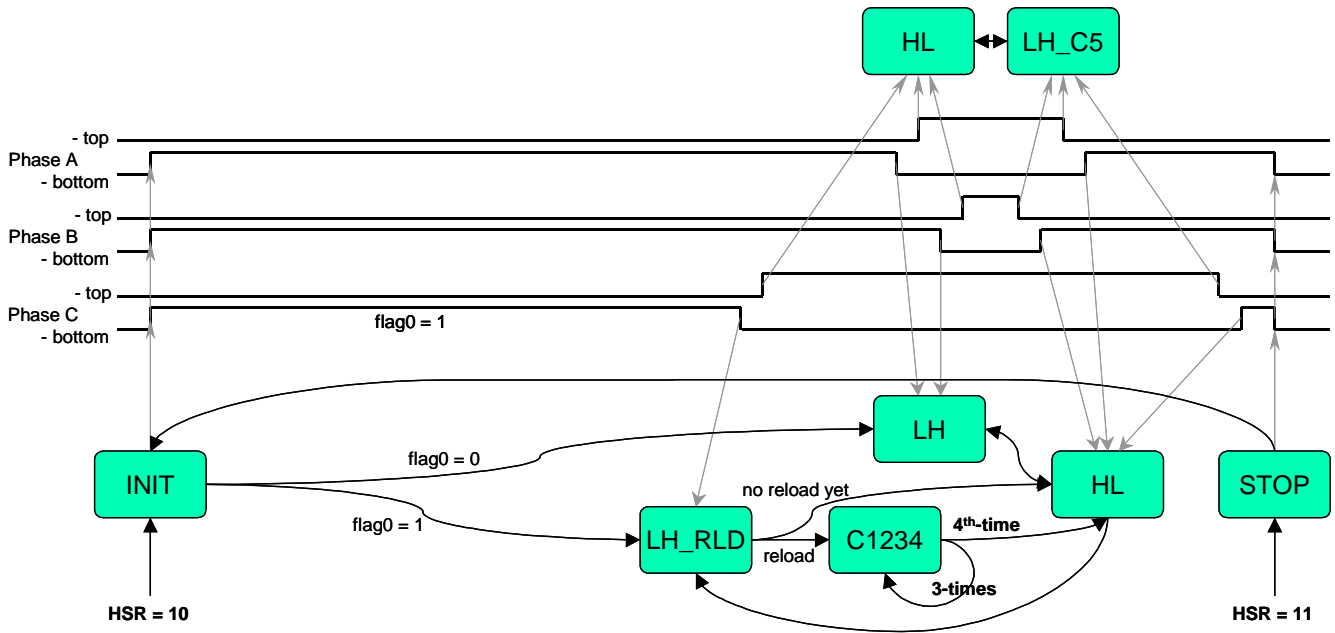

Figure 5. svmStdDt_top and svmStdDt_bottom state diagram

Minimum Pulse Width

The TPU cannot generate PWM signals with duty cycle ratios very close to 0% or 100%. The minimum pulse width that the TPU can be guaranteed to correctly generate is determined by the TPU function itself and by the activity on the other channels. When the TPU function is requested to generate a narrower pulse a collision can occur. To prevent this, the parameter *MPW* (minimum pulse width) is introduced. The TPU functions *svmStdDt_top* and *svmStdDt_bottom* limit the narrowest generated pulse widths to *MPW*. The CPU program should check, and limit, the maximum amplitude of the Stator Reference Voltage Vector before decomposition to $u_{\hat{a}}$, $u_{\hat{b}}$ components. The maximum amplitude of the Stator Reference Voltage Vector should be less than

$$1 - \frac{2(MPW + 2DT)}{T}$$

If this is not the case, the TPU function will start to limit the minimum pulse widths to *MPW* to prevent a collision, and the duty cycle ratio traces will be deformed as shown on [Figure 6](#).

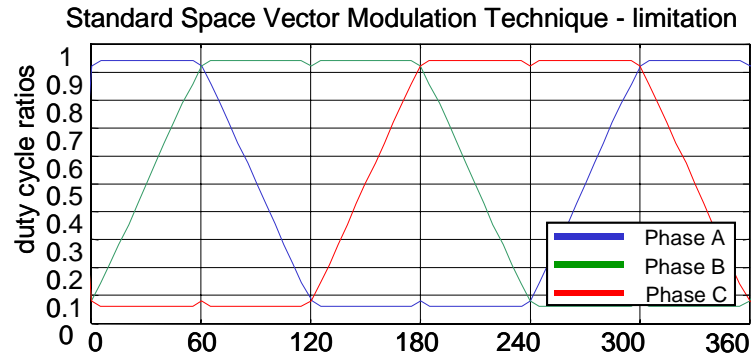

Figure 6. Effect of limitation

The *MPW* is written by the CPU. The *MPW* depends on the whole TPU unit configuration, especially the lengths of the longest states of other functions, and their priorities, running on the same TPU. The *MPW* has to be correctly calculated at the time the whole TPU unit is configured.

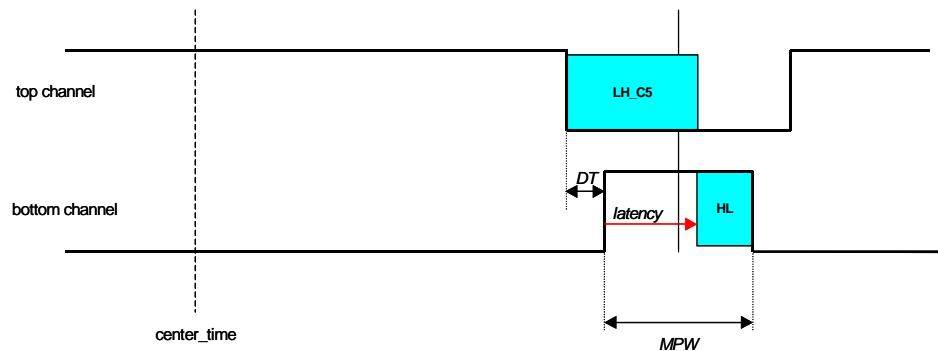

Figure 7. Timing of the worst case

When *svmStdDt_top* and *svmStdDt_bottom* are running alone on one TPU, the minimum pulse width can be calculated according to **Figure 7**. This illustrates the worst case timing. The bottom channel low to high transition runs the HL state that sets the following high to low transition. The HL state lasts 6 IMB clock cycles (see **Table 10**). Each state is preceded by the Time Slot Transition (TST), which takes 10 IMB clock cycles. So the time necessary to set the next transition on the bottom channel is 16 IMB clock cycles. In addition, there is a latency between the low to high transition and the start of the HL state. The top channel state LH_C5, which is serviced at the time, causes the latency. The LH_C5 state lasts 36 IMB clock cycles (see **Table 9**). Its time slot transition is

10 IMB clock cycles. The service starts immediately after the top channel high to low transition, which occurs at a period of DT before the bottom channel low to high transition (see **Figure 7**), so that the latency is 36 IMB clock cycles + 10 IMB clock cycles – DT . The $svmStdDt$ functions are designed so that no other $svmStdDt$ state can request service at this time. The MPW , in the case when only $svmStdDt$ functions are running on one TPU, is then

$$\begin{aligned} & \text{latency} + 16 \text{ IMB clock cycles} = \\ & = 36 \text{ IMB clock cycles} + 10 \text{ IMB clock cycles} - DT + 16 \text{ IMB clock cycles} = \\ & = 62 \text{ IMB clock cycles} - DT \end{aligned}$$

and is a minimum at least 16 IMB clock cycles (when latency = 0).

Note that the MPW , as well as the DT , are not entered into the parameter RAM in IMB clock cycles, but in TCR1 clock cycles. It is recommended for the $svmStdDt$ function to configure the TCR1 clock to its maximum speed, which is the IMB clock divided by 2. In this case the $MPW = 31 - DT$, with a minimum value of 8.

When other functions are running together, on the same TPU, with the $svmStdDt$ functions, the latency could be lengthened. To maintain sufficiently high performance of $svmStdDt$, it is recommended that the following rules are followed when configuring the TPU:

- assign $svmStdDt$ PWM channels high priority
- assign $svmStdDt$ PWM functions on low channel numbers so that no other function with high priority is assigned a channel with a lower number

In this instance, one of the two worst case timing cases can happen. These are illustrated in **Figure 8** and **Figure 9**. Which case occurs depends on the DT .

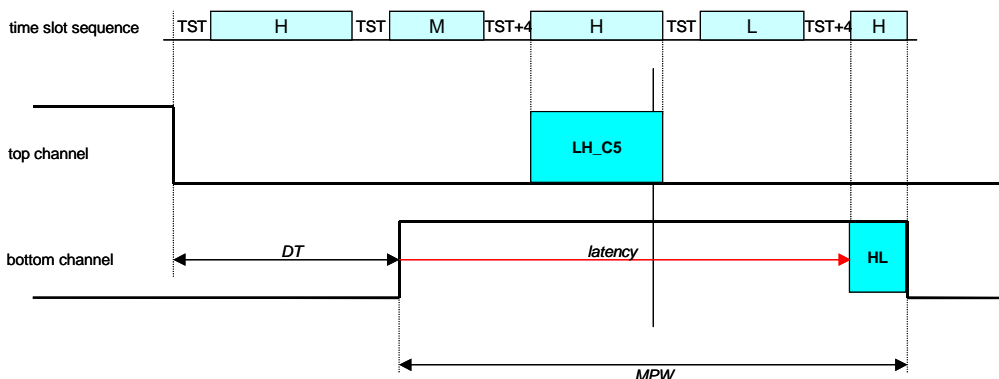

Figure 8. Worst case timing – case one

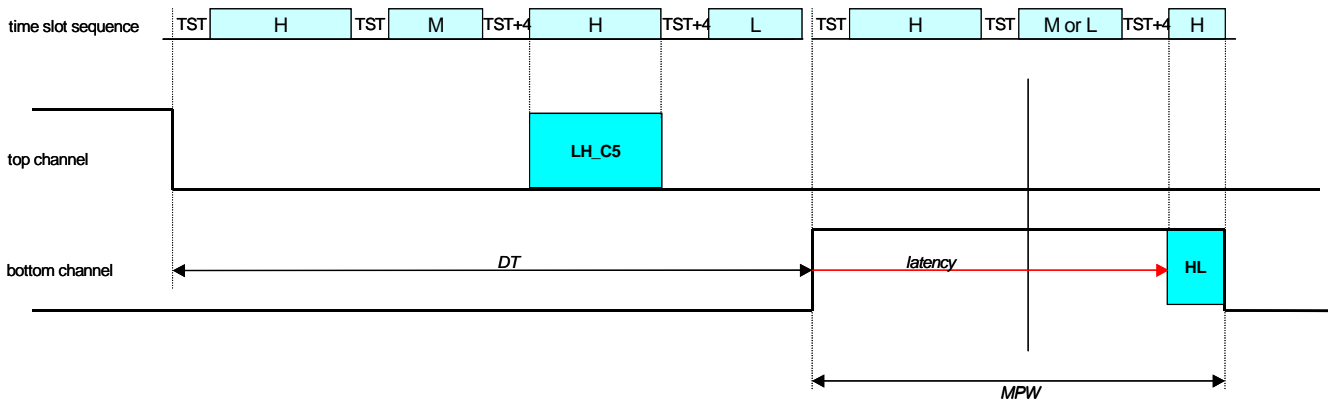

Figure 9. Worst case timing – case two

The time slot sequences at the top of both figures shows when a state of a high (H), middle (M) or low (L) priority is serviced in the worst case. To calculate the *MPW* follow these steps:

- Get the lengths of the longest states.
 - It is necessary to know the lengths of the longest states within all functions of each priority group. The initialization states are not considered – only the running states. Let's denote *H* as the time period of the longest state within all functions running on high priority (Do not consider *svmStdDt* functions). Let's denote *M* as the time period of the longest state within all functions running on middle priority and *L* as the time period of the longest state within all functions running on low priority.
- Decide which timing case can occur.
 - The first case can occur when the *DT* (in IMB clock cycles) is less than $TST + H + TST + M + TST+4 + LH_C5 + TST+4 + L$ (see [Figure 9](#)) that is $4 * TST + 8 + H + M + L + LH_C5$ that is $84 + H + M + L$ IMB clock cycles.

if *DT* (in IMB clock cycles) < $84 + H + M + L$
then – case one
else – case two
- Calculate *MPW* based on case one or case two.
 - In **case one** the *MPW* is (according to [Figure 8](#))
 $TST + H + TST + M + TST+4 + LH_C5 + TST + L + TST+4 + HL - DT$
 that is $100 + H + M + L - DT$ IMB clock cycles.

$$MPW \text{ (in IMB clock cycles)} = 100 + H + M + L - DT$$

- In **case two** the MPW is (according to **Figure 9**)
 $TST + H + TST + \max(M,L) + TST+4 + HL$
 that is $40 + H + \max(M,L)$ IMB clock cycles.

$$MPW \text{ (in IMB clock cycles)} = 40 + H + \max(M,L)$$

- Convert *MPW* in IMB clock cycles to *MPW* in TCR1 clock cycles based on TCR1 prescaler settings.

When there are no channels of middle or low priority, simply leave out all the *H* or *L* and the following TST or TST+4 from the formulas.

When the recommended configuration rules are not adhered to, the timing of the worst case is much more complicated. It requires some familiarity with the details of the TPU priority scheme. In this case, the Worst-Case Latency (WCL), which is automatically calculated by the MPC500_Quick_Start Graphical Configuration Tool, can serve as a good approximation. This is always longer than the real-case is. Let the WCL be calculated after the configuration of the TPU channels and then find the longest WCL value within all the *svmStdDt* PWM channels. Convert the number, from IMB clock cycles to TCR1 clock cycles, to get the *MPW*.

**Synchronization
 signal for Standard
 Space Vector
 Modulation with
 Dead-Time
 Correction
 (svmStdDt_sync)**

The *svmStdDt_sync* TPU function uses information obtained from *svmStdDt* PWM functions, the actual PWM center times and the PWM periods. This allows a signal to be generated, which tracks the changes in the PWM period and is always synchronized with the PWM. The synchronization signal is a positive pulse generated repeatedly after the *prescaler* or *presc_copy* PWM periods (see next paragraph). The low to high transition of the pulse can be adjusted by a parameter, either negative or positive, to go a number of TCR1 TPU cycles before or after the PWM period center time. The pulse width *pw* is another synchronization signal parameter.

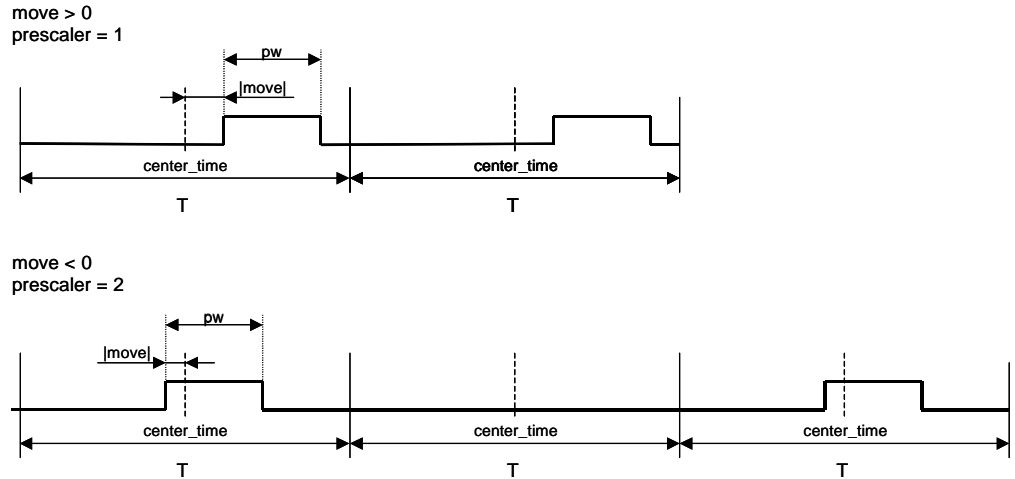

Figure 10. Synchronization signal adjustment examples

Synchronized Change of PWM Prescaler And Synchronization Signal Prescaler

The `svmStdDt_sync` TPU function actually uses the `presc_copy` parameter instead of the `prescaler` parameter. The `prescaler` parameter holds the prescaler value that is copied to the `presc_copy` by the `svmStdDt_bottom` function at the time the PWM parameters are reloaded. This ensures that new prescaler values for the PWM signals, as well as the synchronization signal, are applied at the same time. Write the synchronization signal `prescaler` parameter address to the `sync_presc_addr` parameter to enable this mechanism. Write 0 to disable it, and remember to set the synchronization signal `presc_copy` parameter instead of the `prescaler` parameter in this case.

Host Interface

| | | | |
|---|----------------|--|-----------------------------|
|  | Written By CPU |  | Written by both CPU and TPU |
|  | Written By TPU |  | Not Used |

Table 11. `svmStdDt_sync` Control Bits

| Name | Options |
|---|---|
| <div style="display: flex; justify-content: space-around; width: 100px;"> 3210 </div> <div style="display: flex; align-items: center;"> <div style="border: 1px solid black; width: 20px; height: 20px; margin-right: 5px;"></div> <div style="border: 1px solid black; width: 20px; height: 20px; margin-right: 5px;"></div> <div style="border: 1px solid black; width: 20px; height: 20px; margin-right: 5px;"></div> <div style="border: 1px solid black; width: 20px; height: 20px;"></div> </div> Channel Function Select | <code>svmStdDt_sync</code> function number (Assigned during assembly the DPTRAM code from library TPU functions) |
| <div style="display: flex; justify-content: space-around; width: 40px;"> 10 </div> <div style="display: flex; align-items: center;"> <div style="border: 1px solid black; width: 20px; height: 20px; margin-right: 5px;"></div> <div style="border: 1px solid black; width: 20px; height: 20px;"></div> </div> Channel Priority | 00 – Channel Disabled 01 – Low Priority 10 – Middle Priority 11 – High Priority |

Table 11. svmStdDt_sync Control Bits

| Name | Options |
|--|---|
| <div style="display: flex; align-items: center;"> <div style="margin-right: 10px;"> <div style="display: flex; justify-content: space-around; width: 20px;"> 10 </div> <div style="border: 1px solid black; width: 15px; height: 15px; margin: 2px;"></div> <div style="border: 1px solid black; width: 15px; height: 15px; margin: 2px;"></div> </div> <div>Host Service Bits (HSR)</div> </div> | 00 – No Host Service Request 01 – Not used 10 – Initialization 11 – Not used |
| <div style="display: flex; align-items: center;"> <div style="margin-right: 10px;"> <div style="display: flex; justify-content: space-around; width: 20px;"> 10 </div> <div style="background-color: green; width: 15px; height: 15px; margin: 2px;"></div> <div style="background-color: green; width: 15px; height: 15px; margin: 2px;"></div> </div> <div>Host Sequence Bits (HSQ)</div> </div> | xx – Not used |
| <div style="display: flex; align-items: center;"> <div style="margin-right: 10px;"> <div style="display: flex; justify-content: space-around; width: 20px;"> 0 </div> <div style="border: 1px solid black; width: 15px; height: 15px; margin: 2px;"></div> </div> <div>Channel Interrupt Enable</div> </div> | 0 – Channel Interrupt Disabled 1 – Channel Interrupt Enabled |
| <div style="display: flex; align-items: center;"> <div style="margin-right: 10px;"> <div style="display: flex; justify-content: space-around; width: 20px;"> 0 </div> <div style="background-color: blue; width: 15px; height: 15px; margin: 2px;"></div> </div> <div>Channel Interrupt Status</div> </div> | 0 – Interrupt Not Asserted 1 – Interrupt Asserted |

TPU function svmStdDt_sync generates an interrupt after each low to high transition.

Table 12. svmStdDt_sync Parameter RAM

| Channel | Parameter | 15 | 14 | 13 | 12 | 11 | 10 | 9 | 8 | 7 | 6 | 5 | 4 | 3 | 2 | 1 | 0 | |
|-------------------------|-----------|------------|----|----|----|----|----|---|---|---|---|---|---|---|---|---|---|--|
| Synchronization channel | 0 | move | | | | | | | | | | | | | | | | |
| | 1 | pw | | | | | | | | | | | | | | | | |
| | 2 | prescaler | | | | | | | | | | | | | | | | |
| | 3 | presc_copy | | | | | | | | | | | | | | | | |
| | 4 | time | | | | | | | | | | | | | | | | |
| | 5 | dec | | | | | | | | | | | | | | | | |
| | 6 | T_copy | | | | | | | | | | | | | | | | |
| | 7 | | | | | | | | | | | | | | | | | |

Table 13. svmStdDt_sync parameter description

| Parameter | Format | Description |
|---------------------------|-------------------------|--|
| Parameters written by CPU | | |
| move | 16-bit signed integer | The number of TCR1 TPU cycles to forego (negative) or come after (positive) the PWM period center time |
| pw | 16-bit unsigned integer | Synchronization pulse width in number of TCR1 TPU cycles. |

Table 13. svmStdDt_sync parameter description

| Parameter | Format | Description |
|---|-------------------------|---|
| prescaler | 16-bit unsigned integer | The number of PWM periods per synchronization pulse – use in case of synchronized prescalers change |
| presc_copy | 16-bit unsigned integer | The number of PWM periods per synchronization pulse – use in case of asynchronized prescalers change |
| Parameters written by TPU | | |
| Other parameters are just for TPU function inner use. | | |

Performance

There is one limitation. The absolute value of parameter *move* has to be less than a quarter of the PWM period *T*.

$$|move| < \frac{T}{4}$$

Table 14. svmStdDt_sync State Statistics

| State | Max IMB Clock Cycles | RAM Accesses by TPU |
|-------|----------------------|---------------------|
| INIT | 12 | 5 |
| S1 | 12 | 6 |
| S2 | 8 | 3 |
| S3 | 16 | 7 |

NOTE: Execution times do not include the time slot transition time ($TST = 10$ or 14 IMB clocks)

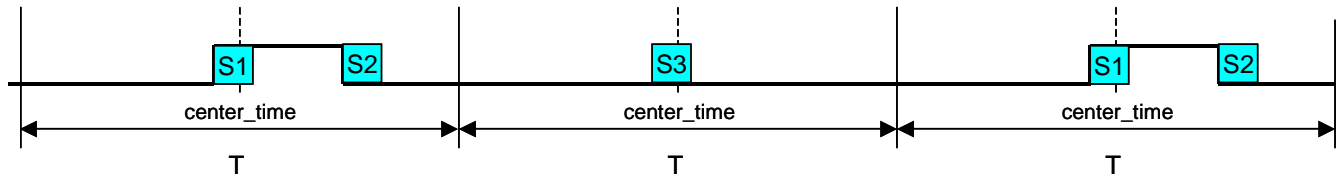

Figure 11. svmStdDt_sync timing

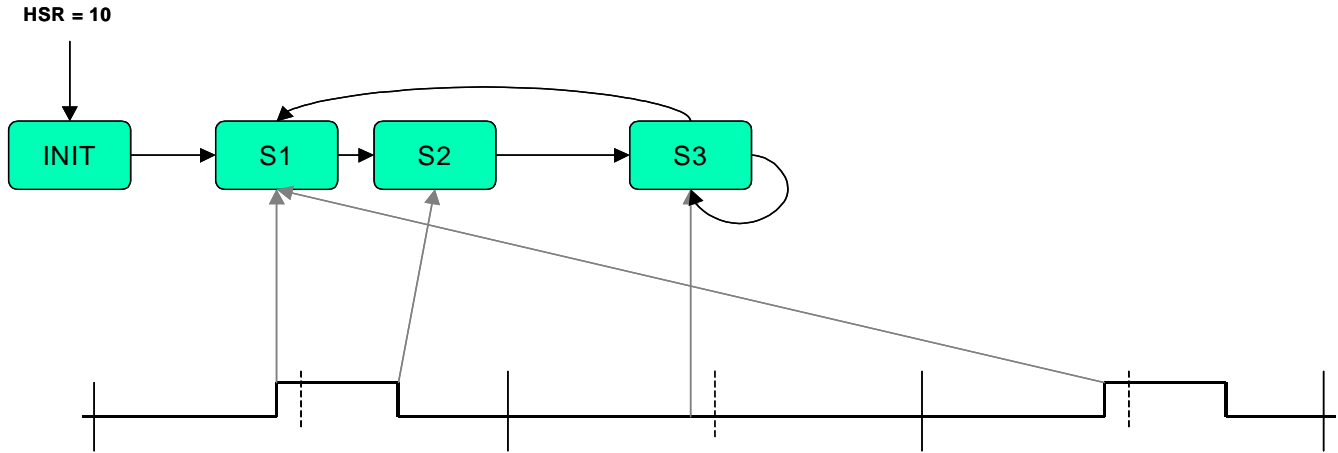
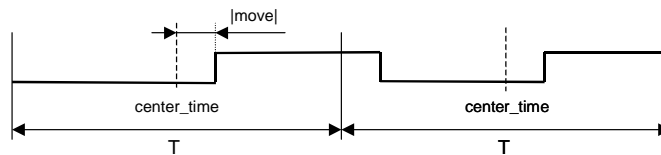

Figure 12. svmStdDt_sync state diagram

Resolver Reference Signal for Standard Space Vector Modulation with Dead-Time Correction (svmStdDt_res)

The svmStdDt_res TPU function uses information read from the svmStdDt PWM functions, the actual PWM center times and the PWM periods. This allows a signal to be generated, which tracks the changes of the PWM period and is always synchronized with the PWM. The resolver reference signal is a 50% duty-cycle signal with a period equal to *prescaler* or synchronization channel *presc_copy* PWM periods (see next paragraph). The low to high transition of the pulse can be adjusted by a parameter, either negative or positive, to go a number of TCR1 TPU cycles before or after the PWM period center time.

move > 0
prescaler = 1



move < 0
prescaler = 2

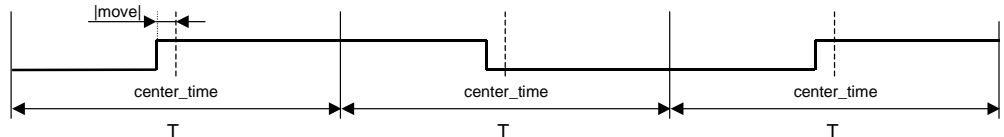

Figure 13. Resolver reference signal adjustment examples

Synchronized Change of PWM Prescaler And Resolver Reference Signals Prescaler

The svmStdDt_res TPU function can inherit the Synchronization Signal prescaler that is synchronously changed with the PWM prescaler. Write the synchronization signals *presc_copy* parameter address to the *presc_addr* parameter to enable this mechanism. Write 0 to disable it, and in this case set the *prescaler* parameter to directly specify prescaler value.

Host Interface





| | |
|--|--|
|  Written By CPU |  Written by both CPU and TPU |
|  Written By TPU |  Not Used |

Table 15. svmStdDt_res Control Bits







| Name | Options |
|---|---|
| <div style="display: flex; justify-content: space-around; width: 100px;"> 3210 </div>  Channel Function Select | svmStdDt_res function number (Assigned during assembly the DPTRAM code from library TPU functions) |
| <div style="display: flex; justify-content: space-around; width: 40px;"> 10 </div>  Channel Priority | 00 – Channel Disabled 01 – Low Priority 10 – Middle Priority 11 – High Priority |
| <div style="display: flex; justify-content: space-around; width: 40px;"> 10 </div>  Host Service Bits (HSR) | 00 – No Host Service Request 01 – Not used 10 – Initialization 11 – Not used |
| <div style="display: flex; justify-content: space-around; width: 40px;"> 10 </div>  Host Sequence Bits (HSQ) | xx – Not used |
| <div style="display: flex; justify-content: space-around; width: 40px;"> 0 </div>  Channel Interrupt Enable | x – Not used |
| <div style="display: flex; justify-content: space-around; width: 40px;"> 0 </div>  Channel Interrupt Status | x – Not used |

Table 16. svmStdDt_res Parameter RAM

| Channel | Parameter | 15 | 14 | 13 | 12 | 11 | 10 | 9 | 8 | 7 | 6 | 5 | 4 | 3 | 2 | 1 | 0 | |
|----------|-----------|------------|----|----|----|----|----|---|---|---|---|---|---|---|---|---|---|--|
| Resolver | 0 | move | | | | | | | | | | | | | | | | |
| | 1 | | | | | | | | | | | | | | | | | |
| | 2 | presc_addr | | | | | | | | | | | | | | | | |
| | 3 | prescaler | | | | | | | | | | | | | | | | |
| | 4 | time | | | | | | | | | | | | | | | | |
| | 5 | dec | | | | | | | | | | | | | | | | |
| | 6 | T_copy | | | | | | | | | | | | | | | | |
| | 7 | | | | | | | | | | | | | | | | | |

Table 17. svmStdDt_res parameter description

| Parameter | Format | Description |
|---|--------------------------------|--|
| Parameters written by CPU | | |
| move | 16-bit signed integer | The number of TCR1 TPU cycles to forego (negative) or come after (positive) the PWM period center time |
| presc_addr | 16-bit unsigned integer | \$00X6, where X is a number of Synchronization Signal channel, to inherit Sync. channel prescaler or \$0000 to enable direct specification of prescaler value in prescaler parameter |
| prescaler | 1, 2, 4, 6, 8, 10, 12, 14, ... | The number of PWM periods per synchronization pulse – use when apresc_addr = 0 |
| Parameters written by TPU | | |
| Other parameters are just for TPU function inner use. | | |

Performance

There is one limitation. The absolute value of parameter *move* has to be less than a quarter of the PWM period *T*.

$$|move| < \frac{T}{4}$$

Table 18. svmStdDt_res State Statistics

| State | Max IMB Clock Cycles | RAM Accesses by TPU |
|-------|----------------------|---------------------|
| INIT | 12 | 5 |

Table 18. svmStdDt_res State Statistics

| State | Max IMB Clock Cycles | RAM Accesses by TPU |
|-------|----------------------|---------------------|
| S1 | 26 | 9 |
| S3 | 18 | 7 |

NOTE: Execution times do not include the time slot transition time ($TST = 10$ or 14 IMB clocks)

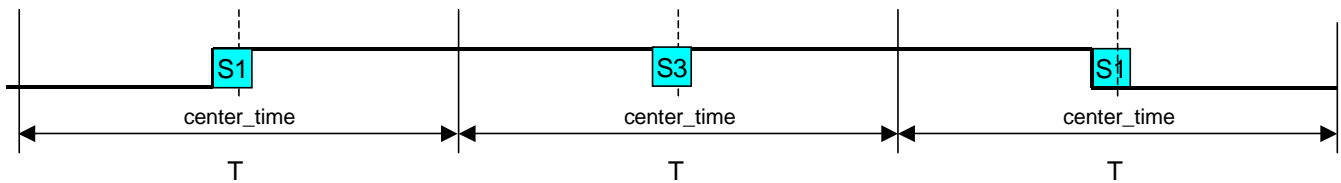

Figure 14. svmStdDt_res timing

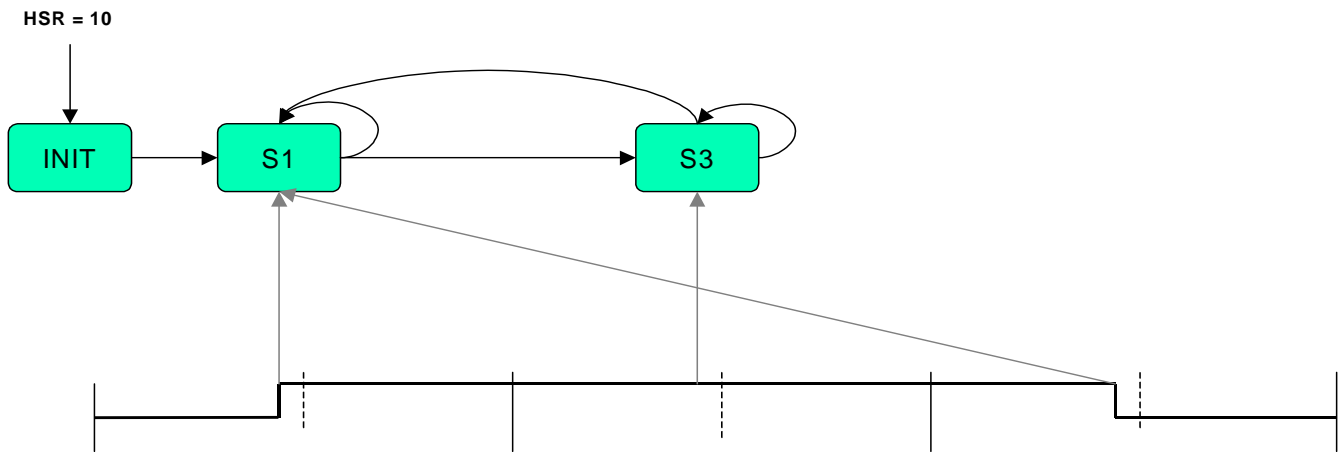

Figure 15. svmStdDt_res state diagram

Fault Input for Standard Space Vector Modulation with Dead-Time Correction (svmStdDt_fault)

The svmStdDt_fault is an input TPU function that monitors the pin, and if a high to low transition occurs, immediately sets all PWM channels low and cancels all further transitions on them. The PWM channels, as well as the synchronization and resolver reference signal channels (if used), have to be initialized again to start them running.

The function returns the actual pinstate as a value of 0 (low) or 1 (high) in the parameter *fault_pinstate*. The parameter is placed on the Phase A – top channel to keep the fault channel parameter space free.

Host Interface

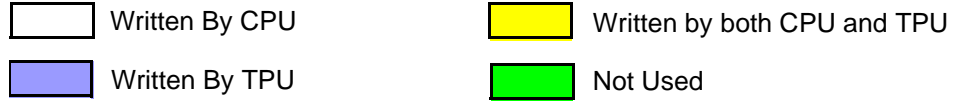

Table 19. svmStdDt_fault Control Bits

| Name | Options |
|---|---|
| <div style="display: flex; justify-content: space-around; width: 100px;"> 3210 </div> <div style="display: flex; align-items: center;"> <div style="border: 1px solid black; width: 15px; height: 15px; margin-right: 5px;"></div> <div style="border: 1px solid black; width: 15px; height: 15px; margin-right: 5px;"></div> <div style="border: 1px solid black; width: 15px; height: 15px; margin-right: 5px;"></div> <div style="border: 1px solid black; width: 15px; height: 15px;"></div> </div> Channel Function Select | svmStdDt_fault function number (Assigned during assembly the DPTRAM code from library TPU functions) |
| <div style="display: flex; justify-content: space-around; width: 100px;"> 10 </div> <div style="display: flex; align-items: center;"> <div style="border: 1px solid black; width: 15px; height: 15px; margin-right: 5px;"></div> <div style="border: 1px solid black; width: 15px; height: 15px;"></div> </div> Channel Priority | 00 – Channel Disabled 01 – Low Priority 10 – Middle Priority 11 – High Priority |
| <div style="display: flex; justify-content: space-around; width: 100px;"> 10 </div> <div style="display: flex; align-items: center;"> <div style="border: 1px solid black; width: 15px; height: 15px; margin-right: 5px;"></div> <div style="border: 1px solid black; width: 15px; height: 15px;"></div> </div> Host Service Bits (HSR) | 00 – No Host Service Request 01 – Not used 10 – Initialization 11 – Not used |
| <div style="display: flex; justify-content: space-around; width: 100px;"> 10 </div> <div style="display: flex; align-items: center;"> <div style="background-color: lime; width: 15px; height: 15px; margin-right: 5px;"></div> <div style="background-color: lime; width: 15px; height: 15px;"></div> </div> Host Sequence Bits (HSQ) | xx – Not used |
| <div style="display: flex; justify-content: space-around; width: 100px;"> 0 </div> <div style="display: flex; align-items: center;"> <div style="border: 1px solid black; width: 15px; height: 15px; margin-right: 5px;"></div> </div> Channel Interrupt Enable | 0 – Channel Interrupt Disabled 1 – Channel Interrupt Enabled |
| <div style="display: flex; justify-content: space-around; width: 100px;"> 0 </div> <div style="display: flex; align-items: center;"> <div style="background-color: lightblue; width: 15px; height: 15px; margin-right: 5px;"></div> </div> Channel Interrupt Status | 0 – Interrupt Not Asserted 1 – Interrupt Asserted |

TPU function svmStdDt_fault generates an interrupt when a high to low transition appears.

Table 20. svmStdDt_fault Parameter RAM

| Channel | Parameter | 15 | 14 | 13 | 12 | 11 | 10 | 9 | 8 | 7 | 6 | 5 | 4 | 3 | 2 | 1 | 0 |
|-------------|-----------|----|----|----|----|----|----|---|---|---|---|---|---|---|---|---|---|
| Fault input | 0 | | | | | | | | | | | | | | | | |
| | 1 | | | | | | | | | | | | | | | | |
| | 2 | | | | | | | | | | | | | | | | |
| | 3 | | | | | | | | | | | | | | | | |
| | 4 | | | | | | | | | | | | | | | | |
| | 5 | | | | | | | | | | | | | | | | |
| | 6 | | | | | | | | | | | | | | | | |
| | 7 | | | | | | | | | | | | | | | | |

Table 21. svmStdDt_fault parameter description

| Parameter | Format | Description |
|---------------------------|--------|--|
| Parameters written by TPU | | |
| fault_pinstate | 0 or 1 | State of fault pin: 0 ... low 1 ... high |

Performance

Table 22. svmStdDt_fault State Statistics

| State | Max IMB Clock Cycles | RAM Accesses by TPU |
|----------|----------------------|---------------------|
| INIT | 8 | 2 |
| FAULT | 44 | 1 |
| NO_FAULT | 4 | 1 |

NOTE: Execution times do not include the time slot transition time (TST = 10 or 14 IMB clocks)

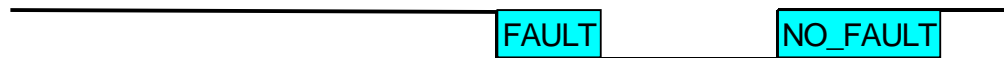

Figure 16. svmStdDt_fault timing

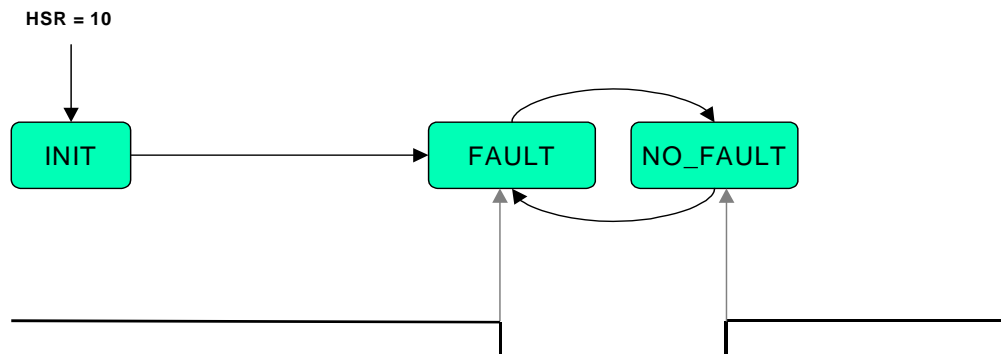

Figure 17. svmStdDt_fault state diagram

HOW TO REACH US:

USA/EUROPE/LOCATIONS NOT LISTED:

Motorola Literature Distribution
P.O. Box 5405
Denver, Colorado 80217
1-800-521-6274 or 480-768-2130

JAPAN:

Motorola Japan Ltd.
SPS, Technical Information Center
3-20-1, Minami-Azabu, Minato-ku
Tokyo 106-8573, Japan
81-3-3440-3569

ASIA/PACIFIC:

Motorola Semiconductors H.K. Ltd.
Silicon Harbour Centre
2 Dai King Street
Tai Po Industrial Estate
Tai Po, N.T., Hong Kong
852-26668334

HOME PAGE:

<http://motorola.com/semiconductors>



Information in this document is provided solely to enable system and software implementers to use Motorola products. There are no express or implied copyright licenses granted hereunder to design or fabricate any integrated circuits or integrated circuits based on the information in this document.

Motorola reserves the right to make changes without further notice to any products herein. Motorola makes no warranty, representation or guarantee regarding the suitability of its products for any particular purpose, nor does Motorola assume any liability arising out of the application or use of any product or circuit, and specifically disclaims any and all liability, including without limitation consequential or incidental damages. "Typical" parameters that may be provided in Motorola data sheets and/or specifications can and do vary in different applications and actual performance may vary over time. All operating parameters, including "Typicals", must be validated for each customer application by customer's technical experts. Motorola does not convey any license under its patent rights nor the rights of others. Motorola products are not designed, intended, or authorized for use as components in systems intended for surgical implant into the body, or other applications intended to support or sustain life, or for any other application in which the failure of the Motorola product could create a situation where personal injury or death may occur. Should Buyer purchase or use Motorola products for any such unintended or unauthorized application, Buyer shall indemnify and hold Motorola and its officers, employees, subsidiaries, affiliates, and distributors harmless against all claims, costs, damages, and expenses, and reasonable attorney fees arising out of, directly or indirectly, any claim of personal injury or death associated with such unintended or unauthorized use, even if such claim alleges that Motorola was negligent regarding the design or manufacture of the part.

MOTOROLA and the Stylized M Logo are registered in the US Patent and Trademark Office. All other product or service names are the property of their respective owners. Motorola, Inc. is an Equal Opportunity/Affirmative Action Employer.

© Motorola Inc. 2003

AN2530/D
Rev. 0
5/2003

**For More Information On This Product,
Go to: www.freescale.com**