

Wireless Bipolar Power Transistor, 15W

1.78 - 1.90 GHz

PH1819-15N

V2.00

Features

- NPN Silicon Microwave Power Transistor
- Designed for Linear Amplifier Applications
- Class AB: -34 dBc Typ 3rd IMD at 15 Watts PEP
- Class A: +48 dBm Typ 3rd Order Intercept Point
- Common Emitter Configuration
- Internal Input Impedance Matching
- Diffused Emitter Ballasting
- Gold Metallization System

Absolute Maximum Ratings at 25°C

Parameter	Symbol	Rating	Units
Collector-Base Voltage	V_{CBO}	60	V
Collector-Emitter Voltage	V_{CES}	60	V
Emitter-Base Voltage	V_{EBO}	3.0	V
Collector Current	I_C	2.0	A
Power Dissipation	P_D	58	W
Junction Temperature	T_J	200	°C
Storage Temperature	T_{STG}	-55 to +150	°C
Thermal Resistance	θ_{JC}	3.0	°C/W

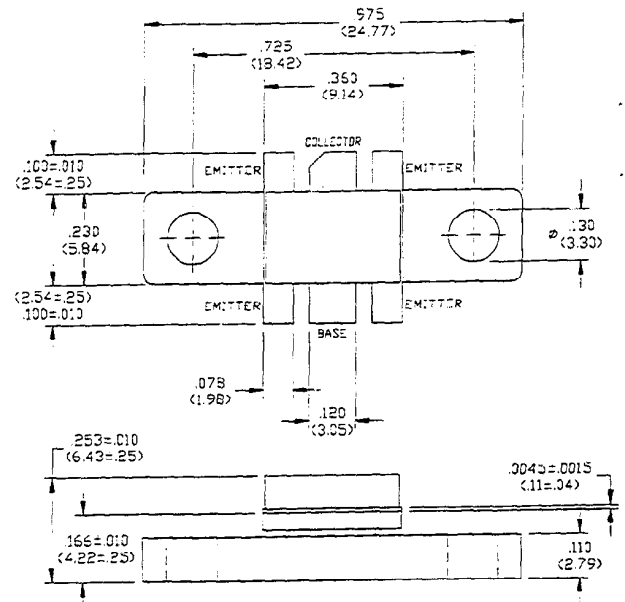

UNLESS OTHERWISE NOTED, TOLERANCES ARE INCHES = .005" (MILLIMETERS = .13MM)

Electrical Characteristics at 25°C

Parameter	Symbol	Min	Max	Units	Test Conditions
Collector-Emitter Breakdown Voltage	BV_{CES}	60	-	V	$I_C=10$ mA
Collector-Emitter Leakage Current	I_{CES}	-	1.0	mA	$V_{CE}=24$ V
Collector-Emitter Breakdown Voltage	BV_{CEO}	24	-	V	$I_C=10$ mA
Emitter-Base Breakdown Voltage	BV_{EBO}	3.0	-	V	$I_B=10$ mA
DC Forward Current Gain	h_{FE}	15	120	-	$V_{CE}=5$ V, $I_C=0.5$ A
Power Gain	G_p	7.0	-	dB	$V_{CC}=26$ V, $I_{CO}=25$ mA, $P_{OUT}=15$ W PEP, $F=1880$ MHz, $\Delta F=100$ kHz
Collector Efficiency	η_c	25	-	%	$V_{CC}=26$ V, $I_{CO}=25$ mA, $P_{OUT}=15$ W PEP, $F=1880$ MHz, $\Delta F=100$ kHz
Input Return Loss	RL	10	-	dB	$V_{CC}=26$ V, $I_{CO}=25$ mA, $P_{OUT}=15$ W PEP, $F=1880$ MHz, $\Delta F=100$ kHz
Load Mismatch Tolerance	VSWR-T	-	10:1	-	$V_{CC}=26$ V, $I_{CO}=25$ mA, $P_{OUT}=15$ W PEP, $F=1880$ MHz, $\Delta F=100$ kHz
3rd Order IMD	IMD ₃	-	-30	dBc	$V_{CC}=26$ V, $I_{CO}=25$ mA, $P_{OUT}=15$ W PEP, $F=1880$ MHz, $\Delta F=100$ kHz

Typical Optimum Device Impedances

F (MHz)	$Z_{IN}(\Omega)$	$Z_{LOAD}(\Omega)$
1780	10.5 + j12.3	1.6 - j1.9
1850	11.4 + j11	1.6 - j2.2
1880	11.9 + j6.2	1.6 - j2.5
1880	9.9 + j3.6	1.6 - j2.7
1900	8.8 + j1.9	1.4 - j2.7

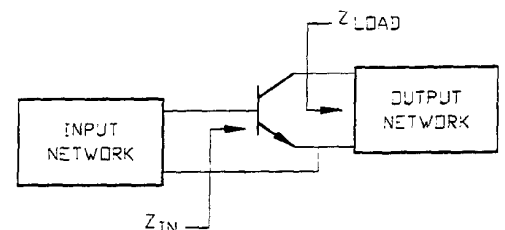

Specifications Subject to Change Without Notice.

M/A-COM, Inc.

North America: Tel. (800) 366-2266
Fax (800) 618-8883

Asia/Pacific: Tel. +81 (03) 3226-1671
Fax +81 (03) 3226-1451

Europe: Tel. +44 (1344) 869 595
Fax +44 (1344) 300 020

9-189

RF Test Fixture

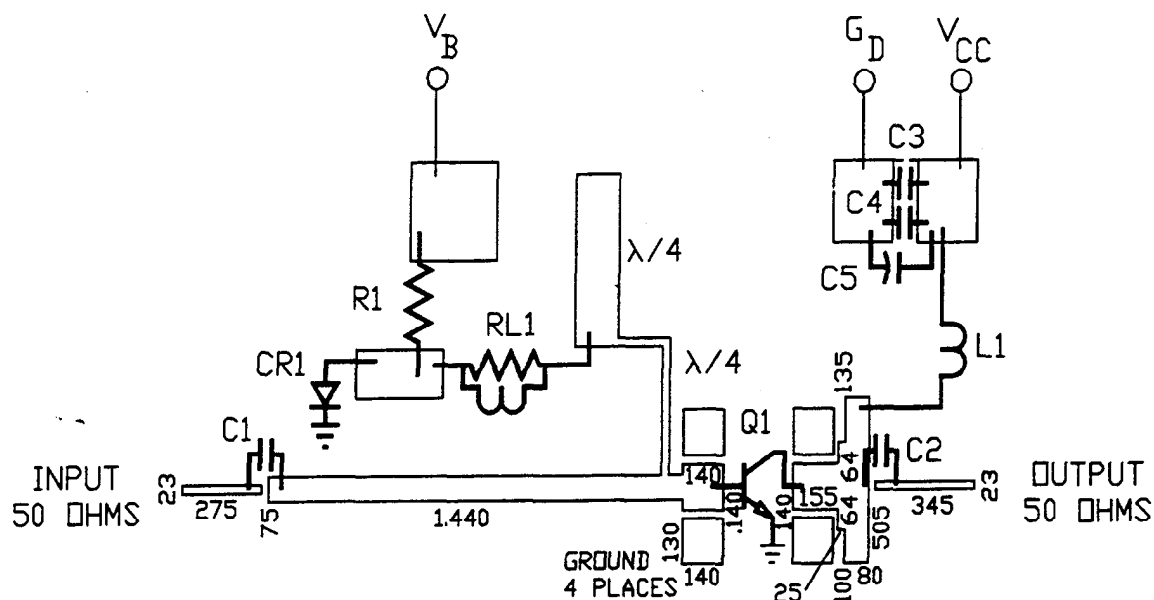

ARTWORK DIMENSIONS IN MILS

PARTS LIST

C1 C4	20pF ATC SIZE A CAPACITOR
C2	2.2pF ATC SIZE A CAPACITOR
C3	5000pF CHIP CAPACITOR
C5	50 VOLT 50μF ELECTROLYTIC CAPACITOR
CR1	1N5417 DIODE
L1	10 TURNS OF NO. 22 AWG ON .125" DIA
Q1	PH1819-15N
R1	4.7 OHM 1/4 WATT RESISTOR
RL1	13 TURNS OF NO. 26 AWG ON 3 OHM 1/4 WATT RESISTOR
BOARD TYPE	ROGERS 6010.5 .025" THICK, $E_R = 10.5$

Typical Broadband Performance Curves

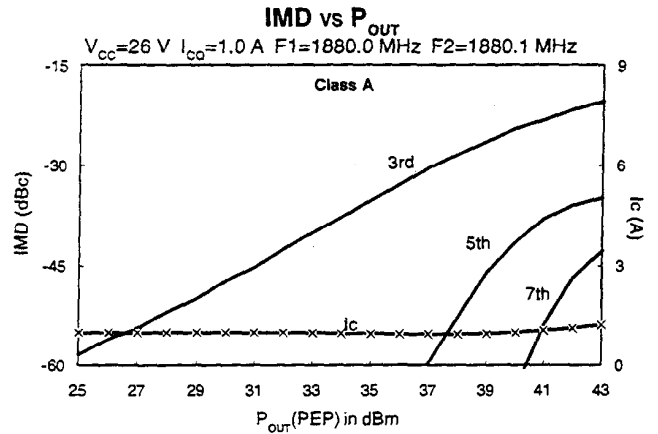
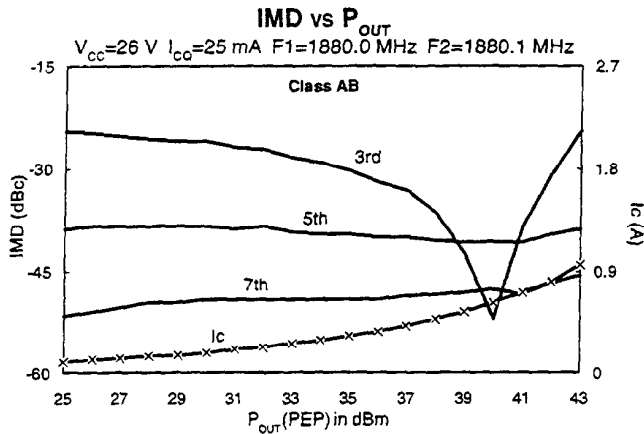
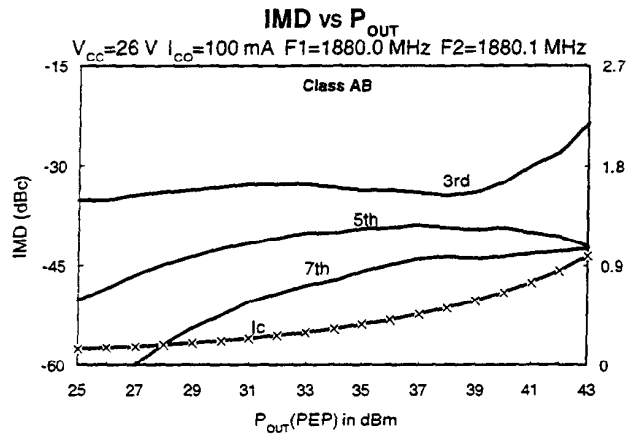
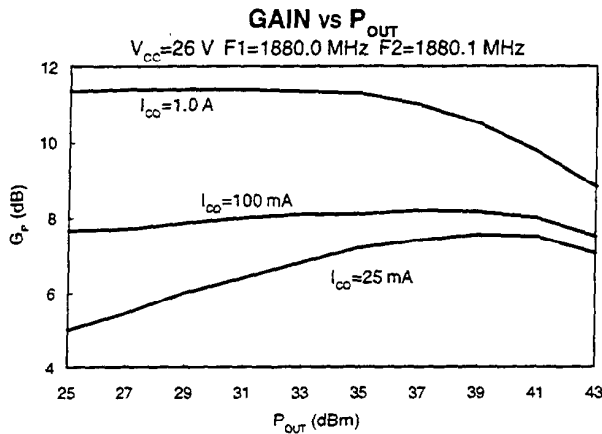
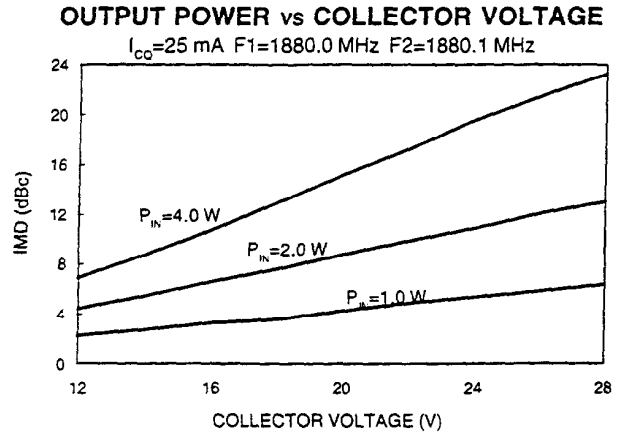
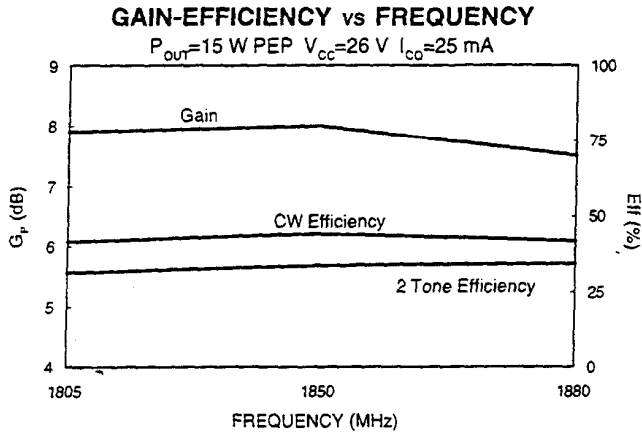

Specifications Subject to Change Without Notice.

M/A-COM, Inc.

North America: Tel. (800) 366-2266
 Fax (800) 618-8883

Asia/Pacific: Tel. +81 (03) 3226-1671
 Fax +81 (03) 3226-1451

Europe: Tel. +44 (1344) 869 595
 Fax +44 (1344) 300 020