

# **RTL8181 Wireless LAN Access Point/Gateway Controller**

## **DATA SHEET**

**ISSUE 4: June 10, 2003**

## Revision History

<b>Issue</b>	<b>Revision</b>	<b>Details of Change</b>	<b>Originator</b>	<b>Issue Date</b>
Issue 1	0.1	First Release	David Hsu	11/29/2002
Issue 2	0.2	<ol style="list-style-type: none"><li>1. Add a section about system configuration.</li><li>2. Add some descriptions about register usages.</li></ol>	David Hsu	12/9/2002
Issue 3	0.3	<ol style="list-style-type: none"><li>1. Add Pin number</li><li>2. Add System config register</li></ol>	Victor Hsu	03/03/2003
Issue 4	1.0	<ol style="list-style-type: none"><li>1. Add a memory map.</li><li>2. Modify some register definitions and function descriptions.</li><li>3. Add package information.</li><li>4. Remove 32 bits flash interface support</li><li>5. Add pin definitions for Maxim RF interface</li></ol>	Victor/David	2003/06/10

---

## Table of Contents

<b>1. OVERVIEW.....</b>	<b>4</b>
<b>2. PIN DESCRIPTION .....</b>	<b>5</b>
<b>3. ADDRESS MAPPING .....</b>	<b>12</b>
<b>4. REGISTER MAPPING.....</b>	<b>13</b>
<b>5. SYSTEM CONFIGURATION.....</b>	<b>16</b>
<b>6. INTERRUPT CONTROLLER .....</b>	<b>17</b>
<b>7. MEMORY CONTROLLER.....</b>	<b>18</b>
<b>8. ETHERNET CONTROLLER.....</b>	<b>21</b>
<b>9. UART CONTROLLER.....</b>	<b>30</b>
<b>10. TIMER &amp; WATCHDOG .....</b>	<b>33</b>
<b>11. GPIO CONTROL.....</b>	<b>35</b>
<b>12. 802.11B WLAN CONTROLLER.....</b>	<b>37</b>
<b>13. PACKAGE INFORMATION .....</b>	<b>48</b>

# 1. Overview

RTL8181 is a highly integrated SoC, embedded with a high-performance 32-bit RISC microcontroller, Ethernet and WLAN controller. It is a cost-effective and high-performance solution for the system of wireless LAN Access Point, wireless SOHO router, wireless Internet gateway, etc.

### System block diagram:

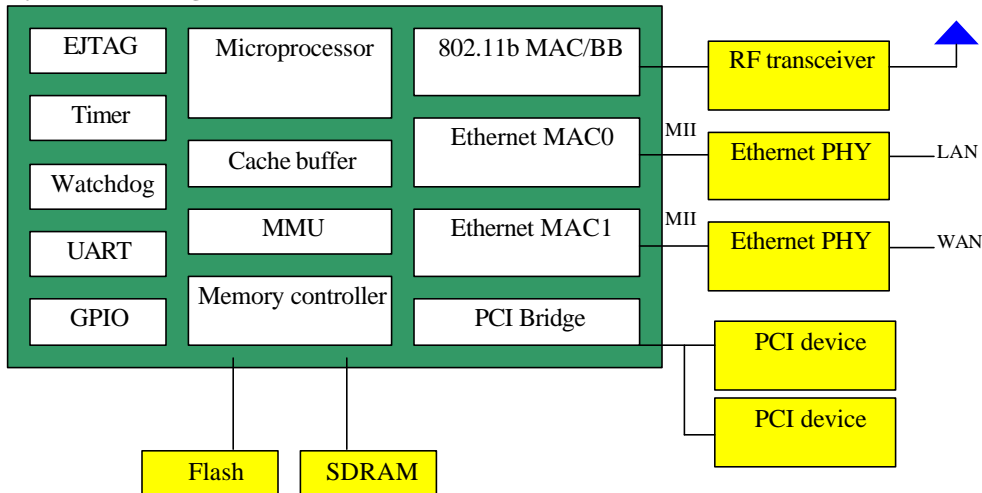

The embedded processor of RTL8181 is Lexra LX5280 32bit RISC CPU, with 8K separate instruction and data caches. A protection unit (MMU) allows the memory be segmented and protected, and this unit is required in the modern operation system (e.g., Linux).

The processor pipeline is a dual-issues and 6 stage architecture. The dual-issue CPU fetches two instructions per cycle, and which could allow two instructions are executed concurrently in two pipes via some instructions. Thus, its performance will achieve up to 30% improvement over uni-scalar architecture.

Besides, it includes two fast Ethernet MACs, one could be used for LAN interface and the other one could connect to WAN port. An IEEE 802.11b WLAN MAC+Baseband processor is embedded as well. By this build-in wireless controller, it could save a lot of costs and space comparing with the system designed with an external 802.11b adapter

The RTL8181 also integrates with memory controller, which allows customers use external SDRAM and Flash memory in glueless.

A PCI interface is supported as well, which enables customers to plug in a PCI device seamlessly. For example, an IEEE 802.11a device could be connected through this PCI interface to provide the WLAN dual mode service.

## Features

### Core Processor

- ✍ LX5280 32-bit RISC architecture.
- ✍ Superscalar architecture, containing 2 execution pipelines with better performance
- ✍ Embedded with 8K I-Cache, 8K D-Cache and 4K D-RAM.
- ✍ MMU supported
- ✍ Up to 200MHZ operating frequency

### WLAN Controller

- ✍ Integrated IEEE 802.11b complied MAC and DSSS Baseband processor
- ✍ Support Tx data rate in 11M, 5.5M, 2M and 1M
- ✍ Support long and short preamble
- ✍ Support antenna diversity and AGC.
- ✍ Embedded with encryption/decryption engine for 64 bits and 128 bits WEP

[www.DataSheet4U.com](http://www.DataSheet4U.com)

### Fast Ethernet Controller

- ✍ Fully compliant with IEEE 802.3/802.3u
- ✍ Support MII interface with full and half duplex capability
- ✍ Support descriptor-based buffer management with scatter-gather capability
- ✍ Support IP, TCP and UDP checksum offload
- ✍ Support IEEE 802.1Q VLAN tagging and 802.1P priority queue.
- ✍ Support full duplex flow control (IEEE 802.3X)

### UART

- ✍ 16550 compatible
- ✍ 16 bytes FIFO size
- ✍ Auto CTS/RTS flow control

### Memory Controller

- ✍ Support external 16/32-bit SDRAM with 2 banks access, up to 32M bytes
- ✍ Support external 16-bit Flash memory, up to 16M bytes

### PCI Bridge

- ✍ Support two external PCI devices, complied with PCI 2.2
- ✍ Support PCI master/slave mode
- ✍ 3.3 and 5V I/O tolerance

### GPIO

- ✍ 16 programmable I/O ports and more 16 port when memory interface is 16 bit mode.
- ✍ Individually configurable to input, output and edge transition

### Watchdog/Timer/Counter

- ✍ A hardware watchdog timer, used to reset processor when system hangs up
- ✍ 4 sets of general timers/counters

### EJTAG

- ✍ Standard P1149.1 JTAG interface for testing and debugging

## 2. Pin Description

Symbol	Typ e	Pin No(208)	Pin No(292)	Description
<b>Memory Interface</b>				
MD[31-0]	I/O	198,197,195, 194,193,19 2,191,190,1 88,187,185, 184,182,181 ,180,179,17 7,176,174,1 73,171,170, 169,168,166 ,165,163,16 2,161,160,1 59,158	P1,P2,N3,N 2,N1,M3,M 2,M1,L2,L3, L1,K2,K3,K 1,J2,J1,H2, H1,G2,F1,G 3,F2,E1,F3, E2,D1,D2,E 3,A1,B1,B2, C3	Data for SDRAM, Flash
MA[21-0]/ DQM[3-0]	O	115,116,118 ,119,121,12 2,124,125,1 27,128,130, 131,133,134 ,135,136,13	B14,A15,D1 4,C14,A14, C13,B13,C1 2,A12,C11, B11,C10,A1 1,B10,A10,	Address for SDRAM, Flash MA[15-18] mapping to DQM[3-0] for SDRAM

[www.DataSheet4U.com](http://www.DataSheet4U.com)

		8,139,141,142,144	C9,A9,B9,A7,C7,B7,A6	
M_CLK	O	152	A5	SDRAM clock
MCS0B	O	150	C5	Bank 0 chip select FLASH chip select
MCS1B	O	149	B5,	Bank 1 chip select FLASH chip select
RASB/OE B	O	157	D4	Raw address strobe for SDRAM; Output enable for Flash
CASB	O	156	A2	Column address strobe
MWENB	O	154	B4	Write enable for SDRAM and Flash
MCKE	O	153	A4	SDRAM Clock enable
MCS2B	O	147	D5	Bank 0 chip select for SDRAM
MCS3B	O	146	B6	Bank 1 chip select for SDRAM
<b>UART Interface</b>				
URTSB	O	16	Y8	UART Request to send
UCTSB	I	14	W7	UART Clear to send.
USIN	I	15	Y7	UART data receive serial input
USOUT	O	17	V8	UART data transmit serial output
<b>Power &amp; GND</b>				
PP[11-1]	P	208,178,164,151,137,123,83,58,52,30,4	K4,G4,F4,E4,D13,D12,D11,B18,B17,A19,A18,K17,P4,P17,R17,U7,U8,U14,U15	I/O power 3.3V (Digital),
GP[11-1]	P	204,189,167,155,140,126,80,63,42,20,1	K12,K11,K10,K9,K8,J12,J11,J10,J9,H11,H10,K13,L8,L9,L10,L11,L12,L13,M9,M10,M11,N10,N11	I/O 3.3V GND (Digital)
PD[7:5],PS[5:3]	P	183,175,132,196,148,74	N17,M4,L4,N4,U10,U11	Core logic power 1.8V (Digital)
GD[7-5],GS[5-3]	P	186,172,129,199,145,77	M8,J13,J8,R4,R3,J17	Core logic 1.8V Ground (Digital)
PA[6-1]	P	111,104,92,113,98,89	D16,D15,C15,C17,D20,G19	Wireless LAN power 3.3V(Analog)
GA[6-1],GA7	P	108,107,95,114,100,86,112	G17,F17,E17,C16,D19,G20,A20	Wireless LAN Ground (Analog), GA7 VSUB
PD[4-1]	P	120,72,48,28	J4,H4,D10,D9	Core logic 1.8V power(Digital)
GD[4-1]	P	117,69,45,25	H13,H12,H9,H8,M12,M13,N8,N9,N12,N13	Core logic LAN Ground(Digital)
PS[2:1]	P	36,7	D6,C6,U4,U5,U12,L17,M17	Core logic power 1.8V(Digital)
GS[2:1]	P	39,10	D8,D7,T4,U6,U13	Core logic 1.8V GND
<b>WLAN Traffic LED Control</b>				
WLTXXRX LED0B	O	65	T19	WLAN Tx/Rx traffic indicator or JTAG reset.

WLTXRX LED1B	O	64	T18	WLAN Tx/Rx traffic indicator or JTAG CLK
<b>RF Interface for Intersil</b>				
RIFSCK	O	66	R20	3-wire Bus Clock
RIFSD	O	67	P19	3-wire Bus Data
RFLE	O	68	P18	3-wire Bus Enable
IFLE/AGC SET	O	70	N18	IF_LE of the Intersil Chipset: PLL Synthesizer Serial Interface Latch Enable Control. CMOS output.
CALEN/AGCRESET	O	71	P20	CAL_EN of the Intersil Chipset: CMOS output for activation of DC offset adjust circuit. A rising edge activates the calibration cycle, which completes within a programmable time and holds the calibration while this pin is held high. In applications where the synthesizer is not used, this pin needs to be grounded.
LNA_HL	O	73	M19	Drive to the RF AGC Stage Attenuator: CMOS digital.
ANTSELP	O	75	M20	Antenna Select +: The antenna selects signal changes state as the receiver switches from antenna to antenna during the acquisition process in the antenna diversity mode. This is a complement for ANTSELN for differential drive of antenna switches.
ANTSELN	O	76	L18	Antenna Select -: The antenna selects signal changes state as the receiver switches from antenna to antenna during the acquisition process in the antenna diversity mode. This is a complement for ANTSELP for differential drive of antenna switches.
TRSWP	O	78	L19	Transmit/Receive Control
TRSWN	O	79	L20	
VCOPDN/PHITXI	O	81	K20	Output Pin as VCO VCC Power Enable/Disable.
PAPE	O	82	K19	Transmit PA Power Enable
PE1/PHITXQ	O	84	K18	The combination of PE1 and PE2 are as follows: 00: Power Down State, PLL Registers in Save Mode, Inactive PLL, Active Serial 11: Receive State, Active PLL 10: Transmit State, Active PLL 01: Inactive Transmit and Receive States, Active PLL, Active Serial Interface
PE2	O	85	J20	Output Pin as PE2: Refer to PE1 description.
RXIP	AI	110	B19	Receive (Rx) In-phase Differential Analog Data
RXIN	AI	109	B20	
RXQP	AI	106	C18,C19	Receive (Rx) Quadrature Differential Analog Data
RXQN	AI			
RSSI	AI	105	D17	Analog Input to the Receive Power A/D Converter for AGC Control
TXDET	AI	102	D18	Input to the Transmit Power A/D Converter for Transmit AGC Control
VREFI	AI	101	C20	Voltage Reference for ADC and DAC
TXIP	AO	97	E19,F18	Transmit (TX) In-phase Differential Analog Data
TXIN	AO	96		
TXQP	AO	94	E20,F20	Transmit (TX) Quadrature Differential Analog Data
TXQN	AO	93		
TXAGC	AO	91	F19	Analog Drive to the Transmit IF Power Control
RXAGC	AO	90	G18	Analog Drive to the Receive IF AGC Control
<b>RF Interface for RFMD</b>				
RIFSCK	O	66	R20	3-wire Bus Clock: The serial clock output, with resistive dividers on board to allow programming from +5V levels.
RIFSD	O	67	P19	3-wire Bus Data: Serial data output, with resistive dividers on board to allow programming from +5V levels.
RFLE	O	68	P18	3-wire Bus Enable: Enable serial port output, with resistive dividers on board to allow programming from +5V levels.
IFLE/AGC SET	X*	70	N18	Not used in the RFMD RF chipset.
CALEN/AGCRESET	X	71	P20	Not used in the RFMD RF chipset.
LNA_HL	O	73	M19	RF2494 Gain Select: Digital output.

ANTSELP	O	75	M20	Antenna Select +: The antenna selects signal changes state as the receiver switches from antenna to antenna during the acquisition process in the antenna diversity mode. This is a complement for ANTSEL- for differential drive of antenna switches.
ANTSELN	X	76	L18	Not used in the RFMD RF chipset.
TRSWP	X	78	L19	Not used in the RFMD RF chipset.
TRSWN	X	79	L20	Not used in the RFMD RF chipset.
VCOPDN/ PHITXI	O/I	81	K20	Output Pin as VCO VCC Power Enable/Disable.
PAPE	O	82	K19	Power Control Output for RF2189 PA: 0V to +3.3V.
PE1/PHIT XQ	O	84	K18	This pin is the shutdown control output on board regulator when the RF Module enters either power-saving or standby mode.
PE2	O	85	J20	Output pin as RF2948 RX EN/ TX EN, RF2494 OE and CE: Refer to the RF2948 and RF2494 datasheets.
RXIP	AI*	110	B19	Receive (Rx) In-phase Analog Data in Single Ended
RXIN	X	109	B20	Not used in RFMD RF chipset.
RXQP	AI	106	C18	Receive (Rx) Quadrature-phase Analog Data in Single Ended
RXQN	X	105	C19	Not used in RFMD RF chipset.
RSSI	X	103	D17	Not used in RFMD RF chipset.
TXDET	AI	102	D18	To internal ADC which detects transmit power.
VREFI	AI	101	C20	Reference voltage for ADC, DAC from VREF1 of RF2948B.
TXIP	AO	97	E19	Transmit (TX) In-phase Digital Data: Combining before connecting to TX_I of RF2948B.
TXIN	AO	96	F18	
TXQP	AO	94	E20	Transmit (TX) Quadrature Digital Data: Combining before connecting to TX_Q of RF2948B.
TXQN	AO	93	F20	
TXAGC	AO	91	F19	Transmit gain control output to RF2948.
RXAGC	AO	90	G18	RF2948 VGC receiver gain control analog output.
<b>RF Interface for Philip</b>				
RIFSCK	O	66	R20	3-wire Bus Clock: The pin RIFSCK is the “shift clock” output. If the 3-wire bus is enabled, address or data bits will be clocked out from the RIFSD pin with rising edges of RIFSCK.
RIFSD	O	67	P19	3-wire Bus Data: The pin RIFSD is the output “data” pin. The detail timing is on 11.3.3.
RFLE	O	68	P18	3-wire Bus Enable: The pin RFLE is an “enable” signal. It is level sensitive: If RFLE is of LOW value, the 3-wire bus interface on the SA2400 is enabled. This means that each rising edge on the RIFSCK pin will be taken as a shift cycle, and address/data bits are expected on RIFSD. If RFLE is HIGH, the 3-wire bus interface is disabled. No register settings will change regardless activity on RIFSCK and RIFSD.
IFLE/AGC SET	I	70	N18	AGCSET of the Philips Chipset: On the digital output pin AGCRESET, a 0 => 1 transition clears AGCSET of SA2400 to logic 0 and SA2400 starts the AGC cycle. At end of AGC cycle, the AGCSET of SA2400 is asserted to logic 1. Then, AGCRESET will return to logic low.
CALEN/ AGCRESE T	O	71	P20	AGCRESET of the Philips Chipset: Please refer to the AGCSET description and Philips SA2400 datasheet.
LNA_HL	X*	73	M19	Not used in Philips RF chipset.
ANTSELP	O	75	M20	Antenna Select +: The antenna selects signal changes state as the receiver switches from antenna to antenna during the acquisition process in the antenna diversity mode. This is a complement for ANTSEL- for differential drive of antenna switches.
ANTSELN	O	76	L18	Antenna Select -: The antenna selects signal changes state as the receiver switches from antenna to antenna during the acquisition process in the antenna diversity mode. This is a complement for ANTSEL+ for differential drive of antenna switches.
TRSWP	O	78	L19	Transmit and Receive Switch Control: This is a complement for TRSW-. 1:TX 0:RX



TRSWN	O	J.079	L20	Transmit and Receive Switch Control: This is a complement for TRSW+. 1:RX 0:TX
VCOPDN/ PHITXI/	O/I	81	K20	Output Pin as Transmit (TX) In-phase Digital Data of the Philips Chipset. This function is valid on Tx digital mode (AnalogPhy = Digital on EEPROM writer program).
PAPE	O	82	K19	Transmit PA Power Enable: Assert high when starting transmission.
PE1/PHIT XQ	O	84	K18	Transmit (TX) Quadrature Digital Data of Philips Chipset. This function is valid on Tx digital mode (AnalogPhy = Digital on EEPROM writer program).
PE2	O	85	J20	Output Pin as TX/RX Control: 1:RX 0:TX
RXIP	AI*	110	B19	Receive (Rx) In-phase Analog Data: Positive path of differential pair.
RXIN	AI	109	B20	Receive (Rx) In-phase Analog Data: Negative path of differential pair.
RXQP	AI	106	C18	Receive (Rx) Quadrature-phase Analog Data: Positive path of the differential pair.
RXQN	AI	105	C19	Receive (Rx) Quadrature-phase Analog Data: Negative path of the differential pair.
RSSI	AI	103	D17	Received Signal Strength Indication: To internal ADC.
TXDET	AI	102	D18	Transmit Power Detect: To internal ADC which detects transmit power.
VREFI	AI	101	C20	Reference Voltage for ADC & DAC
TXIP	AO	97	E19	Transmit (Tx) In-phase Analog Data: Positive path of differential pair. This function is valid on Tx digital mode (AnalogPhy = Digital on EEPROM writer program).
TXIN	AO	96	F18	Transmit (Tx) In-phase Analog Data: Negative path of differential pair. This function is valid on Tx digital mode (AnalogPhy = Digital on EEPROM writer program).
TXQP	AO	94	E20	Transmit (Tx) Quadrature-phase Analog Data: Positive path of the differential pair. This function is valid on Tx digital mode (AnalogPhy = Digital on EEPROM writer program).
TXQN	AO	93	F20	Transmit (Tx) Quadrature-phase Analog Data: Negative path of the differential pair. This function is valid on Tx digital mode (AnalogPhy = Digital on EEPROM writer program).
TXAGC	X	91	F19	Not used in Philips RF chipset
RXAGC	X	90	G18	Not used in Philips RF chipset
<b>RF Interface for Maxim</b>				
RIFSCK	O	66	R20	3-wire Bus Clock: The serial clock output
RIFS D	O	67	P19	3-wire Bus Data: Serial data output
RFLE	O	68	P18	3-wire Bus Enable: Enable serial port output
IFLE/AGC SET	X*	70	N18	Not used in the Maxim RF chipset.
CALEN/ AGCRESE T	X	71	P20	Not used in the Maxim RF chipset.
LNA_HL	O	73	M19	LNA Gain Select Logic Output: Logic high for LNA high-gain mode, logic low for LNA low-gain mode.
ANTSELP	O	75	M20	Antenna Select +: The antenna selects signal changes state as the receiver switches from antenna to antenna during the acquisition process in the antenna diversity mode. This is a complement for ANTSEL- for differential drive of antenna switches.
ANTSELN	X	76	L18	Antenna Select -: The antenna selects signal changes state as the receiver switches from antenna to antenna during the acquisition process in the antenna diversity mode. This is a complement for ANTSEL+ for differential drive of antenna switches.
TRSWP	X	78	L19	Not used in the Maxim RF chipset.
TRSWN	X	79	L20	Not used in the Maxim RF chipset.
VCOPDN/ PHITXI	O/I	81	K20	Output Pin as VCO VCC Power Enable/Disable.

PAPE	O	82	K19	Transmit PA Power Enable: Assert high when starting transmission.
PE1/PHIT XQ	O	84	K18	Not used in the Maxim RF chipset.
PE2	O	85	J20	Not used in the Maxim RF chipset now.
RXIP	AI*	110	B19	Receive (Rx) In-phase Analog Data: Positive path of differential pair.
RXIN	X	109	B20	Receive (Rx) In-phase Analog Data: Negative path of differential pair.
RXQP	AI	106	C18	Receive (Rx) Quadrature-phase Analog Data: Positive path of differential pair.
RXQN	X	105	C19	Receive (Rx) Quadrature-phase Analog Data: negative path of differential pair.
RSSI	X	103	D17	Not used in Maxim RF chipset.
TXDET	AI	102	D18	To internal ADC which detects transmit power.
VREFI	AI	101	C20	Not used in Maxim RF chipset.
TXIP	AO	97	E19	Transmit (TX) In-phase Digital Data: Combining before connecting to TX_I of RF2948B.
TXIN	AO	96	F18	
TXQP	AO	94	E20	Transmit (TX) Quadrature Digital Data: Combining before connecting to TX_Q of RF2948B.
TXQN	AO	93	F20	
TXAGC	AO	91	F19	Transmit gain control output to RF2948.
RXAGC	AO	90	G18	Analog Drive to the Receiver AGC Control.
<b>Miscellaneous</b>				
R10K	I/O	99	E18	This pin must be pulled low by a 10K Ω resistor.
XO	O	87	H18	Crystal Feedback Output: This output is reserved for crystal connection. It should be left open when XI is driven with an external 44 MHz oscillator.
XI	I	88	H19	44 MHz OSC Input
<b>PCI Interface</b>				
AD31-0	T/S	*X	A13,B12,A8,C8,B8,C4,B3,A3,C2,D3,C1,G1,H3,J3,V2,V1,V3,W2,V4,w3,Y3,W6,Y6,V7,Y14,W14,Y15,Y19,U16,R18,T20,R19	PCI address and data multiplexed pins. The address phase is the first clock cycle in which FRAMEB is asserted. During the address phase, AD31-0 contains a physical address (32 bits). For I/O, this is a byte address, and for configuration and memory, it is a double-word address. Write data is stable and valid when IRDYB is asserted. Read data is stable and valid when TRDYB is asserted. Data I is transferred during those clocks where both IRDYB and TRDYB are asserted.
C/BE3-0	T/S	*X	W20,V19,U17,V20	PCI bus command and byte enables multiplexed pins. During the address phase of a transaction, C/BE3-0 define the bus command. During the data phase, C/BE3-0 are used as Byte Enables. The Byte Enables are valid for the entire data phase and determine which byte lanes carry meaningful data. C/BE0 applies to byte 0, and C/BE3 applies to byte 3.
CLK	O	*X	N19	PCI clock: This clock input provides timing for all PCI transactions and is input to the PCI device.
DEVSELB	S/T/S	*X	P3	Device Select: As a bus master, the RTL8181 samples this signal to insure that a PCI target recognizes the destination address for the data transfer.
FRAMEB	S/T/S	*X	N20	Cycle Frame: As a bus master, this pin indicates the beginning and duration of an access. FRAMEB is asserted low to indicate the start of a bus transaction. While FRAMEB is asserted, data transfer continues. When FRAMEB is deasserted, the transaction is in the final data phase. As a target, the device monitors this signal before decoding the address to check if the current transaction is addressed to it.
GNTB	T/S	*X	H20	Grant:Grant indicate to the agent that access to the bus has been granted.
REQB	T/S	*X	J18	Request: Request indicates to the arbiter that this agent desires use of the bus.
IDSEL	O	*X	A16	Initialization Device Select: This pin is used as a chip select during configuration read and write transactions..
INTAB	O/D	*X	A17	Interrupt A: Used to request an interrupt. It is asserted low when an interrupt condition occurs, as defined by the Interrupt Status, Interrupt Mask.
IRDYB	S/T/S	*X	M18	Initiator Ready: This indicates the initiating agent's ability to complete the current data phase of the transaction. As a bus master, this signal will be asserted low when the RTL8181 is ready to

[www.DataSheet4U.com](http://www.DataSheet4U.com)

				complete the current data phase transaction. This signal is used in conjunction with the TRDYB signal. Data transaction takes place at the rising edge of CLK when both IRDYB and TRDYB are asserted low. As a target, this signal indicates that the master has put data on the bus.
TRDYB	S/T/ S	*X	J19	Target Ready: This indicates the target agent's ability to complete the current phase of the transaction. As a bus master, this signal indicates that the target is ready for the data during write operations and with the data during read operations. As a target, this signal will be asserted low when the (slave) device is ready to complete the current data phase transaction. This signal is used in conjunction with the IRDYB signal. Data transaction takes place at the rising edge of CLK when both IRDYB and TRDYB are asserted low.
PAR	T/S	*X	R2	Parity: This signal indicates even parity across AD31-0 and C/BE3-0 including the PAR pin. PAR is stable and valid one clock after each address phase. For data phase, PAR is stable and valid one clock after either IRDYB is asserted on a write transaction or TRDYB is asserted on a read transaction. Once PAR is valid, it remains valid until one clock after the completion of the current data phase. As a bus master, PAR is asserted during address and write data phases. As a target, PAR is asserted during read data phases.
STOPB	S/T/ S	*X	B16	Stop: Indicates that the current target is requesting the master to stop the current transaction.
RSTB	O	*X	B15	Reset: Active low signal to reset the PCI device.
<b>MII Interface</b>				
LTXC, WTXC	I	53,31	Y20 W11	TXC is a continuous clock that provides a timing reference for the transfer of TXD[3:0], TXE. In MII mode, it uses the 25 MHz or 2.5 MHz supplied by the external PMD device.
LTXEN, WTXEN	O	59,37	T17	Indicates the presence of valid nibble data on TXD[3:0].
LTXD[3-0], WTXD [3-0]	O	57,56,55,54 35,34,33,32	V18,V17,W 19,W18 V12,Y13,W 12,Y12	Four parallel transmit data lines which are driven synchronous to the TXC for transmission by the external physical layer chip.
LRXC, WRXC	I	51,29	W17,V11	This is a continuous clock that is recovered from the incoming data. MRXC is 25MHz in 100Mbps and 2.5Mhz in 10Mbps.
LCOL, WCOL	I	60,38	U18,V13	This signal is asserted high synchronously by the external physical unit upon detection of a collision on the medium. It will remain asserted as long as the collision condition persists.
LRXDV, WRXDV	I	43,44	W16,W9	Data valid is asserted by an external PHY when receive data is present on the RXD[3:0] lines, and it is deasserted at the end of the packet. This signal is valid on the rising of the RXC.
LRXD[3-0], WRXD[3-0]	I	50,49,47,46 27,26,24,23	V15,V16,Y 18,Y17,Y11 ,W10,V10, Y10	This is a group of 4 data signals aligned on nibble boundaries which are driven synchronous to the RXC by the external physical unit
LRXER, WRXER	I	44,22	V14,V9	This pin is asserted to indicate that invalid symbol has been detected in 100Mbps MII mode. This signal is synchronized to RXC and can be asserted for a minimum of one receive clock.
LMDC, WMDC	O	40,18	W15,W8	Management Data Clock: This pin provides a clock synchronous to MDIO, which may be asynchronous to the transmit TXC and receive RXC clocks.
LMDIO, WMDIO	I/O	41,19	Y16,Y9	Management Data Input/Output: This pin provides the bi-directional signal used to transfer management information.
<b>GPIO</b>				
GPIOB[11-0]	I/O	205,206,207, 2,3,5,6,8,9,1 1,12,13	U1,U2,U3, W1,Y1,Y2, W4,V5,Y4, W5,V6,Y5	General purpose I/O pins group B pins 11 to 0. If ICFG[5-4] power on latch =[1-0]. GPIO[5-2] mapping to JTAG_TDO(JTAG test data output),JTAG_TRSTN(JTAG reset),JTAG_TMS(JTAG test mode select),JTAG_TDI(JTAG test data input).
GPIOB[15-12]	I/O	200,201,202, 203	R1,T1,T2,T 3	General purpose I/O pins group B pin 15 to 12.

www.\*A=Analog signal  
 \*X=Not used .

### 3. Address Mapping

The RTL8181 supports up to 4 gigabytes of address space. The memory map of RTL8181 is managed by MMU, which will translate the virtual address to physical address. The memory is segmented into four regions by its access mode and caching capability as shown in following table.

Segment	Size	Caching	Virtual address range	Physical address range	Mode
KUSEG	2048M	cacheable	0x0000_0000-0x7fff_ffff	set in TLB	user/kernel
KSEG0	512M	cacheable	0x8000_0000-0x9fff_ffff	0x0000_0000-0x1fff_ffff	kernel
KSEG1	512M	uncachable	0xa000_0000-0xbfff_ffff	0x0000_0000-0x1fff_ffff	kernel
KSEG2	512M	cacheable	0xc000_0000-0xfeff_ffff	set in TLB	kernel
KSEG2	512M	cacheable	0xff00_0000-0xffff_ffff	0xff00_0000-0xffff_ffff	kernel

The RTL8181 has two memory mapping modes: direct memory mapping and TLB (Translation Look-aside Buffer) address mapping. When virtual address is located in the regions KSEG0, KSEG1 or higher half of KSEG2 segments, its physical address will be mapped directly from virtual address with an offset. If virtual address used is in the regions of KUSEG or lower half of KSEG2 segment, its physical address will be referred from TLB entry. RTL8181 contains 16 TLB entries, each of which maps to a page, with read/write access, cache-ability and process id.

In RTL8181, SDRAM is mapped from physical address 0x0000\_0000 to maximum 0x01ff\_ffff (32M bytes). After reset, RTL8181 will start to fetch instructions from physical address 0x1fc0\_0000, the starting address of flash memory. The flash memory is mapped from physical address 0x1fc0\_0000 to maximum 0x1fff\_ffff (4M bytes).

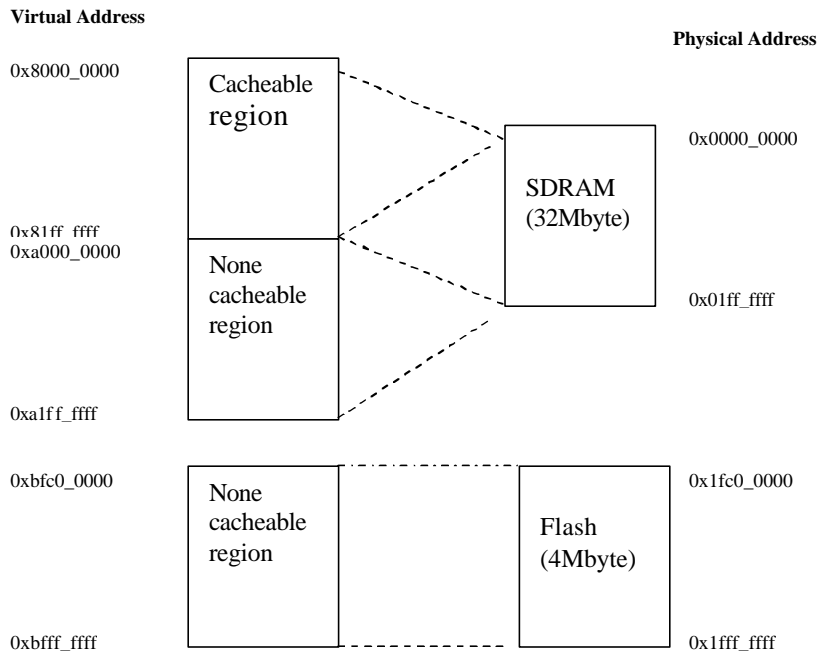
[www.DataSheet4U.com](http://www.DataSheet4U.com)
**Memory map (without TLB):**

The memory map of RTL8181 I/O devices and registers are located in KSEG1 segment (uncacheable region). The following table illustrates the address map:

Virtual address range	Size (bytes)	Mapped device
0xBD01_0000 – 0xBD01_0FFF	4K	Special function registers (note)
0xBD01_1000 – 0xBD01_1FFF	4K	Memory controller registers
0xBD20_0000 – 0xBD2F_FFFF	1M	Ethernet0
0xBD30_0000 – 0xBD3F_FFFF	1M	Ethernet1
0xBD40_0000 – 0xBD4F_FFFF	1M	WLAN controller
0xBD50_0000 – 0xBD5F_FFFF	1M	IO map address of PCI device
0xBD60_0000 – 0xBD6F_FFFF	1M	Memory map address of PCI device
0xBD70_0000 – 0xBD77_FFFF	512K	Configuration space of PCI device0
0xBD78_0000 – 0xBD7F_FFFF	512K	Configuration space of PCI device1

NOTE: The special function includes interrupt control, timer, watchdog, UART, and GPIO.

## 4. Register Mapping

The following table displays the address mapping of the all registers:

Virtual Address	Register Symbol	Register Name
<b>Interrupt Controller</b>		
0xBD01_0000	GIMR	Global mask register
0xBD01_0004	GISR	Global interrupt status register
<b>GPIO</b>		
0xBD01_0040	PABDIR	Port A/B direction register
0xBD01_0044	PABDATA	Port A/B data register
0xBD01_0048	PBIMR	Port B interrupt mask register
0xBD01_004C	PBISR	Port B interrupt register
<b>Timer</b>		
0xBD01_0050	TCCNT	Timer/Counter control register

0xBD01_0054	TCIR	Timer/Counter interrupt register
0xBD01_0058	CDDR	Clock division base register
0xBD01_005C	WDTCNR	Watchdog timer control register
0xBD01_0060	TC0DATA	Timer/Counter 0 data register
0xBD01_0064	TC1DATA	Timer/Counter 1 data register
0xBD01_0068	TC2DATA	Timer/Counter 2 data register
0xBD01_006C	TC3DATA	Timer/Counter 3 data register
0xBD01_0070	TC0CNT	Timer/Counter 0 count register
0xBD01_0074	TC1CNT	Timer/Counter 1 count register
0xBD01_0078	TC2CNT	Timer/Counter 2 count register
0xBD01_007C	TC3CNT	Timer/Counter 3 count register
<b>UART</b>		
0xBD01_00C3	UART_RBR	UART receiver buffer register
0xBD01_00C3	UART_THR	UART transmitter holding register
0xBD01_00C3	UART_DLL	UART divisor latch LSB
0xBD01_00C7	UART_DLM	UART divisor latch MSB
0xBD01_00C7	UART_IER	UART interrupt enable register
0xBD01_00CB	UART_IIR	UART interrupt identification register
0xBD01_00CB	UART_FCR	UART FIFO control register
0xBD01_00CF	UART_LCR	UART line control register
0xBD01_00D3	UART_MCR	UART modem control register
0xBD01_00D7	UART_LSR	UART line status register
0xBD01_00DB	UART_MSR	UART modem status register
0xBD01_00DF	UART_SCR	UART scratch register
<b>System Config register</b>		
0xBD01_0100	BRIDGE_REG	WLAN, Eherernet0, Ethernet1 and PCI bridge configuration register
0xBD01_0104	PLLMN_REG	DLL M,N parameter
0xBD01_0108	MEM_REG	Memory clock setting
0xBD01_0109	CPU_REG	CPU clock setting
<b>Memory controller</b>		
0xBD01_1000	MCR	Memory configuration register
0xBD01_1004	MTCR0	Memory timing configuration register 0
0xBD01_1008	MTCR1	Memory timing configuration register 1
<b>Ethernet0</b>		
0xBD20_0000	ETH0_CNR1	Ethernet0 control register 0
0xBD20_0004	ETH0_ID	Ethernet0 ID
0xBD20_000C	ETH0_MAR	Ethernet0 multicast register
0xBD20_0014	ETH0_TSAD	Ethernet0 transmit starting address descriptor
0xBD20_0018	ETH0_RSAD	Ethernet0 receive starting address descriptor
0xBD20_0020	ETH0_IMR	Ethernet0 interrupt mask register
0xBD20_0024	ETH0_ISR	Ethernet0 interrupt status register
0xBD20_0028	ETH0_TMF0	Ethernet 0 Type filter0 register
0xBD20_002C	ETH0_TMF1	Ethernet 0 Type filter1 register
0xBD20_0030	ETH0_TMF2	Ethernet 0 Type filter2 register
0xBD20_0034	ETH0_TMF3	Ethernet 0 Type filter3 register
0xBD20_0038	ETH0_MII	Ethernet0 MII access register
0xBD20_003C	ETH0_CNR2	Ethernet0 control register 2
0xBD20_0040	ETH0_UAR	Ethernet0 unicast address register
0xBD20_0080	ETH0_MPC	Ethernet0 mismatch packet counter
0xBD20_0083	ETH0_TXCOL	Ethernet0 transmit collision counter
0xBD20_0085	ETH0_RXER	Ethernet0 receive error count
<b>Ethernet1</b>		
0xBD30_0000	ETH1_CNR1	Ethernet1 control register 0
0xBD30_0004	ETH1_ID	Ethernet1 ID
0xBD30_000C	ETH1_MAR	Ethernet1 multicast register



0xBD30_0014	ETH1_TSAD	Ethernet1 transmit starting address descriptor
0xBD30_0018	ETH1_RSAD	Ethernet1 receive starting address descriptor
0xBD30_0020	ETH1_IMR	Ethernet1 interrupt mask register
0xBD30_0024	ETH1_ISR	Ethernet1 interrupt status register
0xBD30_0028	ETH1_TMF0	Ethernet1 type match filter 0
0xBD30_002C	ETH1_TMF1	Ethernet1 type match filter 1
0xBD30_0030	ETH1_TMF2	Ethernet1 type match filter 2
0xBD30_0034	ETH1_TMF3	Ethernet1 type match filter 3
0xBD30_0038	ETH1_MII	Ethernet1 MII access register
0xBD30_003C	ETH1_CNR2	Ethernet1 control register 2
0xBD30_0080	ETH1_MPC	Ethernet1 mismatch packet counter
0xBD30_0083	ETH1_TXCOL	Ethernet1 transmit collision counter
0xBD30_0085	ETH1_RXER	Ethernet1 receive error count
<b>WLAN controller</b>		
0xBD40_0000	WLAN_ID	WLAN ID
0xBD40_0008	WLAN_MAR	WLAN multicast register
0xBD40_0018	WLAN_TSFTTR	WLAN timing synchronization function timer register
0xBD40_0020	WLAN_TLPDA	WLAN transmit low priority descriptors start address
0xBD40_0024	WLAN_TNPDA	WLAN transmit normal priority descriptors start address
0xBD40_0028	WLAN_THPDA	WLAN transmit high priority descriptors start address
0xBD40_002C	WLAN_BRSR	WLAN basic rate set register
0xBD40_002E	WLAN_BSSID	WLAN basic service Set ID
0xBD40_0037	WLAN_CR	WLAN command register
0xBD40_003C	WLAN_IMR	WLAN interrupt mask register
0xBD40_003E	WLAN_ISR	WLAN interrupt status register
0xBD40_0040	WLAN_TCR	WLAN transmit configuration register
0xBD40_0044	WLAN_RCR	WLAN receive configuration register
0xBD40_0048	WLAN_TINT	WLAN timer interrupt register
0xBD40_004C	WLAN_TBDA	WLAN transmit beacon descriptor start address
0xBD40_0050	WLAN_CR	WLAN command register
0xBD40_0051	WLAN_CONFIG0	WLAN configuration register 0
0xBD40_0053	WLAN_CONFIG2	WLAN configuration register 2
0xBD40_0054	WLAN_ANAPARM	WLAN analog parameter
0xBD40_0058	WLAN_MSR	WLAN media status register
0xBD40_0059	WLAN_CONFIG3	WLAN configuration register 3
0xBD40_005A	WLAN_CONFIG4	WLAN configuration register 4
0xBD40_005B	WLAN_TESTR	WLAN test mode register
0xBD40_005F	WLAN_SCR	WLAN security configuration register
0xBD40_0070	WLAN_BCNTIV	WLAN beacon interval register
0xBD40_0072	WLAN_ATIMWND	WLAN ATIM window register
0xBD40_0074	WLAN_BINTRITV	WLAN beacon interrupt interval register
0xBD40_0076	WLAN_ATIMTRITV	WLAN ATIM interrupt interval register
0xBD40_0078	WLAN_PHYDELAY	WLAN PHY delay register
0xBD40_007A	WLAN_CRC16ERR	WLAN CRC16 error count
0xBD40_007C	WLAN_PHYADDR	WLAN PHY address register
0xBD40_007D	WLAN_PHYDATAW	WLAN write data to PHY
0xBD40_007E	WLAN_PHYDATAR	WLAN read data from PHY
0xBD40_0080	WLAN_PHYCFG	WLAN PHY configuration register
0xBD40_0090	WLAN_DK0	WLAN default key 0 register
0xBD40_00A0	WLAN_DK1	WLAN default key 1 register
0xBD40_00B0	WLAN_DK2	WLAN default key 2 register
0xBD40_00C0	WLAN_DK3	WLAN default key 3 register
0xBD40_00D8	WLAN_CONFIG5	WLAN configuration register 5
0xBD40_00D9	WLAN_TPPOLL	WLAN transmit priority polling register
0xBD40_00DC	WLAN_CWR	WLAN contention window register
0xBD40_00DE	WLAN_RETRYCTR	WLAN retry count register
0xBD40_00E4	WLAN_RDSAR	WLAN receive descriptor start address register

0xBD40_0100	WLAN_KMAR	WLAN key map address register
0xBD40_0106	WLAN_KMKEY	WLAN key map key value
0xBD40_0116	WLAN_KMC	WLAN key map configuration

## 5. System Configuration

### GPIO pin for system configuration

GPIOB pin	Power on Latch Value	Operating setting	Power on default
9-6	1111 other values are reserved	CPU=200, MEM=100 if Memory use asynchronous mode	1,1,1,1
11,10	01 11 other values are reserved	JTAG mode Normal mode (wlan LED)	1,1
13	1 0	Memory clock use asynchronous mode. Synchronous mode, the MEM clock same as CPU clock	1
15-14	Reserved	Reserved	
1,0	Reserved	Reserved	1,1

### System Control Register Set

Virtual address	Size (byte)	Name	Description
0xBD01_0100	4	BRIDGE_REG	WLAN, Ethernet0, Ethernet1 and PCI bridge configuration register
0xBD01_0104	4	PLLMN_REG	RTL8181 DPLL parameter
0xBD01_0108	1	MEM_REG	RTL8181 Memory clock rate
0xBD01_0109	1	CPU_REG	RTL8181 CPU clock rate

### Bridge Control Register (BRIDGE\_REG)

Since the Lexra bus clock rate is fast than the network device, it needs a bus bridge between the CPU and device (i.e., Ethernet and Wireless LAN controller). Also, this bridge is existed between CPU and PCIbridge.

Bit	Bit Name	Description	R/W	InitVal
2-0	NIC0CKR	Bus clock to NIC0 clock ratio. 001= 1:2, 011=1:4,101=1:6,111=1:8 ,other value reserved. The NIC0 and NIC1 maximum clock is 50MHz.	R/W	011
3	NIC0CKREN	NIC0CKR write enable	R/W	0
6-4	-	Reserved	-	-
7	DISNIC0B	Disable NIC0,0 enable NIC0, 1 disable NIC0	R/W	0
10-8	NIC1CKR	Bus clock to NIC1 clock ratio. 001= 1:2, 011=1:4,101=1:6,111=1:8 ,other value reserved	R/W	011
11	NIC1CKREN	NIC0CKR write enable	R/W	0
14-12	-	Reserved	R/W	0
15	DISNIC1B	Disable NIC1,0 enable NIC1, 1 disable NIC1	R/W	0
18-16	PCICLKR	Bus clock to PCI clock ratio. 000=1:1,001= 1:2,010=1:3,011=1:4,100=1:5,101=1:6,110=1: 7,111=1:8. The PCI maximum clock is 50MHz.	R/W	101
19	PCICKREN	PCICLKR write enable	R/W	0
20	LXPCI	The external Bus is PCI or Lexra(debug mode).0 Lexra, 1 PCI.	R/W	1
21	PCI2ENB	The second PCI bus enable. 0 enable second PCI device,1 disable second PCI device	R/W	1
22	Reserved			



23	DISPCIB <sub>n</sub>	Disable PCI bridge,0 enable PCI bridge,1 disable PCI bridge	R/W	0
26-24	WLANCKR	Bus clock to WLAN clock ratio. 000=1:1,001=1:2,010=1:3,011=1:4,100=1:5,101=1:6,110=1:7,111=1:8. The WLAN maximum clock is 40MHz.	R/W	101
27	WLANCKREN	WLANCKR write enable	R/W	0
30-28	Reserved	-	-	-
31	DISWLANB	Disable WLAN, 0 enable WLAN,1 disable WLAN	R/W	0

**DPLL M,N parameter Register (PLLMN\_REG)**

The DPLL clock rate is setting by this equation:  
 $44\text{MHz} * (M+1) / (N+1)$

Bit	Bit Name	Description	R/W	InitVal
4-0	NDIV	DPLL N parameter	R/W	00011
7-5	Reserved	-	-	-
13-8	MDIV	DPLL M parameter	R/W	10011
14	MNEN	MDIV and NDIV write enable,0 disable ,1 enable	R/W	0
31-15	Reserved	-	-	0

**Memory parameter Register (MEM\_REG)**

Bit	Bit Name	Description	R/W	InitVal
2-0	MEMDIV	MEM clock ,000:DPLL/1, 001: DPLL/1.5, 010: DPLL/2,011:DPLL/2.5, 100:DPLL/3,101:DPLL/4, 110:DPLL/6, 111:DPLL/8	R/W	000
3	MEMDIVEN	Enable MEMDIV writw,0 disable ,1 enable	R/W	0
7-4	Reserved	-	-	-

**CPU parameter Register (CPU\_REG)**

Bit	Bit Name	Description	R/W	InitVal
2-0	CPUDIV	CPU clock ,000:DPLL/1, 001: DPLL/1.5, 010: DPLL/2,011:DPLL/2.5, 100:DPLL/3,101:DPLL/4, 110:DPLL/6, 111:DPLL/8	R/W	000
3	CPUDIVEN	Enable CPUDIV writw,0 disable ,1 enable	R/W	0
7-4	Reserved	-	-	-

## 6. Interrupt Controller

RTL8181 provides six hardware-interrupt inputs IRQ0-IRQ5 internally. Some devices will share the same IRQ signal. Following table displays the IRQ map used by devices:

IRQ Number	Interrupt Source
0	Timer/Counter interrupt
1	GPIO/LBC interrupt
2	WLAN interrupt
3	UART/PCI interrupt
4	Ethernet0 interrupt
5	Ethernet1 interrupt

There are two registers for the interrupt control. The **GIMR** register can enable/disable the interrupt source. The **GISR** shows the pending interrupt status.

**Interrupt Control Register Set**

Virtual address	Size (byte)	Name	Description
0xBD01_0000	2	GIMR	Global interrupt mask register
0xBD01_0004	2	GISR	Global interrupt status register

**Global Interrupt Mask Register (GIMR)**

Bit	Bit Name	Description	R/W	InitVal
0	TCIE	Timers/Counters interrupt enable. 0: Disable, 1: Enable	R/W	0
1	GPIOIE	GPIO interrupt enable. 0: Disable, 1: Enable	R/W	0
2	WLAIE	WLAN controller interrupt enable. 0: Disable, 1: Enable	R/W	0
3	UARTIE	UART interrupt enable. 0: Disable 1: Enable	R/W	0
4	ETH0IE	Ethernet0 interrupt enable. 0: Disable, 1: Enable	R/W	0
5	ETH1IE	Ethernet1 interrupt enable. 0: Disable, 1: Enable	R/W	0
6	PCIIE	PCI interrupt enable. 0: Disable, 1: Enable	R/W	0
7	Reserved			
8	LBCIE	LBC time-out interrupt enable. 0: Disable, 1: Enable	R/W	0

**Global Interrupt Status Register (GISR)**

Bit	Bit Name	Description	R/W	InitVal
0	TCIP	Timers/Counters interrupt pending flag. 0: no pending, 1: pending	R	0
1	GPIOIP	GPIO interrupt pending flag 0: no pending, 1: pending	R	0
2	WLAIP	WLAN controller interrupt pending flag. 0: no pending, 1: pending	R	0
3	UARTIP	UARTI interrupt pending flag. 0: no pending, 1: pending	R	0
4	ETH0IP	Ethernet0 interrupt pending flag. 0: no pending, 1: pending	R	0
5	ETH1IP	Ethernet1 interrupt pending flag. 0: no pending, 1: pending	R	0
6	PCIIP	PCI interrupt pending flag. 0: no pending, 1: pending	R	0
7	Reserved			
8	LBCIP	LBC time-out interrupt pending flag. 0: no pending, 1: pending	R	0

## 7. Memory Controller

RTL8181 provides a memory control module that could access external asynchronous SDRAM and flash memory.

RTL8181 could interface to PC100 or PC133-compliant SDRAM, and supports with auto-refresh mode, which requires 4096-cycle refresh in 64 ms. The SDRAM could be accessed in two banks (CS0#, and CS1#), and its size and timing are configurable in register. The data width of SDRAM could be chosen as 16-bit or 32-bit in register as well. If 32-bit is configured, 2 banks of 16-bit SDRAM may be used to expand its data width to 32 bits or use one bank of 32-bit SDRAM is allowable.

[www.DataSheet4U.com](http://www.DataSheet4U.com)

Besides, RTL8181 could also support two banks (F\_CS0# and F\_CS1#) access for flash memory. The system will always boot up from bank 0. The boot bank is mapped to KSEG1 and its beginning physical address at 0xBFC0\_0000 (physical address: 0x1FC0\_0000). Bank 1 flash memory will be mapped to the address "0x1FC0\_000 + flash size". The flash size is configurable from 1M to 8M bytes for each bank. If flash size set to 4M or 8M the 0xBFC0\_0000 still map the first 4M bytes of flash. There will have a new memory mapping from 0xBE00\_0000. The 0xBE00\_0000 mapped to the bank 0 byte 0.

**Memory Configuration Register Set**

Virtual address	Size (byte)	Name	Description
0xBD01_1000	4	MCR	Memory Configuration Register
0xBD01_1004	4	MTCR0	Memory Timing Configuration Register 0
0xBD01_1008	4	MTCR1	Memory Timing Configuration Register 1

Note: These three registers should be accessed in double word.

**Memory Configuration Register (MCR)**

Bit	Bit Name	Description	R/W	InitVal
31-30	FLSIZE	Flash size respective to one bank (byte). 00: 1M, 01: 2M, 10: 4M, 11: 8M	R/W	11
29-28	SDRSIZE	SDRAM size respective to one bank (bit). 00: 512Kx16x2, 01: 1Mx16x4, 10: 2Mx16x4, 11: Reserved	R/W	01
27	CAS	CAS Latency 0: Latency=2, 1: Latency=3	WR	0
26-25	FLBK0BW	Flash bank 0 bus width. 01: 16 bit	R	
24-23	FLBK1BW	Flash bank 1 bus width 00 11 10: reserved, 01: 16 bit	W/R	01
22-21	-	Reserved		
20	SDBUSWID	SDRAM bus width 0: 16 bit, 1: 32 bit	W/R	1 0
19	MCK2LCK	Memory clock mode. Power on latch from GPIOB[13]. 1: Memory clock is the same as CPU clock. 0: memory clock following the power on latch from SYSCFG[3-0].	R	
18-16	BUSCLK	Bus Clock to control auto-refresh timing 000:200, 001:100, 010:50, 011:25, 100:12.5, 101:6.25 110: 3.125, 111: 1.5625 MHz	R/W	000
15-0	Reserved	Must be set to bit value 00.	R/W	00

**Memory Timing Configuration Register 0 (MTCR0)**

Bit	Bit Name	Description	R/W	InitVal
31-28	CE0T_CS	The timing interval between F_CE0# to WR# Basic unit, 2*clock cycle "0000" means 1 unit (2 clock cycles)	R/W	1111
27-24	CE0T_WP	The timing interval for WR# to be pulled-low Basic unit, 2*clock cycle "0000" means 1 unit (2 clock cycles)	R/W	1111
23-20	CE1T_CS	The timing interval between F_CE1# to WR# Basic unit, 2*clock cycle "0000" means 1 unit (2 clock cycles)	R/W	1111
19-16	CE1T_WP	The timing interval for WR# to be pulled-low Basic unit, 2*clock cycle "0000" means 1 unit (2 clock cycles)	R/W	1111
15-0	-	Reserved		

Note: The clock cycle is based memory clock.

**Memory Timing Configuration Register 1 (MTCR1)**

Bit	Bit Name	Description	R/W	InitVal
-----	----------	-------------	-----	---------

12-10	CE23T_RP=T_RCD	T_RP and T_RCD timing parameter Basic unit, 1*clock cycle “0000” means 1 unit (1 clock cycle)	R/W	111
9-5	CE23T_RAS	T_RAS timing parameter Basic unit, 1*clock cycle “0000” means 1 unit (1 clock cycle)	R/W	11111
4-0	CE23T_RFC	T_RFC timing parameter for refresh interval Basic unit, 1*clock cycle “0000” means 1 unit (1 clock cycle)	R/W	11111

Note: The clock cycle is based memory clock.

**The SDRAM timing:**

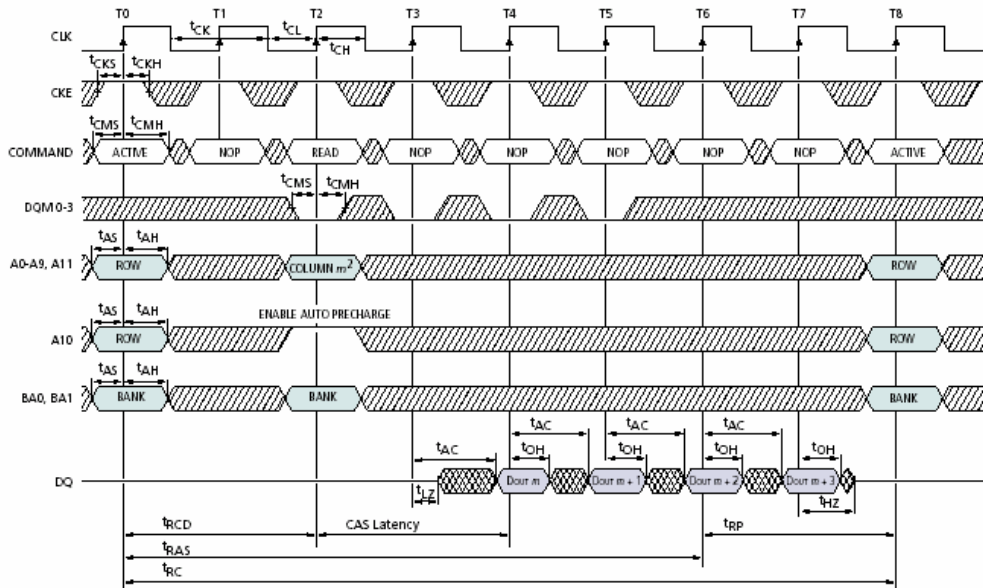

**The write access timing of flash memory:**

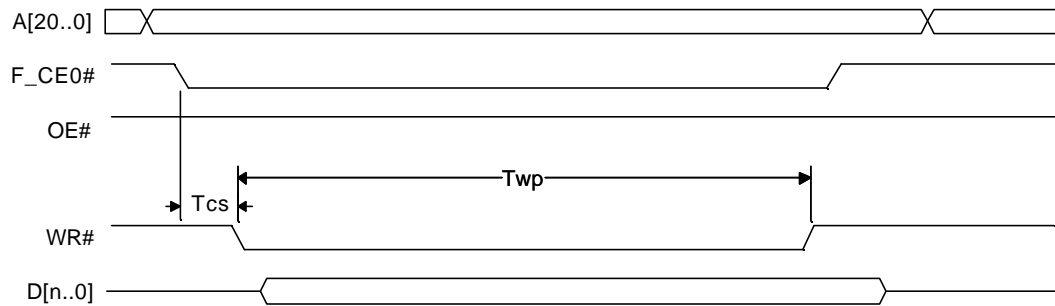

The read access timing of flash memory:

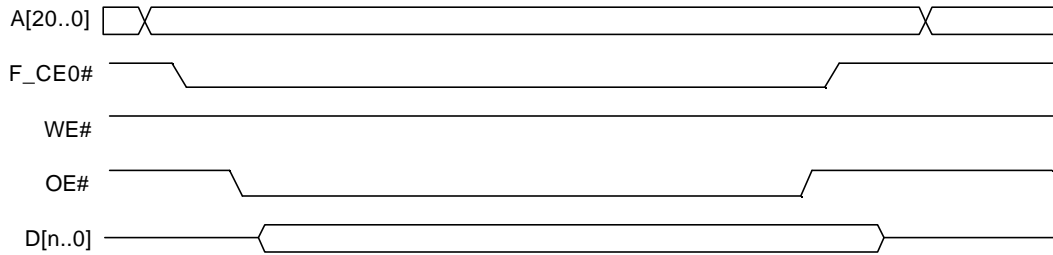

## 8. Ethernet Controller

There are two 10/100M Ethernet MAC embedded in RTL8181. The Ethernet device has bus master capability, which will move packets between SDRAM and Ethernet controller through DMA mechanism. Thus, it could offload the CPU loading and get better performance. Besides, it also supports full-duplex operation, making possible 200Mbps bandwidth at no additional cost.

### Ethernet 0 Register Set (LAN PORT)

Virtual Address	Size (byte)	Name	Description	Access
0xBD20_0000	4	ETH0_CNRI	Control register 1	R/W
0xBD20_0004	6	ETH0_ID	NIC ID	R/W
0xBD20_000C	8	ETH0_MAR	Multicast register	R/W
0xBD20_0014	4	ETH0_TSAD	Transmit Starting Logic Address of Descriptor	R/W
0xBD20_0018	4	ETH0_RSAD	Receive Starting Logic Address of Descriptor	R/W
0xBD20_0020	2	ETH0_IMR	Ethernet0 Interrupt Mask Register	R/W
0xBD20_0024	2	ETH0_ISR	Ethernet0 Interrupt Status Register	R/W
0xBD20_0028	4	ETH0_TMF0	Type match filter 0 register	R/W
0xBD20_002C	4	ETH0_TMF1	Type match filter 1 register	R/W
0xBD20_0030	4	ETH0_TMF2	Type match filter 2 register	R/W
0xBD20_0034	4	ETH0_TMF3	Type match filter 3 register	R/W
0xBD20_0038	4	ETH0_MII	MII access register	R/W
0xBD20_003C	4	ETH0_CNRI2	NIC control register 2	R/W
0xBD20_0040	16	ETH0_UAR	Unicast address filter register	R/W
0xBD20_0080	3	ETH0_MPC	Indicates the number of packets discarded due to rx FIFO overflow. It is a 24-bit counter. It is cleared to zero by read command.	R
0xBD20_0084	2	ETH0_TXCOL	Transmit collision counter. This 16-bit counter increments by 1 for every collision event. It rolls over when becomes full. It is cleared to zero by read command.	R
0xBD20_0088	2	ETH0_RXER	Receive error count. This 16-bit counter increments by 1 for each valid packet received. It is cleared to zero by read command.	R

### Ethernet 1 Register Set (WAN PORT)

Virtual Address	Size (byte)	Name	Description	Access
0xBD30_0000	4	ETH1_CNRI	Control register 1	R/W
0xBD30_0004	6	ETH1_ID	NIC ID	R/W
0xBD30_000C	8	ETH1_MAR	Multicast register	R/W

0xBD30_0014	4	ETH1_TSAD	Transmit Starting Logic Address of Descriptor	R/W
0xBD30_0018	4	ETH1_RSAD	Receive Starting Logic Address of Descriptor	R/W
0xBD30_0020	2	ETH1_IMR	Ethernet0 Interrupt Mask Register	R/W
0xBD30_0024	2	ETH1_ISR	Ethernet0 Interrupt Status Register	R/W
0xBD30_0028	4	ETH1_TMF0	Type match filter 0 register	R/W
0xBD30_002C	4	ETH1_TMF1	Type match filter 1 register	R/W
0xBD30_0030	4	ETH1_TMF2	Type match filter 2 register	R/W
0xBD30_0034	4	ETH1_TMF3	Type match filter 3 register	R/W
0xBD30_0038	4	ETH1_MII	MII access register	R/W
0xBD30_003C	4	ETH1_CNR2	NIC control register 2	R/W
0xBD30_0080	3	ETH1_MPC	Indicates the number of packets discarded due to rx FIFO overflow. It is a 24-bit counter. It is cleared to zero by read command.	R
0xBD30_0084	2	ETH1_TXCOL	Transmit collision counter. This 16-bit counter increments by 1 for every collision event. It rolls over when becomes full. It is cleared to zero by read command.	R
0xBD30_008C	2	ETH1_RXER	Receive error count. This 16-bit counter increments by 1 for each valid packet received . It is cleared to zero by read command.	R

**Ethernet Control Register 1 (ETH0\_CNR1, ETH1\_CNR1)**

Bit	Bit Name	Description	R/W	InitVal
31-29	RXBLEN	Rx Burst length on Lexra bus. 000 - 010 = 64 bytes	R/W	000
28-26	TXBLEN	Tx Burst length on Lexra bus. 000 = 16 bytes 001 = 32 bytes 010 = 64 bytes	R/W	000
25	FIFOAddrPtr	FIFO Address Pointer: (Realtek internal use only to test FIFO SRAM) 0: Both Rx and Tx FIFO address pointers are updated in ascending way from 0 and upwards. The initial FIFO address pointer is 0. 1: Both Rx and Tx FIFO address pointers are updated in descending way from 1FFh and downwards. The initial FIFO address pointer is 1FFh.	R/W	0
24	TDFN	Tx Descriptor Fetch Notify. Set this bit to notify the NIC to fetch the Tx descriptors. The NIC will clear this bit automatically after all packets have been transmitted. Writing 0 to this bit has no effect.	W	0
20	RST	Reset. A soft reset which disable the transmitter and receiver, re-initializes the FIFOs, and buffer pointer to the initial value.	W	0
19	RE	Receiver enable.	R/W	0
18	TE	Transmitter enable.	R/W	0
17	TxFCE	Transmit flow control enable.	R/W	0
16	RxFCE	Receive flow control enable	R/W	0
15	Reserved			0
14	RxVLAN	Receive VLAN un-tagging enable	R/W	0
13	RxChkSum	Receive checksum offload enable	R/W	0

12	FSWIntom	Forced software interrupt. Writing 1 to this bit will trigger an interrupt, and the SWIP bit will be set. The NIC will clear this bit automatically after SWIP bit is cleared. Writing 0 to this bit has no effect.	W	
11-10	LBK[1:0]	Loopback test. Setting both bits will route all transmit traffic from Tx FIFO to Rx FIFO 00: normal operation 01, 10: reserved 11: loopback mode	R/W	00
9	NoCRC	No CRC. 0: CRC appended 1: no CRC appended	R/W	0
8	AER	Accept error packets	R/W	0
7	AB	Accept Broadcast packets	R/W	0
6	AM	Accept Multicast packets	R/W	0
5	APM	Accept Physical address Matched packets	R/W	0
4	AAP	Accept All Physical packets	R/W	0
3	ATM	Accept Type match packets. This bit enables the qualification of types of received packets.	R/W	0
2	AR	Accept runt packets	R/W	0
1	ALEN	Accept length specific packets. This bit is effective when ATM bit is set. 0: filter length specific packets. 1: accept length specific packets.	R/W	0

**Ethernet Control Register 2 (ETH0\_CN2, ETH1\_CN2)**

Bit	Bit Name	Description	R/W	InitVal
16	UAEN	Unicast address filter enable (note). 0: disabled. 1: enabled.	R/W	0
15	TXPON	Send Pause On packet. Write "1" to send Pause On packet.	W	0
14	TXPOFF	Send Pause Off packet. Write "1" to send Pause Off packet.	W	0
13	TXPF	Send Pause flag. Set, when NIC sends Pause-On packet. Reset, when NIC sends Pause-Off packet.	R	0
12	RXPF	Receive Pause Flag: Set, when NIC is in backoff state because a pause packet received. Reset, when pause state is clear.	R	0
11-8	PTMASK[3:0]	Pause time mask. These bits mask the most significant four bits of pause time 0xFFFF used for a PAUSE packet. For example, if PTMASK[3:0] is set to 0x01, a PAUSE packet with pause time 0x1FFF will be sent when descriptor unavailable condition occurs.	R/W	1111
6-4	IFG[2:0]	InterFrameGap Time: This field allows the user to adjust the interframe gap time longer than the standard: 9.6 us for 10Mbps, 960 ns for 100Mbps. The time can be programmed from 9.6 us to 14.4 us (10Mbps) and 960ns to 1440ns (100Mbps). The formula for the inter frame gap is 011: 9.6us/ 960ns 100: 9.6+4*0.1us/ 960+4*10ns 101: 9.6+8*0.1us/ 960+8*10ns 110: 9.6+12*0.1us/ 960+12*10ns 111: 9.6+16*0.1us/ 960+16*10ns	R/W	011

www.DataSheet4U.com

		000: 9.6+20*0.1us/ 960+20*10ns 001: 9.6+24*0.1us/ 960+24*10ns 010: 9.6+48*0.1us/ 960+48*10ns		
3-0	TXRR[3:0]	Tx Retry Count: These are used to specify additional transmission retries in multiple of 16(IEEE 802.3 CSMA/CD retry count). If the TXRR is set to 0, the transmitter will re-transmit 16 times before aborting due to excessive collisions. If the TXRR is set to a value greater than 0, the transmitter will re-transmit a number of times equals to the following formula before aborting: Total retries = 16 + TXRR The TER bit in the ISR register or transmit descriptor will be set when the transmission fails and reaches to this specified retry count.	R/W	0

Note: Bit UAEN is only existed in ETH0\_CNFR2 register.

**Unicast Address Filter Register (ETH0\_UAR)**

Bit	Bit Name	Description	R/W	InitVal
127-0	UARTBL	Unicast address hash table. If the 'n' bit value is set '1', it implies the receiving frames which hash value with 'n' will be indicated.	R/W	0

**Interrupt Mask Register (ETH0\_IMR, ETH1\_IMR)**

Bit	Bit Name	Description	R/W	InitVal
9	LINKCHGIE	Link status changed interrupt enable	R/W	0
8	RERIE	Rx error interrupt enable	R/W	0
7	TERIE	Tx error interrupt enable	R/W	0
6	ROKIE	ROK interrupt enable. A descriptor reception is completed successfully.	R/W	0
5	TOKIE	TOK interrupt enable. A descriptor transmission is completed successfully.	R/W	0
4	RFOVWIE	Rx FIFO overflow interrupt enable	R/W	0
3	RDUIE	Rx descriptor unavailable interrupt enable. Set when the Rx Descriptors have been exhausted.	R/W	0
2	Reserved			
1	TDUIE	Tx descriptor unavailable interrupt enable	R/W	0
0	SWIE	Software interrupt enable	R/W	0

**Interrupt Status Register (ETH0\_ISR, ETH1\_ISR)**

Bit	Bit Name	Description	R/W	InitVal
9	LINKCHGIP	Link status changed interrupt pending flag. Write "1" to clear the interrupt.	R/W	0
8	RERIP	Rx error interrupt pending flag. Write "1" to clear the interrupt.	R/W	0
7	TERIP	Tx error interrupt enable flag. Write "1" to clear the interrupt.	R/W	0
6	ROKIP	ROK interrupt pending. A descriptor reception is completed successfully. Write "1" to clear the interrupt.	R/W	0
5	TOKIP	TOK interrupt pending. A descriptor transmission is completed successfully. Write "1" to clear the interrupt.	R/W	0
4	RFOVWIP	Rx FIFO overflow interrupt pending Write "1" to clear the interrupt..	R/W	0
3	RDUIP	Rx descriptor unavailable interrupt pending. Set when the Rx Descriptors have been exhausted. Write "1" to clear the interrupt and it also trigger	R/W	0



2	Reserved			
1	TDUIP	Tx descriptor unavailable interrupt pending flag. Write "1" to clear the interrupt.	R/W	0
0	SWIP	Software interrupt pending flag. Write "1" to clear the interrupt.	R/W	0

**MII Access Register (ETH0\_MII, ETH1\_MII)**

Bit	Bit Name	Description	R/W	InitVal
31-22	-	Reserved		
21	MMIMODE	Mode of MII management interface. (Realtek internal use only to test 3-port switch) 0 = auto mode. The NIC controls MDC and MDIO pins. Setting this bit will trigger an auto-negotiation if DisNway bit is cleared. 1 = manual mode. The software controls MDC and MDIO pins.	R/W	0
20-16	PHYAD[4:0]	PHY address.	R/W	0x01
15	LinkCtrl	Link control. 0: force link down. 1: force link up.	R/W	0
14	DplxCtrl	Duplex control. When DuplexCtrl bit is cleared, this bit is read only. The NIC will poll its local PHY regularly. This bit will reflect the result of auto-negotiation from its local PHY. If FDuplex is set, this bit is writable. The software may program the bit and force the MII operates in full-duplex or half-duplex mode. 0: Force half-duplex mode. 1: Force full-duplex mode.	R/W	1
13	SpdCtrl	Speed control. 0: 10Mbps 1: 100Mbps.	R/W	1
12	FI Ctrl	Flow control. 0: disable flow control. 1: enable flow control.	R/W	0
11	LinkSt	Link status. This bit reflects the link status from its local PHY. 0: link down 1: link up	R	0
10	DuplexSt	Duplex status. This bit reflects the duplex status from its local PHY. 0: half duplex	R	0
9	SpeedSt	Speed status. This bit reflects the link speed from its local PHY. 0: 10Mbps 1: 100Mbps	R	0
8	FI Ctrl St	Flow control status 0: flow control disabled 1: flow control enabled.	R	0
7-5	-	Reserved		
4	DisNway	Disable N-way 0: auto-negotiation mode. The local PHY will advertise its capability per the settings of DplxCtrl, SpdCtrl, and FI Ctrl bits. 1: forced mode (disable N-way). The software may force MII operating mode by writing the corresponding value to the DplxCtrl, LinkCtrl, SpdCtrl, FI Ctrl bits.	R/W	0

3	MDM	Management Data Mode: 0: MDIO pin is input. MDI bit reflects the state of MDIO pin. The default value is "0". 1: MDIO pin is output, and the state of MDIO pin reflects with MDO bit.	R/W	0
2	MDO	MII Management Data-OUT: Used by the NIC to write data to the MDIO pin.	R/W	X
1	MDI	MII Management Data-IN: Used by the NIC to read data from the MDIO pin.	R	X
0	MDC	Management Data Clock: This bit reflects the state of MDC pin.	R/W	0

### Transmit Descriptor

Tx Descriptor Format (before transmitting, OWN=1, LGSEN=0, Tx command mode 1)

31	30	29	28	27	26	25	24	23	22	21	20	19	18	17	16	15	14	13	12	11	10	9	8	7	6	5	4	3	2	1	0
O	E	F	L	L	R	R	R	R	R	R	R	R	I	U	T												Offset 0				
W	O	S	S	G	E	E	E	E	E	E	E	E	P	D	C												Frame_Length				
N	R			S	S	S	S	S	S	S	S	S	C	P	P																
=				E	V	V	V	V	V	V	V	V	S	C	C																
1				N	=	0							S	S																	
RESV													TAGC	VLAN_TAG											Offset 4						
TX_BUFFER_ADDRESS																											Offset 8				
Dummy																											Offset 12				

Byte Offset#	Bit#	Bit Name	Description
0	31	OWN	When set, indicates that the descriptor is owned by NIC, and the data relative to this descriptor is ready to be transmitted. When cleared, indicates that the descriptor is owned by host system. NIC clears this bit when the relative buffer data is transmitted. In this case, OWN=1.
0	30	EOR	End of descriptor Ring. When set, indicates that this is the last descriptor in descriptor ring. When NIC's internal transmit pointer reaches here, the pointer will return to the first descriptor of the descriptor ring after transmitting the data relative to this descriptor.
0	29	FS	First segment descriptor. When set, indicates that this is the first descriptor of a Tx packet, and this descriptor is pointing to the first segment of the packet.
0	28	LS	Last segment descriptor. When set, indicates that this is the last descriptor of a Tx packet, and this descriptor is pointing to the last segment of the packet.
0	27	LGSEN	A command bit. TCP/IP-Large-send operation enables. Driver sets this bit to enable NIC to offload CPU operation for TCP/IP fragmentation.
0	26-19	-	Reserved.
0	18	IPCS	A command bit. IP checksum offload. Driver sets this bit to ask NIC to offload IP checksum.
0	17	UDPCS	A command bit. UDP checksum offload. Driver sets this bit to ask NIC to offload UDP checksum.
0	16	TCPCS	A command bit. TCP checksum offload enable. Driver sets this bit to ask NIC to offload TCP checksum.

0	15-0	Frame_Length	Transmit frame length. This field indicates the length in TX buffer, in byte, to be transmitted
4	31-18	RSEV	Reserved.
4	17-16	TAGC	VLAN tag control bits: 00: Packet remains unchanged when transmitting 10: Add TAG. 0x8100 (Ethernet encoded tag protocol ID, indicating that this is a IEEE 802.1Q VLAN packet) is inserted after source address, and 2 bytes are inserted after tag protocol ID from VLAN_TAG field in transmit descriptor.
4	15-0	VLAN_TAG	The 2-byte VLAN_TAG contains information, from upper layer, of user priority, canonical format indicator, and VLAN ID. Please refer to IEEE 802.1Q for detailed VLAN tag information.
8	31-0	TxBuff	Logic Address of transmission buffer.

Tx Status Descriptor (after transmitting, OWN=0, Tx status mode) After having transmitted, the Tx descriptor turns to be a Tx status descriptor.

31	30	29	28	27	26	25	24	23	22	21	20	19	18	17	16	15	14	13	12	11	10	9	8	7	6	5	4	3	2	1	0								
O	E	F	L	R	R	U	R	T	O	L	E	CC3-0															Frame_Length												Offset 0
W	O	S	S	E	E	N	E	E	W	N	X																												
N	R			S	S	F	S	S	C	K	C																												
=				V	V	V																																	
0																																							
RESV												TAGC	VLAN_TAG															Offset 4											
TX_BUFFER_ADDRESS																															Offset 8								
Dummy																															Offset 12								

Byte Offset#	Bit#	Bit Name	Description
0	31	OWN	When set, indicates that the descriptor is owned by NIC. When clear indicates that the descriptor is owned by host system. NIC clears this bit when the relative buffer data is already transmitted. In this case, OWN=0.
0	30	EOR	End of descriptor Ring. When set, indicates that this is the last descriptor in descriptor ring. When NIC's internal transmit pointer reaches here, the pointer will return to the first descriptor of the descriptor ring after transmitting the data relative to this descriptor.
0	29	FS	First segment descriptor. When set, indicates that this is the first descriptor of a Tx packet, and this descriptor is pointing to the first segment of the packet.
0	28	LS	Last segment descriptor. When set, indicates that this is the last descriptor of a Tx packet, and this descriptor is pointing to the last segment of the packet.
0	27-26	-	Reserved.
0	25	UNF	FIFO underrun. A status bit. NIC sets this bit to inform driver that FIFO underrun had ever occurred before this packet transmitted.
0	24	-	Reserved.
0	23	TES	Transmit Error Summary. When set, indicates that at least one of the following errors occurred: OWC, EXC, LNKF. This bit is valid only when LS (Last segment bit) is set.

0	22	OWC	Out of Window Collision. A status bit. Out of window collision, When set, it means an “out-of-window” collision is encountered during transmitting packet.
0	21	LNKF	Link Failure. A status bit. NIC sets this bit to inform link failure to driver
0	20	EXC	Excessive Collision. When set, indicates that the transmission was aborted owing to consecutive 16 collisions.
0	19-16	CC3-0	Collision Counter. When Own bit =0, it’s a status field, A 4-bit collision counter, shows the total collision times before the packet was transmitted.
0	23-16	-	Reserved.
0	15-0	Frame_Length	Transmit frame length. This field indicates the length in TX buffer, in byte, to be transmitted
4	31-18	RSEV	Reserved.
4	17-16	TAGC	VLAN tag control bits: 00: Packet remains unchanged when transmitting. 10: Add TAG. 0x8100 (Ethernet encoded tag protocol ID, indicating that this is an IEEE 802.1Q VLAN packet) is inserted after source address, and 2 bytes are inserted after tag protocol ID from VLAN_TAG field in transmit descriptor.
4	15-0	VLAN_TAG	The 2-byte VLAN_TAG contains information, from upper layer, of user priority, canonical format indicator, and VLAN ID. Please refer to IEEE 802.1Q for detailed VLAN tag information.
8	31-0	TxBuff	Logic Address of transmission buffer.

### Reception Descriptor

Rx Command Descriptor (OWN=1)

31	30	29	28	27	26	25	24	23	22	21	20	19	18	17	16	15	14	13	12	11	10	9	8	7	6	5	4	3	2	1	0
O		RESV																Buffer_Size													Offset 0
E		RESV																VLAN_TAG													Offset 4
W		RESV																RX_BUFFER_ADDRESS													Offset 8
O		RESV																Dummy													Offset 12
N		RESV																													
R		RESV																													
=		RESV																													
1		RESV																													

Byte Offset#	Bit#	Bit Name	Description
0	31	OWN	When set, indicates that the descriptor is owned by NIC, and is ready to receive packet. The OWN bit is set by driver after having pre-allocated buffer at initialization, or the host has released the buffer to driver. In this case, OWN=1.
0	30	EOR	End of Rx descriptor Ring. Set to 1 indicates that this descriptor is the last descriptor of Rx descriptor ring. Once NIC’s internal receive descriptor pointer reaches here, it will return to the first descriptor of Rx descriptor ring after this descriptor is used by packet reception.

0	29-13	Reserved	Reserved.
0	12-0	Buffer_Size	This field indicate the receiver buffer size in bytes. Although the maximum buffer size is 8K bytes/buffer, the NIC purges all data after 4K bytes if the packet is larger than 4K-byte long.
4	31-17	RSEV	Reserved.
4	16	TAVA	Tag Available. When set, the received packet is an IEEE802.1Q VLAN TAG (0x8100) available packet.
4	15-0	VLAN_TAG	If the packet 's TAG is 0x8100, The  NIC extracts four bytes from after source ID, sets TAVA bit to 1, and moves the TAG value to this field in Rx descriptor.
8	31-0	RxBuff	Logic Address of receive buffer.

**Rx Status Descriptor (OWN=0)**

31	30	29	28	27	26	25	24	23	22	21	20	19	18	17	16	15	14	13	12	11	10	9	8	7	6	5	4	3	2	1	0
O	E	F	L	F	M	P	B	B	F	R	R	R	C	P	P		U	T	Frame_Length										Offset 0		
W	O	S	S	A	A	A	A	O	O	W	E	U	R	I	I	IP	D	C													
N	R			E	R	M	R	V	V	T	S	N	C	D	D	F	P	P													
=																															
0																															
RESV																T A V A	VLAN_TAG										Offset 4				
RX_BUFFER_ADDRESS																										Offset 8					
Dummy																										Offset 12					

Byte Offset#	Bit#	Bit Name	Description
0	31	OWN	When set, indicates that the descriptor is owned by NIC. When cleared, indicates that the descriptor is owned by host system. NIC clears this bit when NIC has filled up this Rx buffer with a packet or part of a packet. In this case, OWN=0.
0	30	EOR	End of Rx descriptor Ring. Set to 1 indicates that this descriptor is the last descriptor of Rx descriptor ring. Once NIC's internal receive descriptor pointer reaches here, it will return to the first descriptor of Rx descriptor ring after this descriptor is used by packet reception.
0	29	FS	First segment descriptor. When set, indicates that this is the first descriptor of a received packet, and this descriptor is pointing to the first segment of the packet.
0	28	LS	Last segment descriptor. When set, indicates that this is the last descriptor of a received packet, and this descriptor is pointing to the last segment of the packet.
0	27	FAE	Frame Alignment Error. When set, indicates a frame alignment error has occurred on the received packet. The FAE packet is able to be received only when RCR_AER is set.
0	26	MAR	Multicast Address packet Received: When set, indicates that a multicast packet is received
0	25	PAM	Physical Address Matched. When set, indicates that the destination address of this Rx packet matches to the value in NIC 's ID registers.
0	24	BAR	Broadcast Address Received. When set, indicates that a broadcast packet is received. BAR and MAR will not be set simultaneously.

0	23	BOVF	Buffer Overflow. When set, indicates that receive buffer has ever exhausted before this packet is received.
0	22	FOVF	FIFO Overflow. When set, indicates that FIFO overflow has ever occurred before this packet is received.
0	21	RWT	Receive Watchdog Timer expired. When set, indicates that the received packet length exceeds 1724 bytes, the receive watchdog timer will expire and stop receive engine.
0	20	RES	Receive Error Summary. When set, indicates at least one of the following errors occurred: CRC, RUNT, RWT, FAE. This bit is valid only when LS (Last segment bit) is set
0	19	RUNT	Runt packet. When set, indicates that the received packet length is smaller than 64 bytes. RUNT packet is able to be received only when RCR_AR is set.
0	18	CRC	CRC error. When set, indicates that a CRC error has occurred on the received packet. A CRC-error packet can be received only when RCR_AER is set.
0	17-16	PDI[1:0]	Protocol ID1, Protocol ID0 00: Non-IP 01: TCP/IP 10: UDP/IP 11: IP.
0	15	IPF	When set, indicates IP checksum failure.
0	14	UDPF	When set, indicates UDP checksum failure.
0	13	TCPF	When set, indicates TCP checksum failure.
0	12-0	Frame_Le ngth	When OWN=0 and LS =1, it indicates the received packet length including CRC, in bytes.
4	31-17	RSEV	Reserved.
4	16	TAVA	Tag Available. When set, the received packet is an IEEE802.1Q VLAN TAG (0x8100) available packet.
4	15-0	VLAN_T AG	If the packet 's TAG is 0x8100, The NIC extracts four bytes from after source ID, sets TAVA bit to 1, and moves the TAG value to this field in Rx descriptor.
8	31-0	RxBuff	Logic Address of receive buffer.

## 9. UART Controller

RTL8181 provides a 16C550 compatible UART, which contains 16 byte FIFOs. In addition, auto flow control is provided, in which, auto-CTS mode (CTS controls transmitter) and auto-RTS mode (Receiver FIFO contents and threshold control RTS) are both supported. The baud rate is programmable and allows division of any input reference clock by 1 to (2<sup>16</sup>-1) and generates an internal 16x clock. RTL8181 provides fully programmable serial interface, which can be configured to support 7,8 bit characters, even, odd, no parity generation and detection, and 1 or 2 stop bit generation. Last, fully prioritized interrupt control and loopback functionality for diagnostic capability are also provided.

The clock source is 22MHz.

### UART Register Set

Virtual address	Size (byte)	Name	Description	Access
0xBD01_00C3	1	UART_RBR	Receiver buffer register. (DLAB=0)	R
0xBD01_00C3	1	UART_THR	Transmitter holding register. (DLAB=0)	W
0xBD01_00C3	1	UART_DLL	Divisor latch LSB. (DLAB=1)	R/W
0xBD01_00C7	1	UART_IER	Interrupt enable register. (DLAB=0)	R/W
0xBD01_00C7	1	UART_DLM	Divisor latch MSB. (DLAB=1)	R/W
0xBD01_00CB	1	UART_IIR	Interrupt identification register.	R
0xBD01_00CB	1	UART_FCR	FIFO control register	W
0xBD01_00CF	1	UART_LCR	Line control register	R/W
0xBD01_00D3	1	UART_MCR	Modem control register	R/W

0xBD01_00D7	1	UART_LSR	Line status register	R/W
0xBD01_00DB	1	UART_MSR	Modem status register	R/W
0xBD01_00DF	1	UART_SCR	Scratch register	R/W

**Interrupt Enable Register (UART\_IER)**

Bit	Bit Name	Description	R/W	InitVal
7-6	-	Reserved		
5	ELP	Low power mode enable	R/W	0
3	EDSSI	Enable modem status register interrupt	R/W	0
4	ESLP	Sleep mode enable	R/W	0
2	ELSI	Enable receiver line status interrupt	R/W	0
1	ETBEI	Enable transmitter holding register empty interrupt	R/W	0
0	ERBI	Enable received data available interrupt	R/W	0

**Interrupt Identification Register (UART\_IIR)**

Bit	Bit Name	Description	R/W	InitVal
7:5	FIFO64[2:0]	000 = no FIFO 110 = 16-byte FIFO	R	110
4	-	Reserved	R	0
3:1	IID[2:0]	Interrupt ID. IID[1:0] indicates the interrupt priority.	R	000
0	IPND	Interrupt pending 0 = interrupt pending	R	0

**Interrupt Priority**

Interrupt Identification Register				Priority level	Interrupt type	Interrupt source	Interrupt reset method
Bit3	Bit2	Bit1	Bit0				
0	0	0	1	None	None	None	None
0	1	1	0	1	Receiver line status	Overrun, parity, framing errors or break	Read LSR
0	1	0	0	2	Received data available	DR bit is set.	Read RBR.
1	1	0	0	2	Character time-out indication	No characters have been removed from or input to FIFO during the last character times and at 1 character in it.	Read RBR
0	0	1	0	3	Transmitter holding register empty	THRE bit set.	Reading IIR or write THR
0	0	0	0	4	Modem status	CTS#,DSR#,RI#,DCD#	Reading MSR

**FIFO Control Register (UART\_FCR)**

Bit	Bit Name	Description	R/W	InitVal
7-6	RTRG[1:0]	Receiver trigger level Trigger level: 16-byte 00 = 01 01 = 04 10 = 08 11 = 14	W	11
3-5	-	Reserved		
2	TFRST	Transmitter FIFO reset. Writes 1 to clear the transmitter FIFO.	W	0
1	RFRST	Receiver FIFO reset. Writes 1 to clear the receiver FIFO.	W	0
0	EFIFO	Enable FIFO. When this bit is set, enable the	W	0

www.DataSheet4U.com	transmitter and receiver FIFOs. Changing this bit clears the FIFOs.		
---------------------	---	--	--

**Line Control Register (UART\_LCR)**

Bit	Bit Name	Description	R/W	InitVal
7	DLAB	Divisor latch access bit.	R/W	0
6	BRK	Break control. Set this bit force TXD to the spacing (low) state.(break) Clear this bit to disable break condition.	R/W	0
5-4	EPS[1:0]	Even parity select 00 = odd parity 01 = even parity 10 = mark parity 11 = space parity	R/W	0
3	PEN	Parity enable	R/W	0
2	STB	Number of stop bits 0 = 1 bit 1 = 2 bits	R/W	0
1-0	WLS[1:0]	Word length select 10 = 7 bits 11 = 8 bits	R/W	11

**Modem Control Register (UART\_MCR)**

Bit	Bit Name	Description	R/W	InitVal
7-6	-	Reserved		
5	AFE	Auto flow control enable	R/W	0
4	LOOP	Loopback	R/W	0
2-3	-	Reserved		
1	RTS	Request to send 0 = Set RTS# high 1 = Set RTS# low	R/W	0
0	-	Reserved		

**Line Status Register (UART\_LSR)**

Bit	Bit Name	Description	R/W	InitVal
7	RFE	Errors in receiver FIFO. At least one parity, framing and break error in the FIFO.	R	0
6	TEMT	Transmitter empty Character mode: both THR and TSR are empty. FIFO mode: both transmitter FIFO and TSR are empty	R	0
5	THRE	Transmitter holding register empty. Character mode: THR is empty. FIFO mode: transmitter FIFO is empty	R	0
4	BI	Break interrupt indicator	R	0
3	FE	Framing error	R	0
2	PE	Parity error	R	0
1	OE	Overrun error. An overrun occurs when the receiver FIFO is full and the next character is completely received in the receiver shift register. An OE is indicated. The character in the shift register will be overwritten.	R	0
0	DR	Data ready. Character mode: data ready in RBR FIFO mode: receiver FIFO is not empty.	R	0

**Modem Status Register (UART\_MSR)**

Bit	Bit Name	Description	R/W	InitVal
-----	----------	-------------	-----	---------



7	DCD	In loopback mode, returns the bit 2 of MCR. In normal mode, returns 1.	R	1
6	RI	In loopback mode, returns the bit 3 of MCR. In normal mode, returns 0.	R	0
5	DSR	In loopback mode, returns the bit 0 of MCR In normal mode, returns 1.	R	1
4	CTS	Clear to send. 0 = CTS# detected high 1 = CTS# detected low	R	0
3-1	-	Reserved		
0	?CTS	Delta clear to send. CTS# signal transits.	R	0

## 10. Timer & Watchdog

There are four sets of hardware timer and one watchdog timer. Each timer can be configured as timer mode or counter mode. No matter counter or timer mode, the time value will be counted down from initial value to zero, which value is subtracted by one in every timer clock. When configured as timer mode, the source of timer clock could be configured to use base clock directly, or based on the base clock divided by a configurable register value – CDBR, which way is called as Basic timer. When the value is reaching to zero, the timer is stopped and an interrupt will be issued in counter mode. If configured as timer mode, beside to issue an interrupt, the time value will be reset to its initial value, and then count down timer be operated continuously, and an interrupt will be issued periodically whenever the count down value reaches to zero.

When watchdog timer is enabled, it will cause the system reset when time out occurred. The time out interval could be selected from register, the time unit value is based on base clock divided by the base value, which is same used by timer.

### Timer & Watchdog Register Set

Virtual address	Size (byte)	Name	Description	Access
0xBD01_0050	2	TCCNR	Timer/Counter control register	R/W
0xBD01_0054	1	TCIR	Timer/Counter interrupt register	R/W
0xBD01_0058	1	CDBR	Clock division base register	R/W
0xBD01_005C	2	WDTCSR	Watchdog timer control register	R/W
0xBD01_0060	3	TC0DATA	Timer/Counter 0 data register. It specifies the time-out duration.	R/W
0xBD01_0064	3	TC1DATA	Timer/Counter 1 data register. It specifies the time-out duration.	R/W
0xBD01_0068	4	TC2DATA	Timer/Counter 2 data register. It specifies the time-out duration.	R/W
0xBD01_006C	4	TC3DATA	Timer/Counter 3 data register. It specifies the time-out duration.	R/W
0xBD01_0070	3	TC0CNT	Timer/Counter 0 count register	R
0xBD01_0074	3	TC1CNT	Timer/Counter 1 count register	R
0xBD01_0078	4	TC2CNT	Timer/Counter 2 count register	R
0xBD01_007C	4	TC3CNT	Timer/Counter 3 count register	R

### Timer/Counter 0 Data register (TC0CNT)

Bit	Bit Name	Description	R/W	InitVal
23-0	TC0Value[23:0]	The timer or counter initial value	R/W	

### Timer/Counter 1 Data register (TC1CNT)

Bit	Bit Name	Description	R/W	InitVal
23-0	TC1Value[23:0]	The timer or counter initial value	R/W	

### Timer/Counter 2 Data register (TC2CNT)

Bit	Bit Name	Description	R/W	InitVal
31-0	TC2Value[31:0]	The timer or counter initial value	R/W	

**Timer/Counter 3 Data register (TC3CNT)**

Bit	Bit Name	Description	R/W	InitVal
31-0	TC3Value[31:0]	The timer or counter initial value	R/W	

**Timer/Counter Control register (TCCNR)**

Bit	Bit Name	Description	R/W	InitVal
11	TC3Src	Timer/Counter 3 clock source 0=Base clock 1=Basic timer	R/W	0
10	TC2Src	Timer/Counter 2 clock source 0=Base clock 1=Basic timer	R/W	0
9	TC1Src	Timer/Counter 1 clock source 0=Base clock 1=Basic timer	R/W	0
8	TC0Src	Timer/Counter 0 clock source 0=Base clock 1=Basic timer	R/W	0
7	TC3Mode	Timer/Counter 3 mode 0=counter mode 1=timer mode	R/W	0
6	TC3En	Timer/Counter 3 enable	R/W	0
5	TC2Mode	Timer/Counter 2 mode 0=counter mode 1=timer mode	R/W	0
4	TC2En	Timer/Counter 2 enable	R/W	0
3	TC1Mode	Timer/Counter 1 mode 0=counter mode 1=timer mode	R/W	0
2	TC1En	Timer/Counter 1 enable	R/W	0
1	TC0Mode	Timer/Counter 0 mode 0=counter mode 1=timer mode	R/W	0
0	TC0En	Timer/Counter 0 enable	R/W	0

**Timer/Counter Interrupt Register (TCIR)**

Bit	Bit Name	Description	R/W	InitVal
7	TC3IP	Timer/Counter 3 interrupt pending. Write "1" to clear the interrupt.	R/W	0
6	TC2IP	Timer/Counter 2 interrupt pending. Write "1" to clear the interrupt.	R/W	0
5	TC1IP	Timer/Counter 1 interrupt pending. Write "1" to clear the interrupt.	R/W	0
4	TC0IP	Timer/Counter 0 interrupt pending. Write "1" to clear the interrupt.	R/W	0
3	TC3IE	Timer/Counter 3 interrupt enable	R/W	0
2	TC2IE	Timer/Counter 2 interrupt enable	R/W	0
1	TC1IE	Timer/Counter 1 interrupt enable	R/W	0
0	TC0IE	Timer/Counter 0 interrupt enable	R/W	0

**Clock Division Base Register (CDBR)**

Bit	Bit Name	Description	R/W	InitVal
15-0	DivFactor	The divided factor of clock source. If DivFactor is N, the watchdog timer divide by N+1. This value could not be 0 in timer mode or watchdog. The clock source is 22MHz.	R/W	0

**Watchdog Control Register (WDTCSR)**

Bit	Bit Name	Description	R/W	InitVal
10-9	OVSEL[1:0]	Overflow select. These bits specify the overflow condition when the watchdog timer counts to the value. 00 = $2^{13}$ 01 = $2^{14}$ 10 = $2^{15}$ 11 = $2^{16}$	R/W	00
8	WDTCLR	Watchdog clear. Write a 1 to clear the watchdog counter. It is auto cleared after the write.	W	0
7-0	WDTE[7:0]	Watchdog enable. When these bits are set to 0xA5, the watchdog timer stops. Other value can enable the watchdog timer and cause a system reset when an overflow signal occurs.	W	0xA5

## 11. GPIO Control

RTL8181 provides two sets of GPIO pins – **PortA** and **PortB**. **PortA** has 16 pins and **PortB** has 16 pins. Every GPIO pin can be configured as input or output pins via register **PA(B)DIR**. Register **PA(B)DATA** could be used to control the signals (high or low) of GPIO pins. Because the GPIO pins might be shared with some peripheral pins, the **PA(B)CNR** can control the attribute of the shared pins. Besides, **PortB** GPIO sets can be used to generate interrupt via **PBIMR**, and the interrupt status is shown in **PBISR**.

### GPIO Register Set

Virtual address	Size (byte)	Name	Description	Access
0xBD01_0040	4	PABDIR	Port A/B direction register	R/W
0xBD01_0044	4	PABDATA A	Port A/B data register	R/W
0xBD01_0048	4	PBIMR	Port B interrupt mask register	R/W
0xBD01_004C	4	PBISR	Port B interrupt register	R

### Port A,B Direction Register (PADIR, PBDIR)

Bit	Bit Name	Description	R/W	InitVal
31-16	DRCA[15:0]	Pin direction configuration of Port A 0 = configured as input pin 1 = configured as output pin	R/W	00
15-0	DRCB[15:0]	Pin direction configuration of Port B 0 = configured as input pin 1 = configured as output pin	R/W	00

### Port A,B DATA Register (PADATA, PBDATA)

Bit	Bit Name	Description	R/W	InitVal
31-16	DATAA[15:0]	Pin data of Port A	R/W	00
15-0	DATAB[15:0]	Pin data of Port B	R/W	00

### Port B Interrupt Mask Register (PBIMR)

Bit	Bit Name	Description	R/W	InitVal
1-0	PB0IM[1:0]	PortB.0 interrupt mode 00 = disable interrupt 01 = enable falling edge interrupt 10 = enable rising edge interrupt 11 = enable both falling or rising edge interrupt	R/W	00
3-2	PB1IM[1:0]	PortB.1 interrupt mode 00 = disable interrupt 01 = enable falling edge interrupt	R/W	00

[www.DataSheet4U.com](http://www.DataSheet4U.com)

		10 = enable rising edge interrupt 11 = enable both falling or rising edge interrupt		
5-4	PB2IM[1:0]	PortB.2 interrupt mode 00 = disable interrupt 01 = enable falling edge interrupt 10 = enable rising edge interrupt 11 = enable both falling or rising edge interrupt	R/W	00
7-6	PB3IM[1:0]	PortB.3 interrupt mode 00 = disable interrupt 01 = enable falling edge interrupt 10 = enable rising edge interrupt 11 = enable both falling or rising edge interrupt	R/W	00
9-8	PB4IM[1:0]	PortB.4 interrupt mode 00 = disable interrupt 01 = enable falling edge interrupt 10 = enable rising edge interrupt 11 = enable both falling or rising edge interrupt	R/W	00
11-10	PB5IM[1:0]	PortB.5 interrupt mode 00 = disable interrupt 01 = enable falling edge interrupt 10 = enable rising edge interrupt 11 = enable both falling or rising edge interrupt	R/W	00
13-12	PB6IM[1:0]	PortB.6 interrupt mode 00 = disable interrupt 01 = enable falling edge interrupt 10 = enable rising edge interrupt 11 = enable both falling or rising edge interrupt	R/W	00
15-14	PB7IM[1:0]	PortB.7 interrupt mode 00 = disable interrupt 01 = enable falling edge interrupt 10 = enable rising edge interrupt 11 = enable both falling or rising edge interrupt	R/W	00
17-16	PB8IM[1:0]	PortB.8 interrupt mode 00 = disable interrupt 01 = enable falling edge interrupt 10 = enable rising edge interrupt 11 = enable both falling or rising edge interrupt	R/W	00
19-18	PB9IM[1:0]	PortB.9 interrupt mode 00 = disable interrupt 01 = enable falling edge interrupt 10 = enable rising edge interrupt 11 = enable both falling or rising edge interrupt	R/W	00
21-20	PB10IM[1:0]	PortB.10 interrupt mode 00 = disable interrupt 01 = enable falling edge interrupt 10 = enable rising edge interrupt 11 = enable both falling or rising edge interrupt	R/W	00
23-22	PB11IM[1:0]	PortB.11 interrupt mode 00 = disable interrupt 01 = enable falling edge interrupt 10 = enable rising edge interrupt 11 = enable both falling or rising edge interrupt	R/W	00
25-24	PB12IM[1:0]	PortB.12 interrupt mode 00 = disable interrupt 01 = enable falling edge interrupt 10 = enable rising edge interrupt 11 = enable both falling or rising edge interrupt	R/W	00
27-26	PB13IM[1:0]	PortB.13 interrupt mode 00 = disable interrupt	R/W	00

		01 = enable falling edge interrupt 10 = enable rising edge interrupt 11 = enable both falling or rising edge interrupt		
29-28	PB14IM[1:0]	PortB.14 interrupt mode 00 = disable interrupt 01 = enable falling edge interrupt 10 = enable rising edge interrupt 11 = enable both falling or rising edge interrupt	R/W	00
31-30	PB15IM[1:0]	PortB.15 interrupt mode 00 = disable interrupt 01 = enable falling edge interrupt 10 = enable rising edge interrupt 11 = enable both falling or rising edge interrupt	R/W	00

**Port B Interrupt Status Register (PBISR)**

Bit	Bit Name	Description	R/W	InitVal
15-0	PBIP[15:0]	Interrupt pending status. Self clear after read.	R	00

## 12. 802.11b WLAN Controller

RTL8181 integrates with a wireless LAN MAC and a direct sequence spread spectrum baseband processor, and is full compliance with IEEE 802.11 and IEEE 802.11b specifications.

RTL8181 has on board A/D and D/A converters for analog I and Q inputs and outputs. Differential phase shift keying modulation schemes DBPSK and DQPSK, with data scrambling capability, are available along with complementary code keying to provide a variety of data rates. Both receive and transmit AGC functions obtain maximum performance in the analog portions of the transceiver. It also includes a built-in enhanced signal detector to alleviate severe multi-path effects. The target environment for 11Mbps is 125ns RMS delay spread. It also supports short preamble and antenna diversity. For security issues, RTL8181 has implemented a high performance internal WEP engine supporting up to 104-bits WEP.

The WLAN controller is a DMA bus-master device, and uses descriptor-based buffer structure for packet transmission and reception. These features will definitely offload much CPU loading.

RTL818 provides various interfaces for external RF module. Currently, it could interface with the RF modules as Intersil, RFMD and Philip.

**WLAN Controller register Set**

Virtual Address	Size (byte)	Name	Description	R/W
0xBD40_0000	8	WLAN_ID	ID Register : The ID register is only permitted to write by 4-byte access. Read access can be byte, word, or double word access.	R/W
0xBD40_0008	8	WLAN_MAR	Multicast Register: The MAR register is only permitted to write by 4-byte access. Read access can be byte, word, or double word access.	R/W
0xBD40_0018	8	WLAN_TSFTR	Timing Synchronization Function Timer Register	R
0xBD40_0020	4	WLAN_TLPDA	Transmit Low Priority Descriptors Start Address (32-bit). (256-byte alignment)	R/W
0xBD40_0024	4	WLAN_TNPDA	Transmit Normal Priority Descriptors Start Address (32-bit). (256-byte alignment)	R/W
0xBD40_0028	4	WLAN_THPDA	Transmit High Priority Descriptors Start Address (32-bit). (256-byte alignment)	R/W
0xBD40_002C	4	WLAN_BRSR	Basic Rate Set Register	R/W
0xBD40_002E	6	WLAN_BSSID	Basic Service Set ID	R/W
0xBD40_0037	1	WLAN_CR	Command Register	R/W
0xBD40_003C	2	WLAN_IMR	Interrupt Mask Register	R/W
0xBD40_003E	2	WLAN_ISR	Interrupt Status Register	R/W
0xBD40_0040	4	WLAN_TCR	Transmit (Tx) Configuration Register	R/W
0xBD40_0044	4	WLAN_RCR	Receive (Rx) Configuration Register	R/W
0xBD40_0048	4	WLAN_TINT	Timer Interrupt Register. Once having written a nonzero value to	R/W

[www.DataSheet4U.com](http://www.DataSheet4U.com)

			this register, the Timeout bit of WLAN_ISR register will be set whenever the least 32 bits of the WLAN_TSFTR reaches to this value. The Timeout bit will never be set as long as WLAN_TINT register is zero.	
0xBD40_004C	4	WLAN_TBDA	Transmit Beacon Descriptor Start Address (32-bit) (256-byte alignment)	R/W
0xBD40_0050	1	WLAN_CR	Command Register	R/W
0xBD40_0051	1	WLAN_CONFIG0	Configuration Register 0	R
0xBD40_0053	1	WLAN_CONFIG2	Configuration Register 2	R/W
0xBD40_0054	4	WLAN_ANAPARM	Analog parameter	R/W
0xBD40_0058	1	WLAN_MSR	Media Status Register	R/W
0xBD40_0059	1	WLAN_CONFIG3	Configuration Register 3	R/W
0xBD40_005A	1	WLAN_CONFIG4	Configuration Register 4	R/W
0xBD40_005B	1	WLAN_TESTR	TEST mode Register	R/W
0xBD40_005F	1	WLAN_SCR	Security Configuration Register	R/W
0xBD40_0070	2	WLAN_BCNTIV	Beacon Interval Register	R/W
0xBD40_0072	2	WLAN_ATIMWND	Atim Window Register	R/W
0xBD40_0074	2	WLAN_BINTRITV	Beacon interrupt Interval Register	R/W
0xBD40_0078	1	WLAN_PHYDELAY	Phy Delay Register	R/W
0xBD40_007A	2	WLAN_CRC16ERR	PLCP header CRC16 error count	R/W
0xBD40_007C	1	WLAN_PHYADDR	Address register for Phy interface	R/W
0xBD40_007D	1	WLAN_PHYDATAW	Write Data to Phy	W
0xBD40_007E	1	WLAN_PHYDATAR	Read Data from Phy	R
0xBD40_0080	4	WLAN_PHYCFG	Phy Configuration Register	R/W
0xBD40_0090	16	WLAN_DK0	WEP Default Key 0 Register	R/W
0xBD40_00A0	16	WLAN_DK1	WEP Default Key 1 Register	R/W
0xBD40_00B0	16	WLAN_DK2	WEP Default Key 2 Register	R/W
0xBD40_00C0	16	WLAN_DK3	WEP Default Key 3 Register	R/W
0xBD40_00D8	1	WLAN_CONFIG5	Configuration Register 5	R/W
0xBD40_00D9	1	WLAN_TPPOLL	Transmit Priority Polling Register	W
0xBD40_00DC	2	WLAN_CWR	Contention Window Register	R
0xBD40_00DE	1	WLAN_RETRYCTR	Retry Count Register	R
0xBD40_00E4	4	WLAN_RDSAR	Receive Descriptor Start Address Register (32-bit) (256-byte alignment)	R/W
0xBD40_0100	6	WLAN_KMAR	Key Map MAC Address	R/W
0xBD40_0106	15	WLAN_KMKEY	Key Map Key Value	R/W
0xBD40_0116	2	WLAN_KMC	Key Map Config	R/W

**TSF timer register (WLAN\_TSFTR)**

Bit	Bit Name	Description	R/W
63-0	TSFT	Timing Synchronization Function Timer: RTL8181 maintain a TSF timer with modules 2 <sup>64</sup> counting in increments of microseconds. The 8 octets are the timestamp field of beacon and probe response frame.	R

**Basic Rate Set Register (WLAN\_BRSR)**

Bit	Bit Name	Description
15-9	-	Reserved
8	BPLCP	0:Long PLCP header for CTS/ACK packet. 1:Short PLCP header for CTS/ACK packet.
7-4	-	Reserved
3-0	MBR	Maximum Basic Service Set Basic Rate. All control frames shall be transmitted at the rate that is less than or equal. bit0: 1M, bit1: 2M, bit2: 5.5M, bit3: 11M.

**Basic Service Set ID register (WLAN\_BSSID)**

Bit	Bit Name	Description	R/W
47-0	BSSID	Basic Service Set Identification: This register is written to by the driver after a NIC joins a network or creates an adhoc network.	R/W

**Command Register (WLAN\_CR)**

This register is used for issuing commands to WLAN controller. These commands are issued by setting the corresponding bits for the function. A global software reset along with individual reset and enable/disable for transmitter and receiver are provided here.

Bit	Bit Name	Description	R/W
7:5	-	Reserved	
4	RST	Reset: Setting this bit to 1 forces the RTL8181 do the WLAN MAC reset. During reset state, it will disable the transmitter and receiver, and reinitializes the FIFOs. The values of WLAN_IDR and WLAN_MAR7 will have no changes. This bit is 1 during the reset operation, and is cleared to 0 when the reset operation is complete.	R/W
3	RE	Receiver Enable: When set to 1, and the receive state machine is idle, the receive machine becomes active. This bit will read back as 1 whenever the receive state machine is active. After initial power-up, software must insure that the receiver has completely reset before setting this bit. 1: Enable 0: Disable	R/W
2	TE	Transmitter Enable: When set to 1, and the transmit state machine is idle, the transmit state machine becomes active. This bit will read back as 1 whenever the transmit state machine is active. After initial power-up, software must insure that the transmitter has completely reset before setting this bit. 1: Enable 0: Disable	R/W
1-0	-	Reserved	

**Interrupt Mask Register (WLAN\_IMR)**

This register masks the interrupts that can be generated from the Interrupt Status Register. A hardware reset will clear all mask bits. Setting a mask bit allows the corresponding bit in the Interrupt Status Register to cause an interrupt. The Interrupt Status Register bits are always set to 1 if the condition is present, regardless of the state of the corresponding mask bit.

Bit	Bit Name	Description	R/W
15	TXFOVW	Tx FIFO Overflow Interrupt: 1: Enable 0: Disable	R/W
14	TimeOut	Time Out Interrupt: 1: Enable 0: Disable	R/W
13	BcnInt	Beacon Time out Interrupt: 1: Enable 0: Disable	R/W
12	ATIMInt	ATIM Time Out Interrupt: 1: Enable 0: Disable	R/W
11	TBDER	Tx Beacon Descriptor Error Interrupt: 1: Enable 0: Disable	R/W
10	TBDOK	Tx Beacon Descriptor OK Interrupt: 1: Enable 0: Disable	R/W
9	THPDER	Tx High Priority Descriptor Error Interrupt: 1: Enable 0: Disable	R/W
8	THPDOK	Tx High Priority Descriptor OK Interrupt: 1: Enable 0: Disable	R/W
7	TNPDER	Tx Normal Priority Descriptor Error Interrupt: 1: Enable 0: Disable	R/W
6	TNPDOK	Tx Normal Priority Descriptor OK Interrupt: 1: Enable 0: Disable	R/W
5	RXFOVW	Rx FIFO Overflow Interrupt: 1: Enable 0: Disable	R/W
4	RDU	Rx Descriptor Unavailable Interrupt:	R/W



		1: Enable 0: Disable	
3	TLPDER	Tx Low Priority Descriptor Error Interrupt: 1: Enable 0: Disable	R/W
2	TLPDOK	Tx Low Priority Descriptor OK Interrupt: 1: Enable 0: Disable	R/W
1	RER	Rx Error Interrupt: 1: Enable 0: Disable	R/W
0	ROK	Rx OK Interrupt: 1: Enable 0: Disable	R/W

**Interrupt Status Register (WLAN\_ISR)**

This register indicates the source of WLAN controller interrupt goes active. Enabling the corresponding bits in the Interrupt Mask Register (WLAN\_IMR) allows bits in this register to produce an interrupt. When an interrupt is active, one or more bits in this register are set to a "1". The interrupt Status Register reflects all current pending interrupts, regardless of the state of the corresponding mask bit in the WLAN\_IMR. Reading the WLAN\_ISR clears all interrupts. Writing a 1 to any bit in this register will reset that bit.

Bit	Symbol	Description	R/W
15	TXFOVW	Tx FIFO Overflow	R/W
14	TimeOut	Time Out: This bit is set to 1 when the least 32 bits of the TSFTR register reaches to the value of the TimerInt register.	R/W
13	BcnInt	Beacon Time Out Interrupt: When set, this bit indicates that the TBTT (Target Beacon Transmission Time) has been reached after the value of the Beacon interrupt Interval register.	R/W
12	ATIMInt	ATIM Time Out Interrupt: When set, this bit indicates that the ATIM window has been gone after the value of the Beacon interrupt Interval register.	R/W
11	TBDER	Transmit Beacon Priority Descriptor Error: Indicates that a packet of beacon priority descriptor transmission was aborted due to an Rx beacon frame.	R/W
10	TBDOK	Transmit Beacon Priority Descriptor OK: Indicates that a packet of beacon priority descriptor exchange sequence has been successfully completed.	R/W
9	THPDER	Transmit High Priority Descriptor Error: Indicates that a packet of high priority descriptor transmission was aborted due to an SSRC (Station Short Retry Count) has reached SRL (Short Retry Limit), and an SLRC (Station Long Retry Count) has reached LRL (Long Retry Limit).	R/W
8	THPDOK	Transmit High Priority Descriptor OK: Indicates that a packet of high priority descriptor exchange sequence has been successfully completed.	R/W
7	TNPDER	Transmit Normal Priority Descriptor Error: Indicates that a packet of normal priority descriptor transmission was aborted due to an SSRC (Station Short Retry Count) has reached SRL (Short Retry Limit), and an SLRC (Station Long Retry Count) has reached LRL (Long Retry Limit).	R/W
6	TNPDOK	Transmit Normal Priority Descriptor OK: Indicates that a packet of normal priority descriptor exchange sequence has been successfully completed.	R/W
5	FOVW	Rx FIFO Overflow: This bit set to 1 is caused by RDU, poor PCI performance, or overloaded PCI traffic.	R/W
4	_RDU	Rx Descriptor Unavailable: When set, this bit indicates that the Rx descriptor is currently unavailable.	R/W
3	TLPDER	Transmit Low Priority Descriptor Error: Indicates that a packet of low priority descriptor transmission was aborted due to an SSRC (Station Short Retry Count) has reached SRL (Short Retry Limit), and an SLRC (Station Long Retry Count) has reached LRL (Long Retry Limit).	R/W
2	TLPDOK	Transmit Low Priority Descriptor OK: Indicates that a packet of low priority descriptor exchange sequence has been successfully completed.	R/W
1	RER	Receive Error: Indicates that a packet has a CRC32 or ICV error.	R/W
0	ROK	Receive OK: In normal mode, indicates the successful completion of a packet reception.	R/W



[www.DataSheet4U.com](http://www.DataSheet4U.com)
**Transmit Configuration Register (WLAN\_TCR)**

This register defines the Transmit Configuration for the WLAN controller. It controls such functions as loopback, heartbeat, auto transmit padding, programmable inter-frame gap, fill and drain thresholds, and maximum DMA burst size.

Bit	Symbol	Description	R/W
31	CWMIN	Contention Window minimum value: Set to 1 to indicate that Cwmin=8. Set to 0 to indicate that Cwmin=32.	R/W
30	SEQGEN	Sequence number generation switch. 0 – Enabled. Sequence number is generated by RTL8181. 1 – Disabled. Sequence number should be filled by software.	
29-25	-	Reserved	
24	SAT	Set ACK Timeout: The EIFS, ACK and CTS timeouts are derived from the following equation: $EIFS = 112/ACKrate + 252$ 1: ACKrate is dependent on the maximum of MBR (bits 1:0, BRSR) and Rx DATA/RTS rate. 0: ACKrate is fixed at 1Mbps.	R/W
23-21	MXDMA2, 1, 0	Max DMA Burst Size per Tx DMA Burst: This field sets the maximum size of transmit DMA data bursts according to the following table: 000: 16 bytes 001: 32 bytes 010: 64 bytes 011: 128 bytes 100: 256 bytes 101: 512 bytes 110: 1024 bytes 111: 2048 bytes	R/W
20	DISCW	Disable Contention Window Backoff: This bit indicates the existence of a backoff procedure during packet transmission. 1: No random backoff procedure 0: Uses IEEE 802.11 random backoff procedure	R/W
19	ICV	Append ICV: This bit indicates the existence of ICV appended at the end of an encipherment packet. 1: No ICV appended 0: ICV appended	R/W
18-17	LBK1, LBK0	Loopback Test: There will be no packet on the TXI+/- and TXQ+/- lines under the Loopback test condition. The loopback function must be independent of the link state. 00: Normal operation 01: MAC Loopback 10: Baseband Loopback 11: Continue TX.	R/W
16	CRC	Append CRC32: This bit indicates the existence of a CRC32 appended at the end of a packet. 1: No CRC32 appended 0: A CRC32 is appended	R/W
15-8	SRL	RTS Retry Limit: Indicates the maximum retry times of RTS frame, data or management frame of length less than or equal to RTSThreshold.	R/W
7-0	LRL	Data Packet Retry Limit: Indicates the maximum retransmission times of Data or Management frame of length greater than RTSThreshold.	R/W

**Receive Configuration Register(WLAN\_RCR)**

This register is used to set the receive configuration for the WLAN controller. Receive properties such as accepting error packets, runt packets, setting the receive drain threshold etc. are controlled here.

Bit	Bit Name	Description	R/W
31	ONLYERLPKT	Early Receiving based on Packet Size: Early Receiving is only performed for packets with a size greater than 1536 bytes.	R/W
30	ENCS2	Enable Carrier Sense Detection Method 2	R/W

29	ENCS1	Enable Carrier Sense Detection Method 1	R/W
28	ENMARP	Enable MAC Autoreset PHY	R/W
27-24	-	Reserved	R/W
23	CBSSID	Check BSSID, To DS, From DS Match Packet: When set to 1, the RTL8181 will check the Rx data type frame's BSSID, To DS and From DS fields, according to NETYPE (bits 3:2, MSR), to determine if it is set to Link ok at an Infrastructure or Adhoc network.	R/W
22	APWRMGT	Accept Power Management Packet: This bit will determine whether the RTL8181 will accept or reject packets with the power management bit set. 1: Accept 0: Reject	R/W
21	ADD3	Accept Address 3 Match Packets: Set this bit to 1 to accept broadcast/multicast data type frames that Address 3 matching RTL8181's MAC address. This bit is valid only when NETYPE (bits 3:2, MSR) is set to Link ok in an Infrastructure network.	R/W
20	AMF	Accept Management Frame: This bit will determine whether the RTL8181 will accept or reject a management frame. 1: Accept 0: Reject	R/W
19	ACF	Accept Control Frame: This bit will determine whether the RTL8181 will accept or reject a control frame. 1: Accept 0: Reject	R/W
18	ADF	Accept Data Frame: This bit will determine whether the RTL8181 will accept or reject a data frame. 1: Accept 0: Reject	R/W
17-16	-	Reserved	
15-13	RXFTH2, 1, 0	Rx FIFO Threshold: This bit specifies the Rx FIFO Threshold level. When the number of the received data bytes from a packet, which is being received into the Rx FIFO of the RTL8181, has reached to this level (or the FIFO has contained a complete packet), the receive PCI bus master function will begin to transfer the data from the FIFO to the host memory. This field sets the threshold level according to the following table: 000: Reserved 001: Reserved 010: 64 bytes 011: 128 bytes 100: 256 bytes 101: 512 bytes 110: 1024 bytes 111: No Rx threshold. The RTL8181 begins the transfer of data after having received a whole packet into the FIFO.	
12	AICV	Accept ICV Error Packet: This bit determines whether all packets with ICV error will be accepted or rejected. 1: Accept 0: Reject	
11	-	Reserved	
10-8	MXDMA2, 1, 0	Max DMA Burst Size per Rx DMA Burst: This field sets the maximum size of the receive DMA data bursts according to the following table: 000: 16 bytes 001: 32 bytes 010: 64 bytes 011: 128 bytes 100: 256 bytes 101: 512 bytes 110: 1024 bytes 111: Unlimited	
7-6	-	Reserved	
5	ACRC32	Accept CRC32 Error Packet: When set to 1, all packets with CRC32 error will be accepted. When set to 0, all packets with CRC32 error will be rejected. 1: Accept	

4	-	0: Reject Reserved	
3	AB	Accept Broadcast Packets: This bit determines whether broadcast packets will be accepted or rejected. 1: Accept 0: Reject	
2	AM	Accept Multicast Packets: This bit determines whether multicast packets will be accepted or rejected. 1: Accept 0: Reject	
1	APM	Accept Physical Match Packets: This bit determines whether physical match packets will be accepted or rejected. 1: Accept 0: Reject	
0	AAP	Accept Destination Address Packets: This bit determines whether all packets with a destination address will be accepted or rejected. 1: Accept 0: Reject	

**Command Register (WLAN\_CR)**

This register is used for issuing commands to the WLAN controller. These commands are issued by setting the corresponding bits for the function. A warm software reset along with individual reset and enable/disable for transmitter and receiver are provided as well.

Bit	Bit Name	Description	R/W
7-6	EEM	These 2 bits select the operating mode. 00: Operating in network/host communication mode. 11: Before writing to the WLAN_CONFIG0, 1, 2, and 3 registers, the RTL8181 must be placed in this mode. This will prevent accidental change of the configurations of the WLAN controller.	R/W
5-0	-	Reserved	

**Configuration Register 0 (WLAN\_CONFIG0)**

Bit	Bit Name	Description	R/W
7-4	-	Reserved	
3	Aux_Status	Auxiliary Power Present Status: This bit indicates the existence of Aux. power. The value of this bit is fixed after each reset. 1: Aux. Power is present 0: Aux. Power is absent	R/W
2	-	Reserved	
1-0	GL	Geographic Location: These bits indicate the current operational region in which RTL8181 transmits and receives packets.. USA: 11, Europe: 10, Japan: 0	R/W

**Configuration Register 2 (WLAN\_CONFIG2)**

Bit	Bit Name	Description	R/W
7	LCK	Locked Clocks: Set this bit to 1 to indicate that the transmit frequency and symbol clocks are derived from the same oscillator.	R/W
6	ANT	Antenna Diversity: 1: Enable 0: Disable	R/W
5-4	-	Reserved	-
3	DPS	Descriptor Polling State: Test mode.. 0: Normal working state. This is also the power-on default value. 1: Test Mode	R/W
2	PAPE_sign	1: RTL8181 will advance PAPE_time to enable the PAPE pin when Tx data 0: RTL8181 will delay PAPE_time to enable the PAPE pin when Tx data	R/W
1-0	PAPE_time	These two bits indicate that the RTL8181 has enabled the PAPE pin in $\mu$ s.	R/W

[www.DataSheet4U.com](http://www.DataSheet4U.com)
**Media Status Register (WLAN\_MSR)**

This register allows configuration of device and PHY options, and provides PHY status information.

Bit	Bit Name	Description	R/W
7-4	-	Reserved	-
3-2	NETTYPE	Network Type and Link Status: The values of these bits are written by the driver. 10: Infrastructure client, 01: Ad hoc, 11: Access Point, 00: No link	R/W
1-0	-	Reserved	-

**Configuration Register 3 (WLAN\_CONFIG3)**

Bit	Bit Name	Description	R/W
7	-	Reserved	-
6	PARAM_En	Parameter Write Enable: Setting this bit to 1 and the WLAN_CR register EEM1=EEM0=1 enables the WLAN_ANAPARM register to be written via software.	R/W
4-1	--	Reserved	-
0	FBtBEn	Fast Back to Back Enable: 1: Enable 0: Disable	R/W

**Configuration Register 4 (WLAN\_CONFIG4)**

Bit	Bit Name	Description	R/W
7	VCOPDN	VCO Power Down: 1: VCO Power Down mode. Setting this bit will enable VCOPDN pin and turn off the external RF front end power (including VCO) and most of the internal power of the RTL8181. 0: Normal working state. This is the power-on default value.	R/W
6	PWROFF	Power Off: 1: Power Off mode. Turn off the external RF front end power (excluding VCO) and most of the internal power of the RTL8181. 0: Normal working state. This is the power-on default value.	R/W
5	PWRMGT	Power Management: 1: Power Management mode. Set Tx packet's power management bit to 1 include control type frame. 0: Normal working state. This is the power-on default value.	R/W
4-2	-	Reserved	-
1-0	RFTYPE	Radio Front End Programming Method: The combination of these two bits indicate what kind of the RF module is being used with the RTL8181. 11: Philips, 10: RFMD, 01: Intersil	R/W

**Security Configuration Register (WLAN\_SCR)**

Bit	Bit Name	Description	R/W
7-6	-	Reserved	-
5-4	KM	Key Mode: The combination of these two bits indicate what kind of security scheme is being used. 01: WEP40, 01: WEP104	R/W
3-2	-	Reserved	-
1	TXSECON	TX Security ON: Set this bit to 1 to turn on the option security scheme of the Tx path. This bit is written by software and is invalid when WEP40 (bit 7, WLAN_CONFIG0), and WEP104 (bit 6, WLAN_CONFIG0) are set to 0.	R/W
0	RXSECON	RX Security ON: Set this bit to 1 to turn on the option security scheme of the Rx path. This bit is written by software and is invalid when WEP40 (bit 7, WLAN_CONFIG0), and WEP104 (bit 6, WLAN_CONFIG0) are set to 0.	R/W

[www.DataSheet4U.com](http://www.DataSheet4U.com)
**Beacon Interval Register (WLAN\_BCNTV)**

Bit	Bit Name	Description	R/W
15-10	-	Reserved	-
9-0	BcnItv	Beacon Interval: The Beacon Interval represents the number of time units (1 TU = R/W 1024 $\mu$ s) between target beacon transmission times (TBTTs). This register is written by the driver after starting a BSS/IBSS or joining IBSS network.	R/W

**ATIM Window Register (WLAN\_ATIMWND)**

Bit	Bit Name	Description	R/W
15-10	--	Reserved	-
9-0	AtimWnd	This register indicates the ATIM Window length in TU. It is written by the driver after the NIC joins or creates an adhoc network.	R/W

**Beacon Interrupt Interval Register (WLAN\_BINTRITV)**

Bit	Bit Name	Description	R/W
15-10	-	Reserved	-
9-0	BintrItv	This timer register will generate BcnInt (bit 13, ISR) at a setting time interval before TBTT to prompt the host to prepare the beacon. The units of this register is microseconds. It is written by the driver after the NIC joins a network or creates an adhoc network.	R/W

**Atim Interrupt Interval Register (WLAN\_ATIMTRITV)**

Bit	Bit Name	Description	R/W
15-10	-	Reserved	-
9-0	AtimtrItv	This timer register will generate ATIMInt (bit 12, ISR) at a setting time interval before the end of the ATIM window in an adhoc network. The units of this register is microseconds. It is written by the driver after the NIC joins a network or creates an adhoc network.	R/W

**Phy Delay Register (WLAN\_PHYDELAY)**

Bit	Bit Name	Description	R/W
7-3	-	Reserved	-
2-0	PhyDelay	Physical Layer Delay Time: These three bits represent the delay time in $\mu$ s between the MAC and RF front end when Tx data.	R/W

**Default Key 0 Register (WLAN\_DK0)**

Bit	Bit Name	Description	R/W
127-104	-	Reserved	-
103-0	DK0	Default Key 0: These 104 bits (bits 103:0) indicate the default 104-bit WEP key, which the ID is 0 when KM (bits 5:4, SCR) is set to WEP104, the 24 most significant bits (bits 127:103) will be reserved. The 40 least significant bits (bits 39:0) indicate the default 40-bit WEP key, which the ID is 0 when KM is set to WEP40, and the 64 most significant bits (bits 103:40) will be reserved. This register is only permitted to read/write by 4-byte access.	R/W

**Default Key 1 Register (WLAN\_DK1)**

Bit	Bit Name	Description	R/W
127-104	-	Reserved	-
103-0	DK1	Default Key 1: These 104 bits (bits 103:0) indicate the default 104-bit WEP key, which the ID is 1 when KM (bits 5:4, SCR) is set to WEP104, the 24 most significant bits (bits 127:103) will be reserved. The 40 least significant bits (bits 39:0) indicate the default 40-bit WEP key, which the ID is 1 when KM is set to WEP40, and the 64 most significant bits (bits 103:40) will be reserved. This register is only permitted to read/write by 4-byte access.	R/W

**Default Key 2 Register (WLAN\_DK2)**

Bit	Bit Name	Description	R/W
127:104	-	Reserved	-
103:0	DK2	Default Key 2: These 104 bits (bits 103:0) indicate the default 104-bit WEP key, which the	R/W

[www.DataSheet4U.com](http://www.DataSheet4U.com)

		ID is 2 when KM (bits 5:4, SCR) is set to WEP104, the 24 most significant bits (bits 127:103) will be reserved. The 40 least significant bits (bits 39:0) indicate the default 40-bit WEP key, which the ID is 2 when KM is set to WEP40, and the 64 most significant bits (bits 103:40) will be reserved. This register is only permitted to read/write by 4-byte access.
--	--	--

**Default Key 3 Register (WLAN\_DK3)**

Bit	Bit Name	Description	R/W
127-104	-	Reserved	-
103-0	DK3	Default Key 3: These 104 bits (bits 103:0) indicate the default 104-bit WEP key, which the ID is 3 when KM (bits 5:4, SCR) is set to WEP104, the 24 most significant bits (bits 127:103) will be reserved. The 40 least significant bits (bits 39:0) indicate the default 40-bit WEP key, which the ID is 3 when KM is set to WEP40, and the 64 most significant bits (bits 103:40) will be reserved. This register is only permitted to read/write by 4-byte access.	R/W

**Configuration Register 5 (WLAN\_CONFIG5)**

This register, unlike other Configuration registers, is not protected by the Command register. Therefore, there is no need to enable the Config register write prior to writing to Config5.

Bit	Bit Name	Description	R/W
7	TX_FIFO_OK	Built in Self Test for TX FIFO: 1: OK 0: Fail	R
6	RX_FIFO_OK	Built in Self Test for RX FIFO: 1: OK 0: Fail	R
5	CALON	Calibration ON. 1: Activate the calibration cycle, and hold AGCRESET pin to high 0: Put AGCRESET pin to ground	R/W
4-0	-	Reserved	-

**Transmit Priority Polling Register (WLAN\_TPPOLL)**

Bit	Bit Name	Description	R/W
7	BQ	Beacon Queue Polling: The RTL8181 will clear this bit automatically after a beacon packet has been transmitted or received. Writing to this bit has no effect.	W
6	HPQ	High Priority Queue Polling: Write a 1 to this bit by software to notify the RTL8181 that there is a high priority packet(s) waiting to be transmitted. The RTL8181 will clear this bit automatically after all high priority packets have been transmitted. Writing a 0 to this bit has no effect.	W
5	NPQ	Normal Priority Queue Polling: DPS (bit3, Config 2) set to 0: The RTL8181 will clear this bit automatically after all normal priority packets have been transmitted or received. Writing to this bit has no effect. DPS (bit3, Config 2) set to 1: Write a 1 to this bit by software to notify the RTL8181 that there is a normal priority packet(s) waiting to be transmitted. The RTL8181 will clear this bit automatically after all normal priority packets have been transmitted. Writing a 0 to this bit has no effect.	W
4	LPQ	Low Priority Queue Polling: Write a 1 to this bit by software to notify the RTL8181 that there is a low priority packet(s) waiting to be transmitted. The RTL8181 will clear this bit automatically after all low priority packets have been transmitted. Writing a 0 to this bit has no effect.	W

3	SBQJ.com	Stop Beacon Queue: Write a 1 to this bit by software to notify the RTL8181 to stop the DMA mechanism of the Beacon Queue. This bit is invalid when DPS (bit3, Config 2) is set to 1.	W
2	SHPQ	Stop High Priority Queue: Write a 1 to this bit by software to notify the RTL8181 to stop the DMA mechanism of the High Priority Queue.	W
1	SNPQ	Stop Normal Priority Queue: Write a 1 to this bit by software to notify the RTL8181 to stop the DMA mechanism of the Normal Priority Queue. This bit is invalid when DPS (bit3, Config 2) is set to 1.	W
0	SLPQ	Stop Low Priority Queue: Write a 1 to this bit by software to notify the RTL8181 to stop the DMA mechanism of the Low Priority Queue.	W

**Contention Window Register (WLAN\_CWR)**

Bit	Bit Name	Description	R/W
15-10	-	Reserved	-
9-0	CW	Contention Window: This register indicates the number of contention windows before transmitting a packet.	R

**Retry Count Register (WLAN\_RETRYCTR)**

Bit	Bit Name	Description	R/W
7-0	RetryCT	Retry Count: This register indicates the number of retry counts when a packet transmit is completed.	R

**Receive Descriptor Start Address Register (WLAN\_RDSAR)**

Bit	Bit Name	Description	R/W
31-0	RDSA	Receive Descriptor Start Address: This is a 32-bit address.	R/W

**WEP Key mapping**

The WEP key table will contain 64 entries that include the key to be used to encrypt the transmit packets and decrypted the received frame. Each entry contains the MAC address, associated key value, key type (may be 40bits or 104 bits) and a key-valid flag.

To set/get an entry to/from the table, you can't access the table memory directly. Instead, the access should go through registers because the key table is embedded in ASIC. When reading/writing the entry, you have to specify which table entry you are going to access by an index value defined in register **KeyMapIdx**.

For example, if you wants to update a table entry, you need set MAC address in **keyMapAddr**, set key value in **KeyMapKey**, specify key type (40bits or 104bits) in **KeyMapType**, set table index in **keyMapIdx**, assert the valid flag in **KeyMapValid**, and write '1' in **KeyMapOp** as 'write' operation. After all these values are set, you have to set '1' in register **KeyMapPoll** bit to tell WLAN controller to process the request. Then, you may wait the WLAN controller to accomplish the operation by polling **KeyMapPoll** bit until it is cleared.

There is no default value for these registers in initialization. Therefore, you have to reset the **KeyMapValid** flag for those entries you did not used.

**Key Map MAC Address (WLAN\_KMAR)**

Bit	Bit Name	Description	R/W
47-0	KeyMapAddr	MAC address	R/W

**Key Map Key Value (WLAN\_KMKEY)**

Bit	Bit Name	Description	R/W
127-0	KeyMapKey	WEP key value	R/W

**Key Map Config (WLAN\_KMC)**

Bit	Bit Name	Description	R/W
15-10	KeyMapIdx	Key map index, specify which table entry to read or write.	R/W
9-8	KeyMapType	Key value type. 0 – 40bits, 1-104bits, 2-3 reserved.	R/W
7	KeyMapValid	Valid flag. If this bit is '1', it indicates the table entry, indexed by <i>KeyMapIdx</i> , is valid. Bit	R/W



www.DataSheet4U.com		'0' implies the entry is invalid.	
6	KeyMapOp	Operation for writing or reading key value. Value '1' indicates to set key value, '0' means to get key value.	R/W
5	KeyMapPoll	Polling bit of read/write key. 1. Set '1' to make RTL8181 begin to read/write the value of key table, which entry index is specified in <i>KeyMapIdx</i> . 2. RTL8181 will clear the bit atomically after the operation is completed. 3. Writing '0' to this bit has no effect.	R/W
4-0	-	Reserved	-

### Packet Buffering

RTL8181 WLAN controller incorporates two independent FIFOs for transferring data to/from the system interface and from/to the network. The FIFOs, providing temporary storage of data freeing the host system from the real-time demands of the network.

The way in which the FIFOs are emptied and filled is controlled by the FIFO threshold values in the Receive Configuration registers. These values determine how full or empty the FIFOs must be before the device requests the bus. Once RTL8181 requests the bus, it will attempt to empty or fill the FIFOs as allowed by the respective MXDMA settings in the Transmit Configuration and Receive Configuration registers.

### Transmit Buffer Manager

The buffer management scheme used on the WLAN controller allows quick, simple and efficient use of the frame buffer memory. The buffer management scheme uses separate buffers and descriptors for packet information. This allows effective transfers of data to the transmit buffer manager by simply transferring the descriptor information to the transmit queue. The Tx Buffer Manager DMAs packet data from system memory and places it in the 4KB transmit FIFO, and pulls data from the FIFO to send to the Tx MAC. Multiple packets may be present in the FIFO, allowing packets to be transmitted with short interframe space. Additionally, once RTL8181 requests the bus, it will attempt to fill the FIFO as allowed by the MXDMA setting.

The Tx Buffer Manager process also supports priority queuing of transmit packets. It handles this by drawing from two separate descriptor lists to fill the internal FIFO. If packets are available in the high priority queues, they will be loaded into the FIFO before those of low priority.

### Receive Buffer Manager

The Rx Buffer Manager uses the same buffer management scheme as used for transmits. The Rx Buffer Manager retrieves packet data from the Rx MAC and places it in the 2KB receive data FIFO, and pulls data from the FIFO for DMA to system memory. The receive FIFO is controlled by the FIFO threshold value in RXFTH. This value determines the number of long words written into the FIFO from the MAC unit before a DMA request for system memory occurs. Once the RTL8181 gets the bus, it will continue to transfer the long words from the FIFO until the data in the FIFO is less than one long word, or has reached the end of the packet, or the max DMA burst size is reached, as set in MXDMA.

## 13. Package Information

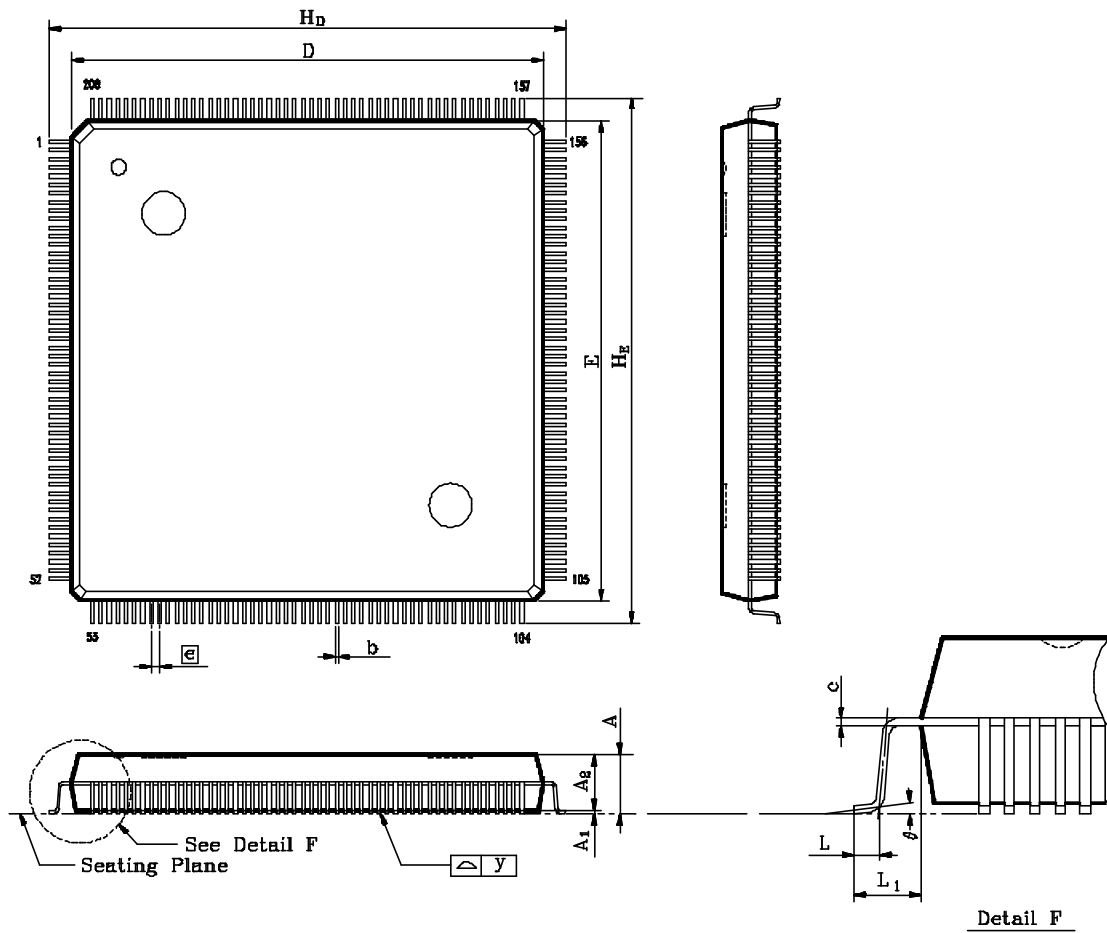

**Package outline for 208 LQFP(28\*28\*1.4mm)**

**Note:**

- 1.Dimension D & E do not include interlead flash.
- 2.Dimension b does not include dambar protrusion/intrusion.
- 3.Controlling dimension: Millimeter
- 4.General appearance spec. should be based on final visual inspection spec.

Symbol	Dimension in inch			Dimension in mm		
	Min	Typ	Max	Min	Typ	Max
A	0.136	0.144	0.152	3.45	<b>3.65</b>	3.85
A1	0.004	0.010	0.036	0.10	<b>0.25</b>	0.91
A2	0.119	0.128	0.136	3.02	<b>3.24</b>	3.46
b	0.004	0.008	0.012	0.10	<b>0.20</b>	0.30
c	0.002	0.006	0.010	0.04	<b>0.15</b>	0.26
D	1.093	1.102	1.112	27.75	<b>28.00</b>	28.25
E	1.093	1.102	1.112	27.75	<b>28.00</b>	28.25
e	0.012	0.020	0.031	0.30	<b>0.50</b>	0.80
HD	1.169	1.205	1.240	29.70	<b>30.60</b>	31.50
HE	1.169	1.205	1.240	29.70	<b>30.60</b>	31.50
L	0.010	0.020	0.030	0.25	<b>0.50</b>	0.75
L1	0.041	0.051	0.061	1.05	<b>1.30</b>	1.55
y	-	-	0.004	-	-	0.10
?	0°	-	12°	0°	-	12°

TITLE : 208L QFP ( 28x28 mm**2 ) FOOTPRINT 2.6mm			
PACKAGE OUTLINE DRAWING			
LEADFRAME MATERIAL:			
APPROVE	DOC. NO.	530ASS-P004	
	VERSION	1	
	PAGE	22 OF 22	
CHECK	DWG NO.	Q208 - 1	
	DATE	APR. 11.1997	
REALTEK SEMI-CONDUCTOR CO.,LTD			

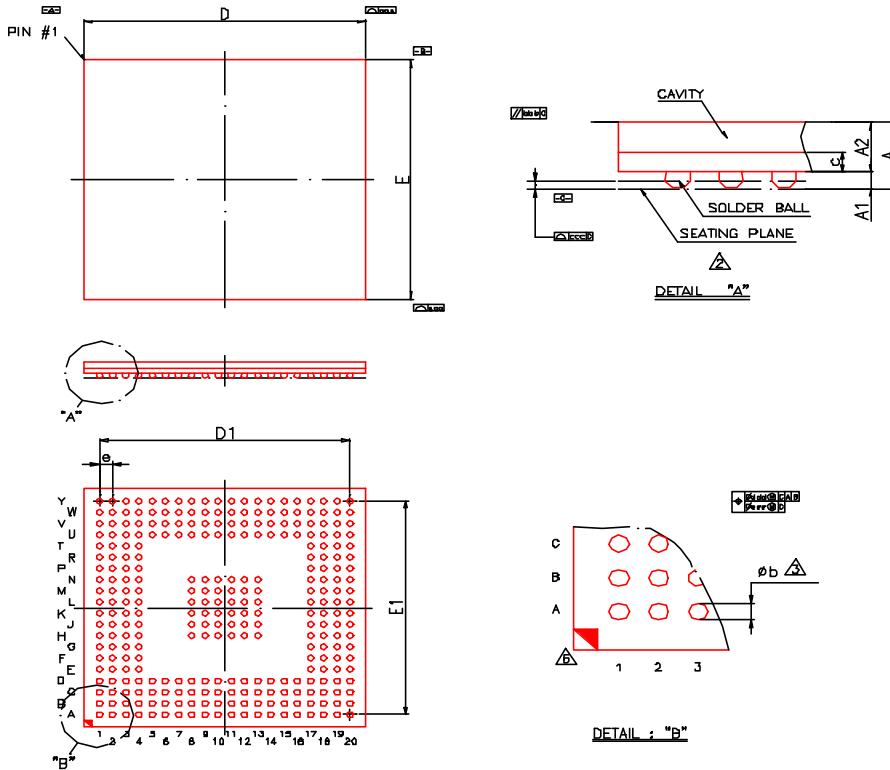
Package outline for TFBGA 292 BALL(17\*17 mm)



1. CONTROLLING DIMENSION : MILLIMETER
2. PRIMARY DATUM C AND SEATING PLANE ARE DEFINED BY THE SPHERICAL CROWNS OF THE SOLDER BALLS.
3. DIMENSION b IS MEASURED AT THE MAXIMUM SOLDER BALL DIAMETER, PARALLEL TO PRIMARY DATUM C.
4. THERE SHALL BE A MINIMUM CLEARANCE OF 0.25mm BETWEEN THE EDGE OF THE SOLDER BALL AND THE BODY EDGE.
5. REFERENCE DOCUMENT : JEDEC MO-205.
6. THE PATTERN OF PIN 1 FIDUCIAL IS FOR REFERENCE ONLY.

Symbol	Dimension in mm			Dimension in inch		
	Min	Nom	Max	Min	Nom	Max
A	---	---	1.30	---	---	0.051
A1	0.25	0.30	0.35	0.010	0.012	0.014
A2	0.84	0.89	0.94	0.033	0.035	0.037
c	0.32	0.36	0.40	0.013	0.014	0.016
D	16.90	17.00	17.10	0.665	0.669	0.673
E	16.90	17.00	17.10	0.665	0.669	0.673
D1	---	15.20	---	---	0.598	---
E1	---	15.20	---	---	0.598	---
e	---	0.80	---	---	0.031	---
b	0.35	0.40	0.45	0.014	0.016	0.018
aaa	0.10			0.004		
bbb	0.10			0.004		
ccc	0.12			0.005		
ddd	0.15			0.006		
eee	0.08			0.003		
MD/ME	20/20			20/20		

TITLE : 292LD TFBGA ( 17x17mm) PACKAGE OUTLINE			
SUBSTRATE MATERIAL: BT RESIN			
APPR.		DWG NO..	
ENG.		Rev NO	
QM.		PRODUCT CODE	
CHK.		DATE.	
DWG.		SHT No.	
REALTEK SEMI-CONDUCTOR CO., LTD			