

Features

- Low-voltage differential signal (LVDS) input with on-chip 100- Ω input termination resistor
- Ten differential LVDS outputs
- 40-ps maximum output-to-output skew
- 600-ps maximum propagation delay
- 0.11-ps maximum additive RMS phase jitter at 156.25 MHz (12-kHz to 20-MHz offset)
- Up to 1.5-GHz operation
- Synchronous clock enable function
- 32-pin thin quad flat pack (TQFP) package
- 2.5-V or 3.3-V operating voltage^[1]
- Commercial and industrial operating temperature range

Functional Description

The CY2DL1510 is an ultra-low noise, low-skew, low-propagation delay 1:10 differential LVDS fanout buffer targeted to meet the requirements of high-speed clock distribution applications. The on-chip 100- Ω input termination resistor reduces board component count, while the synchronous clock enable function ensures glitch-free output transitions during enable and disable periods. The device has a fully differential internal architecture that is optimized to achieve low-additive jitter and low-skew at operating frequencies of up to 1.5 GHz.

Logic Block Diagram

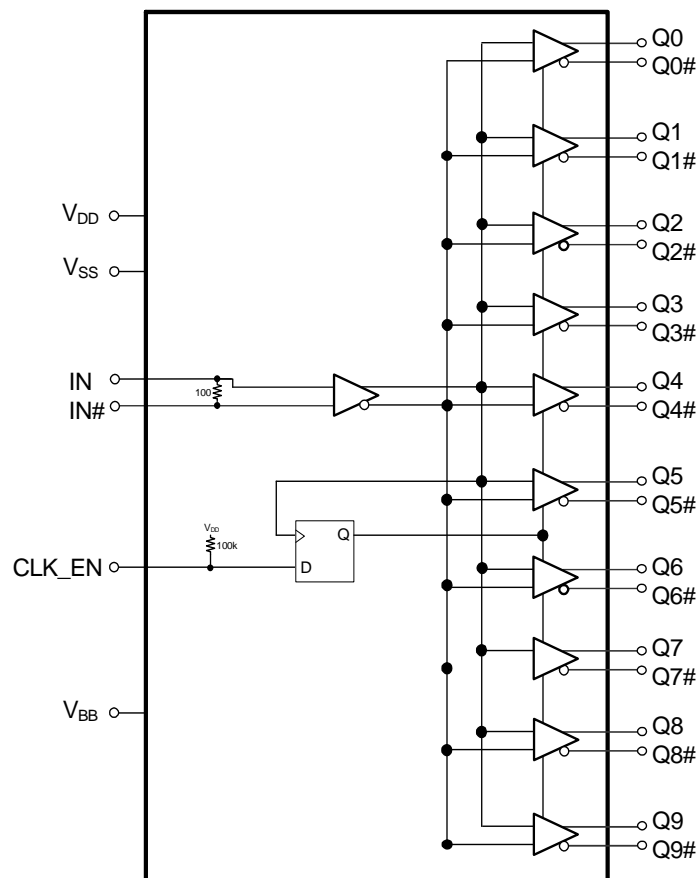

Note

1. Input AC-coupling capacitors are required for voltage-translation applications.

Contents

Pinouts	3	Acronyms	12
Absolute Maximum Ratings	4	Document Conventions	12
Operating Conditions	4	Document History Page	13
DC Electrical Specifications	5	Sales, Solutions, and Legal Information	15
AC Electrical Specifications	6	Worldwide Sales and Design Support	15
Ordering Information	10	Products	15
Ordering Code Definition	10	PSoC Solutions	15
Package Dimension	11		

Pinouts

Figure 1. Pin Diagram - CY2DL1510

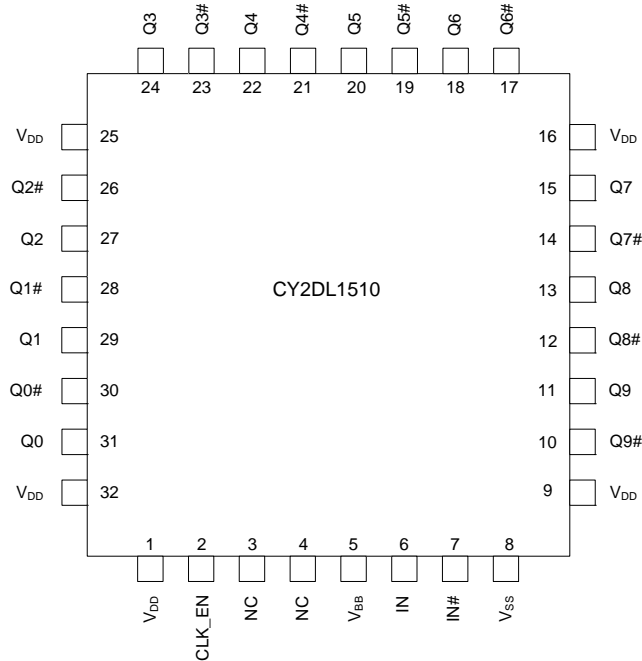

Table 1. Pin Definitions

Pin No.	Pin Name	Pin Type	Description
1, 9, 16, 25, 32	V _{DD}	Power	Power supply
2	CLK_EN	Input	Synchronous clock enable. Low-voltage complementary metal oxide semiconductor (LVCMOS)/low-voltage transistor-transistor-logic (LVTTTL). When CLK_EN = Low, Q(0:9) outputs are held low and Q(0:9)# outputs are held high
3, 4	NC		No connection
5	V _{BB}	Output	LVDS reference voltage output
6	IN	Input	LVDS input clock
7	IN#	Input	LVDS complementary input clock
8	V _{SS}	Power	Ground
10,12,14,17,19,21, 23,26,28,30	Q(0:9)#	Output	LVDS complementary output clocks
11,13,15,18,20,22, 24,27,29,31	Q(0:9)	Output	LVDS output clocks

Absolute Maximum Ratings

Parameter	Description	Condition	Min	Max	Unit
V _{DD}	Supply voltage	Nonfunctional	-0.5	4.6	V
V _{IN} ^[2]	Input voltage, relative to V _{SS}	Nonfunctional	-0.5	lesser of 4.0 or V _{DD} + 0.4	V
V _{OUT} ^[2]	DC output or I/O Voltage, relative to V _{SS}	Nonfunctional	-0.5	lesser of 4.0 or V _{DD} + 0.4	V
T _S	Storage temperature	Nonfunctional	-55	150	°C
ESD _{HBM}	Electrostatic discharge (ESD) protection (Human body model)	JEDEC STD 22-A114-B	2000	-	V
L _U	Latch up		Meets or exceeds JEDEC Spec JESD78B IC latch up test		
UL-94	Flammability rating	At 1/8 in.	V-0		
MSL	Moisture sensitivity level		3		

Operating Conditions

Parameter	Description	Condition	Min	Max	Unit
V _{DD}	Supply voltage	2.5-V supply	2.375	2.625	V
		3.3-V supply	3.135	3.465	V
T _A	Ambient operating temperature	Commercial	0	70	°C
		Industrial	-40	85	°C
t _{PU}	Power ramp time	Power-up time for V _{DD} to reach minimum specified voltage (power ramp must be monotonic.)	0.05	500	ms

Note

2. The voltage on any I/O pin cannot exceed the power pin during power-up. Power supply sequencing is not required.

DC Electrical Specifications

($V_{DD} = 3.3\text{ V} \pm 5\%$ or $2.5\text{ V} \pm 5\%$; $T_A = 0\text{ }^\circ\text{C}$ to $70\text{ }^\circ\text{C}$ (Commercial) or $-40\text{ }^\circ\text{C}$ to $85\text{ }^\circ\text{C}$ (Industrial))

Parameter	Description	Condition	Min	Max	Unit
I_{DD}	Operating supply current	All LVDS outputs terminated with $100\ \Omega$ load ^[3, 4]	–	125	mA
V_{IH1}	Input high Voltage, LVDS input clocks, IN and IN#		–	$V_{DD} + 0.3$	V
V_{IL1}	Input low voltage, LVDS input clocks, IN and IN#		–0.3	–	V
V_{IH2}	Input high voltage, CLK_EN	$V_{DD} = 3.3\text{ V}$	2.0	$V_{DD} + 0.3$	V
V_{IL2}	Input low voltage, CLK_EN	$V_{DD} = 3.3\text{ V}$	–0.3	0.8	V
V_{IH3}	Input high voltage, CLK_EN	$V_{DD} = 2.5\text{ V}$	1.7	$V_{DD} + 0.3$	V
V_{IL3}	Input low voltage, CLK_EN	$V_{DD} = 2.5\text{ V}$	–0.3	0.7	V
V_{ID} ^[5]	Input differential amplitude	See Figure 3 on page 7	0.4	0.8	V
V_{ICM}	Input common mode voltage	See Figure 3 on page 7	0.5	$V_{DD} - 0.2$	V
I_{IH}	Input high current, All inputs	Input = V_{DD} ^[6]	–	150	μA
I_{IL}	Input low current, All inputs	Input = V_{SS} ^[6]	–150	–	μA
V_{PP}	LVDS differential output voltage peak to peak, single-ended	$V_{DD} = 3.3\text{ V}$ or 2.5 V , $R_{TERM} = 100\ \Omega$ between Q and Q# pairs ^[3, 7]	250	470	mV
ΔV_{OCM}	Change in V_{OCM} between complementary output states	$V_{DD} = 3.3\text{ V}$ or 2.5 V , $R_{TERM} = 100\ \Omega$ between Q and Q# pairs ^[3, 7]	–	50	mV
V_{BB}	Output reference voltage	0 to $150\ \mu\text{A}$ output current	1.125	1.375	V
R_{TERM}	On-chip differential input termination resistor		80	120	Ω
R_P	Internal pull-up resistance, LVCMOS logic input	CLK_EN pin	60	140	k Ω
C_{IN}	Input capacitance	Measured at 10 MHz per pin	–	3	pF

Notes

3. Refer to [Figure 2](#) on page 7.
4. I_{DD} includes current that is dissipated externally in the output termination resistors.
5. V_{ID} minimum of 400 mV is required to meet all output AC Electrical Specifications. The device is functional with V_{ID} minimum of greater than 200 mV.
6. Positive current flows into the input pin, negative current flows out of the input pin.
7. Refer to [Figure 4](#) on page 7.

AC Electrical Specifications

($V_{DD} = 3.3\text{ V} \pm 5\%$ or $2.5\text{ V} \pm 5\%$; $T_A = 0\text{ }^\circ\text{C}$ to $70\text{ }^\circ\text{C}$ (Commercial) or $-40\text{ }^\circ\text{C}$ to $85\text{ }^\circ\text{C}$ (Industrial))

Parameter	Description	Condition	Min	Typ	Max	Unit
F_{IN}	Input frequency		DC	–	1.5	GHz
F_{OUT}	Output frequency	$F_{OUT} = F_{IN}$	DC	–	1.5	GHz
$t_{PD}^{[10]}$	Propagation delay input pair to output pair	Input rise/fall time < 1.5 ns (20% to 80%)	–	–	600	ps
$t_{ODC}^{[11]}$	Output duty cycle	50% duty cycle at input Frequency range up to 1 GHz	48	–	52	%
$t_{SK1}^{[12]}$	Output-to-output skew	Any output to any output, with same load conditions at DUT	–	–	40	ps
$t_{SK1D}^{[12]}$	Device-to-device output skew	Any output to any output between two or more devices. Devices must have the same input and have the same output load.	–	–	150	ps
PN_{ADD}	Additive RMS phase noise 156.25-MHz input Rise/fall time < 150 ps (20% to 80%) $V_{ID} > 400\text{ mV}$	Offset = 1 kHz	–	–	–120	dBc/Hz
		Offset = 10 kHz	–	–	–135	dBc/Hz
		Offset = 100 kHz	–	–	–135	dBc/Hz
		Offset = 1 MHz	–	–	–150	dBc/Hz
		Offset = 10 MHz	–	–	–154	dBc/Hz
		Offset = 20 MHz	–	–	–155	dBc/Hz
$t_{JIT}^{[13]}$	Additive RMS phase jitter (Random)	156.25 MHz, 12 kHz to 20 MHz offset; input rise/fall time < 150 ps (20% to 80%), $V_{ID} > 400\text{ mV}$	–	–	0.11	ps
$t_R, t_F^{[14]}$	Output rise/fall time, single-ended	50% duty cycle at input, 20% to 80% of full swing (V_{OL} to V_{OH}) Input rise/fall time < 1.5 ns (20% to 80%) Measured at 1 GHz	–	–	300	ps
t_{SOD}	Time from clock edge to outputs disabled	Synchronous clock enable (CLK_EN) switched low	–	–	700	ps
t_{SOE}	Time from clock edge to outputs enabled	Synchronous clock enable (CLK_EN) switched high	–	–	700	ps

Notes

8. Refer to Figure 2 on page 7.
9. Refer to Figure 4 on page 7.
10. Refer to Figure 5 on page 7.
11. Refer to Figure 6 on page 7.
12. Refer to Figure 7 on page 8.
13. Refer to Figure 8 on page 8.
14. Refer to Figure 9 on page 8.

Figure 2. LVDS Output Termination

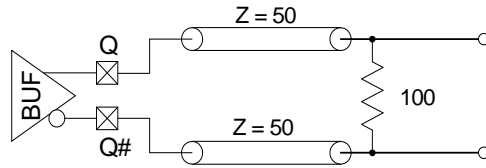

Figure 3. Input Differential and Common Mode Voltages

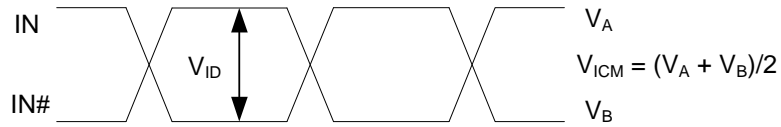

Figure 4. Output Differential and Common Mode Voltages

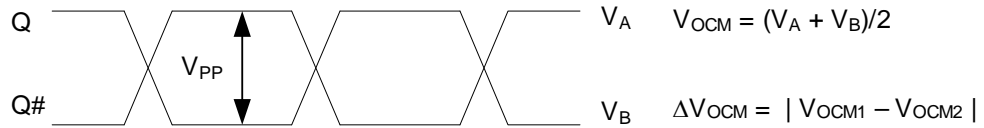

Figure 5. Input to Any Output Pair Propagation Delay

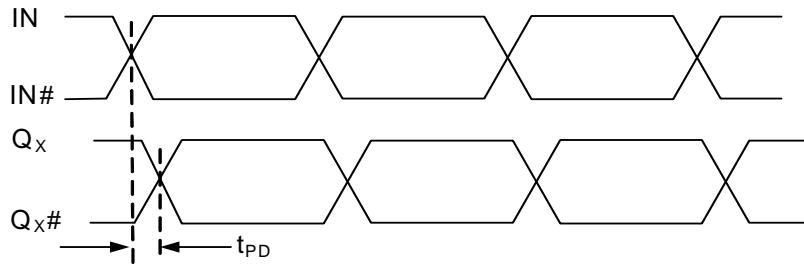

Figure 6. Output Duty Cycle

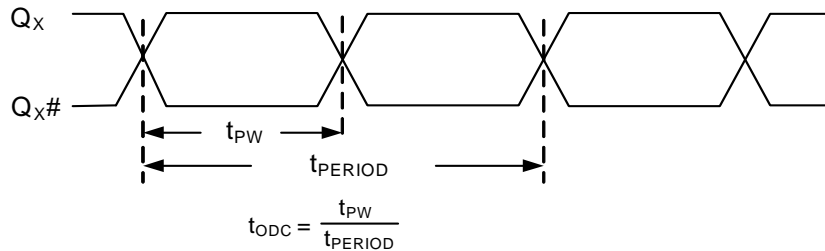

Figure 7. Output-to-output and Device-to-device Skew

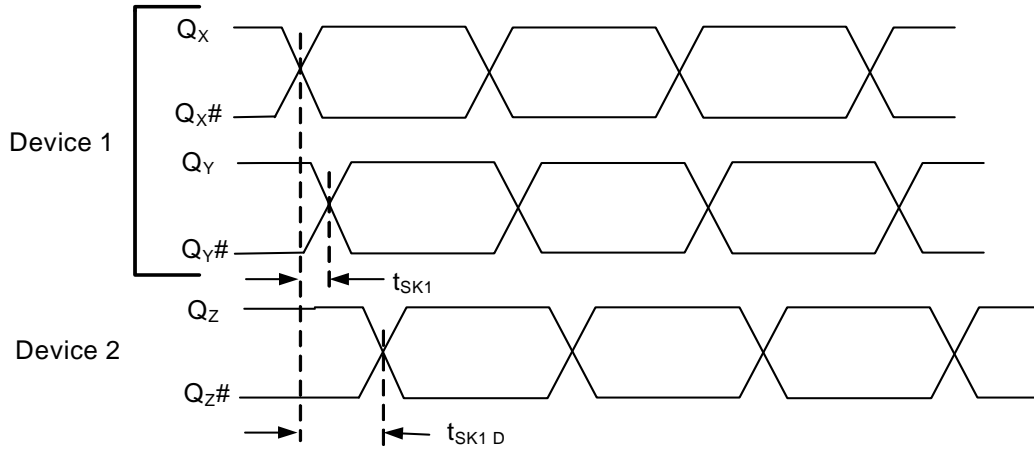

Figure 8. RMS Phase Jitter

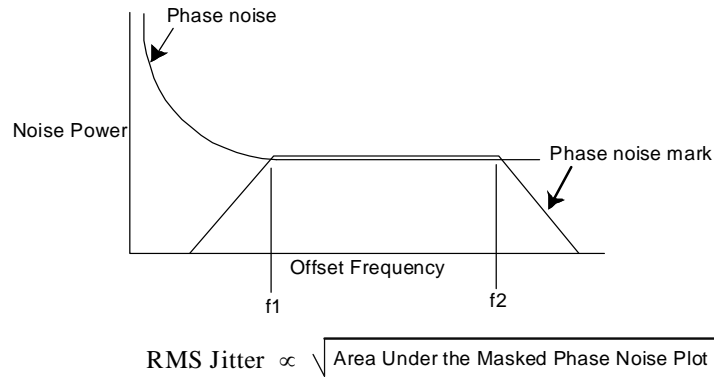

Figure 9. Output Rise/Fall Time

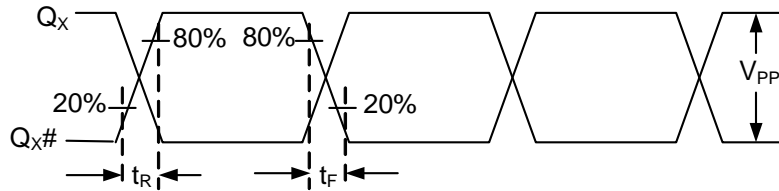
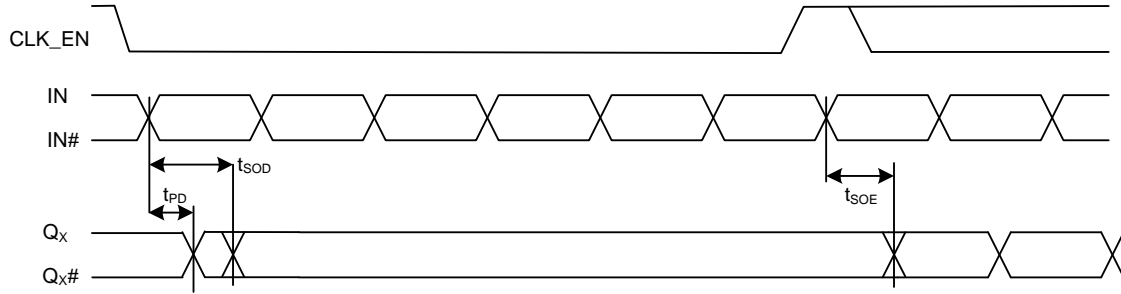

Figure 10. Synchronous Clock Enable Timing



Ordering Information

Part Number	Type	Production Flow
Pb-free		
CY2DL1510AZC	32-Pin TQFP	Commercial, 0 °C to 70 °C
CY2DL1510AZCT	32-Pin TQFP tape and reel	Commercial, 0 °C to 70 °C
CY2DL1510AZI	32-Pin TQFP	Industrial, -40 °C to 85 °C
CY2DL1510AZIT	32-Pin TQFP tape and reel	Industrial, -40 °C to 85 °C

Ordering Code Definition

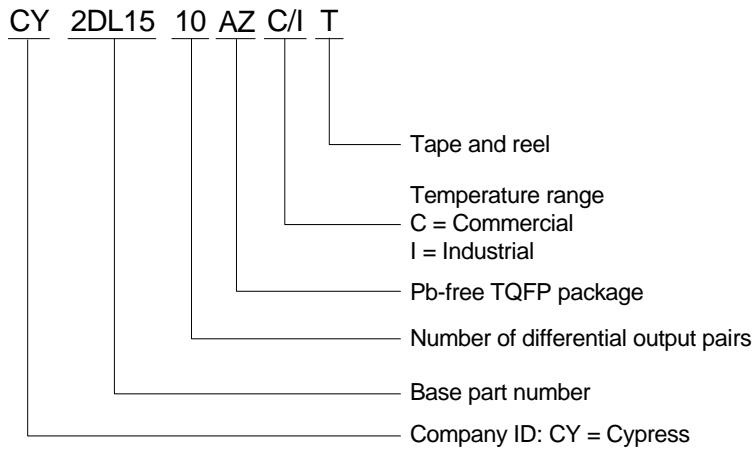

Package Dimension

Figure 11. 32-Pin Thin Plastic Quad Flat Pack 7 x 7 x 1.0 mm

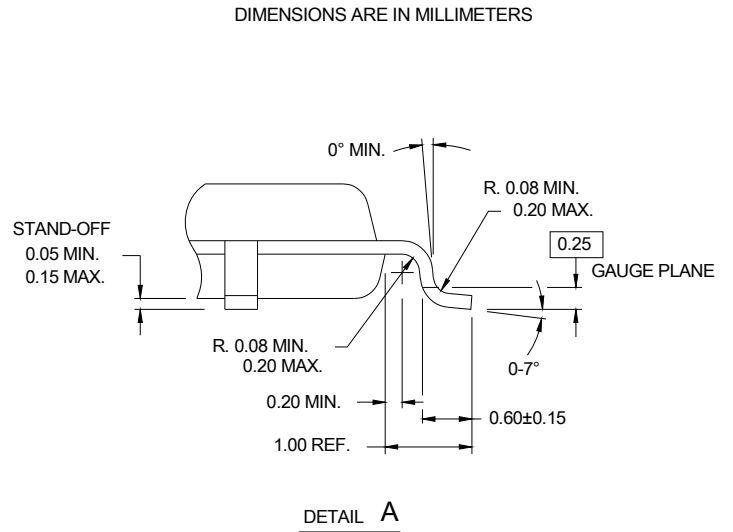
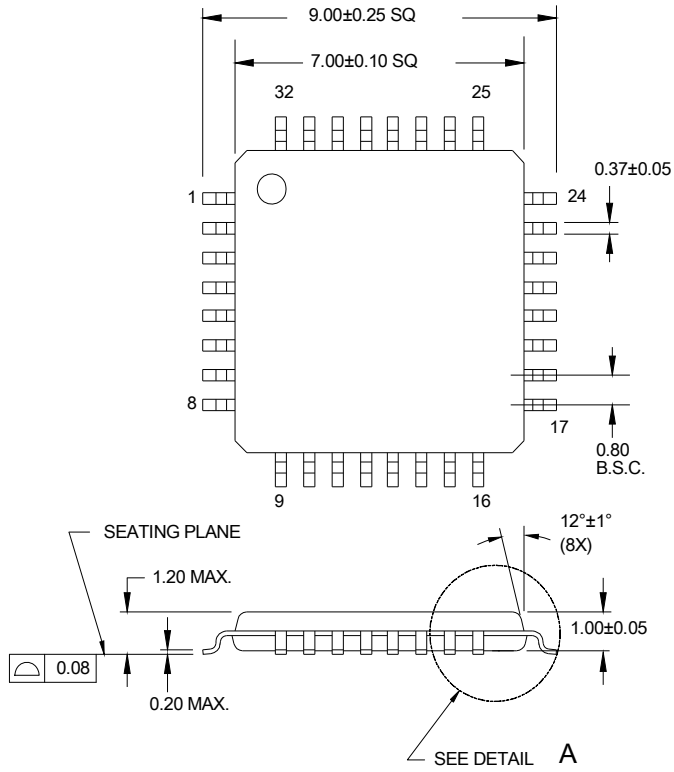

51-85063 °C

Acronyms

Table 2. Acronyms Used in this Document

Acronym	Description
ESD	electrostatic discharge
HBM	human body model
JEDEC	Joint electron devices engineering council
LVDS	low-voltage differential signal
LVC MOS	low-voltage complementary metal oxide semiconductor
LV TTL	low-voltage transistor-transistor logic
OE	Output enable
RMS	root mean square
TQFP	thin quad flat pack

Document Conventions

Table 3. Units of Measure

Symbol	Unit of Measure
°C	degree Celsius
dBc	decibels relative to the carrier
GHz	giga hertz
Hz	hertz
kΩ	kilo ohm
μA	microamperes
μF	micro Farad
μs	micro second
mA	milliamperes
ms	millisecond
mV	millivolt
MHz	megahertz
ns	nanosecond
Ω	ohm
pF	pico Farad
ps	pico second
V	volts
W	watts

Document History Page

Document Title: CY2DL1510 1:10 Differential LVDS Fanout Buffer				
Document Number: 001-54863				
Revision	ECN	Orig. of Change	Submission Date	Description of Change
**	2744225	CXQ/PYRS	08/19/09	New datasheet.
*A	2782891	CXQ	10/09/09	Updated format of Logic Block Diagram on page 1. Added T_{SOD} and T_{SOE} specs (700 ps max) to AC Specs table. Added T_{SETUP} and T_{HOLD} specs (300 ps min) to AC Specs table. Changed equation for RMS jitter in Figure 8 to proportionality. Changed package drawing from 1.4 mm thickness 51-85088 spec to 1.0 mm thickness 51-850063 spec. Added "Synchronous Clock Enable Function" to Features on page 1.
*B	2838916	CXQ	01/05/2010	Changed status from "ADVANCE" to "PRELIMINARY". Changed from 0.34 ps to 0.25 ps maximum additive jitter in "Features" on page 1 and in t_{JIT} in the AC Electrical Specs table on page 5. Added t_{PU} spec to the Operating Conditions table on page 3. Removed V_{OD} and ΔV_{OD} specs from the DC Electrical Specs table on page 4. Added V_{PP} and ΔV_{PP} specs to the AC Electrical Specs table on page 5. V_{PP} min = 250 mV and max = 470 mV; ΔV_{PP} max = 50 mV. Added internal pullup resistance spec for CLK_EN in the DC Electrical Specs table on page 4. Min = 60 k Ω , Max = 140 k Ω . Added a measurement definition for C_{IN} in the DC Electrical Specs table on page 4. Changed letter case and some names of all the timing parameters in the AC Electrical Specs table on page 5 to be consistent with EROS. Lowered all additive phase noise mask specs by 3 dB in the AC Electrical Specs table on page 5. Added condition to t_R and t_F specs in the AC Electrical specs table on page 5 that input rise/fall time must be less than 1.5 ns (20% to 80%). Changed letter case and some names of all the timing parameters in Figures 5, 6, 7, and 9, to be consistent with EROS. Updated Figure 4 with definitions for V_{PP} and ΔV_{PP} .
*C	2885033	CXQ	02/26/2010	Updated 32-Pin TQFP package diagram.
*D	3011766	CXQ	08/20/2010	Changed maximum additive jitter from 0.25 ps to 0.11 ps in "Features" on page 1 and in t_{JIT} in the AC Electrical Specs table on page 5. Changed max t_{PD} spec from 480 ps to 600 ps. Added note 5 to describe I_{IH} and I_{IL} specs. Removed reference to data distribution from "Functional Description". Changed R_P for differential inputs from 100 k Ω to 150 k Ω in the Logic Block Diagram and from 60 k Ω min / 140 k Ω max to 90 k Ω min / 210 k Ω max in the DC Electrical Specs table. Added V_{ID} max spec of 0.8V in the DC Electrical Specs table. Updated phase noise specs for 1 k/10 k/100 k/1 M/10 M/20 MHz offset to -120/-130/-135/-150/-150/-150dBc/Hz, respectively, in the AC Electrical Specs table. Added "Frequency range up to 1 GHz" condition to t_{ODC} spec. Added Acronyms and Ordering Code Definition.
*E	3017258	CXQ	08/27/2010	Corrected Output Rise/Fall time diagram.

Document Title: CY2DL1510 1:10 Differential LVDS Fanout Buffer
 Document Number: 001-54863

Revision	ECN	Orig. of Change	Submission Date	Description of Change
*F	3100234	CXQ	11/18/2010	<p>Changed V_{IN} and V_{OUT} specs from 4.0V to "lesser of 4.0 or $V_{DD} + 0.4$"</p> <p>Removed 200mA min LU spec, replaced with "Meets or exceeds JEDEC Spec JESD78B IC Latchup Test"</p> <p>Moved V_{PP} from AC spec table to DC spec table, removed ΔV_{PP}.</p> <p>Removed R_P spec for differential input clock pins IN_X and $IN_{X\#}$.</p> <p>Changed C_{IN} condition to "Measured at 10 MHz".</p> <p>Changed PN_{ADD} specs for 10kHz, 10MHz, and 20MHz offsets.</p> <p>Added "Measured at 1 GHz" to t_R, t_F spec condition.</p> <p>Removed t_S and t_H specs from AC specs table.</p> <p>Changed to CY2DL1510AZ package code in Ordering Information.</p> <p>Added to Z package code in Ordering Code Definition.</p>
*G	3135201	CXQ	01/12/2011	<p>Removed "Preliminary" status heading.</p> <p>Fixed typo and removed resistors from $IN/IN\#$ in Logic Block Diagram.</p> <p>Added Figure 10 to describe T_{SOE} and T_{SOD}.</p>
*H	3090938	CXQ	02/25/2011	Post to external web.

Sales, Solutions, and Legal Information

Worldwide Sales and Design Support

Cypress maintains a worldwide network of offices, solution centers, manufacturer's representatives, and distributors. To find the office closest to you, visit us at [Cypress Locations](#).

Products

Automotive	cypress.com/go/automotive
Clocks & Buffers	cypress.com/go/clocks
Interface	cypress.com/go/interface
Lighting & Power Control	cypress.com/go/powerpsoc cypress.com/go/plc
Memory	cypress.com/go/memory
Optical & Image Sensing	cypress.com/go/image
PSoC	cypress.com/go/psoc
Touch Sensing	cypress.com/go/touch
USB Controllers	cypress.com/go/USB
Wireless/RF	cypress.com/go/wireless

PSoC Solutions

psoc.cypress.com/solutions
[PSoC 1](#) | [PSoC 3](#) | [PSoC 5](#)

© Cypress Semiconductor Corporation, 2009-2011. The information contained herein is subject to change without notice. Cypress Semiconductor Corporation assumes no responsibility for the use of any circuitry other than circuitry embodied in a Cypress product. Nor does it convey or imply any license under patent or other rights. Cypress products are not warranted nor intended to be used for medical, life support, life saving, critical control or safety applications, unless pursuant to an express written agreement with Cypress. Furthermore, Cypress does not authorize its products for use as critical components in life-support systems where a malfunction or failure may reasonably be expected to result in significant injury to the user. The inclusion of Cypress products in life-support systems application implies that the manufacturer assumes all risk of such use and in doing so indemnifies Cypress against all charges.

Any Source Code (software and/or firmware) is owned by Cypress Semiconductor Corporation (Cypress) and is protected by and subject to worldwide patent protection (United States and foreign), United States copyright laws and international treaty provisions. Cypress hereby grants to licensee a personal, non-exclusive, non-transferable license to copy, use, modify, create derivative works of, and compile the Cypress Source Code and derivative works for the sole purpose of creating custom software and or firmware in support of licensee product to be used only in conjunction with a Cypress integrated circuit as specified in the applicable agreement. Any reproduction, modification, translation, compilation, or representation of this Source Code except as specified above is prohibited without the express written permission of Cypress.

Disclaimer: CYPRESS MAKES NO WARRANTY OF ANY KIND, EXPRESS OR IMPLIED, WITH REGARD TO THIS MATERIAL, INCLUDING, BUT NOT LIMITED TO, THE IMPLIED WARRANTIES OF MERCHANTABILITY AND FITNESS FOR A PARTICULAR PURPOSE. Cypress reserves the right to make changes without further notice to the materials described herein. Cypress does not assume any liability arising out of the application or use of any product or circuit described herein. Cypress does not authorize its products for use as critical components in life-support systems where a malfunction or failure may reasonably be expected to result in significant injury to the user. The inclusion of Cypress' product in a life-support systems application implies that the manufacturer assumes all risk of such use and in doing so indemnifies Cypress against all charges.

Use may be limited by and subject to the applicable Cypress software license agreement.