

## Table of Models

	<p>Description: <b>Standard Adapter (A)</b>                  Material: FR-4 Fiberglass Epoxy Board                  Index: -40°C to 140°C (-40°F to 284°F)                  Note: Mates with Standard Socket (S)</p>	<p>Insulator Size:                  BGA device body                  +.079/(2.00mm)</p>
	<p>Description: <b>Extraction Slot Adapter (AX)</b>                  Material: FR-4 Fiberglass Epoxy Board                  Index: -40°C to 140°C (-40°F to 284°F)                  Note: Mates with Extraction Socket (SB)</p>	<p>Insulator Size:                  BGA device body                  +.157/(4.00mm)</p>

Note: For use with LGA or reworked BGA devices, select surface mount (SMT) terminals which feature solder balls on device side. SMT Adapter terminals may also be used for surface mount board to board applications.

## Features:

- Soldering BGA Device to adapter subjects BGA to less thermal stress than soldering BGA directly to a PCB due to the adapter's lower mass.
- Uses same footprint as BGA device.
- Custom adapters available for heat sink attachment.
- Gold plated screw-machined terminals for superior durability.
- Unique SMT Adapter provides reliable solution for mounting or socketing LGA or re-worked BGA devices.
- SMT Adapters mate with our BGA Sockets for LGA to BGA conversion or SMT Board to Board applications.

## Specifications:

### Terminals:

Brass - Copper Alloy  
(C36000) ASTM-B-16

### Solder Ball:

Standard: 63Sn/37Pb  
 Lead-free: 95.5Sn/4.0Ag/0.5Cu

### Plating:

G - Gold over Nickel

Gold per ASTM-B-488

Nickel per QQ-N-290

## Options



P/N 8125

### Extraction Tool

- Insert "T" bar end of tool into extraction slot adapter.
- Slide tool to end of slot and pry adapter from socket.
- Repeat in additional slots until adapter is separated from socket.
- Works with LCP or FR-4 sockets.

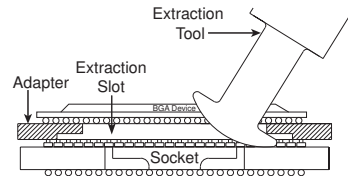

## How To Order

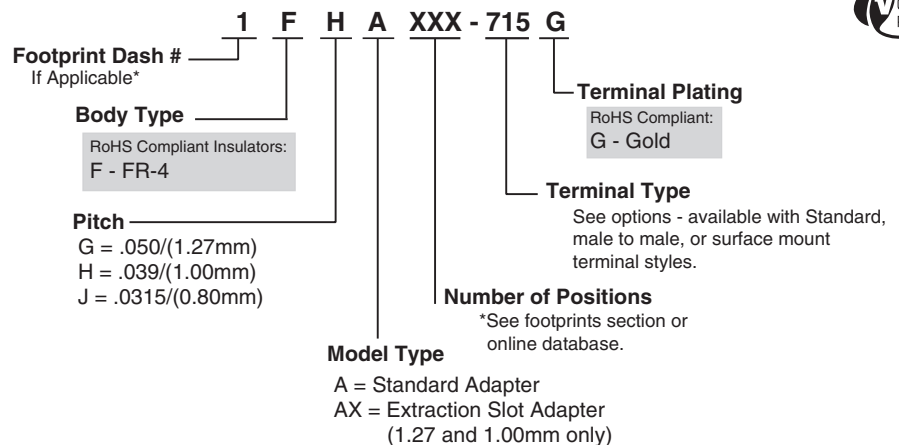

Note: See pages 4-5 for 0.50mm and 0.65mm pitch. Consult factory for custom 0.75mm pitch designs. For SMT Adapters, select Model Type A or AX and appropriate SMT Terminal Type from page 7.



5 Energy Way, West Warwick, RI 02893 USA  
 Tel: 800.424.9850 | 401.823.5200  
 Fax: 401.823.8723  
 info@advanced.com | www.advanced.com  
 Catalog 16 rev. Sept. 07

# Ball Grid Array (BGA) Adapters

For use with BGA Sockets on pages 8-9

# BGA Adapters

Additional standard and custom terminals available.  
See Terminals section or consult factory.

## Standard Terminals

Standard

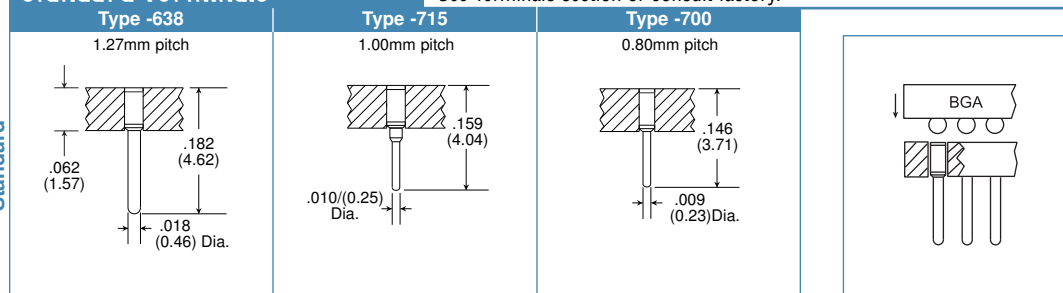

Male to Male

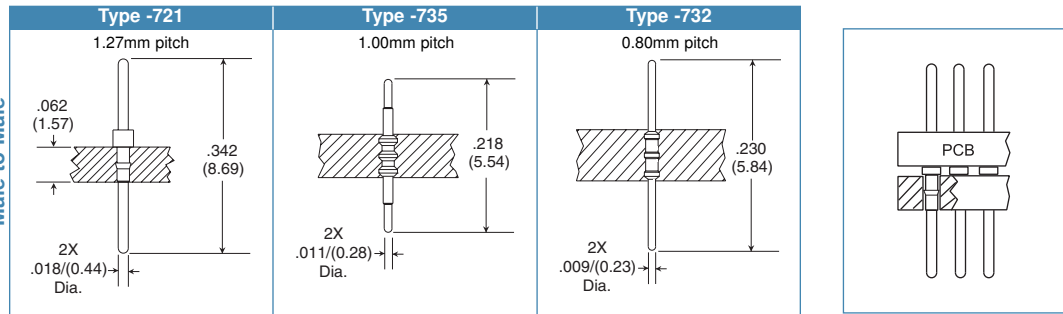

SMT (Surface Mount)

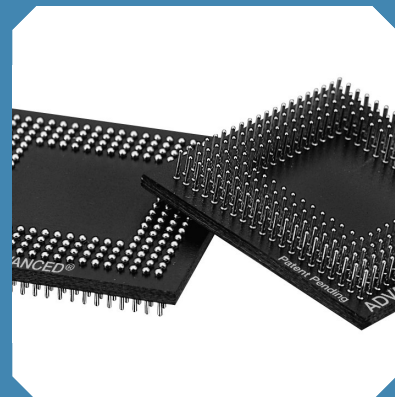
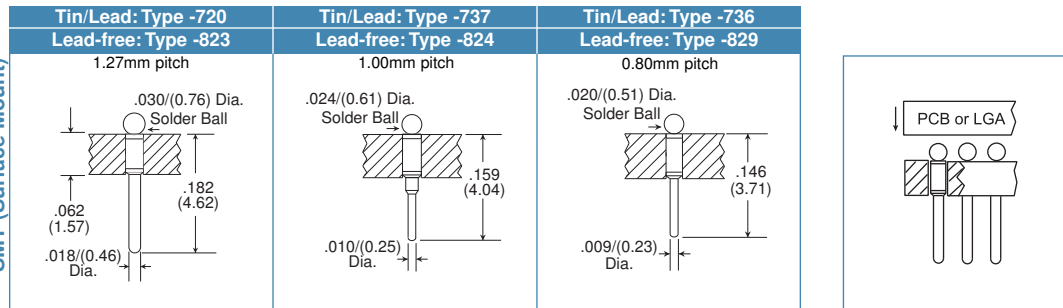

## Footprints:

360 Pins  
Footprint Number 360-2

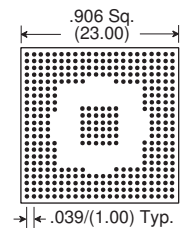

22 x 22 rows

- Footprint specific insulators drilled to exact device pattern.
- Over 1000 footprints available - see page 88, search online or submit your device specs.
- Use our Build-A-Part feature or search in our online BGA Socket Finder™ at [www.bgasockets.com](http://www.bgasockets.com).

## How It Works

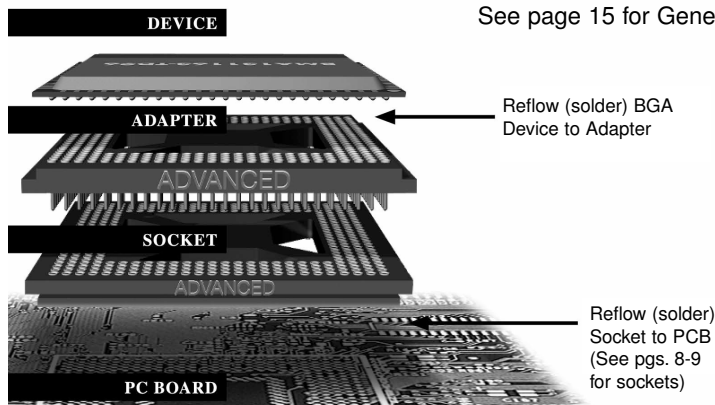

See page 15 for Generic Reflow Profiles.

- Either Tin/Lead or Lead-free device packages can be attached to our RoHS Compliant Adapters.
- PC boards can be processed with Tin/Lead BGA sockets in standard profiles or lead-free BGA sockets in RoHS Compliant, high temperature profiles.

## Dimensional Information

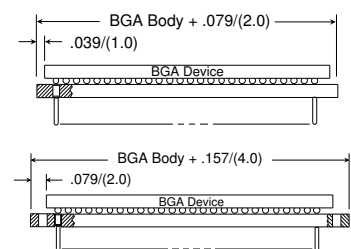

### Standard Adapter (A)

- Mates with Standard Socket (S)
- Adapter size equals BGA Device body + .079/(2.00)

### Extraction Slot Adapter (AX)

- Slots allow AIC extraction tool (sold separately) to easily remove device/adapter assembly from socket
- Mates with Extraction Socket (SB)
- Adapter size equals BGA Device body + .157/(4.00)

## Available Online:

- RoHS Qualification Test Report
- Technical articles
- Test data
- Signal Integrity Performance
- CAD Drawings
- BGA Footprints



5 Energy Way, West Warwick, RI 02893 USA  
Tel: 800.424.9850 | 401.823.5200  
Fax: 401.823.8723  
info@advanced.com | www.advanced.com  
Catalog 16 rev. Sept. 07

inch/(mm)

Products shown covered by patents issued and/or pending. Specifications subject to change without notice.

# BGA Adapter Sockets

# Ball Grid Array (BGA) Adapter Sockets

For use with BGA Adapters on pages 6-7

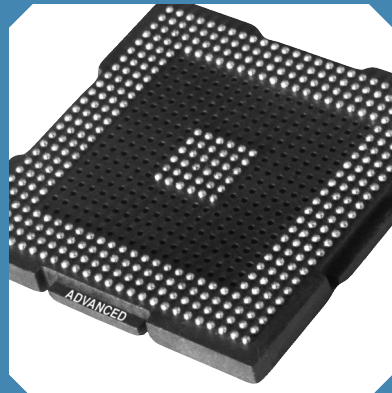

## Table of Models

	<p>Description: <b>Standard Socket (S)</b>                  Mat'l: High Temp. Liquid Crystal Polymer (LCP)*                  Index: -60°C to 260°C (-76°F to 500°F)</p>	<p>Insulator Size:                  Same size as BGA device body</p>
	<p>Description: <b>Extraction Socket (SB)</b>                  Mat'l: High Temp. Liquid Crystal Polymer (LCP)*                  Index: -60°C to 260°C (-76°F to 500°F)</p>	<p>Insulator Size:                  1.27mm Pitch:                  BGA device body                  +.079/(2.00)                   1.00mm Pitch:                  BGA device body                  +.138/(3.50)</p>

## Features:

- Advanced® exclusive solder ball terminals offer superior SMT processing.
- Same footprint as BGA device.
- Proven long-term performance in vigorous temperature cycling applications - solder ball terminal absorbs TCE mismatch.
- Closed bottom socket terminal for 100% anti-wicking of solder.
- Gold contacts allow gold/gold interconnections to Adapter pins.
- Low insertion force socket with multi-fingered high reliability Beryllium Copper contacts.
- Coplanarity consistently under .006 inch industry standard.
- Custom designs available.

## Specifications:

### Terminals:

Brass - Copper Alloy  
 (C36000) ASTM-B-16

### Contacts:

Beryllium Copper  
 (C17200) ASTM-B-194

### Solder Ball:

Standard: 63Sn/37Pb  
 Lead-free: 95.5Sn/4.0Ag/0.5Cu

### Plating:

G - Gold over Nickel  
  
 Gold per ASTM-B-488  
 Nickel per QQ-N-290

RGS/RGSB replaces MGS/MGSB, MHS/MHSB replaces FHS/FHSB.

\* Some sizes may only be available in FR-4. See How To Order section or consult factory.

## Options



### Tape and Reel Packaging

- Conforms to EIA-481 Standard.
- Pick-up tape included.
- Add -TR to end of part number when ordering.
- Custom packaging available
- If -TR is not specified, standard tray packs are used.



- Extraction tool (P/N 8125) is available separately.
- Works with Extraction Slot Adapters and LCP or FR-4 sockets.

## How To Order

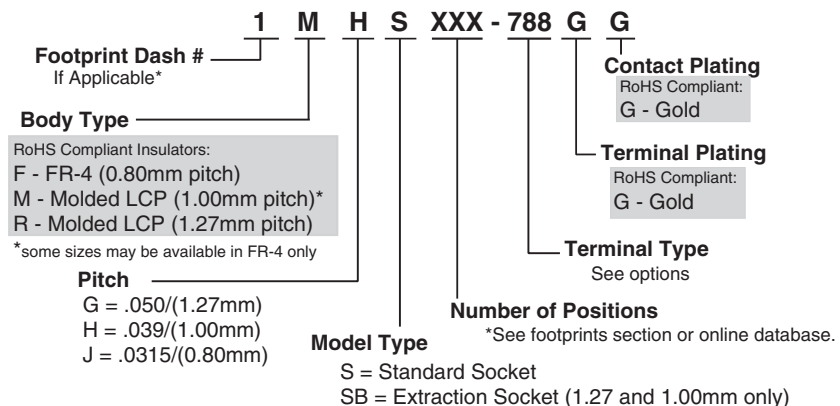

5 Energy Way, West Warwick, RI 02893 USA  
 Tel: 800.424.9850 | 401.823.5200  
 Fax: 401.823.8723  
 info@advanced.com | www.advanced.com  
 Catalog 16 rev. Sept. 07

Products shown covered by patents issued and/or pending. Specifications subject to change without notice.

inch/(mm)

Note: See pages 4-5 for 0.50mm and 0.65mm pitch.

# Ball Grid Array (BGA) Adapter Sockets

For use with BGA Adapters on pages 6-7

Additional standard and custom terminals available.  
See Terminals section or consult factory.

## Standard Terminals

SMT (Surface Mount)

Tin/Lead: Type -636 Lead-free: Type -819 1.27mm pitch	Tin/Lead: Type -790 Lead-free: Type -788 1.00mm pitch	Tin/Lead: Type -702 Lead-free: Type -828 0.80mm pitch
PATENTED	PATENTED	PATENTED

Thru-Hole

Type -673 1.27mm pitch	Type -789 1.00mm pitch	Type -731 0.80mm pitch

## How It Works

See page 15 for Generic Reflow Profiles.

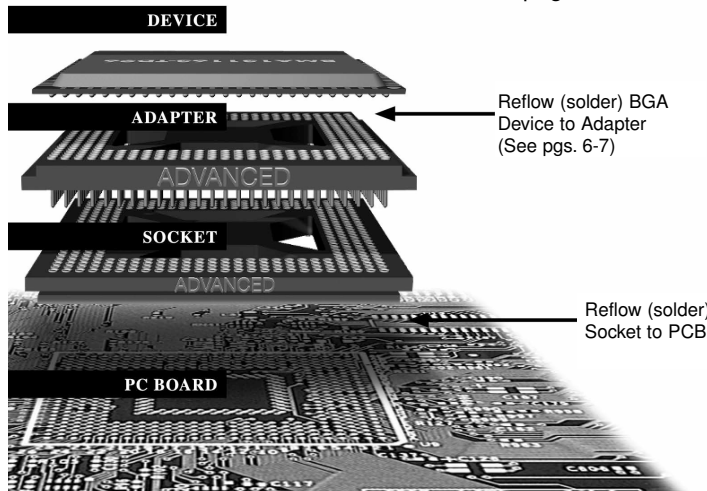

- Either Tin/Lead or Lead-free device packages can be attached to our RoHS Compliant Adapters.
- PC boards can be processed with Tin/Lead BGA sockets in standard profiles or lead-free BGA sockets in RoHS Compliant, high temperature profiles.

# BGA Adapter Sockets

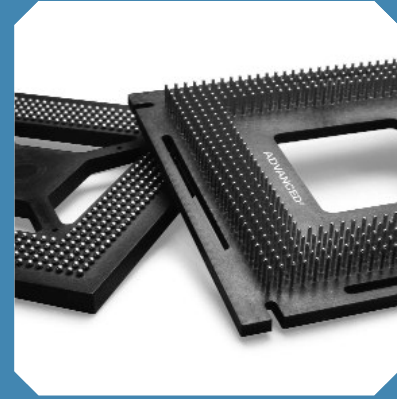

## Footprints:

360 Pins  
Footprint Number 360-2

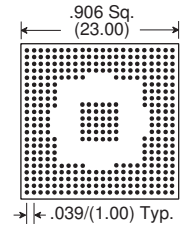

22 x 22 rows

- Full grid molded insulators populated to exact device pattern.
- Over 1000 footprints available - see page 88, search online or submit your device specs.
- Use our Build-A-Part feature or search in our online BGA Socket Finder™ at [www.bgasockets.com](http://www.bgasockets.com).

## Dimensional Information

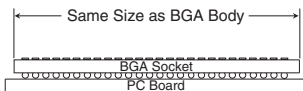

### Standard Socket (S)

- Mates with Standard Adapter (A)
- Socket size same as BGA device body
- Use with SMT Adapter for LGA and reworked BGA device socketing (or board to board applications)

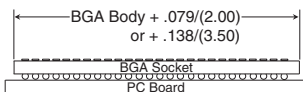

### Extraction Socket (SB)

- Mates with Extraction Slot Adapter (AX)
- Socket size equals BGA body + .079/(2.00) for 1.27mm pitch or BGA body + .138/(3.50) for 1.00mm pitch
- Protects valuable PCB during device/adapter extraction - tool never touches PCB
- Available in 1.00 and 1.27mm pitch only

inch/(mm)

Products shown covered by patents issued and/or pending. Specifications subject to change without notice.

## Available Online:

- RoHS Qualification Test Report
- Technical articles
- Test data
- Signal Integrity Performance
- CAD drawings
- Generic Tin/Lead and Lead-free Reflow Profiles



5 Energy Way, West Warwick, RI 02893 USA  
Tel: 800.424.9850 | 401.823.5200  
Fax: 401.823.8723  
info@advanced.com | www.advanced.com  
Catalog 16 rev. Sept. 07