



CYPRESS

CY28158

Spread Spectrum Timing Solution for Serverworks Chipset

Features

- Maximized EMI suppression using Cypress's spread spectrum technology
- Based on Industry Standard CK133 Pinout with all outputs compliant to CK98 specifications
- 0.5% downspread outputs deliver up to 10dB lower EMI
- 6 skew-controlled copies of CPU output
- 6 copies of PCI output (synchronous w/CPU output)
- 2 copies of 66 MHz fixed frequency 3.3V clock
- 3 copies of 16.67 MHz IOAPIC clock, synchronous to CPU clock
- 1 copy of 48 MHz USB output
- 2 copies of 14.31818 MHz reference clock
- Programmable to 133 or 100 MHz operation
- Power management control pins for clock stop and shut down
- Available in 56-pin SSOP

Key Specifications

Supply Voltages: $V_{DD33} = 3.3V \pm 5\%$
 $V_{DD25} = 2.5V \pm 5\%$
 CPU Output Jitter: <150 ps
 CPU Output Skew: <175 ps
 CPU to 3V66 Output Offset: 0.0 to 1.5 ns (CPU leads)
 CPU to IOAPIC Output Offset 1.5 to 4.0 ns (CPU leads)
 CPU to PCI Output Offset..... 0 to 4.0 ns (CPU leads)

Table 1. Pin Selectable Frequency.

SEL133/100#	CPU0:5 (MHz)	PCI
1	133	33.3
0	100	33.3

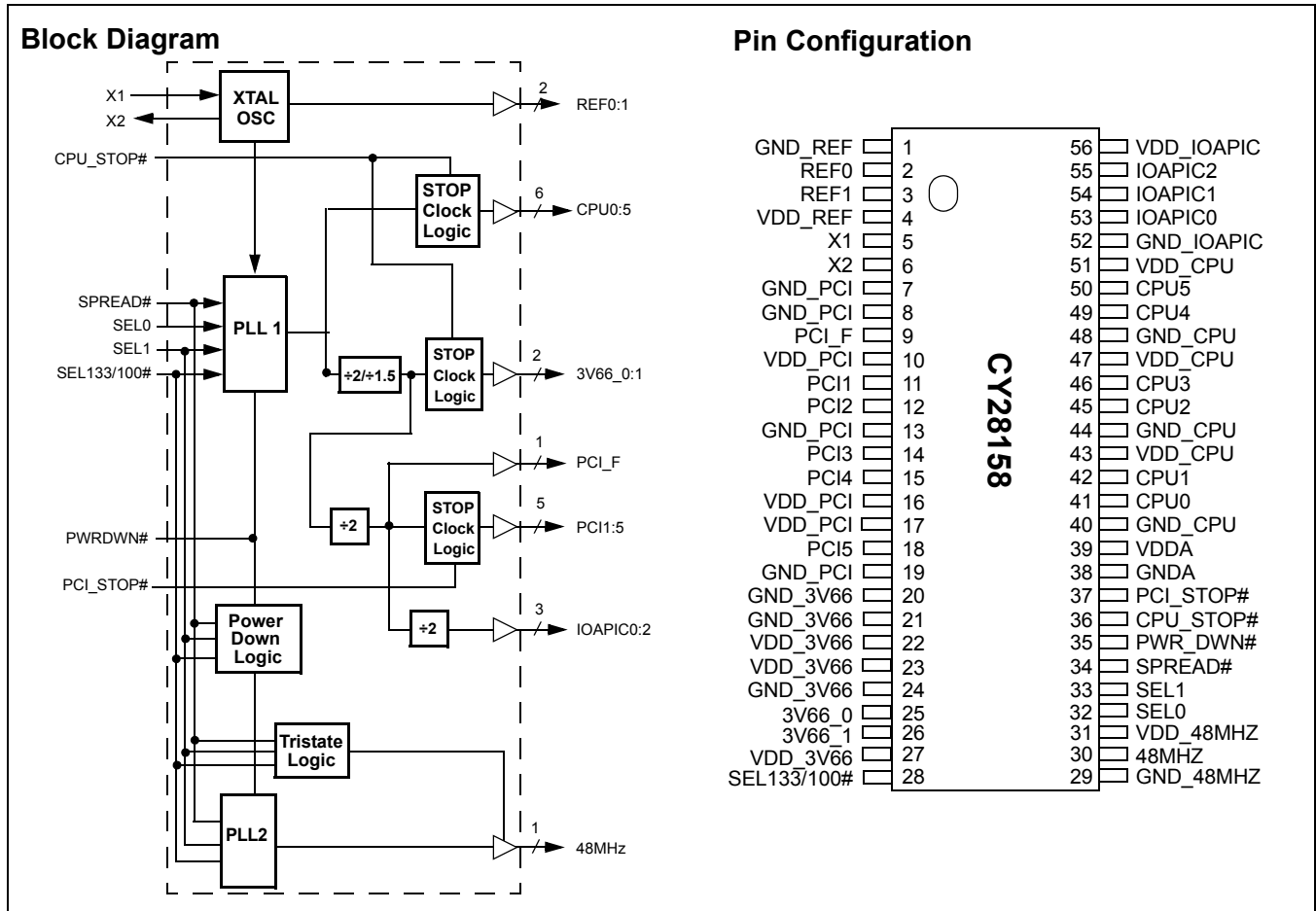

Pin Definitions

Name	Pins	Description
X1 ^[1]	5	Reference crystal input
X2 ^[1]	6	Reference crystal feedback
CPU [0–5]	41, 42, 45, 46, 49, 50	CPU clock outputs
PCI [1–5]	11, 12, 14, 15, 18	PCI clock outputs, synchronously running at 33.33 MHz
PCI_F	9	Free running PCI clock
3V66 [0–1]	25, 26	3V66 clock outputs, running at 66.66 MHz
IOAPIC [0–2]	53, 54, 55	IOAPIC clock outputs, running at 16.67 MHz
REF [0–1]	2, 3	Reference clock outputs, 14.318 MHz
48MHZ	30	48-MHz USB clock output
CPU_STOP#	36	Active LOW input, disables CPU and 3V66 clocks when asserted
PCI_STOP#	37	Active LOW input, disables PCI clocks when asserted
PWR_DWN#	35	Active LOW input, powers down part when asserted
SPREAD#	34	Active LOW input, enables spread spectrum when asserted
SEL1	33	CPU frequency select input (See Function Table)
SEL0	32	CPU frequency select input (See Function Table)
SEL133/100#	28	CPU frequency select input (See Function Table)
GND_REF	1	3.3V Reference ground
GND_PCI	7, 8, 13, 19	3.3V PCI ground
GND_3V66	20, 21, 24	3.3V 66-MHz (AGP) ground
GND_48MHZ	29	3.3V 48-MHz (USB) ground
GND_IOAPIC	52	2.5V APIC ground
GND_CPU	40, 44, 48	2.5V CPU ground
GND_A	38	Analog ground to PLL and Core
VDD_REF	4	3.3V Reference voltage supply
VDD_PCI	10, 16, 17	3.3V PCI voltage supply
VDD_3V66	22, 23, 27	3.3V 66-MHz (AGP) voltage supply
VDD_48MHZ	31	3.3V 48-MHz (USB) voltage supply
VDD_IOAPIC	56	2.5V APIC voltage supply
VDD_CPU	43, 47, 51	2.5V CPU voltage supply
VDDA	39	Analog voltage supply to PLL and Core

Note:

- For best accuracy, use a parallel-resonant crystal, $C_{LOAD} = 18$ pF. For crystals with different C_{LOAD} , please refer to the application note, "Crystal Oscillator Topics."

Function Table^[2]

SEL133 /100#	SEL1	SEL0	CPU (MHz)	3V66 (MHz)	PCI (MHz)	48MHZ (MHz)	REF (MHz)	IOAPIC (MHz)
0	0	0	Hi-Z	Hi-Z	Hi-Z	Hi-Z	Hi-Z	Hi-Z
0	0	1	100.227 ^[3]	66.818 ^[3]	33.409 ^[3]	48.008 ^[3]	14.318 ^[3]	16.705 ^[3]
0	1	0	100	66.67	33.33	OFF	14.318	16.67
0	1	1	100	66.67	33.33	48.008 ^[3]	14.318	16.67
1	0	0	TCLK/2	TCLK/4	TCLK/8	TCLK/2	TCLK	TCLK/16
1	0	1	N/A	N/A	N/A	N/A	N/A	N/A
1	1	0	133.33	66.67	33.33	OFF	14.318	16.67
1	1	1	133.33	66.67	33.33	48.008 ^[3]	14.318	16.67

Actual Clock Frequency Values

Clock Output	Target Frequency (MHz)	Actual Frequency (MHz)	PPM
CPU	100.0	99.126	-8740
CPU	133.33	132.769	-4208
48MHZ	48.0	48.008	167

Clock Enable Configuration

CPU_STOP#	PWR_DWN#	PCI_STOP#	CPU	3V66	PCI	PCI_F	REF IOAPIC	OSC.	VCOs
X	0	X	LOW	LOW	LOW	LOW	LOW	OFF	OFF
0	1	0	LOW	LOW	LOW	ON	ON	ON	ON
0	1	1	LOW	LOW	ON	ON	ON	ON	ON
1	1	0	ON	ON	LOW	ON	ON	ON	ON
1	1	1	ON	ON	ON	ON	ON	ON	ON

Clock Driver Impedances

Buffer Name	V _{DD} Range	Buffer Type	Impedance		
			Minimum Ω	Typical Ω	Maximum Ω
CPU, IOAPIC	2.375V – 2.625V	Type 1	13.5	29	45
48MHZ, REF	3.135V – 3.465V	Type 3	20	40	60
PCI, 3V66	3.135V – 3.465V	Type 5	12	30	55

Note:

2. TCLK is a test clock driven in on the X1 input in test mode.
3. This selection is defined as "N/A" or "Reserved."

Maximum Ratings

(Above which the useful life may be impaired. For user guidelines, not tested.)

Supply Voltage -0.5 to +7.0V
 Input Voltage -0.5V to $V_{DD}+0.5$

Storage Temperature (Non-Condensing) ... -65°C to +150°C
 Max. Soldering Temperature (10 sec) +260°C
 Junction Temperature +150°C
 Package Power Dissipation 1W
 Static Discharge Voltage
 (per MIL-STD-883, Method 3015) >2000V

Operating Conditions^[4] Over which Electrical Parameters are Guaranteed

Parameter	Description	Min.	Max.	Unit
V_{DD_REF} , V_{DD_PCI} , V_{DDA} , V_{DD_3V66} , V_{DD_48MHZ}	3.3V Supply Voltages	3.135	3.465	V
V_{DD_CPU}	CPU Supply Voltage	2.375	2.625	V
V_{DD_IOAPIC}	IOAPIC Supply Voltage	2.375	2.625	V
T_A	Operating Temperature, Ambient	0	70	°C
C_L	Max. Capacitive Load on CPU, 48MHZ, REF, IOAPIC PCI, 3V66		20 30	pF
$f_{(REF)}$	Reference Frequency, Oscillator Nominal Value	14.318	14.318	MHz

Electrical Characteristics Over the Operating Range

Parameter	Description	Test Conditions	Min.	Max.	Unit
V_{IH}	High-level Input Voltage	Except Crystal Pads. Threshold voltage for crystal pads = $V_{DD}/2$	2.0		V
V_{IL}	Low-level Input Voltage	Except Crystal Pads		0.8	V
V_{OH}	High-level Output Voltage	CPU, IOAPIC 48 MHZ, REF, PCI, 3V66	$I_{OH} = -1$ mA	2.0	V
			$I_{OH} = -1$ mA	2.4	
V_{OL}	Low-level Output Voltage	CPU, IOAPIC 48 MHZ, REF, PCI, 3V66	$I_{OL} = 1$ mA	0.4	V
			$I_{OL} = 1$ mA	0.4	
I_{IH}	Input High Current	$0 \leq V_{IN} \leq V_{DD}$		10	μA
I_{IL}	Input Low Current	$0 \leq V_{IN} \leq V_{DD}$		10	μA
I_{OH}	High-level Output Current	CPU	$V_{OH} = 2.0V$	-16	mA
				-60	
		IOAPIC	$V_{OH} = 2.0V$	-20	
				-72	
		48 MHZ, REF	$V_{OH} = 2.4V$	-15	
				-51	
		3V66, PCI	$V_{OH} = 2.4V$	-30	
				-100	
I_{OL}	Low-level Output Current	CPU	$V_{OL} = 0.4V$	19	mA
				49	
		IOAPIC	$V_{OL} = 0.4V$	25	
				58	
		48 MHZ, REF	$V_{OL} = 0.4V$	10	
		3V66, PCI	$V_{OL} = 0.4V$	24	
				49	
I_{OZ}	Output Leakage Current	Three-state		10	μA
I_{DD2}	2.5V Power Supply Current	$V_{DDA}/V_{DD33} = 3.465V$, $V_{DD25} = 2.625V$, $F_{CPU} = 133$ MHz		90	mA

Electrical Characteristics Over the Operating Range (continued)

Parameter	Description	Test Conditions	Min.	Max.	Unit
I_{DD3}	3.3V Power Supply Current	$V_{DDA}/V_{DD33} = 3.465V$, $V_{DD25} = 2.625V$, $F_{CPU} = 133\text{ MHz}$		160	mA
I_{DDPD2}	2.5V Shutdown Current	$V_{DDA}/V_{DD33} = 3.465V$, $V_{DD25} = 2.625V$		100	μA
I_{DDPD3}	3.3V Shutdown Current	$V_{DDA}/V_{DD33} = 3.465V$, $V_{DD25} = 2.625V$		200	μA

Switching Characteristics^[5] Over the Operating Range

Parameter	Output	Description	Test Conditions	Min.	Max.	Unit
t_1	All	Output Duty Cycle ^[6]	t_{1A}/t_{1B}	45	55	%
t_2	CPU, IOAPIC	Rising Edge Rate	Between 0.4V and 2.0V	1.0	4.0	V/ns
t_2	48MHZ, REF	Rising Edge Rate	Between 0.4V and 2.4V	0.5	2.0	V/ns
t_2	PCI, 3V66	Rising Edge Rate	Between 0.4V and 2.4V	1.0	4.0	V/ns
t_3	CPU, IOAPIC	Falling Edge Rate	Between 2.0V and 0.4V	1.0	4.0	V/ns
t_3	48MHZ, REF	Falling Edge Rate	Between 2.4V and 0.4V	0.5	2.0	V/ns
t_3	PCI, 3V66	Falling Edge Rate	Between 2.4V and 0.4V	1.0	4.0	V/ns
t_6	CPU	CPU-CPU Skew	Measured at 1.25V		175	ps
t_8	IOAPIC	IOAPIC-IOAPIC Skew	Measured at 1.25V		250	ps
t_9	3V66	3V66-3V66 Skew	Measured at 1.5V		250	ps
t_{10}	PCI	PCI-PCI Skew	Measured at 1.5V		500	ps
t_{11}	CPU, 3V66	CPU-3V66 Clock Skew	CPU leads. Measured at 1.25V for 2.5V clocks and 1.5V for 3.3V clocks	0	1.5	ns
t_{12}	3V66, PCI	3V66-PCI Clock Skew	3V66 leads. Measured at 1.5V	0.5	2.5	ns
t_{13}	CPU, IOAPIC	CPU-IOAPIC Clock Skew	CPU leads. Measured at 1.25V	1.5	4	ns
	CPU	Cycle-Cycle Clock Jitter	With all outputs running		150	ps
	IOAPIC	Cycle-Cycle Clock Jitter			500	ps
	48MHZ	Cycle-Cycle Clock Jitter			500	ps
	3V66	Cycle-Cycle Clock Jitter			500	ps
	REF	Cycle-Cycle Clock Jitter			1000	ps
	CPU, PCI	Settle Time	CPU and PCI clock stabilization from power-up		3	ms

Notes:

4. Multiple Supplies: The voltage on any input or I/O pin cannot exceed the power pin during power-up. Power supply sequencing is NOT required.
5. All parameters specified with loaded outputs.
6. Duty cycle is measured at 1.5V when $V_{DD} = 3.3V$. When $V_{DD} = 2.5V$, duty cycle is measured at 1.25V.

Switching Waveforms

Duty Cycle Timing

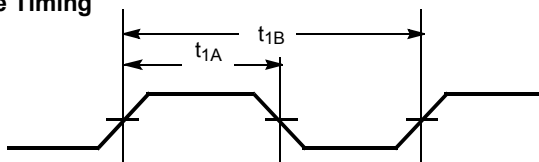

All Outputs Rise/Fall Time

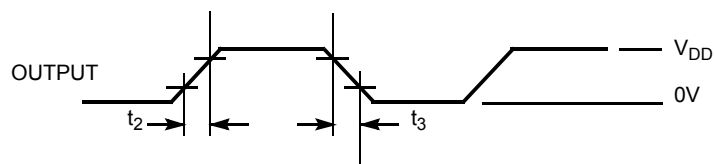

CPU-CPU Clock Skew

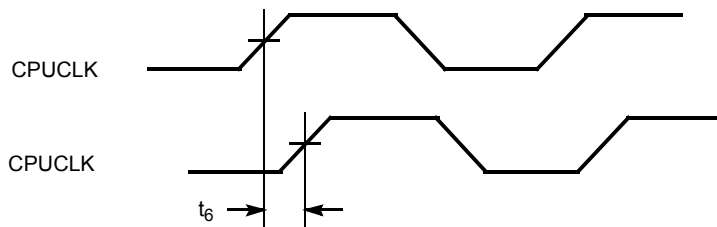

IOAPIC-IOAPIC Clock Skew

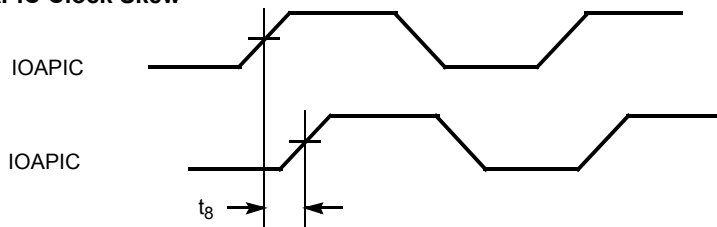

3V66 - 3V66 Clock Skew

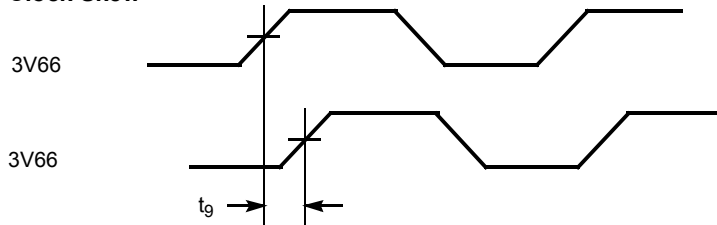

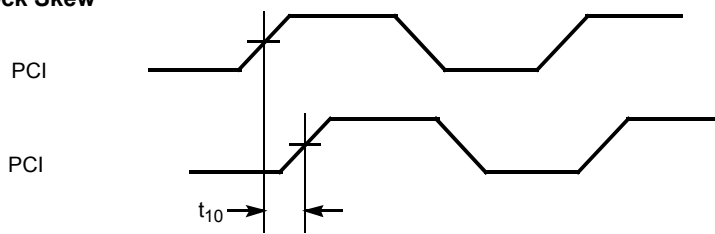
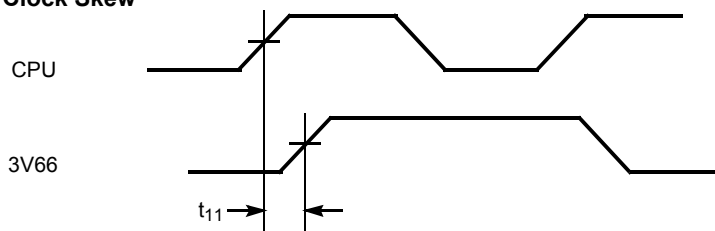
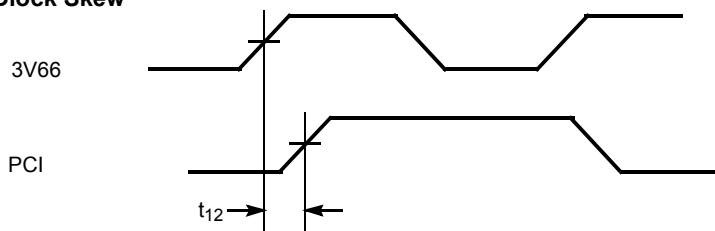
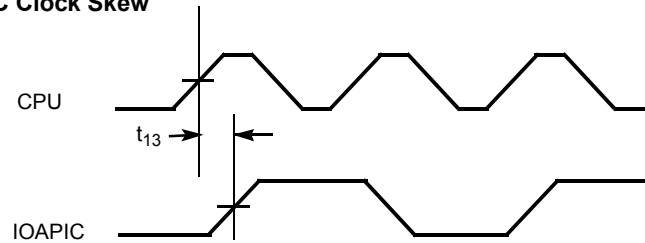
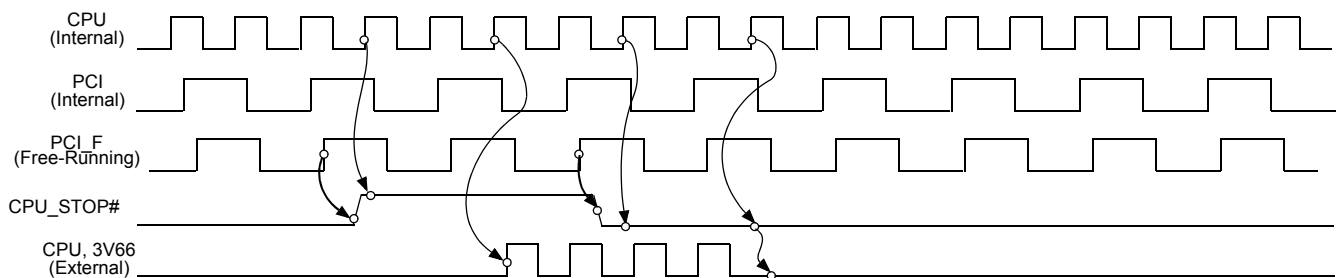
Switching Waveforms (continued)
PCI-PCI Clock Skew

CPU - 3V66 Clock Skew

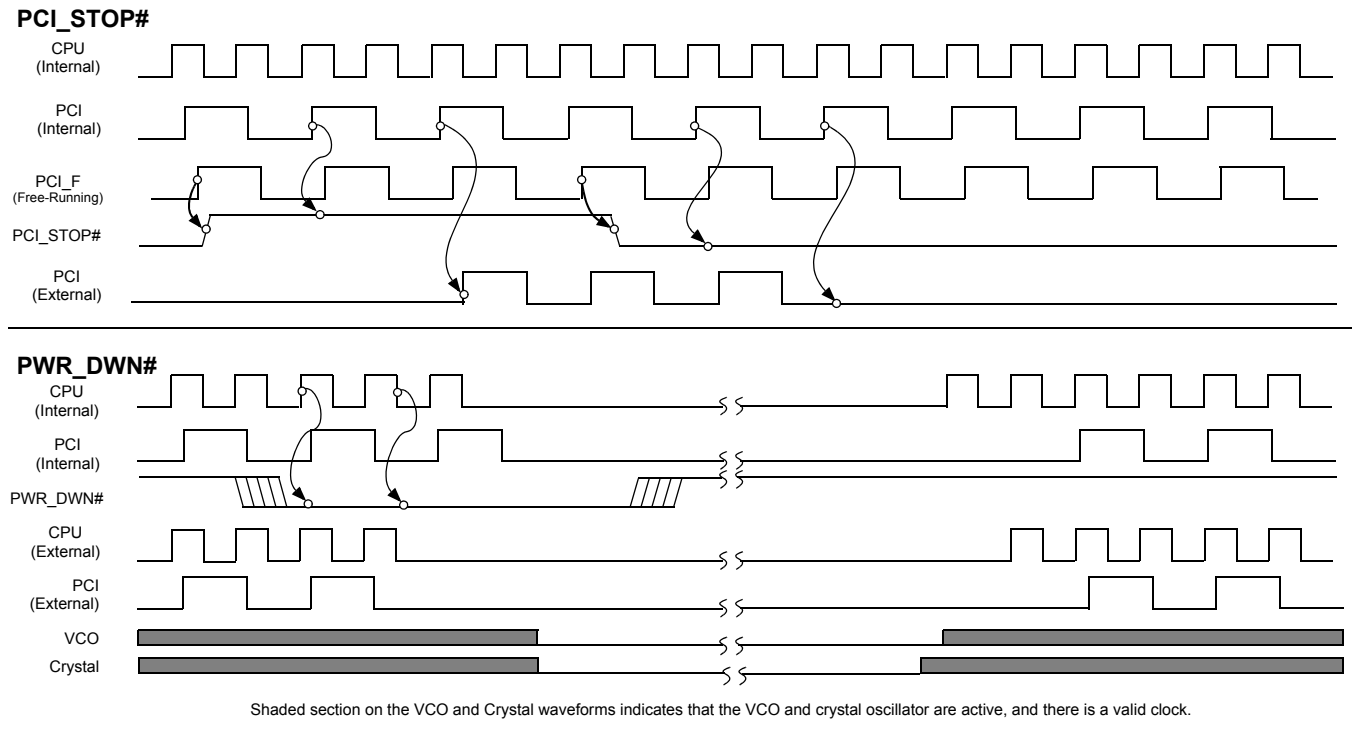
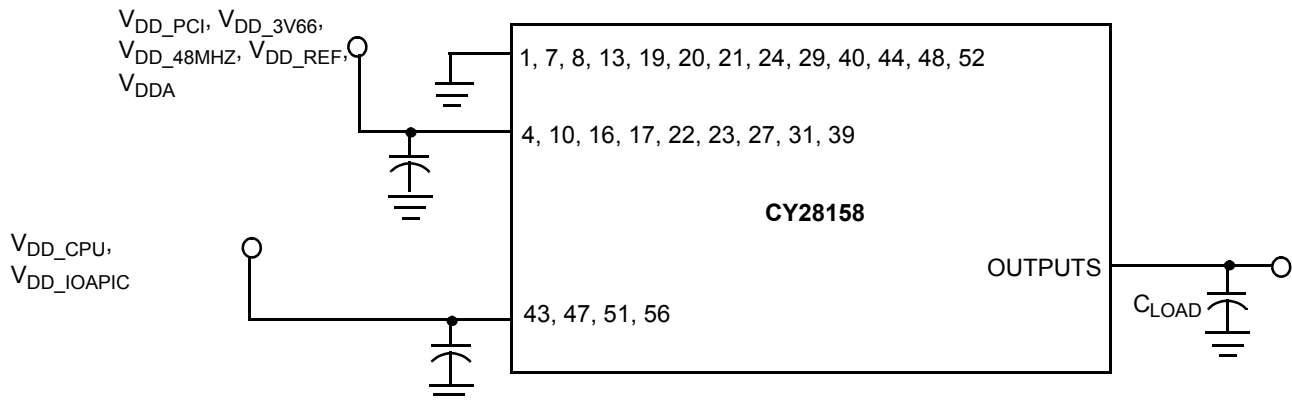
3V66 - PCI Clock Skew

CPU-IOAPIC Clock Skew

CPU_STOP# Timing^[7, 8]

Notes:

7. CPU on and CPU off latency is 2 or 3 CPU cycles.
8. CPU_STOP# may be applied asynchronously. It is synchronized internally.

Switching Waveforms (continued)

Test Circuit

Note: Each supply pin must have an individual decoupling capacitor on test circuit at 0.1 μ F.

Note: All capacitors must be placed as close to the pins as is physically possible.

Ordering Information

Ordering Code	Package Name	Package Type	Operating Range
CY28158PVC	O56	56-Pin SSOP	Commercial
CY28158PVCT	O56	56-Pin SSOP- Tape and Reel	Commercial
Lead Free			
CY28158OXC	O56	56-Pin SSOP	Commercial
CY28158OXCT	O56	56-Pin SSOP- Tape and Reel	Commercial

Package Diagram

56-Lead Shrunken Small Outline Package O56

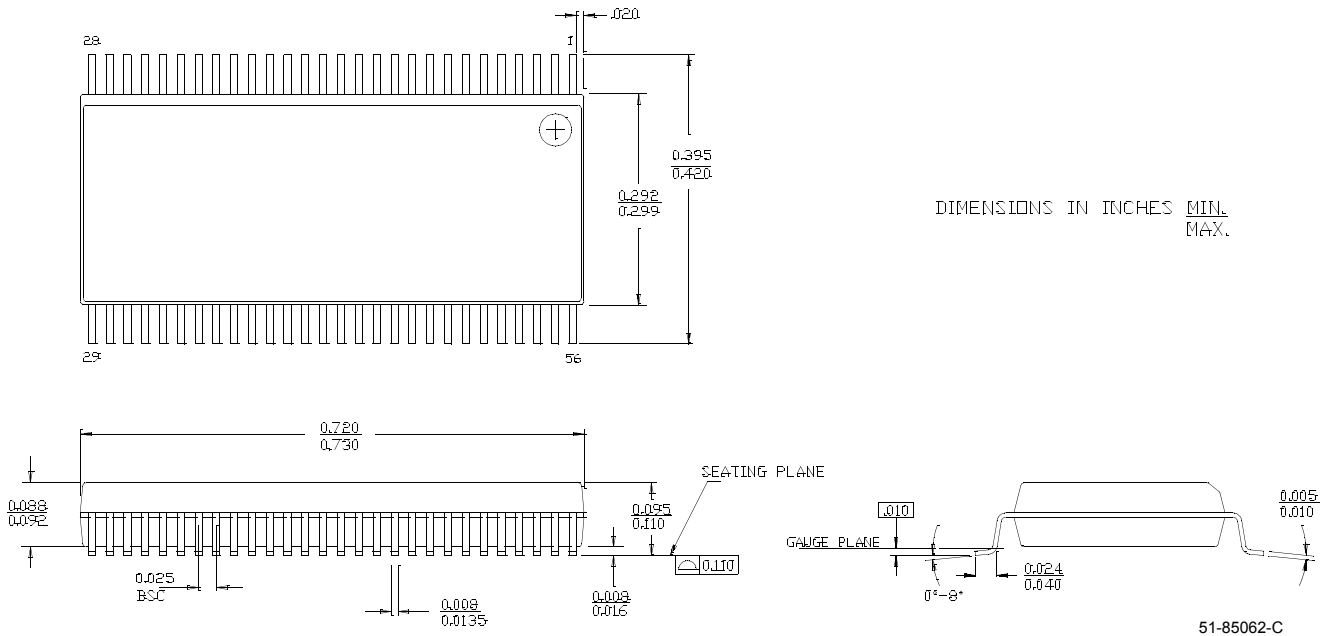

Document Title: CY28158 Spread Spectrum Timing Solution for Serverworks Chipset
Document Number: 38-07039

REV.	ECN NO.	Issue Date	Orig. of Change	Description of Change
**	107005	08/08/01	IKA	New Data Sheet
*A	122732	12/16/02	RBI	Added power-up requirements to operating conditions information.
*B	237871	See ECN	RGL	Added Lead Free Devices