

Smart Highside Power Switch

Features

- Overload protection
- Current limitation
- Short-circuit protection
- Thermal shutdown
- Overvoltage protection (including load dump)
- Fast demagnetization of inductive loads
- Reverse battery protection¹⁾
- Undervoltage and overvoltage shutdown with auto-restart and hysteresis
- CMOS diagnostic output
- Open load detection in ON-state
- CMOS compatible input
- Loss of ground and loss of V_{bb} protection²⁾
- Electrostatic discharge (ESD) protection

Product Summary

Overvoltage protection	$V_{bb(AZ)}$	63 V
Operating voltage	$V_{bb(on)}$	4.5 ... 42 V
On-state resistance	R_{ON}	18 m Ω
Load current (ISO)	$I_{L(ISO)}$	21 A
Current limitation	$I_{L(SCr)}$	70 A

Application

- μ C compatible power switch with diagnostic feedback for 12 V and 24 V DC grounded loads
- All types of resistive, inductive and capacitive loads
- Replaces electromechanical relays and discrete circuits

General Description

N channel vertical power FET with charge pump, ground referenced CMOS compatible input and diagnostic feedback, integrated in Smart SIPMOS[®] chip on chip technology. Fully protected by embedded protection functions.

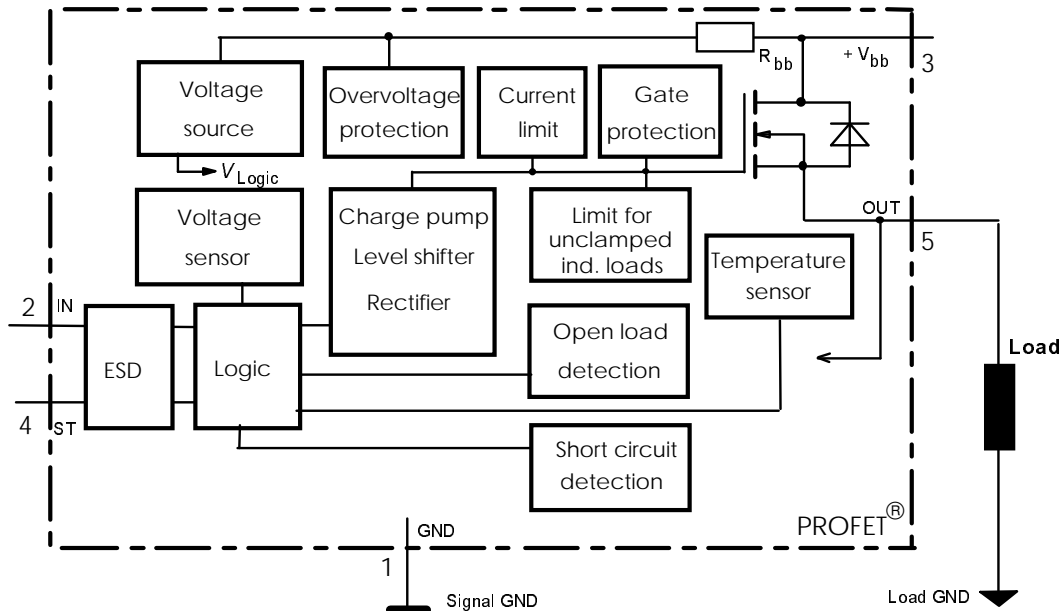
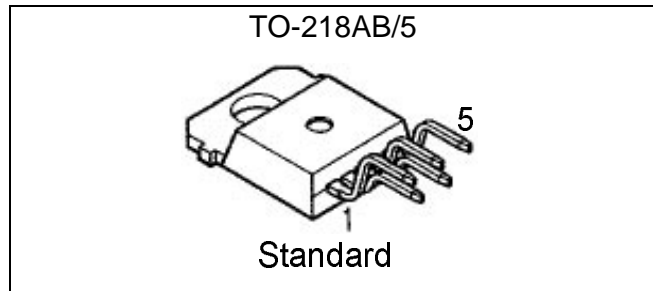

1) No external components required, reverse load current limited by connected load.

2) Additional external diode required for charged inductive loads

Pin	Symbol		Function
1	GND	-	Logic ground
2	IN	I	Input, activates the power switch in case of logical high signal
3	V _{bb}	+	Positive power supply voltage, the tab is shorted to this pin
4	ST	S	Diagnostic feedback, low on failure
5	OUT (Load, L)	O	Output to the load

Maximum Ratings at $T_j = 25\text{ °C}$ unless otherwise specified

Parameter	Symbol	Values	Unit	
Supply voltage (overvoltage protection see page 3)	V_{bb}	63	V	
Load dump protection $V_{LoadDump} = U_A + V_s$, $U_A = 13.5\text{ V}$ $R_I = 2\ \Omega$, $R_L = 1.1\ \Omega$, $t_d = 200\text{ ms}$, IN= low or high	$V_{Load\ dump}^{3)}$	80	V	
Load current (Short-circuit current, see page 4)	I_L	self-limited	A	
Operating temperature range	T_j	-40 ... +150	°C	
Storage temperature range	T_{stg}	-55 ... +150		
Power dissipation (DC)	P_{tot}	167	W	
Inductive load switch-off energy dissipation, single pulse $T_j = 150\text{ °C}$:	E_{AS}	2.1	J	
Electrostatic discharge capability (ESD) (Human Body Model)	V_{ESD}	2.0	kV	
Input voltage (DC)	V_{IN}	-0.5 ... +6	V	
Current through input pin (DC)	I_{IN}	±5.0	mA	
Current through status pin (DC)	I_{ST}	±5.0		
see internal circuit diagrams page 6...				
Thermal resistance	chip - case: junction - ambient (free air):	R_{thJC} R_{thJA}	≤ 0.75 ≤ 45	K/W

³⁾ $V_{Load\ dump}$ is setup without the DUT connected to the generator per ISO 7637-1 and DIN 40839

Electrical Characteristics

Parameter and Conditions at $T_j = 25\text{ °C}$, $V_{bb} = 12\text{ V}$ unless otherwise specified	Symbol	Values			Unit
		min	typ	max	

Load Switching Capabilities and Characteristics

On-state resistance (pin 3 to 5) $I_L = 5\text{ A}$	$T_j = 25\text{ °C}$: $T_j = 150\text{ °C}$:	R_{ON}	--	15 28	18 35	mΩ
Nominal load current (pin 3 to 5) ISO Proposal: $V_{ON} = 0.5\text{ V}$, $T_C = 85\text{ °C}$		$I_{L(ISO)}$	17	21	--	A
Output current (pin 5) while GND disconnected or GND pulled up, $V_{IN} = 0$, see diagram page 7, $T_j = -40\dots+150\text{ °C}$		$I_{L(GNDhigh)}$	--	--	1	mA
Turn-on time to 90% V_{OUT} :		t_{on}	100	--	350	μs
Turn-off time to 10% V_{OUT} :		t_{off}	10	--	130	μs
$R_L = 12\text{ Ω}$, $T_j = -40\dots+150\text{ °C}$						
Slew rate on 10 to 30% V_{OUT} , $R_L = 12\text{ Ω}$, $T_j = -40\dots+150\text{ °C}$		dV/dt_{on}	0.2	--	2	V/μs
Slew rate off 70 to 40% V_{OUT} , $R_L = 12\text{ Ω}$, $T_j = -40\dots+150\text{ °C}$		$-dV/dt_{off}$	0.4	--	5	V/μs

Operating Parameters

Operating voltage ⁴⁾	$T_j = -40\dots+150\text{ °C}$:	$V_{bb(on)}$	4.5	--	42	V
Undervoltage shutdown	$T_j = -40\dots+150\text{ °C}$:	$V_{bb(under)}$	2.4	--	4.5	V
Undervoltage restart	$T_j = -40\dots+150\text{ °C}$:	$V_{bb(u\ rst)}$	--	--	4.5	V
Undervoltage restart of charge pump see diagram page 12	$T_j = -40\dots+150\text{ °C}$:	$V_{bb(ucp)}$	--	6.5	7.5	V
Undervoltage hysteresis $\Delta V_{bb(under)} = V_{bb(u\ rst)} - V_{bb(under)}$		$\Delta V_{bb(under)}$	--	0.2	--	V
Overvoltage shutdown	$T_j = -40\dots+150\text{ °C}$:	$V_{bb(over)}$	42	--	52	V
Overvoltage restart	$T_j = -40\dots+150\text{ °C}$:	$V_{bb(o\ rst)}$	42	--	--	V
Overvoltage hysteresis	$T_j = -40\dots+150\text{ °C}$:	$\Delta V_{bb(over)}$	--	0.2	--	V
Overvoltage protection ⁵⁾ $I_{bb} = 40\text{ mA}$	$T_j = -40\text{ °C}$: $T_j = 25\dots+150\text{ °C}$:	$V_{bb(AZ)}$	60 63	-- 67	--	V
Standby current (pin 3) $V_{IN} = 0$, $I_{ST} = 0$,	$T_j = -40\dots+25\text{ °C}$: $T_j = 150\text{ °C}$:	$I_{bb(off)}$	-- --	12 18	25 60	μA
Leakage output current (included in $I_{bb(off)}$) $V_{IN} = 0$		$I_{L(off)}$	--	6	--	μA
Operating current (Pin 1) ⁶⁾ , $V_{IN} = 5\text{ V}$		I_{GND}	--	1.1	--	mA

⁴⁾ At supply voltage increase up to $V_{bb} = 6.5\text{ V}$ typ without charge pump, $V_{OUT} \approx V_{bb} - 2\text{ V}$

⁵⁾ see also $V_{ON(CL)}$ in table of protection functions and circuit diagram page 7. Measured without load

⁶⁾ Add I_{ST} , if $I_{ST} > 0$, add I_{IN} , if $V_{IN} > 5.5\text{ V}$

Parameter and Conditions at $T_j = 25\text{ °C}$, $V_{bb} = 12\text{ V}$ unless otherwise specified	Symbol	Values			Unit
		min	typ	max	
Protection Functions					
Initial peak short circuit current limit (pin 3 to 5) ⁷⁾ , (max 400 μs if $V_{ON} > V_{ON(SC)}$)	$I_{L(SCp)}$				
$T_j = -40\text{ °C}$:		--	--	140	A
$T_j = 25\text{ °C}$:		--	95	--	
$T_j = +150\text{ °C}$:		45	--	--	
Repetitive short circuit current limit $T_j = T_{jt}$ (see timing diagrams, page 10)	$I_{L(SCr)}$	30	70	--	A
Short circuit shutdown delay after input pos. slope $V_{ON} > V_{ON(SC)}$, min value valid only, if input "low" time exceeds 30 μs	$t_{d(SC)}$	80	--	400	μs
Output clamp (inductive load switch off) at $V_{OUT} = V_{bb} - V_{ON(CL)}$, $I_L = 30\text{ mA}$	$V_{ON(CL)}$	--	58	--	V
Short circuit shutdown detection voltage (pin 3 to 5)	$V_{ON(SC)}$	--	8.3	--	V
Thermal overload trip temperature	T_{jt}	150	--	--	°C
Thermal hysteresis	ΔT_{jt}	--	10	--	K
Inductive load switch-off energy dissipation ⁸⁾ , $T_{j\text{ Start}} = 150\text{ °C}$, single pulse	E_{AS}	--	--	2.1	J
$V_{bb} = 12\text{ V}$:	E_{Load12}			1.7	
$V_{bb} = 24\text{ V}$:	E_{Load24}			1.2	
Reverse battery (pin 3 to 1) ⁹⁾	$-V_{bb}$	--	--	32	V
Integrated resistor in V_{bb} line	R_{bb}	--	120	--	Ω

Diagnostic Characteristics



Open load detection current (on-condition)	$T_j = -40\text{ °C}$: $T_j = 25..150\text{ °C}$:	$I_{L(OL)}$	2 2	-- --	1900 1500	mA
---	--	-------------	--------	----------	--------------	----

7) Short circuit current limit for max. duration of $t_{d(SC)} \text{ max} = 400\text{ }\mu\text{s}$, prior to shutdown

8) While demagnetizing load inductance, dissipated energy in PROFET is $E_{AS} = \int V_{ON(CL)} * i_L(t) dt$, approx.

$$E_{AS} = 1/2 * L * I_L^2 * \left(\frac{V_{ON(CL)}}{V_{ON(CL)} - V_{bb}} \right), \text{ see diagram page 8}$$

9) Reverse load current (through intrinsic drain-source diode) is normally limited by the connected load. Reverse current I_{GND} of $\approx 0.3\text{ A}$ at $V_{bb} = -32\text{ V}$ through the logic heats up the device. Time allowed under these condition is dependent on the size of the heatsink. Reverse I_{GND} can be reduced by an additional external GND-resistor (150 Ω). Input and Status currents have to be limited (see max. ratings page 2 and circuit page 7).

Parameter and Conditions at $T_j = 25\text{ °C}$, $V_{bb} = 12\text{ V}$ unless otherwise specified	Symbol	Values			Unit
		min	typ	max	
Input and Status Feedback¹⁰⁾					
Input turn-on threshold voltage  $T_j = -40..+150\text{ °C}$:	$V_{IN(T+)}$	1.5	--	2.4	V
Input turn-off threshold voltage  $T_j = -40..+150\text{ °C}$:	$V_{IN(T-)}$	1.0	--	--	V
Input threshold hysteresis	$\Delta V_{IN(T)}$	--	0.5	--	V
Off state input current (pin 2), $V_{IN} = 0.4\text{ V}$	$I_{IN(off)}$	1	--	30	μA
On state input current (pin 2), $V_{IN} = 3.5\text{ V}$	$I_{IN(on)}$	10	25	50	μA
Status invalid after positive input slope (short circuit) $T_j = -40 \dots +150\text{ °C}$:	$t_{d(ST\ SC)}$	80	200	400	μs
Status invalid after positive input slope (open load) $T_j = -40 \dots +150\text{ °C}$:	$t_{d(ST)}$	350	--	1600	μs
Status output (CMOS) $T_j = -40\dots+150\text{ °C}$, $I_{ST} = -50\ \mu\text{A}$:	$V_{ST(high)}^{11)}$	4.4	5.1	6.5	V
$T_j = -40\dots+150\text{ °C}$, $I_{ST} = +1.6\ \text{mA}$:	$V_{ST(low)}$	--	--	0.4	
Max. status current for valid status output, $T_j = -40\dots+150\text{ °C}$	current source (out): $-I_{ST}$	--	--	0.25	mA
	current sink (in) : $+I_{ST}^{12)}$	--	--	1.6	

¹⁰⁾ If a ground resistor R_{GND} is used, add the voltage drop across this resistor.

¹¹⁾ $V_{St\ high} \approx V_{bb}$ during undervoltage shutdown

¹²⁾ No current sink capability during undervoltage shutdown

Truth Table

	Input-level	Output level	Status	
			542 D2	542 E2
Normal operation	L	L	H	H
	H	H	H	H
Open load	L	¹³⁾	H	H
	H	H	L	L
Short circuit to GND	L	L	H	H
	H	L	L	L
Short circuit to V _{bb}	L	H	H	H
	H	H	H (L ¹⁴⁾)	H (L ¹⁴⁾)
Overtemperature	L	L	L	L
	H	L	L	L
Under-voltage	L	L	L ¹⁵⁾	H
	H	L	L ¹⁵⁾	H
Overvoltage	L	L	L	H
	H	L	L	H

L = "Low" Level

H = "High" Level

Terms

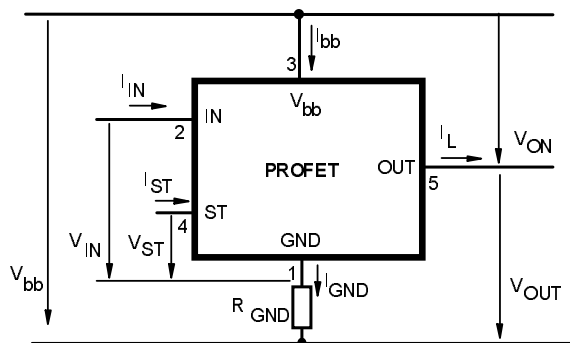

Input circuit (ESD protection)

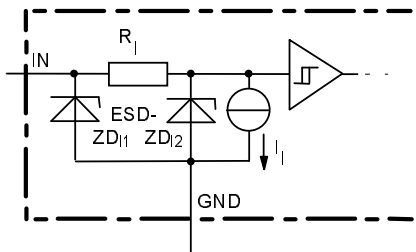

ZD₁ 6.1 V typ., ESD zener diodes are not to be used as voltage clamp at DC conditions. Operation in this mode may result in a drift of the zener voltage (increase of up to 1 V).

Status output

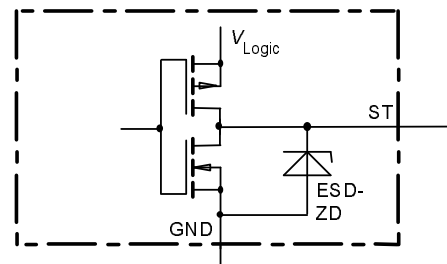

Zener diode: 6.1 V typ., max 5 mA, V_{Logic} 5 V typ, ESD zener diodes are not to be used as voltage clamp at DC conditions. Operation in this mode may result in a drift of the zener voltage (increase of up to 1 V).

Short Circuit detection

Fault Condition: V_{ON} > 8.3 V typ.; IN high

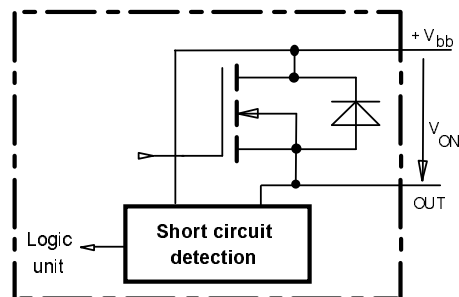

¹³⁾ Power Transistor off, high impedance

¹⁴⁾ Low resistance short V_{bb} to output may be detected by no-load-detection

¹⁵⁾ No current sink capability during undervoltage shutdown

Inductive and overvoltage output clamp

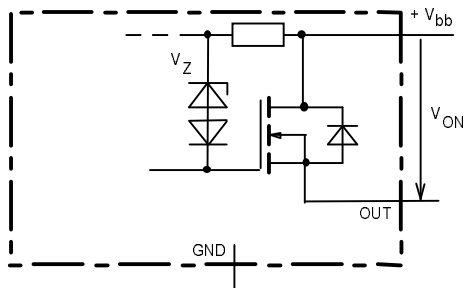

V_{ON} clamped to 58 V typ.

Overvolt. and reverse batt. protection

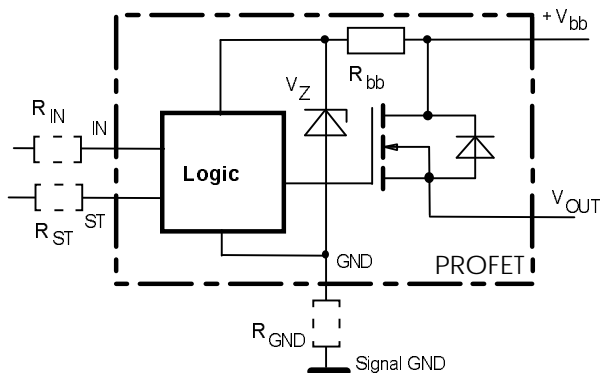

$R_{bb} = 120 \Omega$ typ., $V_z + R_{bb} * 40 \text{ mA} = 67 \text{ V}$ typ., add R_{GND} , R_{IN} , R_{ST} for extended protection

Open-load detection

ON-state diagnostic condition: $V_{ON} < R_{ON} * I_{L(OL)}$; IN high

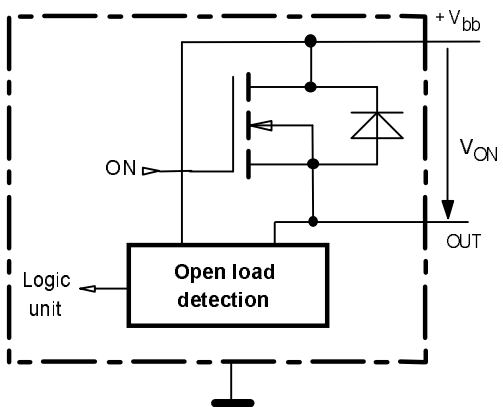

GND disconnect

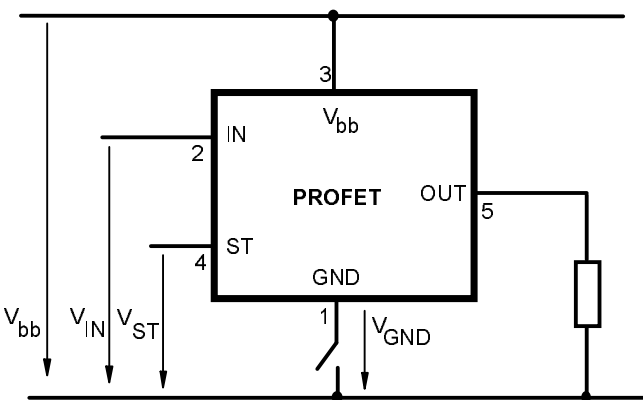

Any kind of load. In case of Input=high is $V_{OUT} \approx V_{IN} - V_{IN(T+)}$. Due to $V_{GND} > 0$, no $V_{ST} = \text{low}$ signal available.

GND disconnect with GND pull up

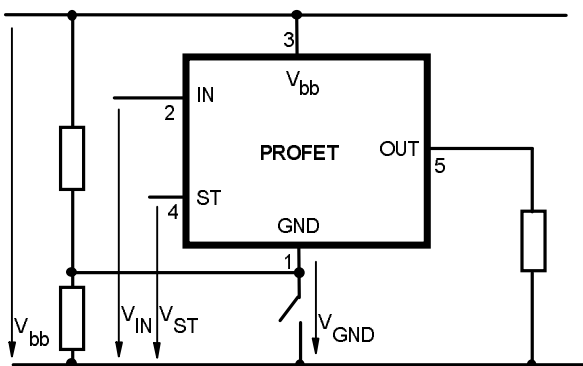

Any kind of load. If $V_{GND} > V_{IN} - V_{IN(T+)}$ device stays off. Due to $V_{GND} > 0$, no $V_{ST} = \text{low}$ signal available.

Vbb disconnect with charged inductive load

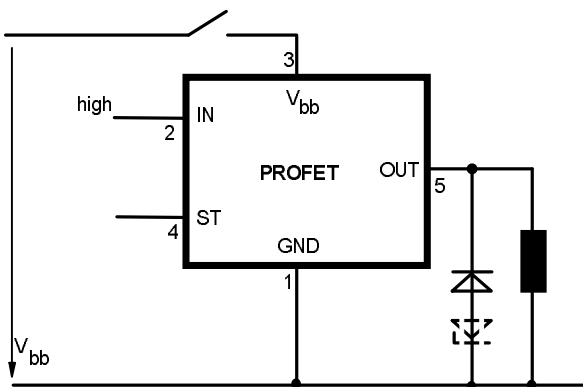

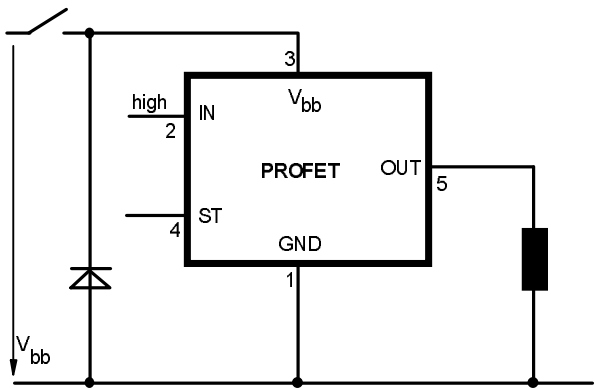

Inductive Load switch-off energy dissipation

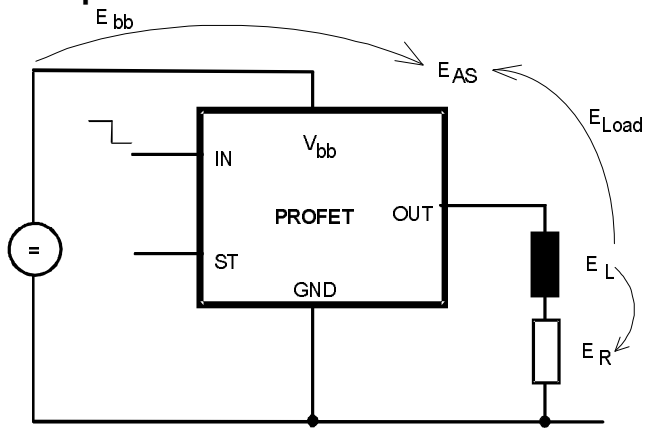

Energy dissipated in PROFET $E_{AS} = E_{bb} + E_L - E_R$.

$$E_{Load} < E_L, E_L = \frac{1}{2} * L * I_L^2$$

Options Overview

all versions: High-side switch, Input protection, ESD protection, load dump and reverse battery protection , protection against loss of ground

Type	BTS	542D2	542E2
Logic version		D	E
Overtemperature protection			
$T_j > 150\text{ °C}$, latch function ¹⁶⁾¹⁷⁾		X	
$T_j > 150\text{ °C}$, with auto-restart on cooling			X
Short-circuit to GND protection			
switches off when $V_{ON} > 8.3\text{ V}$ typ. ¹⁶⁾ (when first turned on after approx. 200 μs)		X	X
Open load detection			
in OFF-state with sensing current 30 μA typ. in ON-state with sensing voltage drop across power transistor		X	X
Undervoltage shutdown with auto restart		X	X
Overvoltage shutdown with auto restart		X	X
Status feedback for			
overtemperature		X	X
short circuit to GND		X	X
short to V_{bb}		.18)	.18)
open load		X	X
undervoltage		X	-
overvoltage		X	-
Status output type			
CMOS		X	
Open drain			X
Output negative voltage transient limit (fast inductive load switch off)			
to $V_{bb} - V_{ON(CL)}$		X	X
Load current limit			
high level (can handle loads with high inrush currents)		X	X
medium level			
low level (better protection of application)			

¹⁶⁾ Latch except when $V_{bb} - V_{OUT} < V_{ON(SC)}$ after shutdown. In most cases $V_{OUT} = 0\text{ V}$ after shutdown ($V_{OUT} \neq 0\text{ V}$ only if forced externally). So the device remains latched unless $V_{bb} < V_{ON(SC)}$ (see page 4). No latch between turn on and $t_{d(SC)}$.

¹⁷⁾ With latch function. Reset by a) Input low, b) Undervoltage, c) Overvoltage

¹⁸⁾ Low resistance short V_{bb} to output may be detected by no-load-detection

Timing diagrams

Figure 1a: V_{bb} turn on:

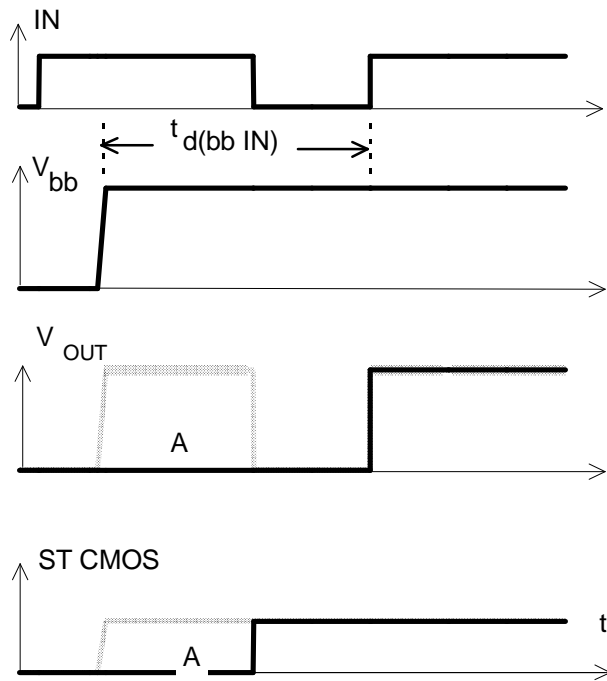

in case of too early V_{IN} =high the device may not turn on (curve A)
 $t_{d(bb IN)}$ approx. 150 μs

Figure 2a: Switching a lamp,

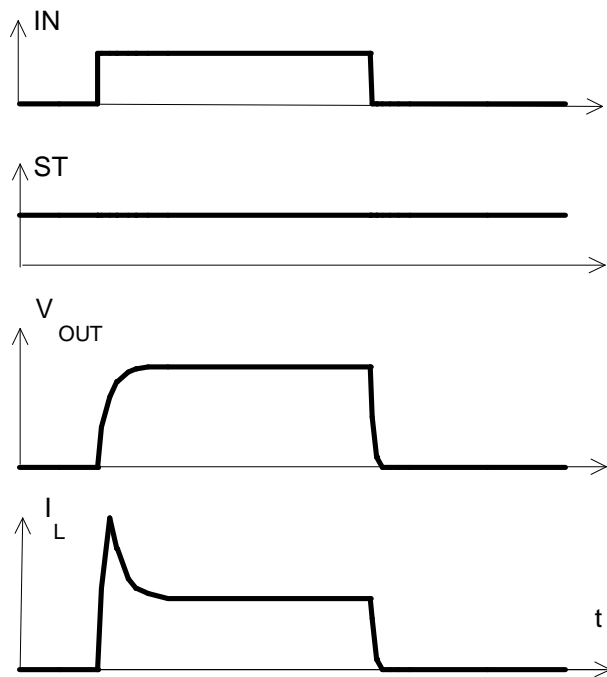
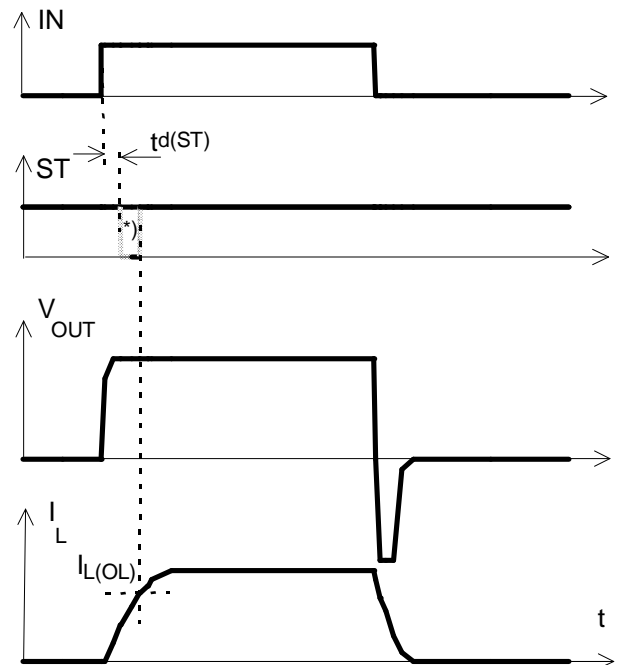
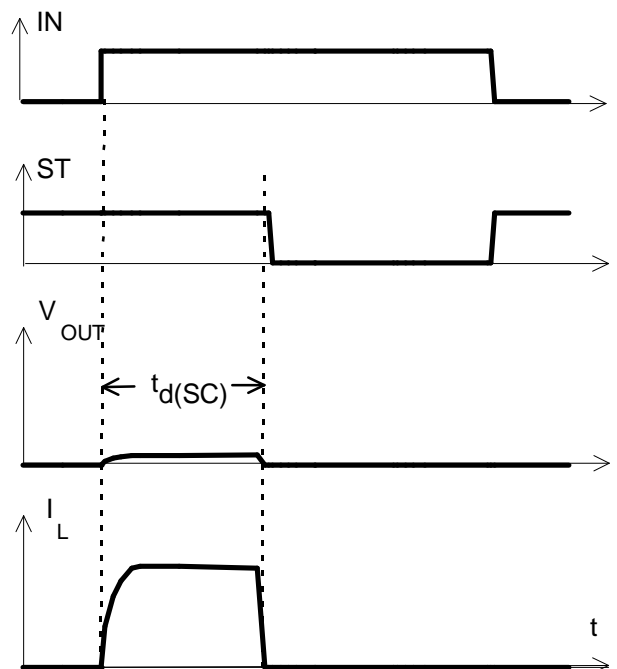

Figure 2b: Switching an inductive load



*) if the time constant of load is too large, open-load-status may occur

Figure 3a: Turn on into short circuit,



$t_{d(SC)}$ approx. 200 μs if $V_{bb} - V_{OUT} > 8.3 V$ typ.

Figure 3b: Turn on into overload,

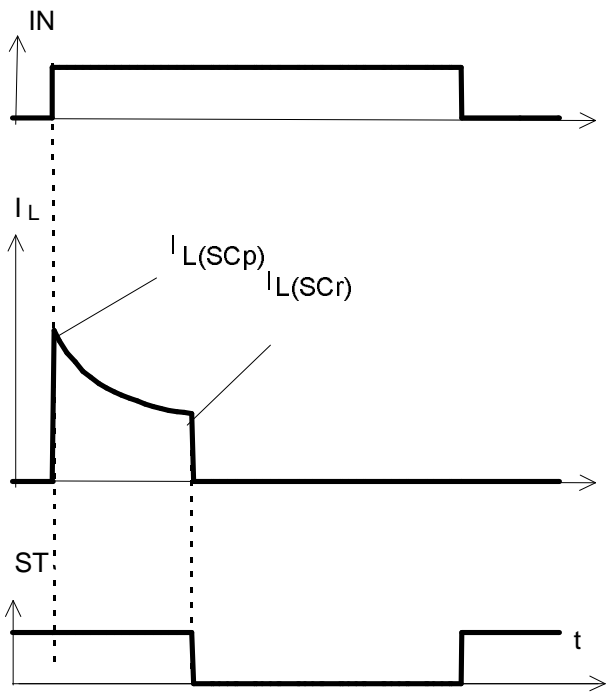

Heating up may require several milliseconds,
 $V_{bb} - V_{OUT} < 8.3 \text{ V typ.}$

$V_{bb} - V_{OUT} < 8.3 \text{ V typ.}$

Figure 3c: Short circuit while on:

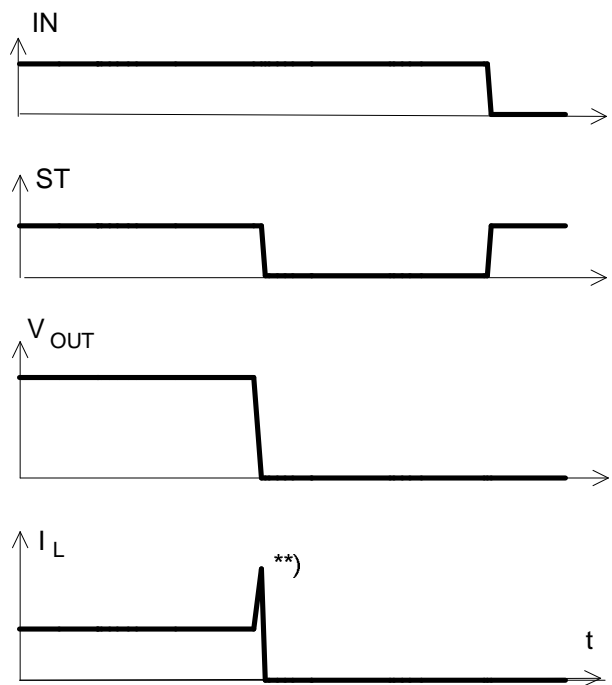

**) current peak approx. 20 μs

Figure 4a: Overtemperature,

Reset if ($I_N = \text{low}$) and ($T_j < T_{jt}$)

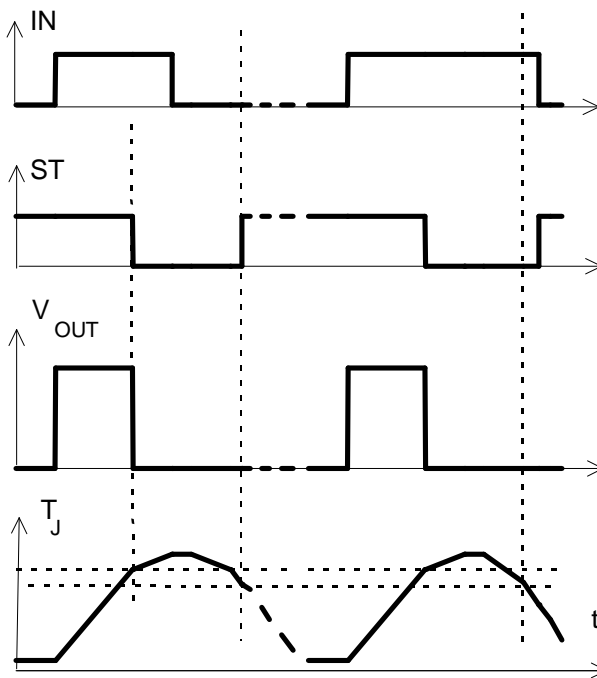

*) ST goes high, when $V_{IN} = \text{low}$ and $T_j < T_{jt}$

Figure 5a: Open load: detection in ON-state, turn on/off to open load

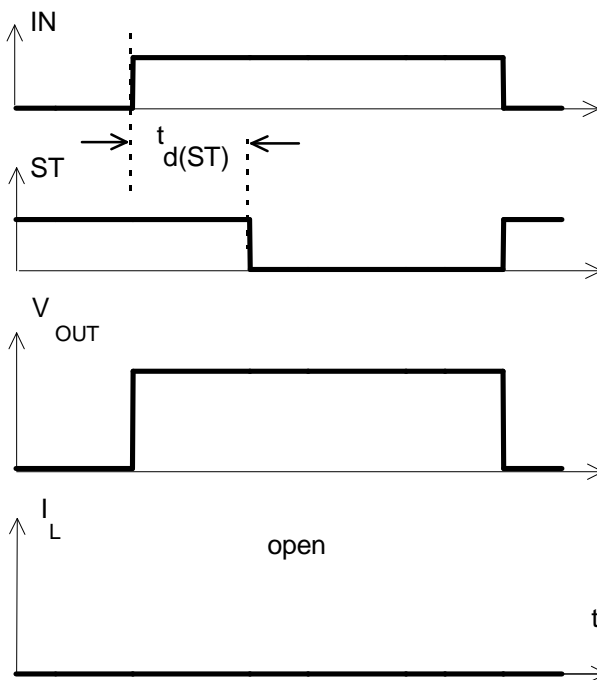

Figure 5b: Open load: detection in ON-state, open load occurs in on-state

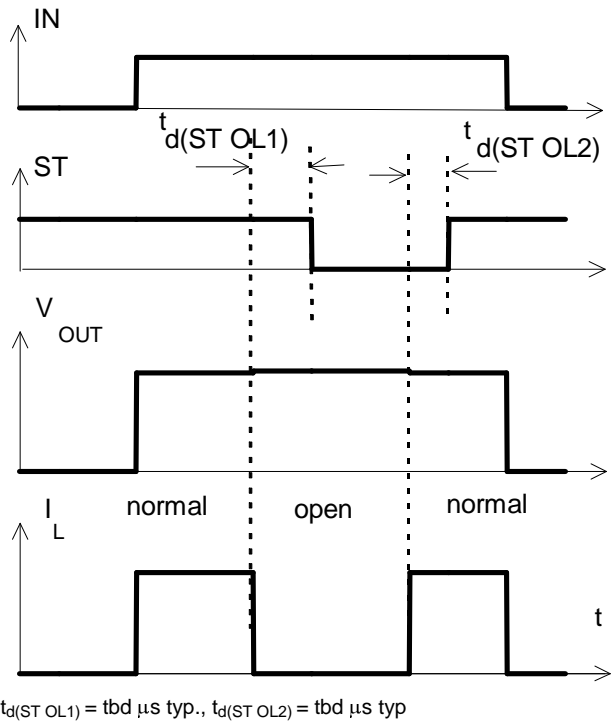

Figure 6a: Undervoltage:

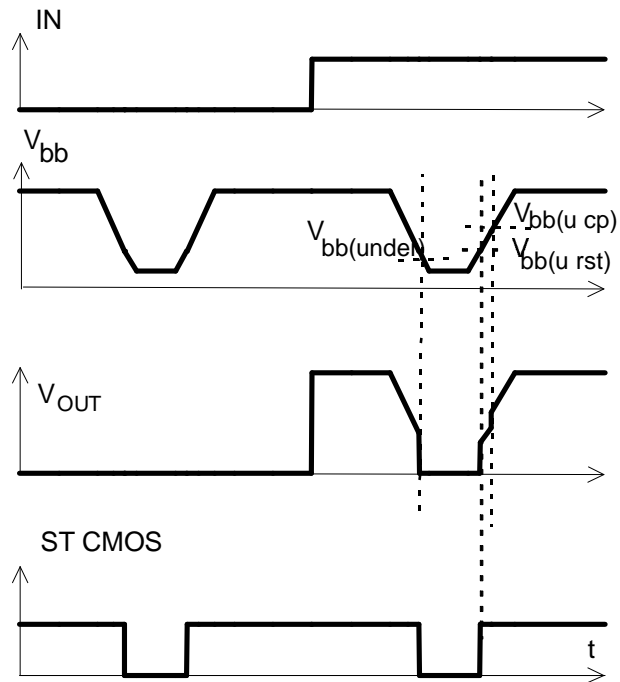

Figure 6b: Undervoltage restart of charge pump

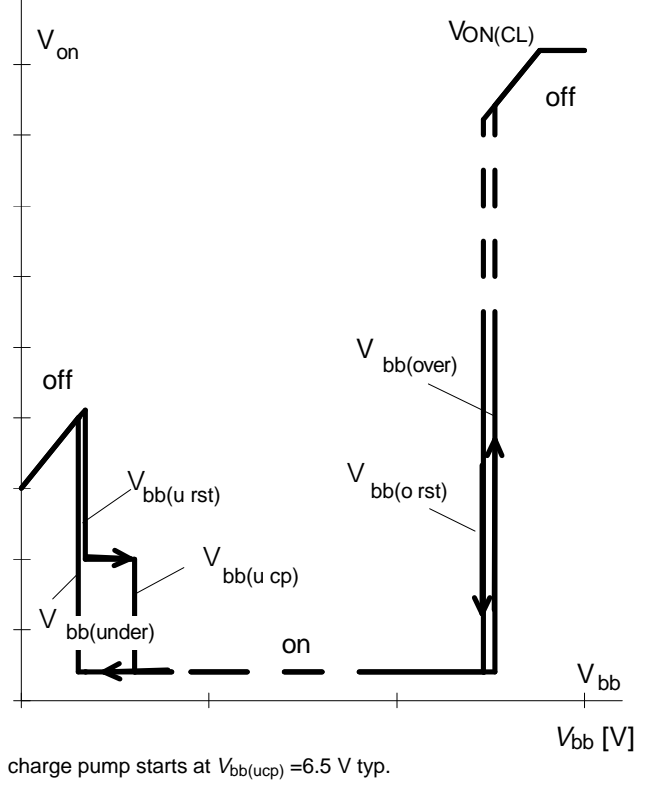
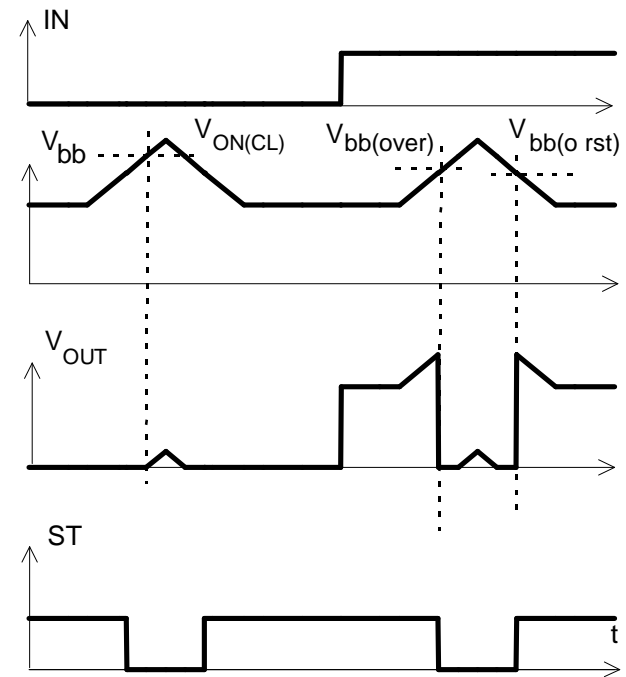

Figure 7a: Overvoltage:



Package and Ordering Code

All dimensions in mm

Standard TO-218AB/5

Ordering code

BTS 542 D2

Q67060-S6950-A2

