

## Smart Highside Power Switch TEMPFET®

**BTS 100**

### Features

- P channel
- Enhancement mode
- Temperature sensor with thyristor characteristic
- The drain pin is electrically shorted to the tab

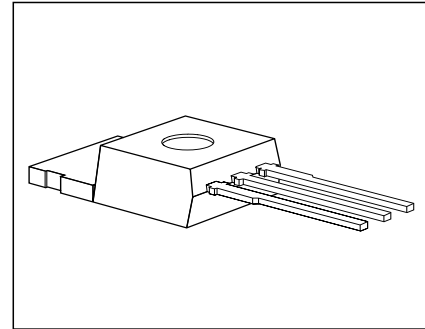

Pin	1	2	3
	G	D	S

Type	$V_{DS}$	$I_D$	$R_{DS(on)}$	Package	Ordering Code
BTS 100	- 50 V	- 8 A	0.3 $\Omega$	TO-220AB	C67078-A5007-A2

### Maximum Ratings

Parameter	Symbol	Values	Unit
Drain-source voltage	$V_{DS}$	- 50	V
Drain-gate voltage, $R_{GS} = 20 \text{ k}\Omega$	$V_{DGR}$	- 50	
Gate-source voltage	$V_{GS}$	$\pm 20$	
Continuous drain current, $T_C = 30 \text{ }^\circ\text{C}$	$I_D$	- 8.0	A
ISO drain current $T_C = 85 \text{ }^\circ\text{C}$ , $V_{GS} = 10 \text{ V}$ , $V_{DS} = 0.5 \text{ V}$	$I_{D-ISO}$	- 1.5	
Pulsed drain current, $T_C = 25 \text{ }^\circ\text{C}$	$I_{D \text{ puls}}$	- 32	
Short circuit current, $T_j = - 55 \dots + 150 \text{ }^\circ\text{C}$	$I_{SC}$	- 25	
Short circuit dissipation, $T_j = - 55 \dots + 150 \text{ }^\circ\text{C}$	$P_{SCmax}$	500	W
Power dissipation	$P_{tot}$	40	
Operating and storage temperature range	$T_j, T_{stg}$	- 55 ... + 150	$^\circ\text{C}$
DIN humidity category, DIN 40 040	-	E	-
IEC climatic category, DIN IEC 68-1	-	55/150/56	
Thermal resistance Chip-case Chip-ambient	$R_{th \text{ JC}}$ $R_{th \text{ JA}}$	$\leq 3.1$ $\leq 75$	K/W

## Electrical Characteristics

at  $T_j = 25\text{ °C}$ , unless otherwise specified.

Parameter	Symbol	Values			Unit
		min.	typ.	max.	

## Static Characteristics

Drain-source breakdown voltage $V_{GS} = 0, I_D = -0.25\text{ mA}$	$V_{(BR)DSS}$	- 50	-	-	V
Gate threshold voltage $V_{GS} = V_{DS}, I_D = -1\text{ mA}$	$V_{GS(th)}$	- 2.5	- 3.0	- 3.5	
Zero gate voltage drain current $V_{GS} = 0\text{ V}, V_{DS} = -50\text{ V}$ $T_j = 25\text{ °C}$ $T_j = 150\text{ °C}$	$I_{DSS}$	-	- 1 - 100	- 10 - 300	$\mu\text{A}$
Gate-source leakage current $V_{GS} = -20\text{ V}, V_{DS} = 0$ $T_j = 25\text{ °C}$ $T_j = 150\text{ °C}$	$I_{GSS}$	-	- 10 - 2	- 100 - 4	nA $\mu\text{A}$
Drain-source on-state resistance $V_{GS} = -10\text{ V}, I_D = -5\text{ A}$	$R_{DS(on)}$	-	0.25	0.3	$\Omega$

## Dynamic Characteristics

Forward transconductance $V_{DS} \geq 2 \times I_D \times R_{DS(on)max}, I_D = -5\text{ A}$	$g_{fs}$	1.5	2.3	4.0	S
Input capacitance $V_{GS} = 0, V_{DS} = -25\text{ V}, f = 1\text{ MHz}$	$C_{iss}$	-	900	1200	pF
Output capacitance $V_{GS} = 0, V_{DS} = -25\text{ V}, f = 1\text{ MHz}$	$C_{oss}$	-	350	550	
Reverse transfer capacitance $V_{GS} = 0, V_{DS} = -25\text{ V}, f = 1\text{ MHz}$	$C_{rss}$	-	130	230	
Turn-on time $t_{on}$ , ( $t_{on} = t_{d(on)} + t_r$ ) $V_{CC} = -30\text{ V}, V_{GS} = -10\text{ V}, I_D = -2.9\text{ A},$ $R_{GS} = 50\text{ }\Omega$	$t_{d(on)}$	-	20	30	ns
	$t_r$	-	60	95	
Turn-off time $t_{off}$ , ( $t_{off} = t_{d(off)} + t_f$ ) $V_{CC} = -30\text{ V}, V_{GS} = -10\text{ V}, I_D = -2.9\text{ A},$ $R_{GS} = 50\text{ }\Omega$	$t_{d(off)}$	-	70	90	
	$t_f$	-	55	75	

## Electrical Characteristics (cont'd)

at  $T_j = 25\text{ °C}$ , unless otherwise specified.

Parameter	Symbol	Values			Unit
		min.	typ.	max.	

### Reverse Diode

Continuous source current	$I_S$	–	–	– 8.0	A
Pulsed source current	$I_{SM}$	–	–	– 32	
Diode forward on-voltage $I_F = -16\text{ A}$ , $V_{GS} = 0$	$V_{SD}$	–	– 1.0	– 1.7	V
Reverse recovery time $I_F = I_S$ , $di_F/dt = -100\text{ A}/\mu\text{s}$ , $V_R = -30\text{ V}$	$t_{rr}$	–	90	–	ns
Reverse recovery charge $I_F = I_S$ , $di_F/dt = -100\text{ A}/\mu\text{s}$ , $V_R = -30\text{ V}$	$Q_{rr}$	–	0.23	–	$\mu\text{C}$

### Temperature Sensor

Forward voltage $I_{TS(on)} = -10\text{ mA}$ , $T_j = -55 \dots +150\text{ °C}$ Sensor override, $t_p \leq 100\text{ }\mu\text{s}$ $T_j = -55 \dots +160\text{ °C}$	$V_{TS(on)}$	–	– 1.4	– 1.5	V
Forward current $T_j = -55 \dots +150\text{ °C}$ Sensor override, $t_p \leq 100\text{ }\mu\text{s}$ $T_j = -55 \dots +160\text{ °C}$	$I_{TS(on)}$	–	–	– 10	
Holding current, $V_{TS(off)} = -5\text{ V}$ , $T_j = 25\text{ °C}$ $T_j = 150\text{ °C}$	$I_H$	– 0.05 – 0.05	– 0.1 – 0.2	– 0.5 – 0.3	mA
Switching temperature $V_{TS} = -5\text{ V}$	$T_{TS(on)}$	150	–	–	
Turn-off time $V_{TS} = -5\text{ V}$ , $I_{TS(on)} = -2\text{ mA}$	$t_{off}$	0.5	–	2.5	$\mu\text{s}$

### Examples for short-circuit protection

at  $T_j = -55 \dots +150 \text{ }^\circ\text{C}$ , unless otherwise specified.

Parameter	Symbol	Example			Unit
		1	2	–	
Drain-source voltage	$V_{DS}$	– 15	– 30	–	V
Gate-source voltage	$V_{GS}$	– 10	– 8.2	–	
Short-circuit current	$I_{SC}$	$\leq -25$	$\leq -16$	–	A
Short-circuit dissipation	$P_{SC}$	375	480	–	W
Response time $T_j = 25 \text{ }^\circ\text{C}$ , before short circuit	$t_{SC(off)}$	55	55	–	ms

### Short-circuit protection $I_{SC} = f(V_{DS})$

Parameter:  $V_{GS}$

Diagram to determine  $I_{SC}$  for  $T_j = -55 \dots +150 \text{ }^\circ\text{C}$

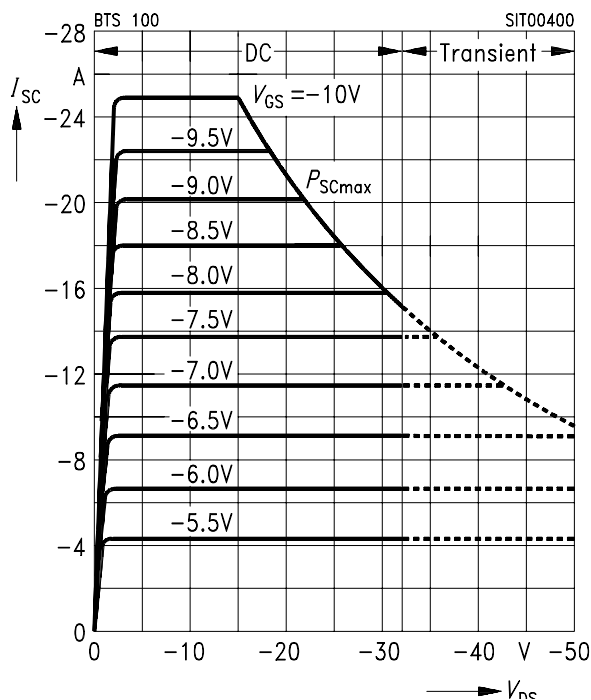

### Max. gate voltage $V_{GS(SC)} = f(V_{DS})$

Parameter:  $T_j = -55 \dots +150 \text{ }^\circ\text{C}$

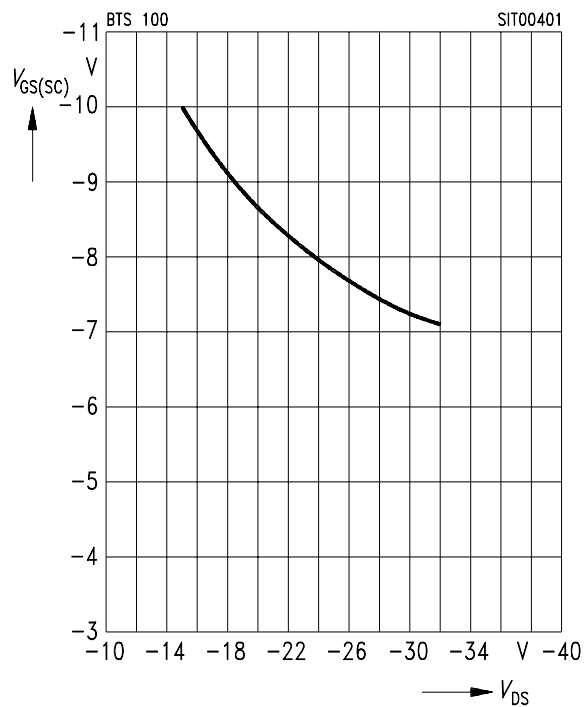

**Max. power dissipation  $P_{tot} = f(T_C)$**

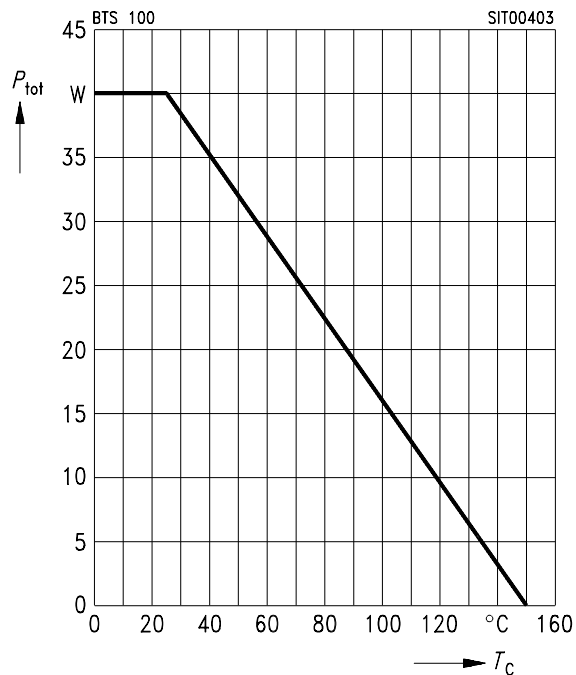

**Typ. drain-source on-state resistance  $R_{DS(on)} = f(I_D)$**

Parameter:  $V_{GS}$

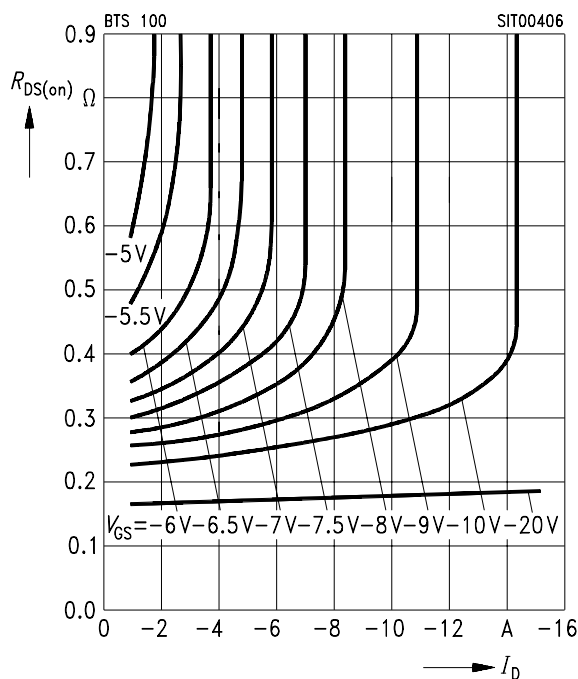

**Typical output characteristics  $I_D = f(V_{DS})$**

Parameter:  $t_p = 80 \mu s$

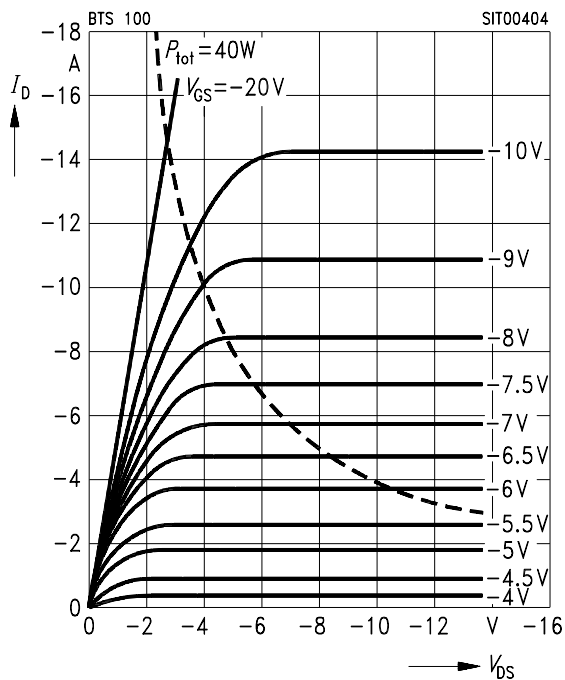

**Safe operating area  $I_D = f(V_{DS})$**

Parameter:  $D = 0.01$ ,  $T_C = 25^\circ C$

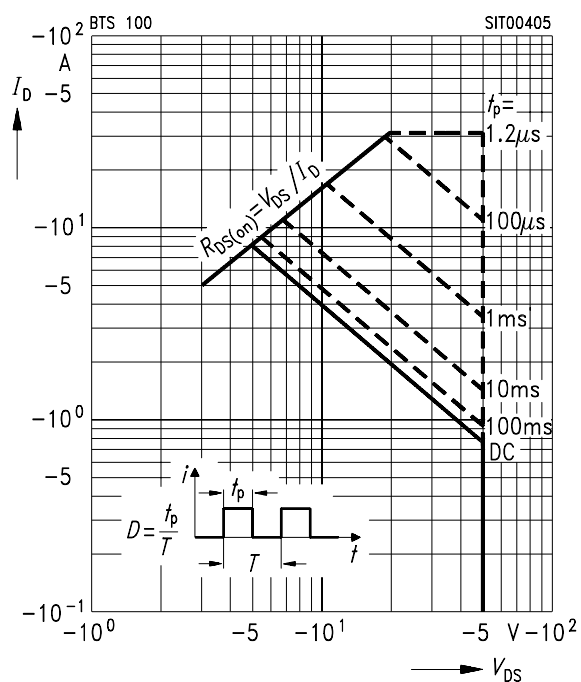

**Drain-source on-state resistance**

$R_{DS(on)} = f(T_j)$

Parameter:  $I_D = -5\text{ A}$ ,  $V_{GS} = -10\text{ V}$

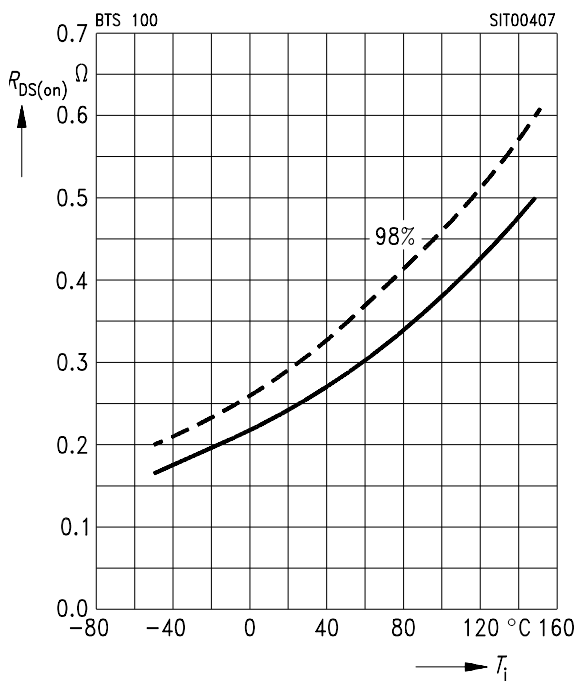

**Gate threshold voltage  $V_{GS(th)} = f(T_j)$**

Parameter:  $V_{DS} = V_{GS}$ ,  $I_D = -1\text{ mA}$

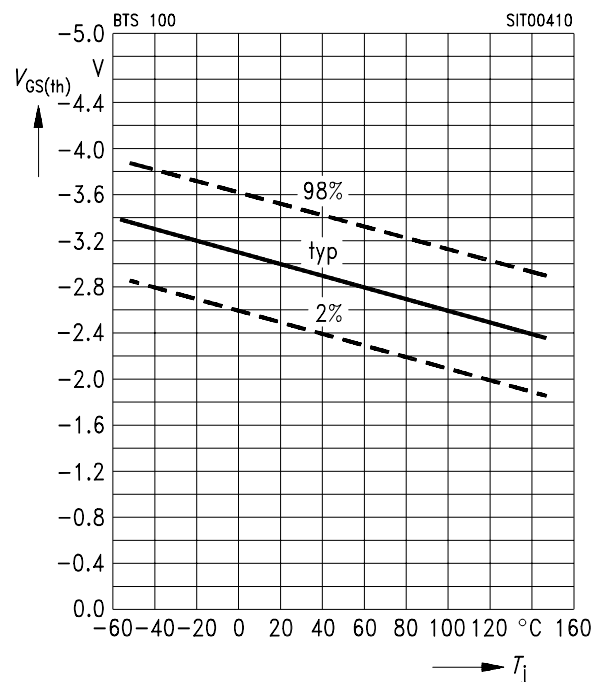

**Typ. transfer characteristic**

$I_D = f(V_{GS})$

Parameter:  $t_p = 80\ \mu\text{s}$ ,  $V_{DS} = -25\text{ V}$

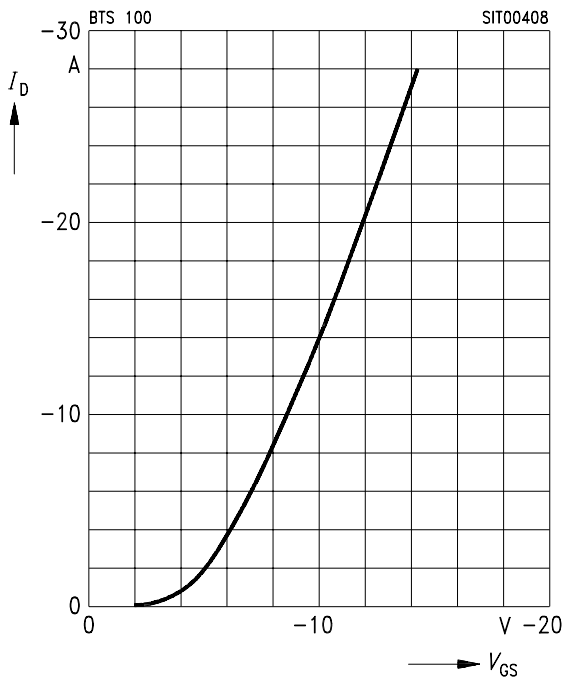

**Typ. transconductance  $g_{fs} = f(I_D)$**

Parameter:  $t_p = 80\ \mu\text{s}$ ,  $V_{DS} = -25\text{ V}$

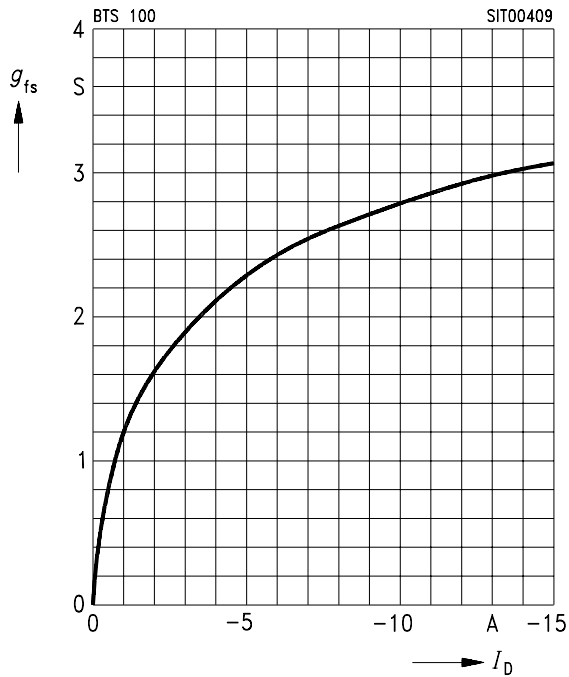

**Continuous drain current  $I_D = f(T_C)$**

Parameter:  $V_{GS} \geq -10$  V

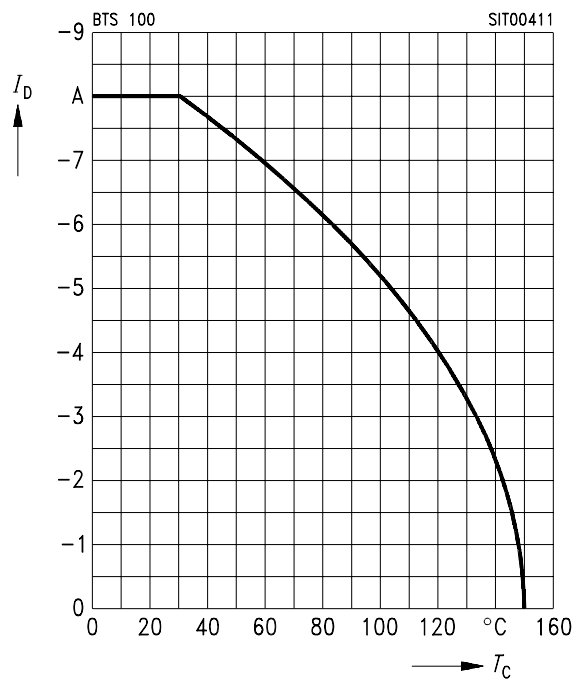

**Forward characteristics of reverse diode  $I_F = f(V_{SD})$**

Parameter:  $T_j, t_p = 80 \mu s$

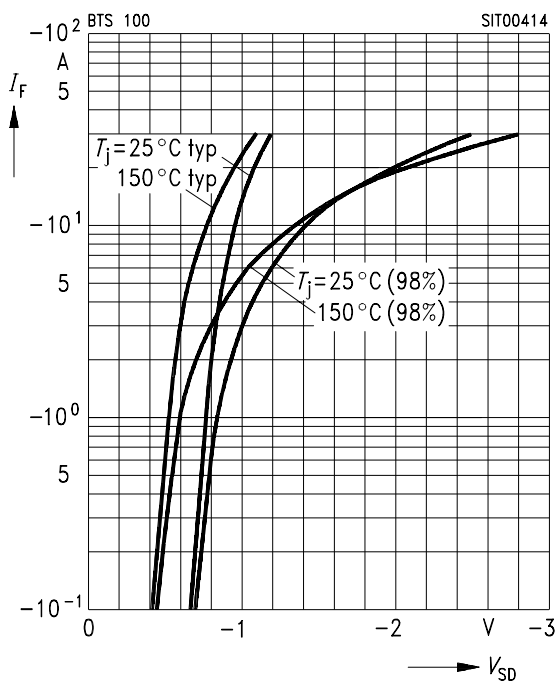

**Typ. gate-source leakage current  $I_{GSS} = f(T_C)$**

Parameter:  $V_{GS} = -20$  V,  $V_{DS} = 0$

Parameter:  $V_{GS} = -20$  V,  $V_{DS} = 0$

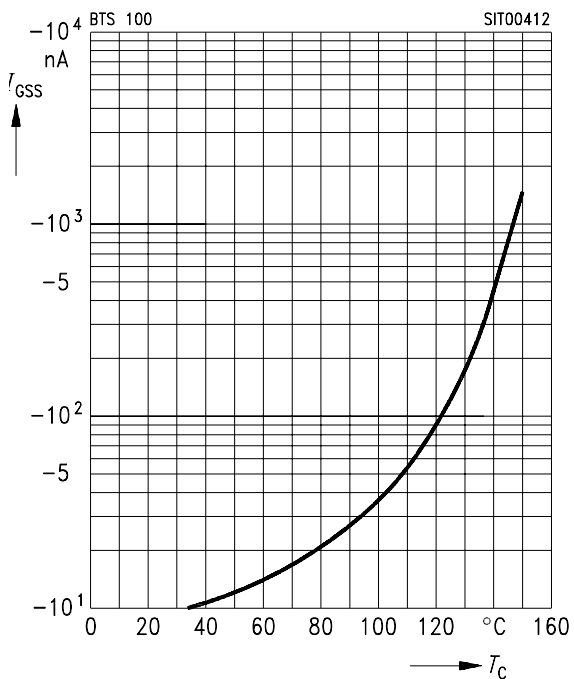

**Typ. capacitances  $C = f(V_{DS})$**

Parameter:  $V_{GS} = 0$ ,  $f = 1$  MHz

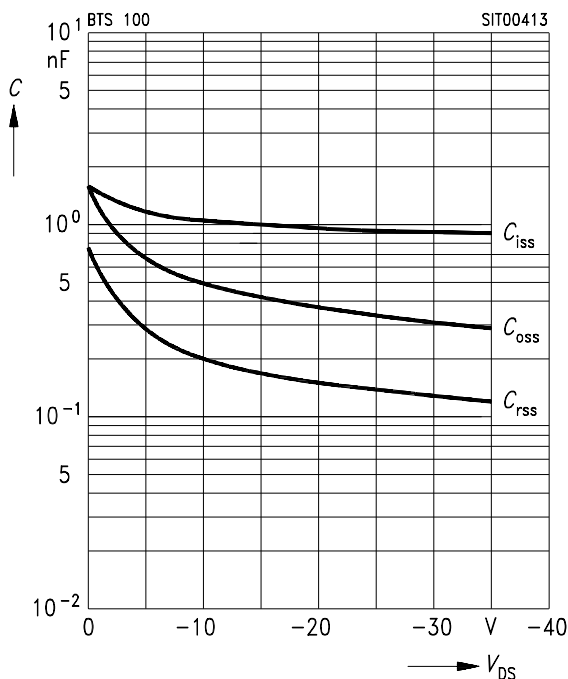

## Transient thermal impedance $Z_{thJC} = f(t_p)$

Parameter:  $D = t_p/T$

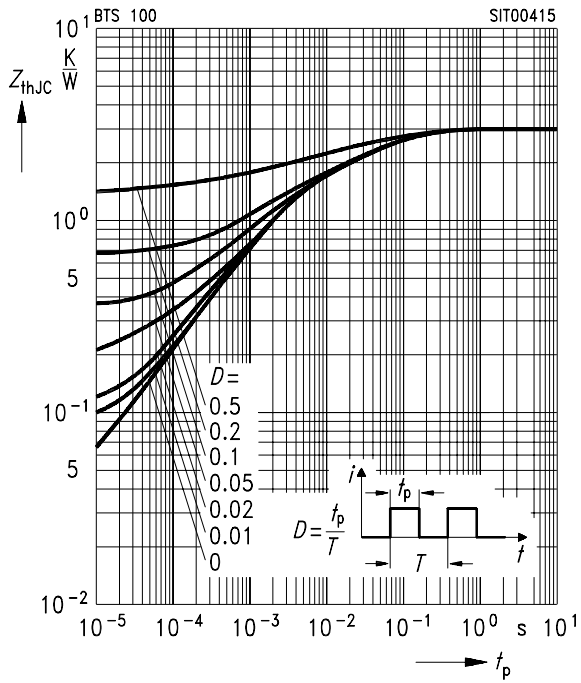



**TO 220 AB**  
Standard

**Ordering Code**  
C67078-A5007-A2

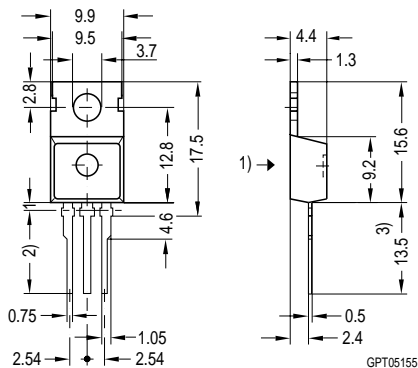

- 1) punch direction, burr max. 0.04
- 2) dip tinning
- 3) max. 14.5 by dip tinning press burr max. 0.05

**TO 220 AB**  
SMD Version E3045  
SMD T&R E3045A

**Ordering Code**  
C67078-A5007-A7  
C67078-A5007-A12

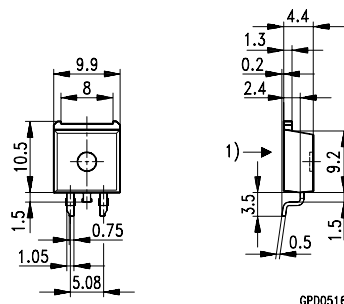

- 1) shear and punch direction no burrs this surface