

3.3V Zero Delay Buffer

Features

- Zero input-output propagation delay, adjustable by capacitive load on FBK input
- Multiple configurations, see “Available CY2308 Configurations” table
- Multiple low-skew outputs
 - Output-output skew less than 200 ps
 - Device-device skew less than 700 ps
 - Two banks of four outputs, three-stateable by two select inputs
- 10-MHz to 133-MHz operating range
- Low jitter, less than 200 ps cycle-cycle (-1, -1H, -4, -5H)
- Space-saving 16-pin 150-mil SOIC package or 16-pin TSSOP
- 3.3V operation
- Industrial Temperature available

Functional Description

The CY2308 is a 3.3V Zero Delay Buffer designed to distribute high-speed clocks in PC, workstation, datacom, telecom, and other high-performance applications.

The part has an on-chip PLL which locks to an input clock presented on the REF pin. The PLL feedback is required to be driven into the FBK pin, and can be obtained from one of the outputs. The input-to-output skew is guaranteed to be less than 350 ps, and output-to-output skew is guaranteed to be less than 200 ps.

The CY2308 has two banks of four outputs each, which can be controlled by the Select inputs as shown in the table “Select Input Decoding.” If all output clocks are not required, Bank B can be three-stated. The select inputs also allow the input clock to be directly applied to the output for chip and system testing purposes.

The CY2308 PLL enters a power-down state when there are no rising edges on the REF input. In this mode, all outputs are three-stated and the PLL is turned off, resulting in less than 50 μ A of current draw. The PLL shuts down in two additional cases as shown in the “Select Input Decoding” table.

Multiple CY2308 devices can accept the same input clock and distribute it in a system. In this case, the skew between the outputs of two devices is guaranteed to be less than 700 ps.

The CY2308 is available in five different configurations, as shown in the “Available CY2308 Configurations” table on page 2. The CY2308-1 is the base part, where the output frequencies equal the reference if there is no counter in the feedback path. The CY2308-1H is the high-drive version of the -1, and rise and fall times on this device are much faster.

The CY2308-2 allows the user to obtain 2X and 1X frequencies on each output bank. The exact configuration and output frequencies depends on which output drives the feedback pin. The CY2308-3 allows the user to obtain 4X and 2X frequencies on the outputs.

The CY2308-4 enables the user to obtain 2X clocks on all outputs. Thus, the part is extremely versatile, and can be used in a variety of applications.

The CY2308-5H is a high-drive version with REF/2 on both banks.

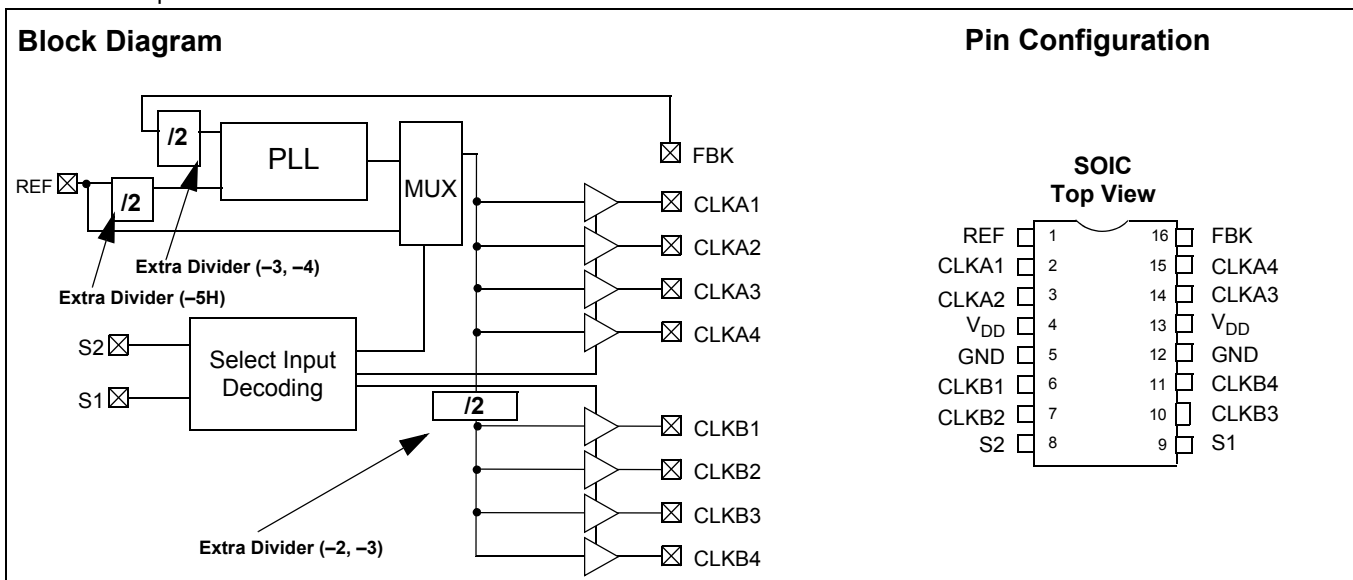

Pin Description

Pin	Signal	Description
1	REF ^[1]	Input reference frequency, 5V tolerant input
2	CLKA1 ^[2]	Clock output, Bank A
3	CLKA2 ^[2]	Clock output, Bank A
4	V _{DD}	3.3V supply
5	GND	Ground
6	CLKB1 ^[2]	Clock output, Bank B
7	CLKB2 ^[2]	Clock output, Bank B
8	S2 ^[3]	Select input, bit 2
9	S1 ^[3]	Select input, bit 1
10	CLKB3 ^[2]	Clock output, Bank B
11	CLKB4 ^[2]	Clock output, Bank B
12	GND	Ground
13	V _{DD}	3.3V supply
14	CLKA3 ^[2]	Clock output, Bank A
15	CLKA4 ^[2]	Clock output, Bank A
16	FBK	PLL feedback input

Select Input Decoding

S2	S1	CLOCK A1–A4	CLOCK B1–B4	Output Source	PLL Shutdown
0	0	Three-State	Three-State	PLL	Y
0	1	Driven	Three-State	PLL	N
1	0	Driven ^[4]	Driven ^[4]	Reference	Y
1	1	Driven	Driven	PLL	N

Available CY2308 Configurations

Device	Feedback From	Bank A Frequency	Bank B Frequency
CY2308–1	Bank A or Bank B	Reference	Reference
CY2308–1H	Bank A or Bank B	Reference	Reference
CY2308–2	Bank A	Reference	Reference/2
CY2308–2	Bank B	2 X Reference	Reference
CY2308–3	Bank A	2 X Reference	Reference or Reference ^[5]
CY2308–3	Bank B	4 X Reference	2 X Reference
CY2308–4	Bank A or Bank B	2 X Reference	2 X Reference
CY2308–5H	Bank A or Bank B	Reference /2	Reference /2

Notes:

1. Weak pull-down.
2. Weak pull-down on all outputs.
3. Weak pull-ups on these inputs.
4. Outputs inverted on 2308–2 and 2308–3 in bypass mode, S2 = 1 and S1 = 0.
5. Output phase is indeterminate (0° or 180° from input clock). If phase integrity is required, use the CY2308–2.

Zero Delay and Skew Control

REF. Input to CLKA/CLKB Delay v/s Difference in Loading between FBK pin and CLKA/CLKB Pins

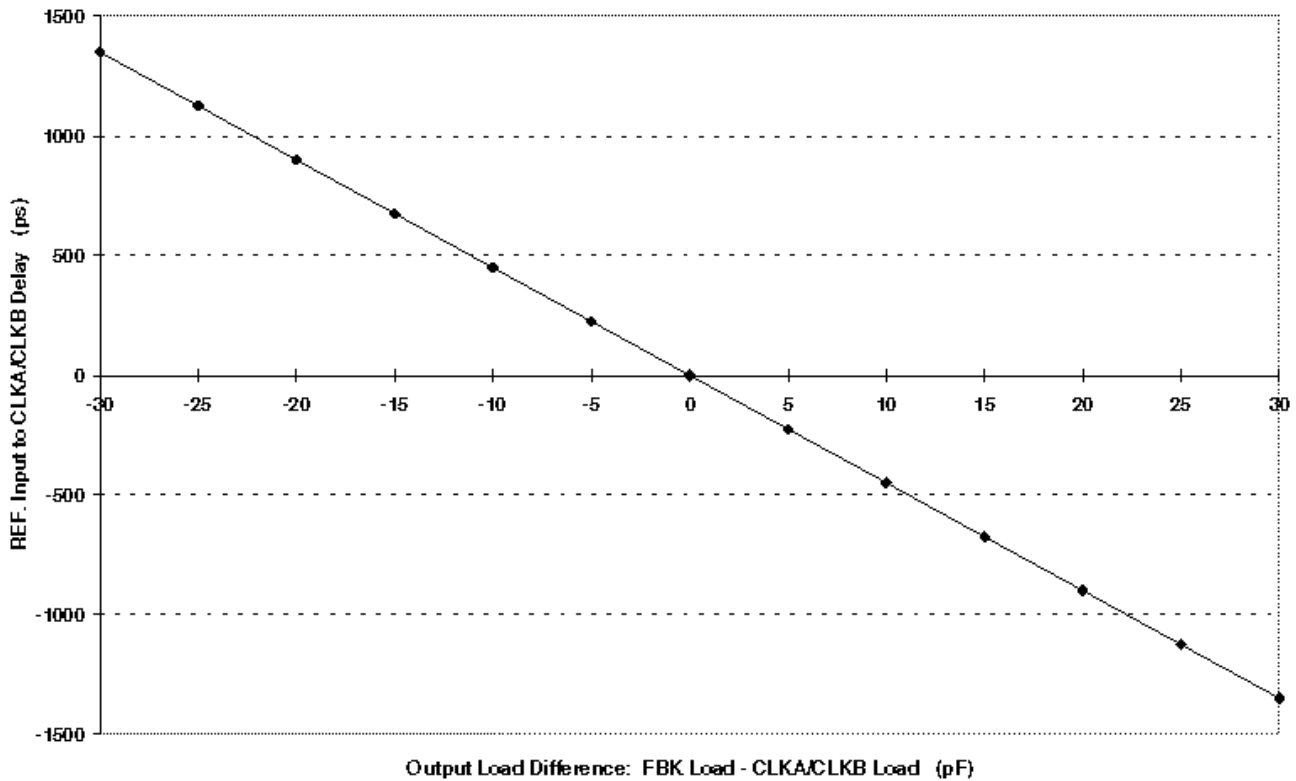

To close the feedback loop of the CY2308, the FBK pin can be driven from any of the eight available output pins. The output driving the FBK pin will be driving a total load of 7 pF plus any additional load that it drives. The relative loading of this output (with respect to the remaining outputs) can adjust the input-output delay. This is shown in the graph above.

For applications requiring zero input-output delay, all outputs including the one providing feedback should be equally loaded. If input-output delay adjustments are required, use the above graph to calculate loading differences between the feedback output and remaining outputs.

For zero output-output skew, be sure to load outputs equally. For further information on using CY2308, refer to the application note "CY2308: Zero Delay Buffer."

Maximum Ratings

Supply Voltage to Ground Potential	-0.5V to +7.0V
DC Input Voltage (Except Ref)	-0.5V to $V_{DD} + 0.5V$
DC Input Voltage REF	-0.5 to 7V
Storage Temperature	-65°C to +150°C
Junction Temperature	150°C
Static Discharge Voltage (per MIL-STD-883, Method 3015)	>2000V

Operating Conditions for CY2308SC-XX Commercial Temperature Devices

Parameter	Description	Min.	Max.	Unit
V_{DD}	Supply Voltage	3.0	3.6	V
T_A	Operating Temperature (Ambient Temperature)	0	70	°C
C_L	Load Capacitance, below 100 MHz		30	pF
	Load Capacitance, from 100 MHz to 133 MHz		15	pF
C_{IN}	Input Capacitance ^[6]		7	pF
t_{PU}	Power-up time for all V_{DD} s to reach minimum specified voltage (power ramps must be monotonic)	0.05	50	ms

Note:

6. Applies to both Ref Clock and FBK.

Electrical Characteristics for CY2308SC-XX Commercial Temperature Devices

Parameter	Description	Test Conditions	Min.	Max.	Unit
V_{IL}	Input LOW Voltage			0.8	V
V_{IH}	Input HIGH Voltage		2.0		V
I_{IL}	Input LOW Current	$V_{IN} = 0V$		50.0	μA
I_{IH}	Input HIGH Current	$V_{IN} = V_{DD}$		100.0	μA
V_{OL}	Output LOW Voltage ^[7]	$I_{OL} = 8\text{ mA} (-1, -2, -3, -4)$ $I_{OL} = 12\text{ mA} (-1H, -5H)$		0.4	V
V_{OH}	Output HIGH Voltage ^[7]	$I_{OH} = -8\text{ mA} (-1, -2, -3, -4)$ $I_{OH} = -12\text{ mA} (-1H, -5H)$	2.4		V
I_{DD} (PD mode)	Power Down Supply Current	REF = 0 MHz		12.0	μA
I_{DD}	Supply Current	Unloaded outputs, 100-MHz REF, Select inputs at V_{DD} or GND		45.0	mA
				70.0 (-1H,-5H)	mA
		Unloaded outputs, 66-MHz REF (-1, -2, -3, -4)		32.0	mA
	Unloaded outputs, 33-MHz REF (-1, -2, -3, -4)		18.0	mA	

Note:

7. Parameter is guaranteed by design and characterization. Not 100% tested in production.

Switching Characteristics for CY2308SC-XX Commercial Temperature Devices ^[8]

Parameter	Name	Test Conditions	Min.	Typ.	Max.	Unit
t ₁	Output Frequency	30-pF load, All devices	10		100	MHz
t ₁	Output Frequency	20-pF load, -1H, -5H devices ^[9]	10		133.3	MHz
t ₁	Output Frequency	15-pF load, -1, -2, -3, -4 devices	10		133.3	MHz
	Duty Cycle ^[7] = t ₂ ÷ t ₁ (-1, -2, -3, -4, -1H, -5H)	Measured at 1.4V, F _{OUT} = 66.66 MHz 30-pF load	40.0	50.0	60.0	%
	Duty Cycle ^[7] = t ₂ ÷ t ₁ (-1, -2, -3, -4, -1H, -5H)	Measured at 1.4V, F _{OUT} <50.0 MHz 15-pF load	45.0	50.0	55.0	%
t ₃	Rise Time ^[7] (-1, -2, -3, -4)	Measured between 0.8V and 2.0V, 30-pF load			2.20	ns
t ₃	Rise Time ^[7] (-1, -2, -3, -4)	Measured between 0.8V and 2.0V, 15-pF load			1.50	ns
t ₃	Rise Time ^[7] (-1H, -5H)	Measured between 0.8V and 2.0V, 30-pF load			1.50	ns
t ₄	Fall Time ^[7] (-1, -2, -3, -4)	Measured between 0.8V and 2.0V, 30-pF load			2.20	ns
t ₄	Fall Time ^[7] (-1, -2, -3, -4)	Measured between 0.8V and 2.0V, 15-pF load			1.50	ns
t ₄	Fall Time ^[7] (-1H, -5H)	Measured between 0.8V and 2.0V, 30-pF load			1.25	ns
t ₅	Output to Output Skew on same Bank (-1, -2, -3, -4) ^[7]	All outputs equally loaded			200	ps
	Output to Output Skew (-1H, -5H)	All outputs equally loaded			200	ps
	Output Bank A to Output Bank B Skew (-1, -4, -5H)	All outputs equally loaded			200	ps
	Output Bank A to Output Bank B Skew (-2, -3)	All outputs equally loaded			400	ps
t ₆	Delay, REF Rising Edge to FBK Rising Edge ^[7]	Measured at V _{DD} /2		0	±250	ps
t ₇	Device to Device Skew ^[7]	Measured at V _{DD} /2 on the FBK pins of devices		0	700	ps
t ₈	Output Slew Rate ^[7]	Measured between 0.8V and 2.0V on -1H, -5H device using Test Circuit #2	1			V/ns
t _J	Cycle to Cycle Jitter ^[7] (-1, -1H, -4, -5H)	Measured at 66.67 MHz, loaded outputs, 15-pF load			200	ps
		Measured at 66.67 MHz, loaded outputs, 30-pF load			200	ps
		Measured at 133.3 MHz, loaded outputs, 15-pF load			100	ps
t _J	Cycle to Cycle Jitter ^[7] (-2, -3)	Measured at 66.67 MHz, loaded outputs 30-pF load			400	ps
		Measured at 66.67 MHz, loaded outputs 15-pF load			400	ps
t _{LOCK}	PLL Lock Time ^[7]	Stable power supply, valid clocks presented on REF and FBK pins			1.0	ms

Notes:

8. All parameters are specified with loaded outputs.

9. CY2308-5H has maximum input frequency of 133.33 MHz and maximum output of 66.67 MHz.

Operating Conditions for CY2308SI-XX Industrial Temperature Devices

Parameter	Description	Min.	Max.	Unit
V_{DD}	Supply Voltage	3.0	3.6	V
T_A	Operating Temperature (Ambient Temperature)	-40	85	°C
C_L	Load Capacitance, below 100 MHz		30	pF
	Load Capacitance, from 100 MHz to 133 MHz		15	pF
C_{IN}	Input Capacitance ^[6]		7	pF
t_{PU}	Power-up time for all V_{DDs} to reach minimum specified voltage (power ramps must be monotonic)	0.05	50	ms

Electrical Characteristics for CY2308SI-XX Industrial Temperature Devices

Parameter	Description	Test Conditions	Min.	Max.	Unit
V_{IL}	Input LOW Voltage			0.8	V
V_{IH}	Input HIGH Voltage		2.0		V
I_{IL}	Input LOW Current	$V_{IN} = 0V$		50.0	μA
I_{IH}	Input HIGH Current	$V_{IN} = V_{DD}$		100.0	μA
V_{OL}	Output LOW Voltage ^[7]	$I_{OL} = 8\text{ mA} (-1, -2, -3, -4)$ $I_{OL} = 12\text{ mA} (-1H, -5H)$		0.4	V
V_{OH}	Output HIGH Voltage ^[7]	$I_{OH} = -8\text{ mA} (-1, -2, -3, -4)$ $I_{OH} = -12\text{ mA} (-1H, -5H)$	2.4		V
I_{DD} (PD mode)	Power Down Supply Current	REF = 0 MHz		25.0	μA
I_{DD}	Supply Current	Unloaded outputs, 100 MHz, Select inputs at V_{DD} or GND		45.0	mA
				70(-1H,-5H)	mA
		Unloaded outputs, 66-MHz REF (-1, -2, -3, -4)		35.0	mA
				20.0	mA

Switching Characteristics for CY2308SI-XX Industrial Temperature Devices ^[8]

Parameter	Name	Test Conditions	Min.	Typ.	Max.	Unit
t ₁	Output Frequency	30-pF load, All devices	10		100	MHz
t ₁	Output Frequency	20-pF load, -1H, -5H devices ^[9]	10		133.3	MHz
t ₁	Output Frequency	15-pF load, -1, -2, -3, -4 devices	10		133.3	MHz
	Duty Cycle ^[7] = $t_2 \div t_1$ (-1, -2, -3, -4, -1H, -5H)	Measured at 1.4V, F _{OUT} = 66.66 MHz 30-pF load	40.0	50.0	60.0	%
	Duty Cycle ^[7] = $t_2 \div t_1$ (-1, -2, -3, -4, -1H, -5H)	Measured at 1.4V, F _{OUT} < 50.0 MHz 15-pF load	45.0	50.0	55.0	%
t ₃	Rise Time ^[7] (-1, -2, -3, -4)	Measured between 0.8V and 2.0V, 30-pF load			2.50	ns
t ₃	Rise Time ^[7] (-1, -2, -3, -4)	Measured between 0.8V and 2.0V, 15-pF load			1.50	ns
t ₃	Rise Time ^[7] (-1H, -5H)	Measured between 0.8V and 2.0V, 30-pF load			1.50	ns
t ₄	Fall Time ^[7] (-1, -2, -3, -4)	Measured between 0.8V and 2.0V, 30-pF load			2.50	ns
t ₄	Fall Time ^[7] (-1, -2, -3, -4)	Measured between 0.8V and 2.0V, 15-pF load			1.50	ns
t ₄	Fall Time ^[7] (-1H, -5H)	Measured between 0.8V and 2.0V, 30-pF load			1.25	ns
t ₅	Output to Output Skew on same Bank (-1, -2, -3, -4) ^[7]	All outputs equally loaded			200	ps
	Output to Output Skew (-1H, -5H)	All outputs equally loaded			200	ps
	Output Bank A to Output Bank B Skew (-1, -4, -5H)	All outputs equally loaded			200	ps
	Output Bank A to Output Bank B Skew (-2, -3)	All outputs equally loaded			400	ps
t ₆	Delay, REF Rising Edge to FBK Rising Edge ^[7]	Measured at V _{DD} /2		0	±250	ps
t ₇	Device to Device Skew ^[7]	Measured at V _{DD} /2 on the FBK pins of devices		0	700	ps
t ₈	Output Slew Rate ^[7]	Measured between 0.8V and 2.0V on -1H, -5H device using Test Circuit # 2	1			V/ns
t _J	Cycle to Cycle Jitter ^[7] (-1, -1H, -4, -5H)	Measured at 66.67 MHz, loaded outputs, 15-pF load			200	ps
		Measured at 66.67 MHz, loaded outputs, 30-pF load			200	ps
		Measured at 133.3 MHz, loaded outputs, 15 pF load			100	ps
t _J	Cycle to Cycle Jitter ^[7] (-2, -3)	Measured at 66.67 MHz, loaded outputs 30-pF load			400	ps
		Measured at 66.67 MHz, loaded outputs 15-pF load			400	ps
t _{LOCK}	PLL Lock Time ^[7]	Stable power supply, valid clocks presented on REF and FBK pins			1.0	ms

Switching Waveforms

Duty Cycle Timing

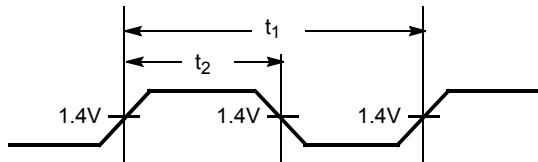

All Outputs Rise/Fall Time

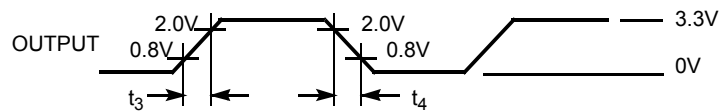

Output-Output Skew

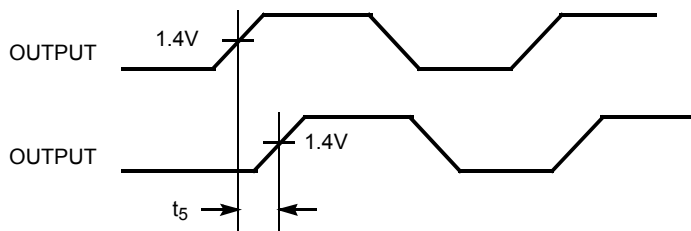

Input-Output Propagation Delay

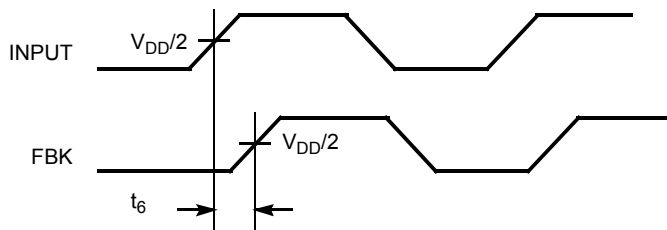

Device-Device Skew

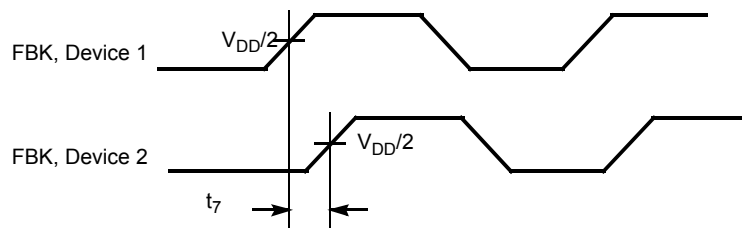

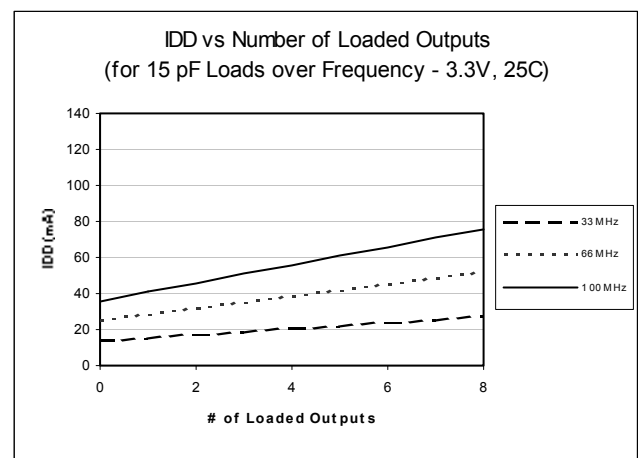
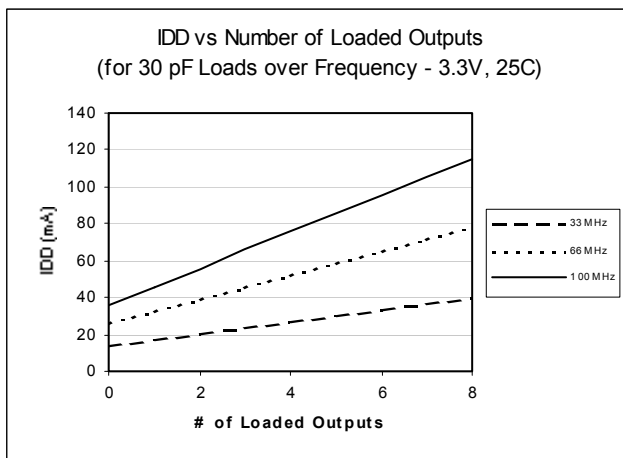
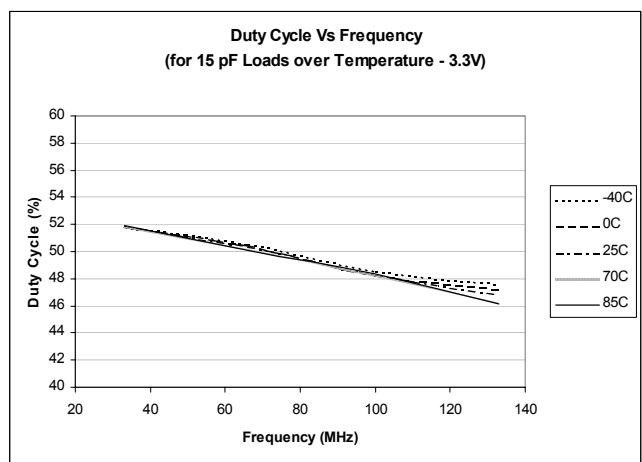
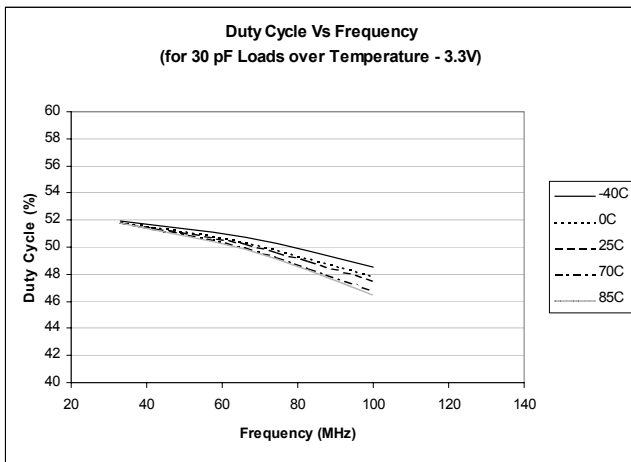
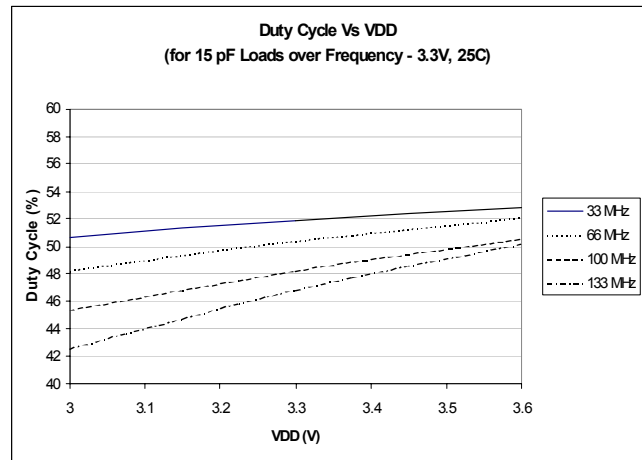
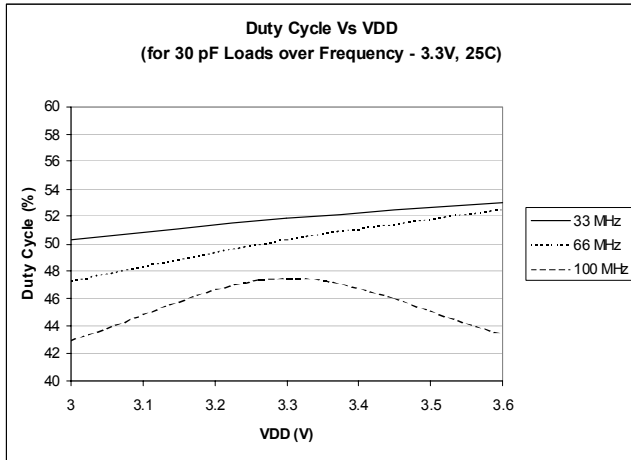
Typical Duty Cycle^[10] and I_{DD} Trends^[11] for CY2308-1,2,3,4

Notes:

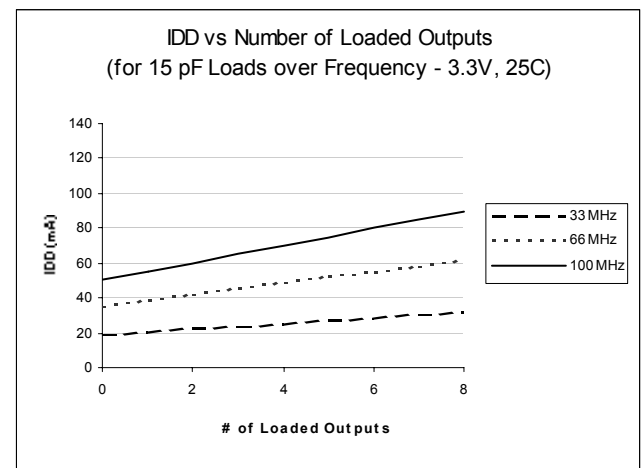
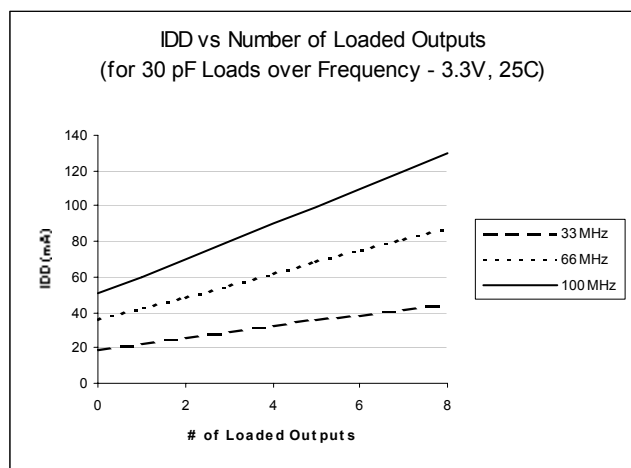
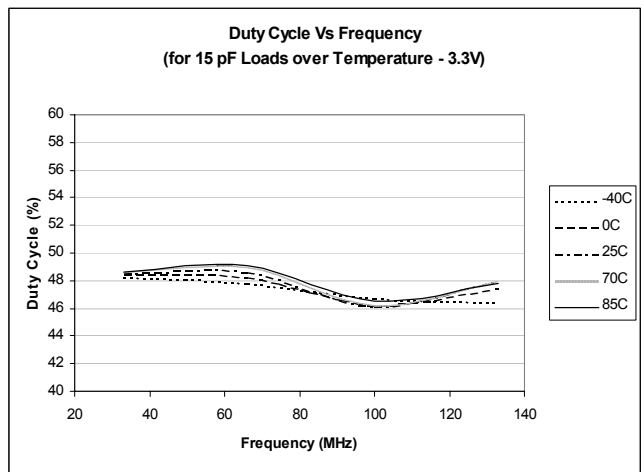
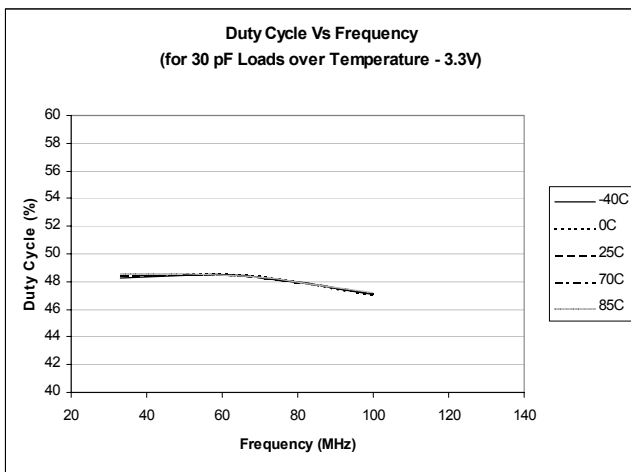
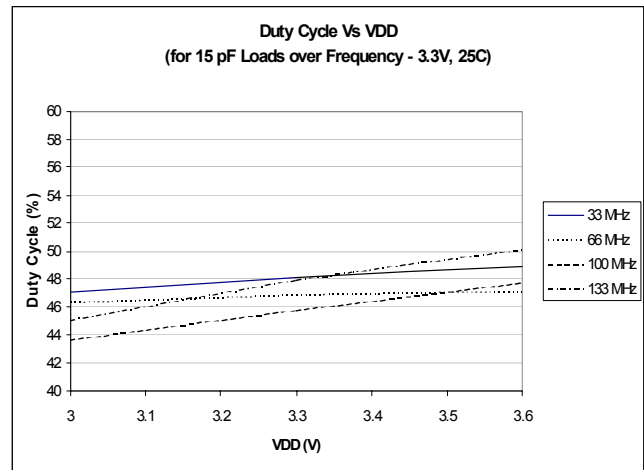
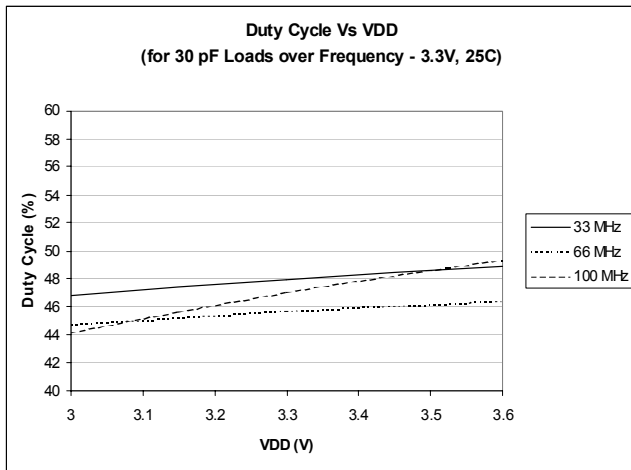
10. Duty Cycle is taken from typical chip measured at 1.4V.
11. I_{DD} data is calculated from $I_{DD} = I_{CORE} + nCVf$, where I_{CORE} is the unloaded current.
(n = # of outputs; C = Capacitance load per output (F); V = Voltage Supply (V); f = frequency (Hz))

Typical Duty Cycle^[10] and I_{DD} Trends^[11] for CY2308–1H, 5H

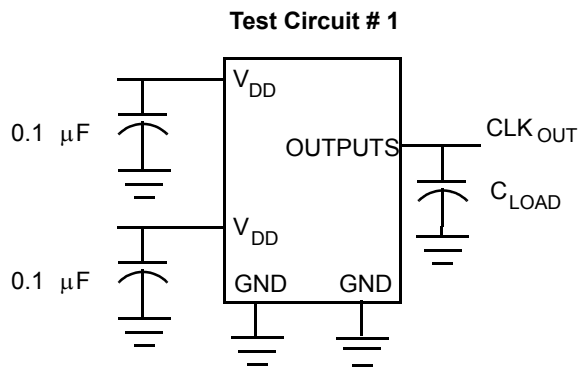
Test Circuits



Test Circuit for all parameters except t_8

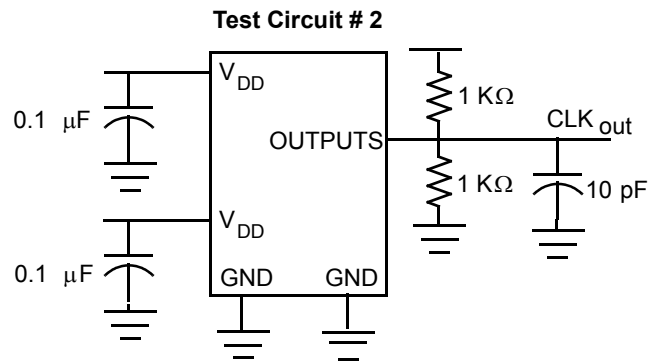

Test Circuit for t_8 , Output slew rate on -1H, -5 device

Ordering Information

Ordering Code	Package Name	Package Type	Operating Range
CY2308SC-1	S16	16-pin 150-mil SOIC	Commercial
CY2308SI-1	S16	16-pin 150-mil SOIC	Industrial
CY2308SC-1H	S16	16-pin 150-mil SOIC	Commercial
CY2308SI-1H	S16	16-pin 150-mil SOIC	Industrial
CY2308ZC-1H	Z16	16-pin 150-mil TSSOP	Commercial
CY2308ZI-1H	Z16	16-pin 150-mil TSSOP	Industrial
CY2308SC-2	S16	16-pin 150-mil SOIC	Commercial
CY2308SI-2	S16	16-pin 150-mil SOIC	Industrial
CY2308SC-3	S16	16-pin 150-mil SOIC	Commercial
CY2308SI-3	S16	16-pin 150-mil SOIC	Industrial
CY2308SC-4	S16	16-pin 150-mil SOIC	Commercial
CY2308SI-4	S16	16-pin 150-mil SOIC	Industrial
CY2308SC-5H	S16	16-pin 150-mil SOIC	Commercial
CY2308SI-5H	S16	16-pin 150-mil SOIC	Industrial
CY2308ZC-5H	Z16	16-pin 150-mil TSSOP	Commercial
CY2308ZI-5H	Z16	16-pin 150-mil TSSOP	Industrial
Lead Free			
CY2308SXC-1	S16	16-pin 150-mil SOIC	Commercial
CY2308SXI-1	S16	16-pin 150-mil SOIC	Industrial
CY2308SXC-1H	S16	16-pin 150-mil SOIC	Commercial
CY2308SXI-1H	S16	16-pin 150-mil SOIC	Industrial
CY2308ZXC-1H	Z16	16-pin 150-mil TSSOP	Commercial
CY2308ZXI-1H	Z16	16-pin 150-mil TSSOP	Industrial
CY2308SXC-2	S16	16-pin 150-mil SOIC	Commercial
CY2308SXI-2	S16	16-pin 150-mil SOIC	Industrial
CY2308SXC-3	S16	16-pin 150-mil SOIC	Commercial
CY2308SXI-3	S16	16-pin 150-mil SOIC	Industrial
CY2308SXC-4	S16	16-pin 150-mil SOIC	Commercial
CY2308SXI-4	S16	16-pin 150-mil SOIC	Industrial
CY2308SXC-5H	S16	16-pin 150-mil SOIC	Commercial
CY2308SXI-5H	S16	16-pin 150-mil SOIC	Industrial
CY2308ZXC-5H	Z16	16-pin 150-mil TSSOP	Commercial
CY2308ZXI-5H	Z16	16-pin 150-mil TSSOP	Industrial

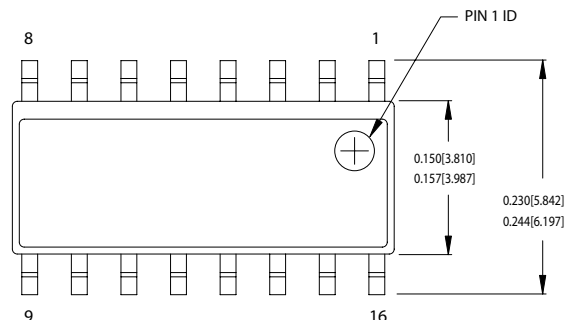
Package Drawings and Dimensions
16-Lead (150-Mil) SOIC S16.15

DIMENSIONS IN INCHES[MM] MIN. MAX.
 REFERENCE JEDEC MS-012
 PACKAGE WEIGHT 0.15gms

PART #	
S16.15	STANDARD PKG.
SZ16.15	LEAD FREE PKG.

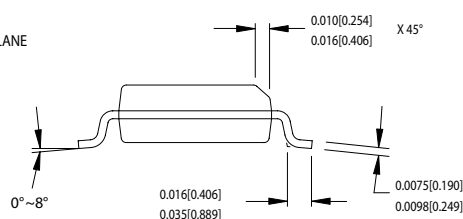
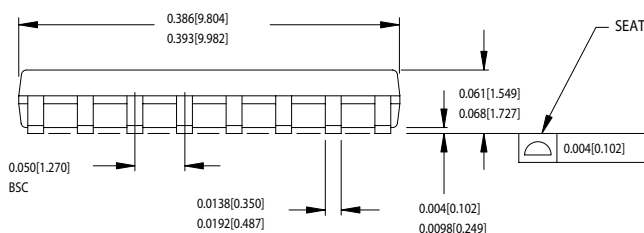

51-85068-*B

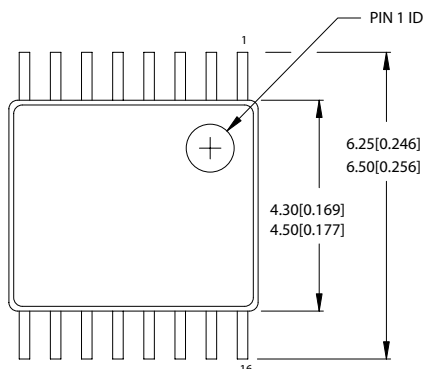
16-lead TSSOP 4.40 MM Body Z16.173

DIMENSIONS IN MM[INCHES] MIN. MAX.
 REFERENCE JEDEC MO-153
 PACKAGE WEIGHT 0.05 gms

PART #	
Z16.173	STANDARD PKG.
ZZ16.173	LEAD FREE PKG.

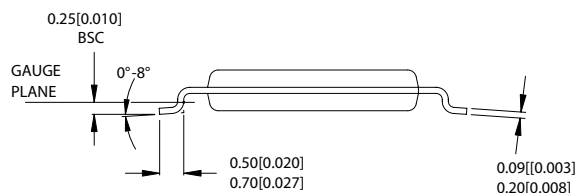
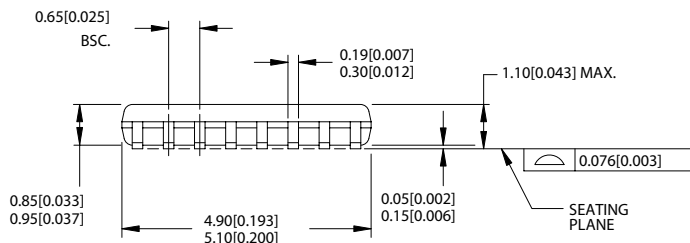

51-85091-*A

All product and company names mentioned in this document may be the trademarks of their respective holders

.Document History Page

Document Title: CY2308 3.3V Zero Delay Buffer				
Document Number: 38-07146				
REV.	ECN NO.	Issue Date	Orig. of Change	Description of Change
**	110255	12/17/01	SZV	Change from Spec number: 38-00528 to 38-07146
*A	118722	10/31/02	RGL	Added Note 1 in page 2.
*B	121832	12/14/02	RBI	Power up requirements added to Operating Conditions Information
*C	235854	See ECN	RGL	Added Lead Free Devices