

Ordering number : ENN7916



SANYO Semiconductors DATA SHEET

CPH3424 — N-Channel Silicon MOSFET General-Purpose Switching Device Applications

Features

- Low ON-resistance.
- Ultrahigh-speed switching.
- 4V drive.

Specifications

Absolute Maximum Ratings at Ta=25°C

Parameter	Symbol	Conditions	Ratings	Unit
Drain-to-Source Voltage	V _{DSS}		60	V
Gate-to-Source Voltage	V _{GSS}		±20	V
Drain Current (DC)	I _D		1.8	A
Drain Current (Pulse)	I _{DP}	PW≤10μs, duty cycle≤1%	7.2	A
Allowable Power Dissipation	P _D	Mounted on a ceramic board (900mm²X0.8mm)	1	W
Channel Temperature	T _{ch}		150	°C
Storage Temperature	T _{stg}		-55 to +150	°C

Electrical Characteristics at Ta=25°C

Parameter	Symbol	Conditions	Ratings			Unit
			min	typ	max	
Drain-to-Source Breakdown Voltage	V(BR)DSS	I _D =1mA, V _{GS} =0	60			V
Zero-Gate Voltage Drain Current	I _{DSS}	V _{DS} =60V, V _{GS} =0			1	μA
Gate-to-Source Leakage Current	I _{GSS}	V _{GS} =±16V, V _{DS} =0			±10	μA
Cutoff Voltage	V _{GS(off)}	V _{DS} =10V, I _D =1mA	1.2		2.6	V
Forward Transfer Admittance	y _{fs}	V _{DS} =10V, I _D =0.9A	1.1	2.1		S
Static Drain-to-Source On-State Resistance	R _{DS(on)1}	I _D =0.9A, V _{GS} =10V		170	220	mΩ
	R _{DS(on)2}	I _D =0.9A, V _{GS} =4V		210	300	mΩ
Input Capacitance	C _{iss}	V _{DS} =20V, f=1MHz		220		pF
Output Capacitance	C _{oss}	V _{DS} =20V, f=1MHz		28		pF
Reverse Transfer Capacitance	C _{rss}	V _{DS} =20V, f=1MHz		20		pF
Turn-ON Delay Time	t _{d(on)}	See specified Test Circuit.		8		ns
Rise Time	t _r	See specified Test Circuit.		5		ns
Turn-OFF Delay Time	t _{d(off)}	See specified Test Circuit.		27		ns
Fall Time	t _f	See specified Test Circuit.		20		ns

Marking : KZ

Continued on next page.

■ Any and all SANYO products described or contained herein do not have specifications that can handle applications that require extremely high levels of reliability, such as life-support systems, aircraft's control systems, or other applications whose failure can be reasonably expected to result in serious physical and/or material damage. Consult with your SANYO representative nearest you before using any SANYO products described or contained herein in such applications.

■ SANYO assumes no responsibility for equipment failures that result from using products at values that exceed, even momentarily, rated values (such as maximum ratings, operating condition ranges, or other parameters) listed in products specifications of any and all SANYO products described or contained herein.

SANYO Electric Co.,Ltd. Semiconductor Company

TOKYO OFFICE Tokyo Bldg., 1-10, 1 Chome, Ueno, Taito-ku, TOKYO, 110-8534 JAPAN

93004 TS IM TA-100207 No.7916-1/4

CPH3424

Continued from preceding page.

Parameter	Symbol	Conditions	Ratings			Unit
			min	typ	max	
Total Gate Charge	Qg	V _{DS} =30V, V _{GS} =10V, I _D =1.8A		6.4		nC
Gate-to-Source Charge	Qgs	V _{DS} =30V, V _{GS} =10V, I _D =1.8A		1.1		nC
Gate-to-Drain "Miller" Charge	Qgd	V _{DS} =30V, V _{GS} =10V, I _D =1.8A		1.1		nC
Diode Forward Voltage	V _{SD}	I _S =1.8A, V _{GS} =0		0.85	1.2	V

Package Dimensions

unit : mm

2152A

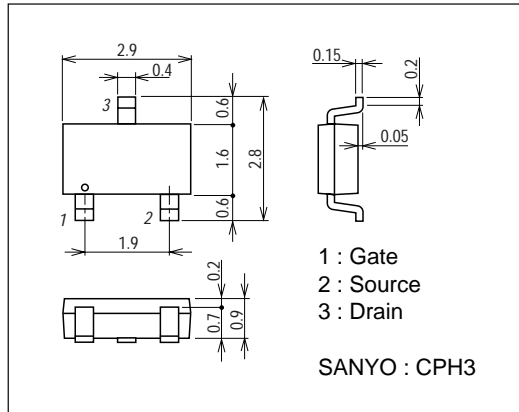

Switching Time Test Circuit

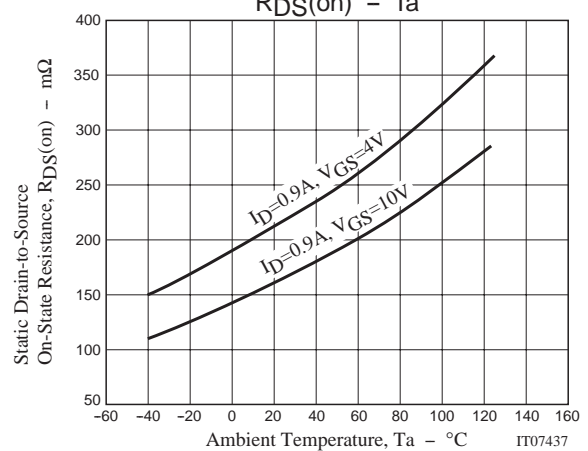
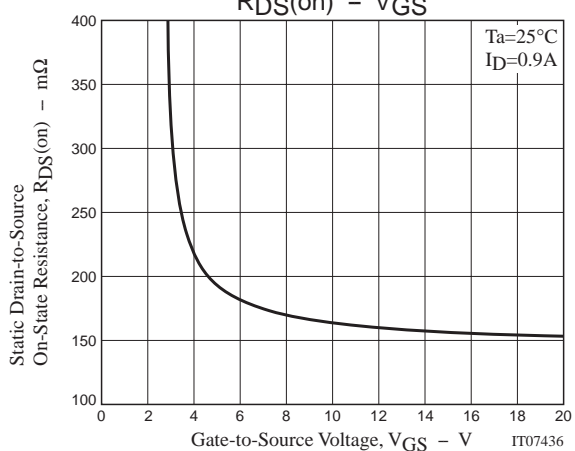
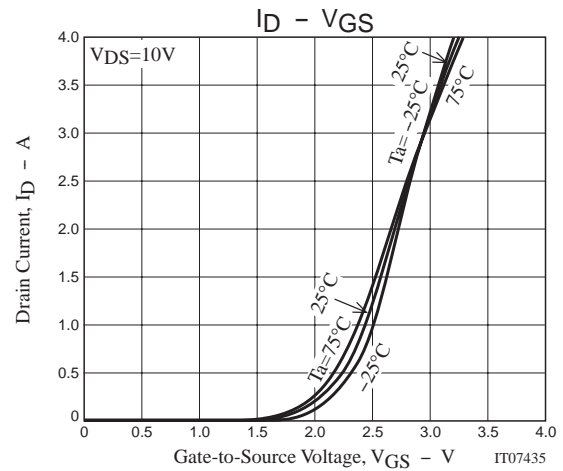
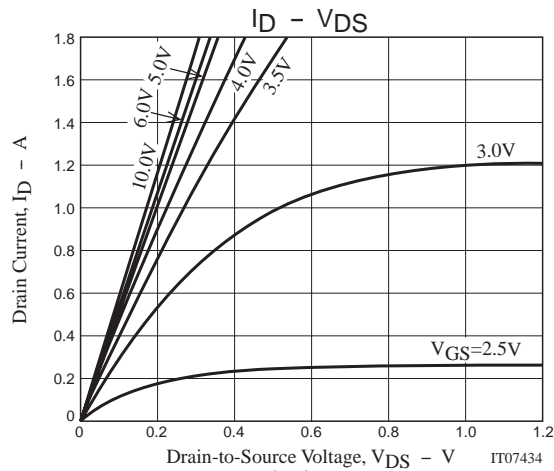
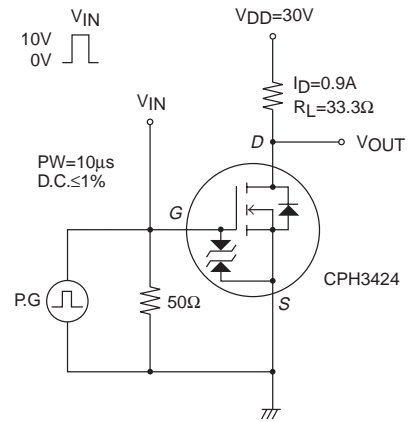

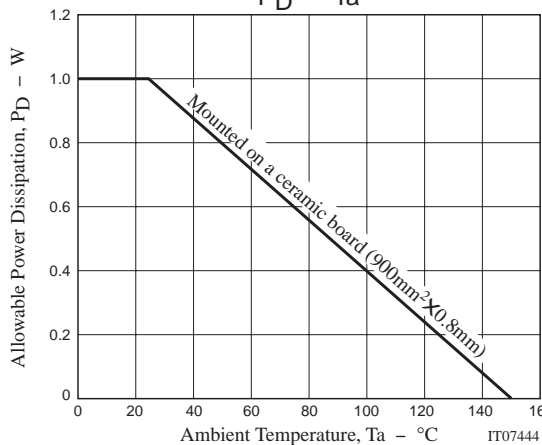
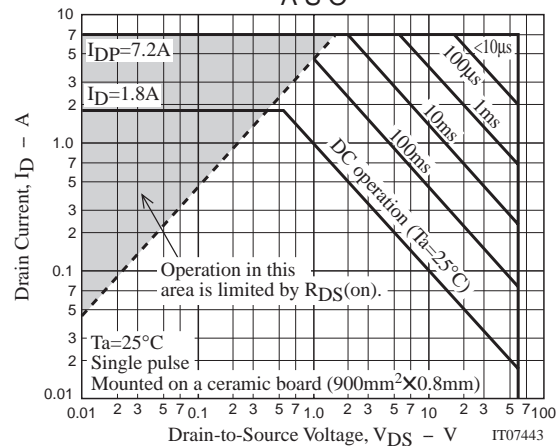
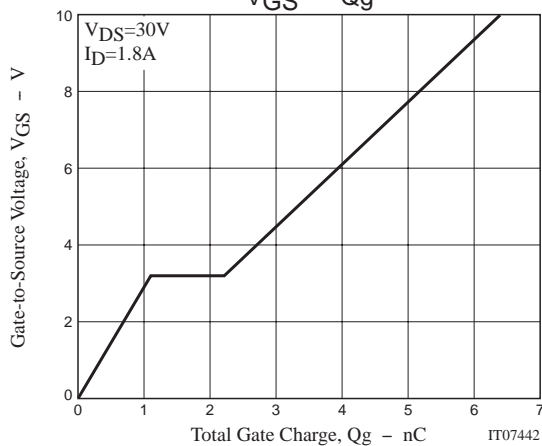
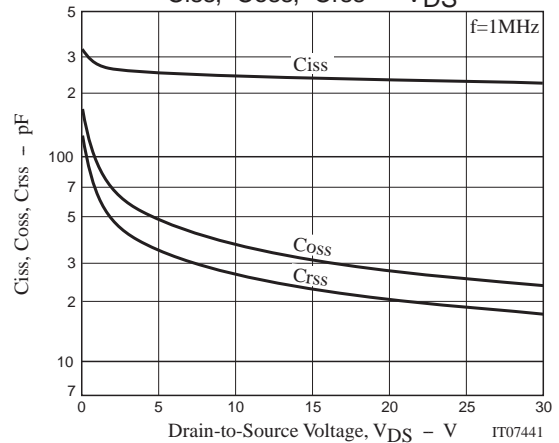
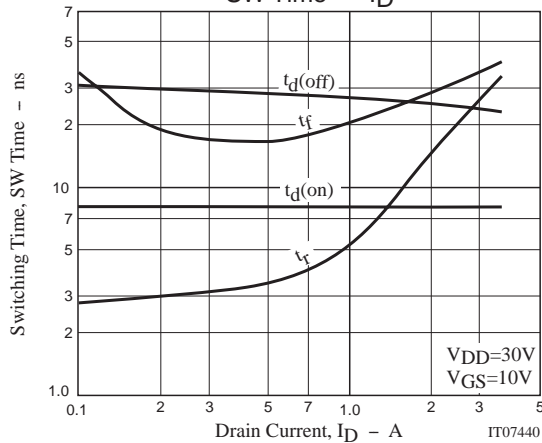
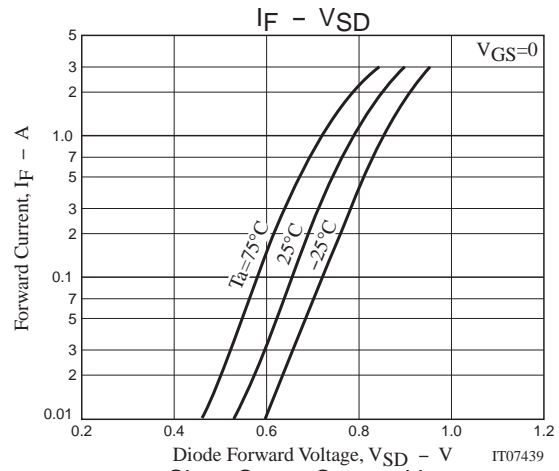
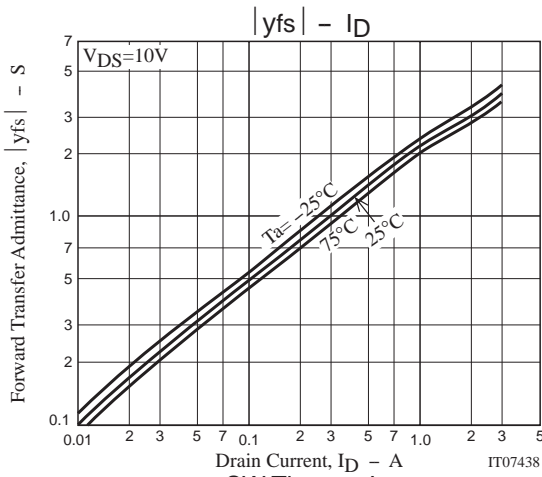

Note on usage : Since the CPH3424 is a MOSFET product, please avoid using this device in the vicinity of highly charged objects.

- Specifications of any and all SANYO products described or contained herein stipulate the performance, characteristics, and functions of the described products in the independent state, and are not guarantees of the performance, characteristics, and functions of the described products as mounted in the customer's products or equipment. To verify symptoms and states that cannot be evaluated in an independent device, the customer should always evaluate and test devices mounted in the customer's products or equipment.
- SANYO Electric Co., Ltd. strives to supply high-quality high-reliability products. However, any and all semiconductor products fail with some probability. It is possible that these probabilistic failures could give rise to accidents or events that could endanger human lives, that could give rise to smoke or fire, or that could cause damage to other property. When designing equipment, adopt safety measures so that these kinds of accidents or events cannot occur. Such measures include but are not limited to protective circuits and error prevention circuits for safe design, redundant design, and structural design.
- In the event that any or all SANYO products(including technical data, services) described or contained herein are controlled under any of applicable local export control laws and regulations, such products must not be exported without obtaining the export license from the authorities concerned in accordance with the above law.
- No part of this publication may be reproduced or transmitted in any form or by any means, electronic or mechanical, including photocopying and recording, or any information storage or retrieval system, or otherwise, without the prior written permission of SANYO Electric Co., Ltd.
- Any and all information described or contained herein are subject to change without notice due to product/technology improvement, etc. When designing equipment, refer to the "Delivery Specification" for the SANYO product that you intend to use.
- Information (including circuit diagrams and circuit parameters) herein is for example only ; it is not guaranteed for volume production. SANYO believes information herein is accurate and reliable, but no guarantees are made or implied regarding its use or any infringements of intellectual property rights or other rights of third parties.

This catalog provides information as of September, 2004. Specifications and information herein are subject to change without notice.