

# CCFL Driving Inverter Transformer

## INT009S TYPE (EPC7.6\*20)

Mechanical Dimension:Unit:mm

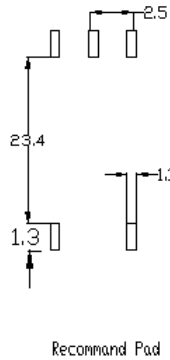
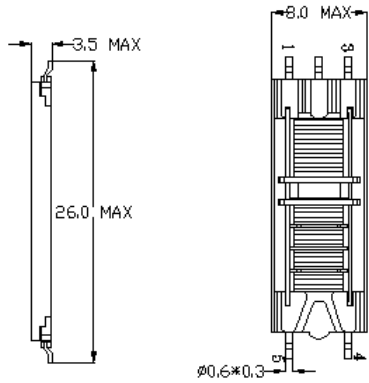

2. SCHEMATIC :

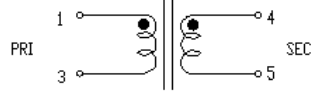

Characteristic (reference)

PART NO.	INPUTVOLTAGE (Vdc)	SUITABLE FREQUENCY (KHZ)	MAX. LAMP WATTE (W)	MAX. OPEN VOLTAGE (Vrms)	EFFICIENCY (%)
INT009S-1	38243.0	50-200	1.5	1600	80

## INT010S TYPE (EPC18)

Mechanical Dimension:Unit:mm

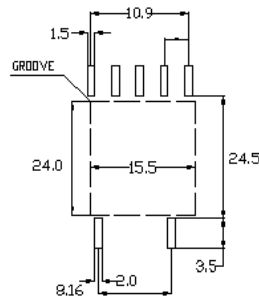
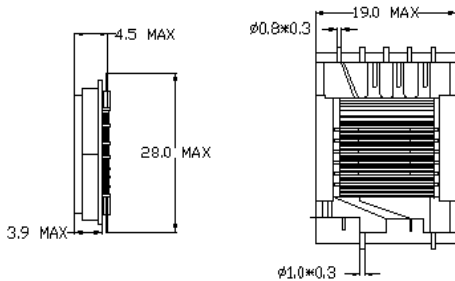

2. Schematic:

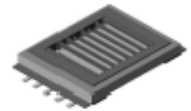
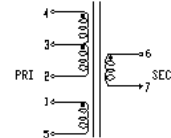

Characteristic (reference)

PART NO.	INPUTVOLTAGE (Vdc)	SUITABLE FREQUENCY (KHZ)	MAX. LAMP WATTE (W)	MAX. OPEN VOLTAGE (Vrms)	EFFICIENCY (%)
INT010S-1	9.0	30-80	1.2	1350	80-85



沙井欣旺电子有限公司

XINWANG ELECTRONICS, INC. [HTTP://:WWW.XINWANGELE.COM](http://www.xinwangele.com)  
 TEL: 0755-29696626 FAX: 0755-27289711  
 E-mail: sales@xinwangele.com