

FODM8801A, FODM8801B, FODM8801C

OptoHiT™ Series, High Temperature Phototransistor Optocoupler in Half Pitch Mini-Flat 4-Pin Package

Features

- Utilizing patented process technology to achieve high operating temperature up to 125°C
- Guaranteed Current Transfer Ratio (CTR) specifications across full temperature range
 - Excellent CTR linearity at high temperature
 - CTR at very low input current, I_F
- High isolation voltage regulated by safety agency, UL1577, 3750 VAC_{RMS} for 1 min. and DIN EN/IEC60747-5-2 (pending approval)
- Compact half pitch, mini-flat, 4-pin package (1.27mm lead pitch, 2.4mm maximum standoff height)
- > 5mm creepage and clearance distance
- Applicable to Infrared Ray reflow, 245°C

Applications

- Primarily suited for DC-DC converters
- For ground loop isolation, signal to noise isolation
- Communications – adapters, chargers
- Consumer – appliances, set top boxes
- Industrial – power supplies, motor control, programmable logic control

Description

The OptoHiT™ Series, FODM8801, is a first of its kind phototransistor, utilizing Fairchild's leading edge patented process technology to achieving high operating temperature characteristics, up to 125°C. The optocoupler consists of an aluminum gallium arsenide (AlGaAs) infrared light emitting diode optically coupled to a phototransistor, in a compact half pitch, mini-flat, 4-pin package. It delivers high current transfer ratio at very low input current. The input-output isolation voltage, Viso, is rated at 3750 VAC_{RMS}.

Schematic

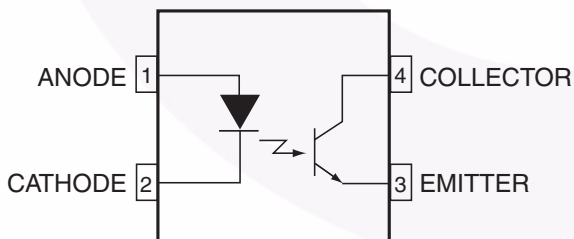

Package Drawing

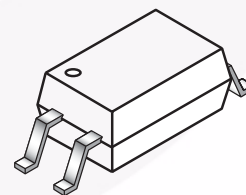

Safety and Insulation Ratings for Half-Pitch Mini-Flat Package

Symbol	Parameter	Min.	Typ.	Max.	Unit
	Installation Classifications per DIN VDE 0110/1.89 Table 1				
	For rated main voltage < 150Vrms		I-IV		
	For rated main voltage < 300Vrms		I-III		
	Climatic Classification		40/125/21		
	Pollution Degree (DIN VDE 0110/1.89)		2		
CTI	Comparative Tracking Index	175			
V _{PR}	Input to Output Test Voltage, Method b, V _{IORM} x 1.875 = V _{PR} , 100% Production Test with t _m = 1 sec, Partial Discharge < 5pC	1060			V _{peak}
V _{PR}	Input to Output Test Voltage, Method a, V _{IORM} x 1.5 = V _{PR} , Type and Sample Test with t _m = 60 sec, Partial Discharge < 5pC	848			V _{peak}
V _{IORM}	Max Working Insulation Voltage	565			V _{peak}
V _{IOTM}	Highest Allowable Over Voltage	4000			V _{peak}
	External Creepage	5			mm
	External Clearance	5			mm
	Insulation thickness	0.5			mm
T _S	Safety Limit Values- Maximum Values allowed in the event of a failure, Case Temperature	150			°C
I _{S,INPUT}	Input Current	200			mA
P _{S,OUTPUT}	Output Power	300			mW
R _{IO}	Insulation Resistance at T _S , V _{IO} =500V	10 ⁹			Ω

Absolute Maximum Ratings ($T_A = 25^\circ\text{C}$ unless otherwise specified)

Stresses exceeding the absolute maximum ratings may damage the device. The device may not function or be operable above the recommended operating conditions and stressing the parts to these levels is not recommended. In addition, extended exposure to stresses above the recommended operating conditions may affect device reliability. The absolute maximum ratings are stress ratings only.

Symbol	Parameter	Value	Units
TOTAL PACKAGE			
T_{STG}	Storage Temperature	-40 to +150	$^\circ\text{C}$
T_{OPR}	Operating Temperature	-40 to +125	$^\circ\text{C}$
T_{J}	Junction Temperature	-40 to +140	$^\circ\text{C}$
T_{SOL}	Lead Solder Temperature (Refer to Reflow Temperature Profile on page 11)	260 for 10 sec.	$^\circ\text{C}$
EMITTER			
$I_{\text{F(average)}}$	Continuous Forward Current	20	mA
V_{R}	Reverse Input Voltage	6	V
PD_{LED}	Power Dissipation ⁽¹⁾⁽³⁾	40	mW
DETECTOR			
$I_{\text{C(average)}}$	Continuous Collector Current	30	mA
V_{CEO}	Collector-Emitter Voltage	75	V
V_{ECO}	Emitter-Collector Voltage	7	V
PD_{C}	Collector Power Dissipation ⁽²⁾⁽³⁾	150	mW

Recommended Operating Conditions

The Recommended Operating Conditions table defines the conditions for actual device operation. Recommended operating conditions are specified to ensure optimal performance to the datasheet specifications. Fairchild does not recommend exceeding them or designing to absolute maximum ratings.

Symbol	Parameter	Value	Units
T_A	Operating Temperature	-40 to +125	$^\circ\text{C}$
$V_{\text{FL(OFF)}}$	Input Low Voltage	-5 to 0.8	V
I_{FH}	Input High Forward Current	1 to 10	mA

Isolation Characteristics

Symbol	Parameter	Test Conditions	Min.	Typ.	Max.	Unit
V_{ISO}	Input-Output Isolation Voltage	$f = 60\text{Hz}$, $t = 1\text{min.}$, $I_{\text{I-O}} \leq 10\mu\text{A}^{(4)(5)}$	3,750			$V_{\text{AC,RMS}}$
R_{ISO}	Isolation Resistance	$V_{\text{I-O}} = 500\text{V}^{(4)}$	10^{12}			Ω
C_{ISO}	Isolation Capacitance	Freq. = 1MHz		0.3	0.5	pF

Notes:

- Derate linearly from 73°C at a rate of $0.24\text{mW}/^\circ\text{C}$
- Derate linearly from 73°C at a rate of $2.23\text{mW}/^\circ\text{C}$.
- Functional operation under these conditions is not implied. Permanent damage may occur if the device is subjected to conditions outside these ratings.
- Device is considered a two terminal device: Pins 1 and 2 are shorted together and Pins 3 and 4 are shorted together.
- 3,750 $V_{\text{AC,RMS}}$ for 1 minute duration is equivalent to 4,500 $V_{\text{AC,RMS}}$ for 1 second duration.

Electrical Characteristics

Apply over all recommended conditions ($T_A = -40^{\circ}\text{C}$ to $+125^{\circ}\text{C}$ unless otherwise specified).
All typical values are measured at $T_A = 25^{\circ}\text{C}$.

Symbol	Parameter	Conditions	Min.	Typ.	Max.	Units
EMITTER						
V_F	Forward Voltage	$I_F = 1\text{mA}$	1.0	1.35	1.8	V
$\Delta V_F / \Delta T_A$	Forward Voltage Coefficient	$I_F = 1\text{mA}$		-1.6		mV / $^{\circ}\text{C}$
I_R	Reverse Current	$V_R = 6\text{V}$			10	μA
C_T	Terminal Capacitance	$V = 0\text{V}, f = 1\text{MHz}$		30		pF
DETECTOR						
BV_{CEO}	Collector-Emitter Breakdown Voltage	$I_C = 0.5\text{mA}, I_F = 0\text{mA}$	75	130		V
BV_{ECO}	Emitter-Collector Breakdown Voltage	$I_E = 100\mu\text{A}, I_F = 0\text{mA}$	7	12		V
I_{CEO}	Collector Dark Current	$V_{CE} = 75\text{V}, I_F = 0\text{mA}, T_A = 25^{\circ}\text{C}$			100	nA
		$V_{CE} = 50\text{V}, I_F = 0\text{mA}$			50	μA
		$V_{CE} = 5\text{V}, I_F = 0\text{mA}$			30	μA
C_{CE}	Capacitance	$V_{CE} = 0\text{V}, f = 1\text{MHz}$		8		pF

Transfer Characteristics

Apply over all recommended conditions ($T_A = -40^\circ\text{C}$ to $+125^\circ\text{C}$ unless otherwise specified).
All typical values are measured at $T_A = 25^\circ\text{C}$.

Symbol	Parameter	Device	Conditions	Min.	Typ.	Max.	Units
CTR _{CE}	Current Transfer Ratio (collector-emitter)	FODM8801A	I _F = 1.0mA, V _{CE} = 5V @ T _A = 25°C	80	120	160	%
			I _F = 1.0mA, V _{CE} = 5V	35	120	230	%
			I _F = 1.6mA, V _{CE} = 5V	40	125		%
			I _F = 3.0mA, V _{CE} = 5V	45	138		%
		FODM8801B	I _F = 1.0mA, V _{CE} = 5V @ T _A = 25°C	130	195	260	%
			I _F = 1.0mA, V _{CE} = 5V	65	195	360	%
			I _F = 1.6mA, V _{CE} = 5V	70	202		%
			I _F = 3.0mA, V _{CE} = 5V	75	215		%
		FODM8801C	I _F = 1.0mA, V _{CE} = 5V @ T _A = 25°C	200	300	400	%
			I _F = 1.0mA, V _{CE} = 5V	100	300	560	%
			I _F = 1.6mA, V _{CE} = 5V	110	312		%
			I _F = 3.0mA, V _{CE} = 5V	115	330		%
CTR _{CE(SAT)}	Saturated Current Transfer Ratio (collector-emitter)	FODM8801A	I _F = 1.0mA, V _{CE} = 0.4V @ T _A = 25°C	65	108	150	%
			I _F = 1.0mA, V _{CE} = 0.4V	30	108		%
			I _F = 1.6mA, V _{CE} = 0.4V	25	104		%
			I _F = 3.0mA, V _{CE} = 0.4V	20	92		%
		FODM8801B	I _F = 1.0mA, V _{CE} = 0.4V @ T _A = 25°C	90	168	245	%
			I _F = 1.0mA, V _{CE} = 0.4V	45	168		%
			I _F = 1.6mA, V _{CE} = 0.4V	40	155		%
			I _F = 3.0mA, V _{CE} = 0.4V	35	132		%
		FODM8801C	I _F = 1.0mA, V _{CE} = 0.4V @ T _A = 25°C	140	238	380	%
			I _F = 1.0mA, V _{CE} = 0.4V	75	238		%
			I _F = 1.6mA, V _{CE} = 0.4V	65	215		%
			I _F = 3.0mA, V _{CE} = 0.4V	55	177		%
V _{CE(SAT)}	Saturation Voltage	FODM8801A	I _F = 1.0mA, I _C = 0.3mA		0.17	0.4	V
			I _F = 1.6mA, I _C = 0.4mA		0.16	0.4	V
			I _F = 3.0mA, I _C = 0.6mA		0.15	0.4	V
		FODM8801B	I _F = 1.0mA, I _C = 0.45mA		0.17	0.4	V
			I _F = 1.6mA, I _C = 0.6mA		0.16	0.4	V
			I _F = 3.0mA, I _C = 1.0mA		0.16	0.4	V
		FODM8801C	I _F = 1.0mA, I _C = 0.75mA		0.18	0.4	V
			I _F = 1.6mA, I _C = 1.0mA		0.17	0.4	V
			I _F = 3.0mA, I _C = 1.6mA		0.17	0.4	V

Switching Characteristics

Apply over all recommended conditions ($T_A = -40^\circ\text{C}$ to $+125^\circ\text{C}$ unless otherwise specified).
All typical values are measured at $T_A = 25^\circ\text{C}$.

Symbol	Parameter	Device	Conditions	Min.	Typ.	Max.	Units
t_{ON}	Turn On Time	All Devices	$I_F = 1.6\text{mA}$, $V_{CC} = 5\text{V}$, $R_L = 0.75\text{k}\Omega$	1	6	20	μs
			$I_F = 1.6\text{mA}$, $V_{CC} = 5\text{V}$, $R_L = 4.7\text{k}\Omega$		6		μs
t_{OFF}	Turn Off Time	All Devices	$I_F = 1.6\text{mA}$, $V_{CC} = 5\text{V}$, $R_L = 0.75\text{k}\Omega$	1	6	20	μs
			$I_F = 1.6\text{mA}$, $V_{CC} = 5\text{V}$, $R_L = 4.7\text{k}\Omega$		40		μs
t_R	Output Rise Time (10% to 90%)	All Devices	$I_F = 1.6\text{mA}$, $V_{CC} = 5\text{V}$, $R_L = 0.75\text{k}\Omega$		5		μs
t_F	Output Fall Time (90% to 10%)	All Devices	$I_F = 1.6\text{mA}$, $V_{CC} = 5\text{V}$, $R_L = 0.75\text{k}\Omega$		5.5		μs
CM_H	Common Mode Rejection Voltage (Transient Immunity) – Output High	All Devices	$T_A = 25^\circ\text{C}$, $I_F = 0\text{mA}$, $V_O > 2.0\text{V}$, $R_L = 4.7\text{k}\Omega$, $V_{CM} = 1000\text{V}^{(6)}$, Figure 14		20		$\text{kV} / \mu\text{s}$
CM_L	Common Mode Rejection Voltage (Transient Immunity) – Output Low	All Devices	$T_A = 25^\circ\text{C}$, $I_F = 1.6\text{mA}$, $V_O < 0.8\text{V}$, $R_L = 4.7\text{k}\Omega$, $V_{CM} = 1000\text{V}^{(6)}$, Figure 14		20		$\text{kV} / \mu\text{s}$

Note:

6. Common mode transient immunity at output high is the maximum tolerable positive dV_{cm}/dt on the leading edge of the common mode impulse signal, V_{cm} , to assure that the output will remain high.

Typical Performance Curves

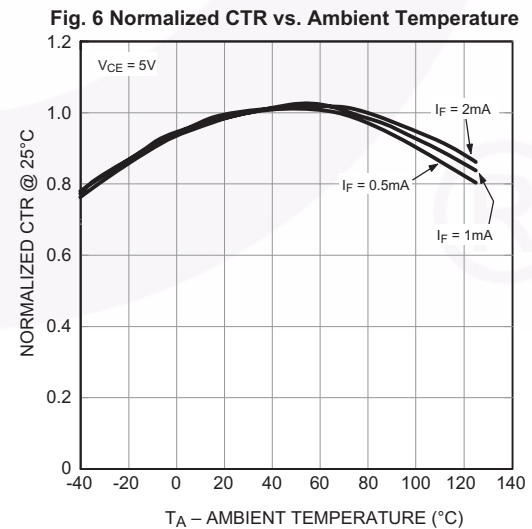
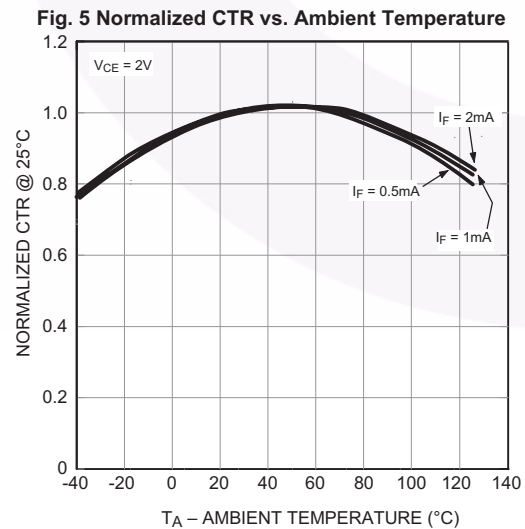
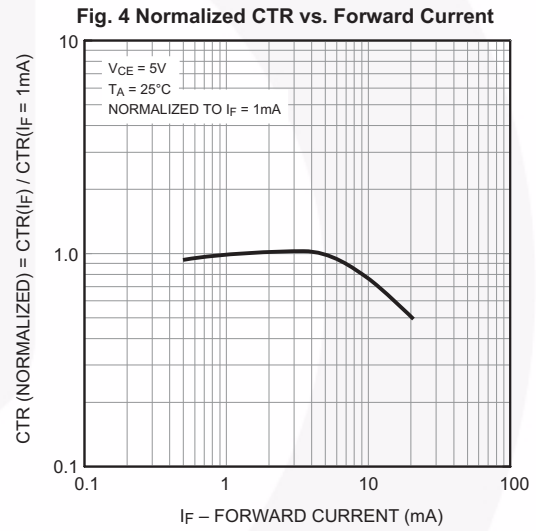
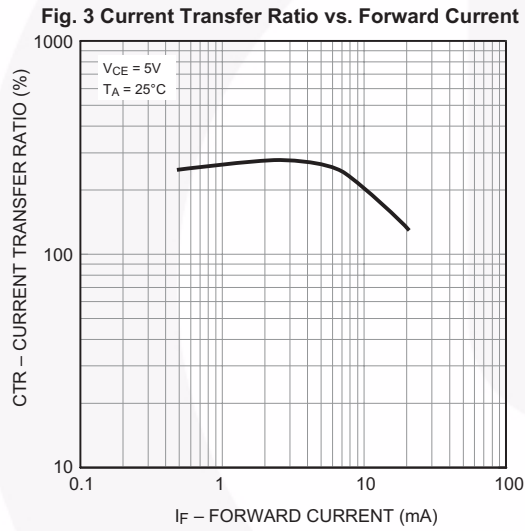
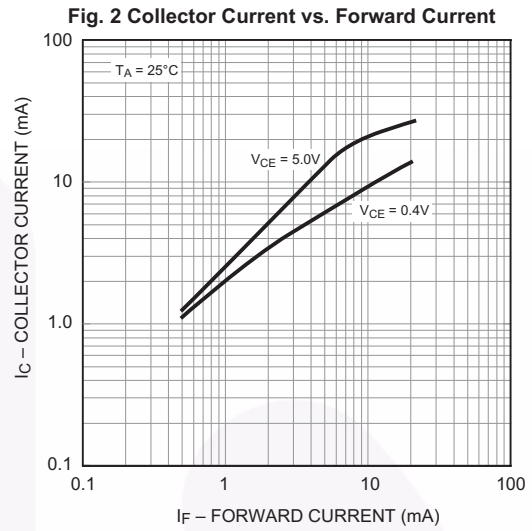
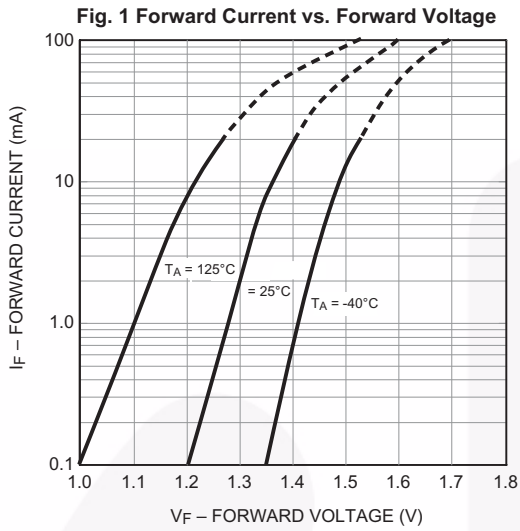

Typical Performance Curves (Continued)

Fig. 7 Collector Current vs. Ambient Temperature

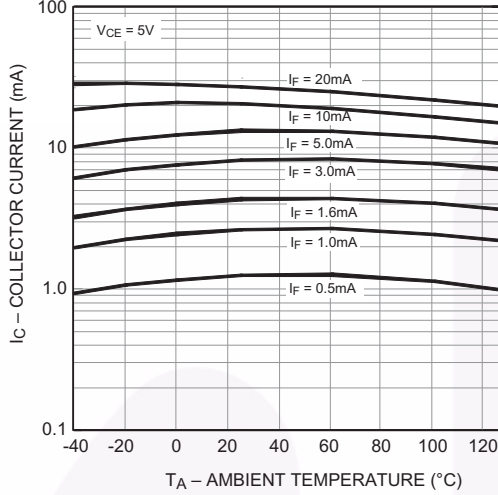

Fig. 8 Collector Current vs. Collector-Emitter Voltage

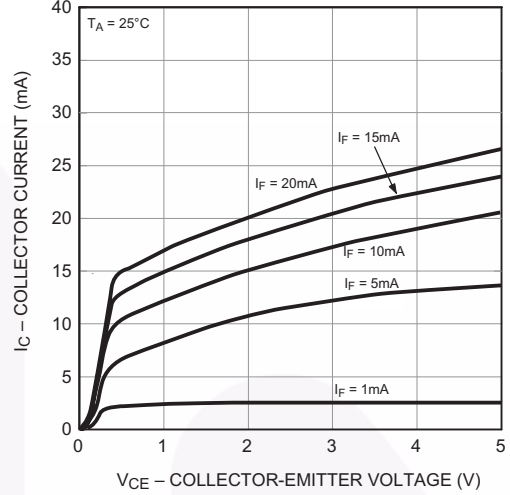

Fig. 9 Collector Dark Current vs. Ambient Temperature

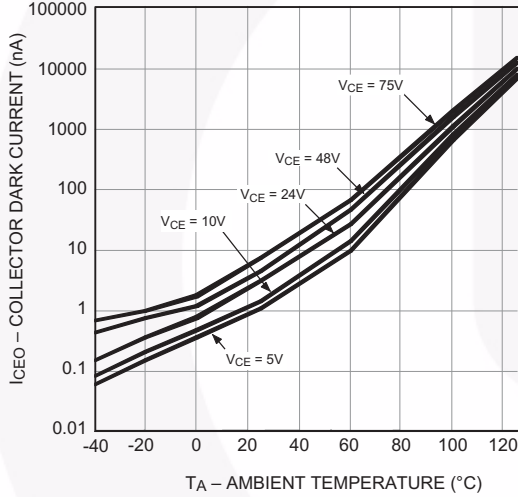

Fig. 10 Switching Time vs. Load Resistance

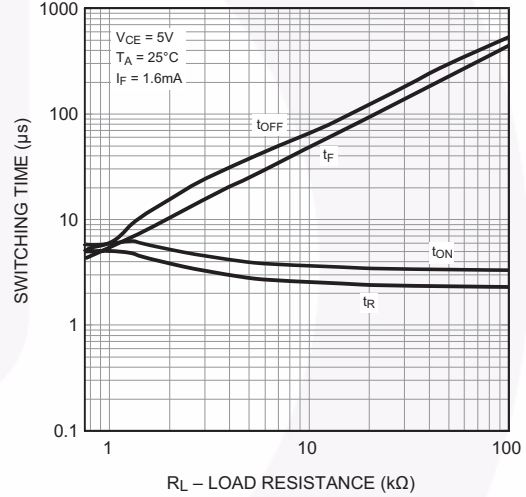

Fig. 11 Collector-Emitter Saturation Voltage vs. Ambient Temperature

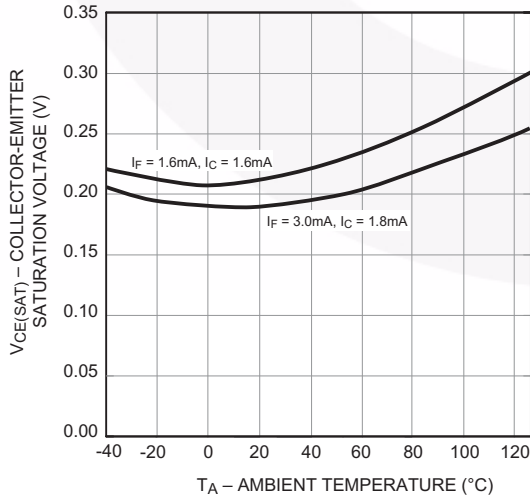
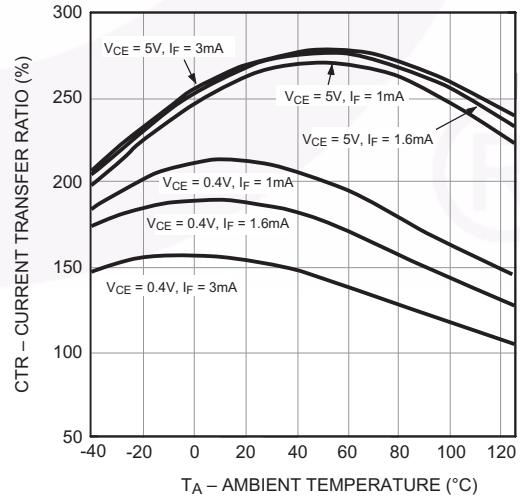

Fig. 12 Current Transfer Ratio vs. Ambient Temperature



Test Circuits

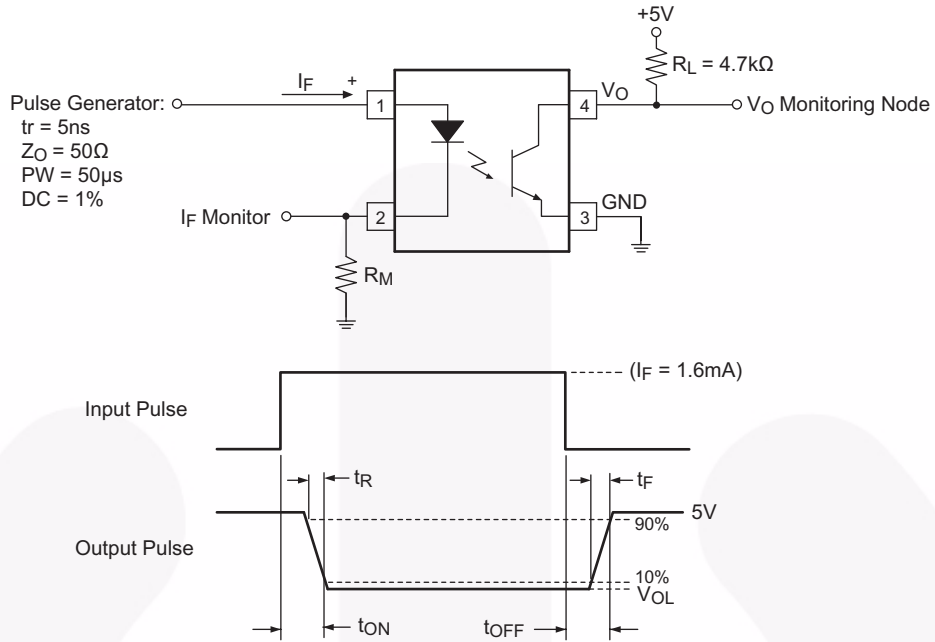

Figure 13. Test Circuit for Propagation Delay Time, Rise Time and Fall Time

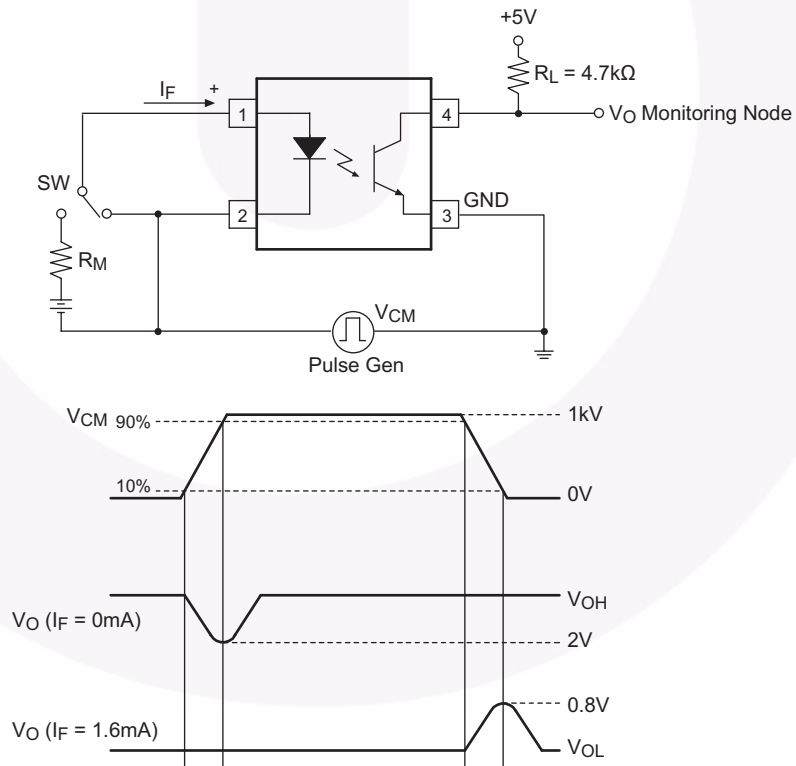
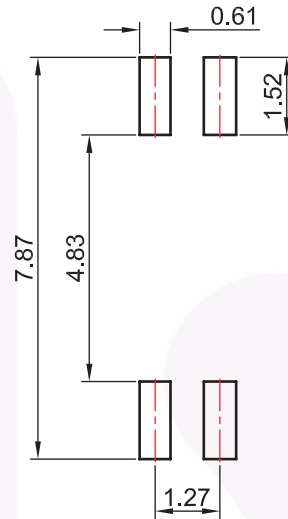
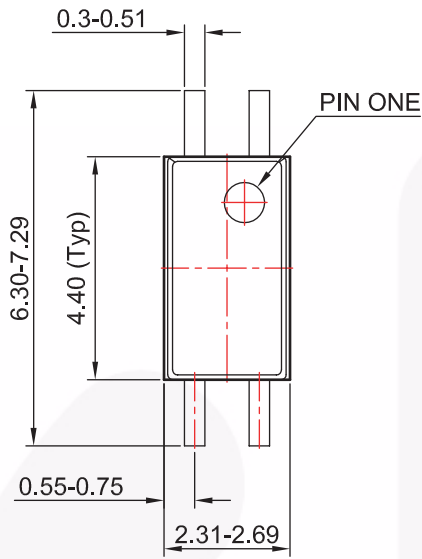
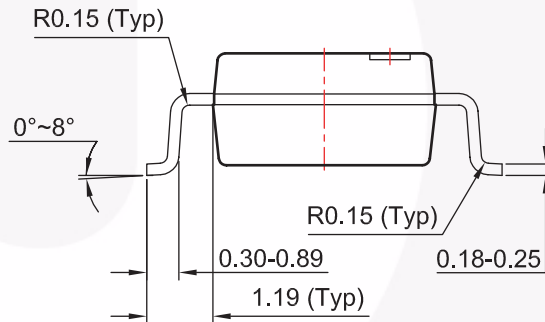
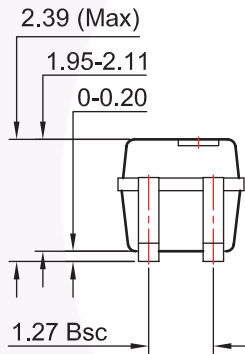

Figure 14. Test Circuit for Instantaneous Common Mode Rejection Voltage

Package Dimensions



LAND PATTERN RECOMMENDATION



Note:
All dimensions are in millimeters.

Package drawings are provided as a service to customers considering Fairchild components. Drawings may change in any manner without notice. Please note the revision and/or date on the drawing and contact a Fairchild Semiconductor representative to verify or obtain the most recent revision. Package specifications do not expand the terms of Fairchild's worldwide terms and conditions, specifically the warranty therein, which covers Fairchild products.

Always visit Fairchild Semiconductor's online packaging area for the most recent package drawings:
<http://www.fairchildsemi.com/packaging/>

Ordering Information

Part Number	Current Transfer Ratio (CTR %) Option, $I_F = 1\text{mA}$, $V_{CE} = 5\text{V}$
FODM8801A	80% to 160%
FODM8801B	130% to 260%
FODM8801C	200% to 400%
Packing Method	
FODM8801x	Tube (100 units per tube)
FODM8801xR2	Tape and Reel (2500 units per reel)
FODM8801xV	Tube (100 units per tube), DIN/EN IEC60747-5-2 (pending approval)
FODM8801xR2V	Tape and Reel (2500 units per reel), DIN/EN IEC60747-5-2 (pending approval)

 All packages are lead free per JEDEC: J-STD-020B standard.

“x” or “xR2” denotes the Current Transfer Ratio option. For example FODM8801AR2 is a phototransistor with 80% to 160% CTR in tape and reel packaging.

Marking Information

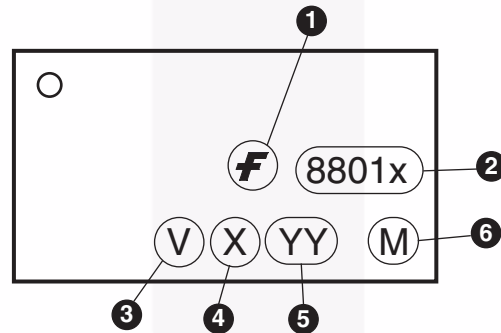

Definitions	
1	Fairchild logo
2	Device number, 'x' denotes CTR% option (A, B or C)
3	VDE mark (Note: Only appears on parts ordered with DIN/EN IEC60747-5-2 option – See order entry table)
4	One digit year code, e.g., '1' represents the year 2011
5	Two digit work week ranging from '01' to '53'
6	Assembly package code

Tape and Reel Dimensions

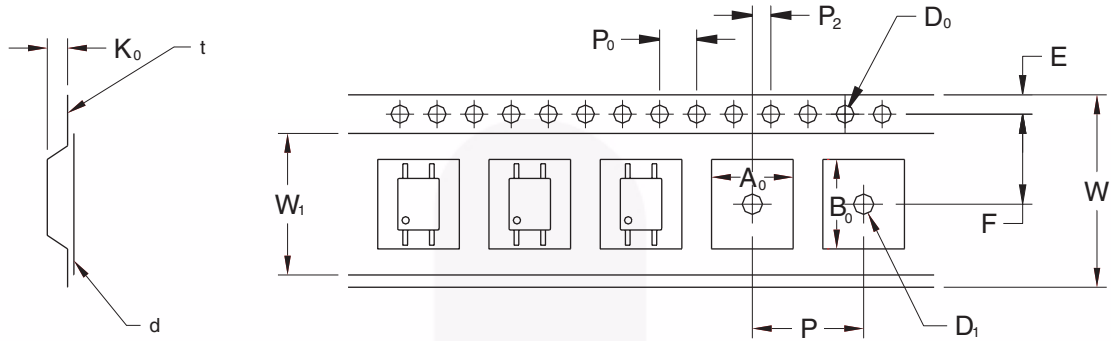

		1.27 Pitch
Description	Symbol	Dimensions (mm)
Tape Width	W	12.00 +0.30/-0.10
Tape Thickness	t	0.30 ±0.05
Sprocket Hole Pitch	P ₀	4.00 ±0.10
Sprocket Hole Diameter	D ₀	1.50 +0.10/-0.0
Sprocket Hole Location	E	1.75 ±0.10
Pocket Location	F	5.50 ±0.10
	P ₂	2.00 ±0.10
Pocket Pitch	P	8.00 ±0.10
Pocket Dimension	A ₀	2.80 ±0.10
	B ₀	7.30 ±0.10
	K ₀	2.30 ±0.10
Pocket Hole Diameter	D ₁	1.50 Min.
Cover Tape Width	W ₁	9.20
Cover Tape Thickness	d	0.065 ±0.010
Max. Component Rotation or Tilt		10° Max.
Devices Per Reel		2500
Reel Diameter		330mm (13")

Reflow Profile

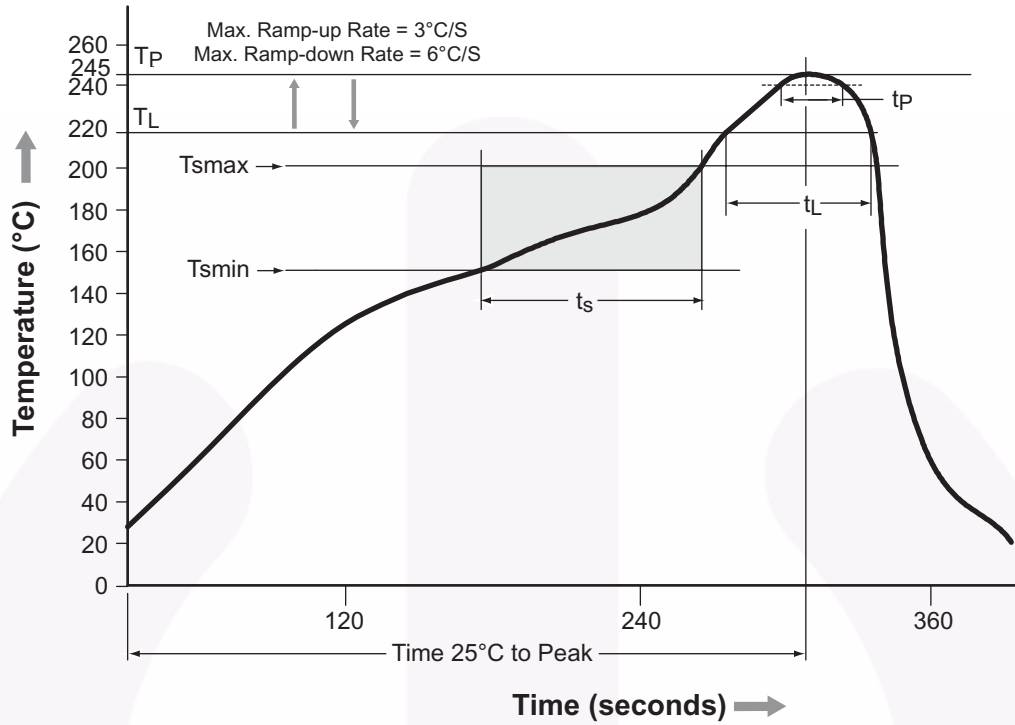





Profile Feature	Pb-Free Assembly Profile
Temperature Min. (T _{min})	150°C
Temperature Max. (T _{max})	200°C
Time (t _s) from (T _{min} to T _{max})	60–120 seconds
Ramp-up Rate (t _L to t _p)	3°C/second max.
Liquidous Temperature (T _L)	217°C
Time (t _L) Maintained Above (T _L)	60–150 seconds
Peak Body Package Temperature	245°C +0°C / -5°C
Time (t _p) within 5°C of 260°C	30 seconds
Ramp-down Rate (T _P to T _L)	6°C/second max.
Time 25°C to Peak Temperature	8 minutes max.



TRADEMARKS

The following includes registered and unregistered trademarks and service marks, owned by Fairchild Semiconductor and/or its global subsidiaries, and is not intended to be an exhaustive list of all such trademarks.

- | | | | |
|---|---|---|---|
| AccuPower™ | FPS™ | Power-SPM™ | The Power Franchise® |
| Auto-SPM™ | F-PFST™ | PowerTrench® | The Right Technology for Your Success™ |
| AX-CAP™ | FRFET® | PowerXS™ |  |
| BitSiC® | Global Power Resource™ | Programmable Active Droop™ | TinyBoost™ |
| Build it Now™ | Green FPS™ | QFET® | TinyBuck™ |
| CorePLUS™ | Green FPS™ e-Series™ | QST™ | TinyCalc™ |
| CorePOWER™ | Gmax™ | Quiet Series™ | TinyLogic® |
| CROSSVOLT™ | GTO™ | RapidConfigure™ | TINYOPTO™ |
| CTL™ | IntelliMAX™ |  | TinyPower™ |
| Current Transfer Logic™ | ISOPLANAR™ | Saving our world, 1mW/WkWh at a time™ | TinyPWM™ |
| DEUXPEED® | MegaBuck™ | SignalWise™ | TinyWire™ |
| Dual Cool™ | MICROCOUPLER™ | SmartMax™ | TranSiC® |
| EcoSPARK® | MicroFET™ | SMART START™ | TriFault Detect™ |
| EfficientMax™ | MicroPak™ | SPM® | TRUECURRENT® |
| ESBC™ | MicroPak2™ | STEALTH™ | μSerDes™ |
|  | MillerDrive™ | SuperFET® |  |
| Fairchild® | MotionMax™ | SuperSOT™.3 | UHC® |
| Fairchild Semiconductor® | Motion-SPM™ | SuperSOT™.6 | Ultra FRFET™ |
| FACT Quiet Series™ | mWSaver™ | SuperSOT™.8 | UniFET™ |
| FACT® | OptoHiT™ | SupreMOS® | VCX™ |
| FAST® | OPTOLOGIC® | SyncFET™ | VisualMax™ |
| FastvCore™ | OPTOPLANAR® | Sync-Lock™ | XS™ |
| FETBench™ |  | | |
| FlashWriter® | PDP SPM™ | | |

* Trademarks of System General Corporation, used under license by Fairchild Semiconductor.

DISCLAIMER

FAIRCHILD SEMICONDUCTOR RESERVES THE RIGHT TO MAKE CHANGES WITHOUT FURTHER NOTICE TO ANY PRODUCTS HEREIN TO IMPROVE RELIABILITY, FUNCTION, OR DESIGN. FAIRCHILD DOES NOT ASSUME ANY LIABILITY ARISING OUT OF THE APPLICATION OR USE OF ANY PRODUCT OR CIRCUIT DESCRIBED HEREIN; NEITHER DOES IT CONVEY ANY LICENSE UNDER ITS PATENT RIGHTS, NOR THE RIGHTS OF OTHERS. THESE SPECIFICATIONS DO NOT EXPAND THE TERMS OF FAIRCHILD'S WORLDWIDE TERMS AND CONDITIONS, SPECIFICALLY THE WARRANTY THEREIN, WHICH COVERS THESE PRODUCTS.

LIFE SUPPORT POLICY

FAIRCHILD'S PRODUCTS ARE NOT AUTHORIZED FOR USE AS CRITICAL COMPONENTS IN LIFE SUPPORT DEVICES OR SYSTEMS WITHOUT THE EXPRESS WRITTEN APPROVAL OF FAIRCHILD SEMICONDUCTOR CORPORATION.

As used herein:

- Life support devices or systems are devices or systems which, (a) are intended for surgical implant into the body or (b) support or sustain life, and (c) whose failure to perform when properly used in accordance with instructions for use provided in the labeling, can be reasonably expected to result in a significant injury of the user.
- A critical component in any component of a life support, device, or system whose failure to perform can be reasonably expected to cause the failure of the life support device or system, or to affect its safety or effectiveness.

ANTI-COUNTERFEITING POLICY

Fairchild Semiconductor Corporation's Anti-Counterfeiting Policy. Fairchild's Anti-Counterfeiting Policy is also stated on our external website, www.fairchildsemi.com, under Sales Support.

Counterfeiting of semiconductor parts is a growing problem in the industry. All manufacturers of semiconductor products are experiencing counterfeiting of their parts. Customers who inadvertently purchase counterfeit parts experience many problems such as loss of brand reputation, substandard performance, failed applications, and increased cost of production and manufacturing delays. Fairchild is taking strong measures to protect ourselves and our customers from the proliferation of counterfeit parts. Fairchild strongly encourages customers to purchase Fairchild parts either directly from Fairchild or from Authorized Fairchild Distributors who are listed by country on our web page cited above. Products customers buy either from Fairchild directly or from Authorized Fairchild Distributors are genuine parts, have full traceability, meet Fairchild's quality standards for handling and storage and provide access to Fairchild's full range of up-to-date technical and product information. Fairchild and our Authorized Distributors will stand behind all warranties and will appropriately address any warranty issues that may arise. Fairchild will not provide any warranty coverage or other assistance for parts bought from Unauthorized Sources. Fairchild is committed to combat this global problem and encourage our customers to do their part in stopping this practice by buying direct or from authorized distributors.

PRODUCT STATUS DEFINITIONS

Definition of Terms

Datasheet Identification	Product Status	Definition
Advance Information	Formative / In Design	Datasheet contains the design specifications for product development. Specifications may change in any manner without notice.
Preliminary	First Production	Datasheet contains preliminary data; supplementary data will be published at a later date. Fairchild Semiconductor reserves the right to make changes at any time without notice to improve design.
No Identification Needed	Full Production	Datasheet contains final specifications. Fairchild Semiconductor reserves the right to make changes at any time without notice to improve the design.
Obsolete	Not In Production	Datasheet contains specifications on a product that is discontinued by Fairchild Semiconductor. The datasheet is for reference information only.

Rev. I54