

UNIPAC OPTOELECTRONICS CORPORATION

Spec. No. 413-210-088

Version : 0



Total pages : 19

Date : 1999.11.01

UP056D01 COLOR TFT-LCD PRELIMINARY SPECIFICATION

MODEL NAME: UP056D01

The content of this technical information is subject to change without notice. Please contact Unipac or its agent for further information.

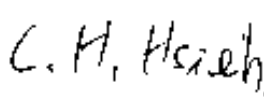
Approved by	Checked by	Prepared by
		

Contents:

- A. Physical specification..... P3**
- B. Electrical specifications..... P4**
 - 1. Pin assignment..... P4
 - a. TFT-LCD panel driving section..... P4
 - b. Backlight driving section..... P5
 - 2. Absolute maximum ratings..... P5
 - 3. Electrical characteristics..... P6
 - a. Typical operating conditions..... P6
 - b. Current consumption..... P6
 - c. Backlight driving conditions..... P6
 - 4. AC Timing..... P7
 - a. Timing conditions..... P7
 - b. Timing diagram..... P7
- C. Optical specifications..... P8**
- D. Reliability test items..... P10**
- E. Packing form..... P11**

Appendix:

Fig.1 Outline dimension of TFT-LCD module. **P12**
Fig.2 Sampling clock timing. **P13**
Fig.3 Horizontal display timing range. **P14**
Fig.4-(a) Horizontal timing. **P15**
Fig.4-(b) Detail horizontal timing. **P16**
Fig.5 Vertical shift clock timing. **P17**
Fig.6-(a) Vertical timing (From up to down). **P18**
Fig.6-(b) Vertical timing (From down to up) **P19**

The numbers with parenthesis in the following specification are the estimated values, please contact Unipac or its agent for the updated information.

A. Physical specifications

NO.	Item	Specification	Remark
1	Display resolution(dot)	960(W) × 234(H)	
2	Active area(mm)	113.3(W) × 84.7(H)	
3	Screen size(inch)	5.6(Diagonal)	
4	Dot pitch(mm)	0.118(W) × 0.362(H)	
5	Color configuration	R. G. B. stripe	
6	Overall dimension(mm)	126.5(W) × 100(H) × (6.8)(D)	Note 1
7	Weight(g)	(180 ± 20)	

Note 1: Refer to Fig. 1

B. Electrical specifications

1.Pin assignment

a. TFT-LCD panel driving section

Pin no	Symbol	I/O	Description	Remark
1	GND	-	Ground for logic circuit	
2	V _{CC}	I	Supply voltage of logic control circuit for scan driver	
3	V _{GL}	I	Negative power for scan driver	
4	V _{GH}	I	Positive power for scan driver	
5	STVR	I/o	Vertical start pulse	Note 1
6	STVL	I/o	Vertical start pulse	Note 1
7	CKV	I	Shift clock input for scan driver	
8	U/D	I	UP/DOWN scan control input	Note 1,2
9	OEV	I	Output enable input for scan driver	
10	VCOM	I	Common electrode driving signal	
11	VCOM	I	Common electrode driving signal	
12	L/R	I	LEFT/RIGHT scan control input	Note 1,2
13	Q1H	I	Analog signal rotate input	
14	OEH	I	Output enable input for data driver	
15	STHL	I/o	Start pulse for horizontal scan line	Note 1
16	STHR	I/o	Start pulse for horizontal scan line	Note 1
17	CPH3	I	Sampling and shifting clock pulse for data driver	
18	CPH2	I	Sampling and shifting clock pulse for data driver	
19	CPH1	I	Sampling and shifting clock pulse for data driver	
20	V _{CC}	I	Supply voltage of logic control circuit for data driver	
21	GND	-	Ground for logic circuit	
22	VR	I	Alternated video signal input(Red)	
23	VG	I	Alternated video signal input(Green)	
24	VB	I	Alternated video signal input(Blue)	
25	AV _{DD}	I	Supply voltage for analog circuit	
26	AV _{SS}	-	Ground for analog circuit	

Note 1: Selection of scanning mode (please refer to the following table)

Setting of scan control input		IN/OUT state For start pulse				Scanning direction
U/D	L/R	STVR	STVL	STHR	STHL	
GND	V _{CC}	OUT	IN	OUT	IN	From up to down, and from left to right.
V _{CC}	GND	IN	OUT	IN	OUT	From down to up, and from right to left.
GND	GND	OUT	IN	IN	OUT	From up to down, and from right to left.
V _{CC}	V _{CC}	IN	OUT	OUT	IN	From down to up, and from left to right.

IN: Input; OUT: Output.

Note 2 : Definition of scanning direction.

Refer to figure as below:

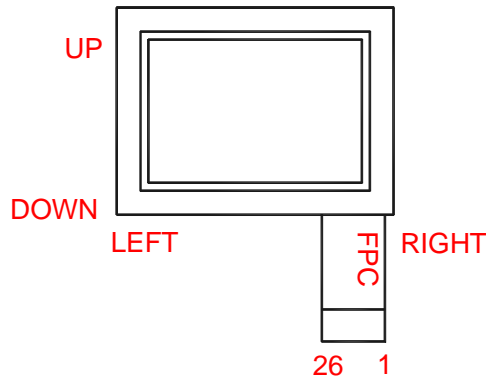

b. Backlight driving section(Refer to Fig. 1)

No.	Symbol	I/O	Description	Remark
1	HI	i	Power supply for backlight unit (High voltage)	
2	GND	-	Ground for backlight unit	

2. Absolute maximum ratings

Item	Symbol	Condition	Min.	Max.	Unit	Remark
Power voltage	V _{CC}	GND=0	-0.3	7	V	
	AV _{DD}	AV _{SS} =0	-0.3	7	V	
	V _{GH}	GND=0	-0.3	18	V	
	V _{GL}		-15	0.3	V	
	V _{GH} -V _{GL}		-	31	V	
Input signal voltage	V _i		-0.3	AV _{DD} +0.3	V	Note 1
	V _I		-0.3	V _{CC} +0.3	V	Note 2
	V _{COM}		-2.9	5.2	V	
Operating temperature	Topa		0	60	°C	Ambient temperature
Storage temperature	Tstg		-25	80	°C	Ambient temperature

Note 1: VR, VG, VB

Note 2: STHL, STHR, Q1H,OEH,L/R,CPH1~CPH3, STVR, STVL,OEV,CKV,U/D.

3. Electrical characteristics

a. Typical operating conditions (GND=AVss=0V, Note 5)

Item	Symbol	Min.	Typ.	Max.	Unit	Remark
Power supply	V_{CC}	4.8	5	5.2	V	
	AV_{DD}	4.8	5	5.2	V	
	V_{GH}	14.3	15	15.7	V	
	V_{GLAC}	-	(5)	-	Vp-p	AC component of V_{GL} . Note 1
	V_{GLDC}	-10.5	-10	-9.5	V	DC component of V_{GL} .
Video signal Amplitude (VR, VG, VB)	V_{iA}	AVss +0.4	-	$AV_{DD}-0.4$	V	Note 2
	V_{iAC}	-	3	-	V	AC component
	V_{iDC}	-	$AV_{DD}/2$	-	V	DC component
VCOM	V_{CAC}	-	(5)	-	Vp-p	AC component, Note 3
	V_{CDC}	TBD	TBD	TBD	V	DC component
Input Signal voltage	H Level	V_{IH}	$0.8V_{CC}$	-	V_{CC}	Note 4
	L Level	V_{IL}	0	-	$0.2V_{CC}$	

Note 1: The same phase and amplitude with common electrode driving signal(VCOM).

Note 2: Refer to Fig.4-(a)

Note 3: The brightness of LCD panel could be adjusted by the adjustment of the AC component of VCOM.

Note 4: STHL, STHR, Q1H, OEH, L/R, CPH1~CPH3, STVR, STVL, OEV, CKV, U/D.

Note 5: Be sure to apply GND, V_{CC} and V_{GL} to the LCD first, and then apply V_{GH} .

b. Current consumption (GND=AVss=0V)

Parameter	Symbol	Condition	Min.	Typ.	Max.	Unit	Remark
Current for driver	I_{GH}	$V_{GH}=15V$	-	(0.26)	(0.8)	mA	
	I_{GL}	$V_{GL}=-10V$	-	(-0.41)	(-1)	mA	
	I_{CC}	$V_{CC}=5V$	-	(6.5)	(12)	mA	
	I_{DD}	$AV_{DD}=5V$	-	(10)	(20)	mA	
	I_{VCOM}	$V_{CAC}=5V$	-	TBD	TBD	mA	
	I_{LI1}	-	-10	-	10	μA	Note 1

Note 1: Logic Input Leakage Current

c. Backlight driving conditions

Parameter	Symbol	Min.	Typ.	Max.	Unit	Remark
Lamp voltage	V_L	TBD	(580)	(638)	Vrms	Note 3
Lamp current	I_L	(5)	6	(7)	mArms	
Frequency	F_L	-	60	-	kHz	Note 3,4
Lamp starting voltage	V_S	-	(930)	(1150)	Vrms	Note 1,3,5
		-	(1100)	(1150)	Vrms	Note 2,3,5

Note 1: $T_a = 25^\circ C$.

Note 2: $T_a = 0^\circ C$.

Note 3: Reference value, correct value is subject to final backlight specification which will be decided in the future.

Note 4: The lamp frequency should be selected as different as possible from display horizontal synchronous signal to avoid interference.

Note 5: For starting the backlight unit, the output voltage of DC/AC's transformer should be larger than the maximum lamp starting voltage.

4. AC Timing

a. Timing conditions

Parameter	Symbol	Min.	Typ.	Max.	Unit.	Remark
Rising time	t_{r1}	-	-	60	ns	CPH1~CPH3
Falling time	t_{f1}	-	-	60	ns	CPH1~CPH3
Rising time	t_{r2}	-	-	120	ns	CKV
Falling time	t_{f2}	-	-	120	ns	CKV
High and low level pulse width	t_{CPH}	150	154	158	ns	CPH1~CPH3
CPH pulse duty	t_{CWH}	40	50	60	%	CPH1~CPH3
CPH pulse delay	t_{C12} t_{C23} t_{C31}	30	$t_{CPH}/3$	$t_{CPH}/2$	ns	CPH1~CPH3
STH setup time	t_{SUH}	20	-	-	ns	STHR,STHL
STH hold time	t_{HDH}	20	-	-	ns	STHR,STHL
STH pulse width	t_{STH}	-	1	-	t_{CPH}	STHR,STHL
STH period	t_H	61.5	63.5	65.5	μs	STHR,STHL
OEH pulse width	t_{OEH}	-	7	-	t_{CPH}	OEH
Sample and hold disable time	t_{DIS1}	-	55	-	t_{CPH}	
OEV pulse width	t_{OEV}	-	27	-	t_{CPH}	OEV
CKV pulse width	t_{CKV}	-	41	-	t_{CPH}	CKV
Clean enable time	t_{DIS2}	-	16	-	t_{CPH}	
Horizontal display start	t_{SH}	-	0	-	$t_{CPH}/3$	
Horizontal display timing range	t_{DH}	-	960	-	$t_{CPH}/3$	
STV setup time	t_{SUV}	400	-	-	ns	STVL,STVR
STV hold time	t_{HDV}	400	-	-	ns	STVL,STVR
STV pulse width	t_{STV}	-	-	1	t_H	STVL,STVR
Horizontal lines per field	t_V	256	262	268	t_H	Note 1
Vertical display start	t_{SV}		3	-	t_H	
Vertical display timing range	t_{DV}		234	-	t_H	
VCOM rising time	t_{rCOM}		-	5	μs	
VCOM falling time	t_{fCOM}		-	5	μs	
VCOM delay time	t_{DCOM}		-	3	μs	
RGB delay time	t_{DRGB}		-	1	μs	

Note 1: Please don't use odd horizontal lines to drive LCD panel for both odd and even field simultaneously.

b. Timing diagram

Please refer to the attached drawing, from Fig.2 to Fig.6.

C. Optical specification (Note 1,Note 2, Note 3)

Item		Symbol	Condition	Min.	Typ.	Max.	Unit	Remark
Response time	Rise	Tr	$\theta = 0^\circ$	-	15	30	Ms	Note 4,6
	Fall	Tf		-	20	40	Ms	
Contrast ratio		CR	At optimized viewing angle	100	150	-		Note 5,6
Viewing angle	Top		$CR \geq 10$	10	-	-	deg.	Note 6,7
	Bottom			30	-	-		
	Left			45	-	-		
	Right			45	-	-		
Brightness			$\theta = 0^\circ$	250	300	-	nit	Note 8
White chromaticity		X	$\theta = 0^\circ$	0.25	0.30	0.35		Note 8
		Y	$\theta = 0^\circ$	0.30	0.35	0.40		

Note 1. Ambient temperature =25°C . And lamp current $I_L = (6)mArms$.

Note 2. To be measured in the dark room.

Note 3.To be measured on the center area of panel with a viewing cone of 1° by Topcon luminance meter BM-7, after 10 minutes operation.

Note 4. Definition of response time:

The output signals of photodetector are measured when the input signals are changed from “black” to “white”(falling time)and from “white” to “black”(rising time),respectively.

The response time is defined as the time interval between the 10% and 90% of amplitudes. Refer to figure as below.

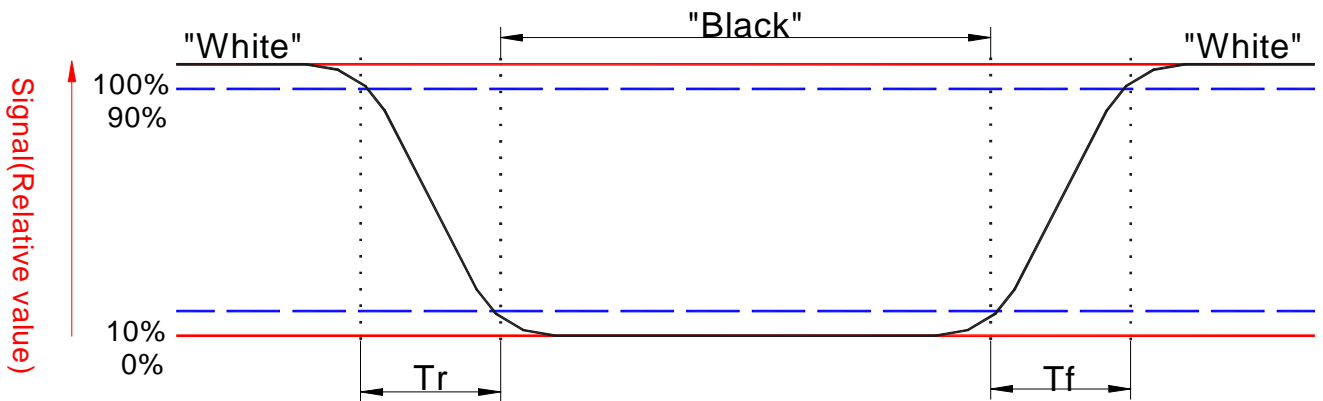

Note 5. Definition of contrast ratio:

Contrast ratio is calculated with the following formula.

$$\text{Contrast ratio (CR)} = \frac{\text{Photodetector output when LCD is at "White" state}}{\text{Photodetector output when LCD is at "Black" state}}$$

Note 6. White $V_i = V_{i50} \mp 1.5V$

Black $V_i = V_{i50} \pm 2.0V$

“ \pm ” means that the analog input signal swings in phase with COM signal.

“ \mp ” means that the analog input signal swings out of phase with COM signal.

V_{i50} : The analog input voltage when transmission is 50%

The 100% transmission is defined as the transmission of LCD panel when all the input terminals of module are electrically opened.

Note 7. Definition of viewing angle:

Refer to figure as below.

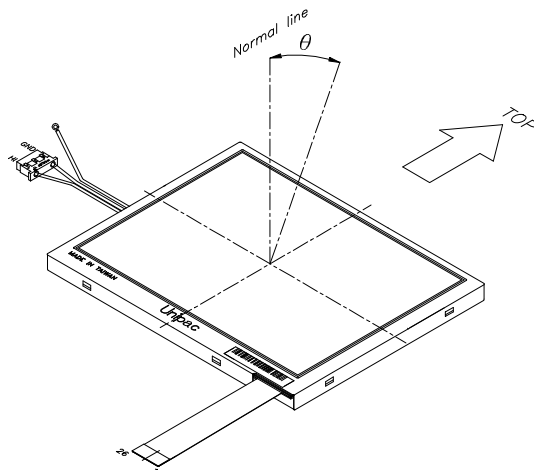

Note 8. Measured at the center area of the panel when all the input terminals of LCD panel are electrically opened.

D. Reliability test items:

No.	Test items	Conditions	Remark
1	High temperature storage	Ta= 80°C 240H	
2	Low temperature storage	Ta= -25°C 240H	
3	High temperature operation	Ta= 60°C 240H	
4	Low temperature operation	Ta= 0°C 240H	
5	High temperature and high humidity	Ta= 60°C, 95% RH 240H	Operation
6	Heat shock	-25°C~80°C/50 cycle 2H/cycle	Non-operation
7	Electrostatic discharge	±200V,200pF(0Ω), once for each terminal	Non-operation
8	Vibration	Frequency range : 10~55Hz Stoke : 1.5mm Sweep : 10~55Hz~10Hz 2 hours for each direction of X,Y,Z (6 hours for total)	JIS C7021, A-10 condition A
9	Mechanical shock	100G , 6ms, ±X,±Y,±Z 3 times for each direction	JIS C7021, A-7 condition C
10	Vibration (with carton)	Random vibration: 0.015G ² /Hz from 5~200Hz -6dB/Octave from 200~500Hz	IEC 68-34
11	Drop (with carton)	Height: (60)cm 1 corner, 3 edges, 6 surfaces	JIS Z0202

Note: Ta: Ambient temperature.

E.Packing form

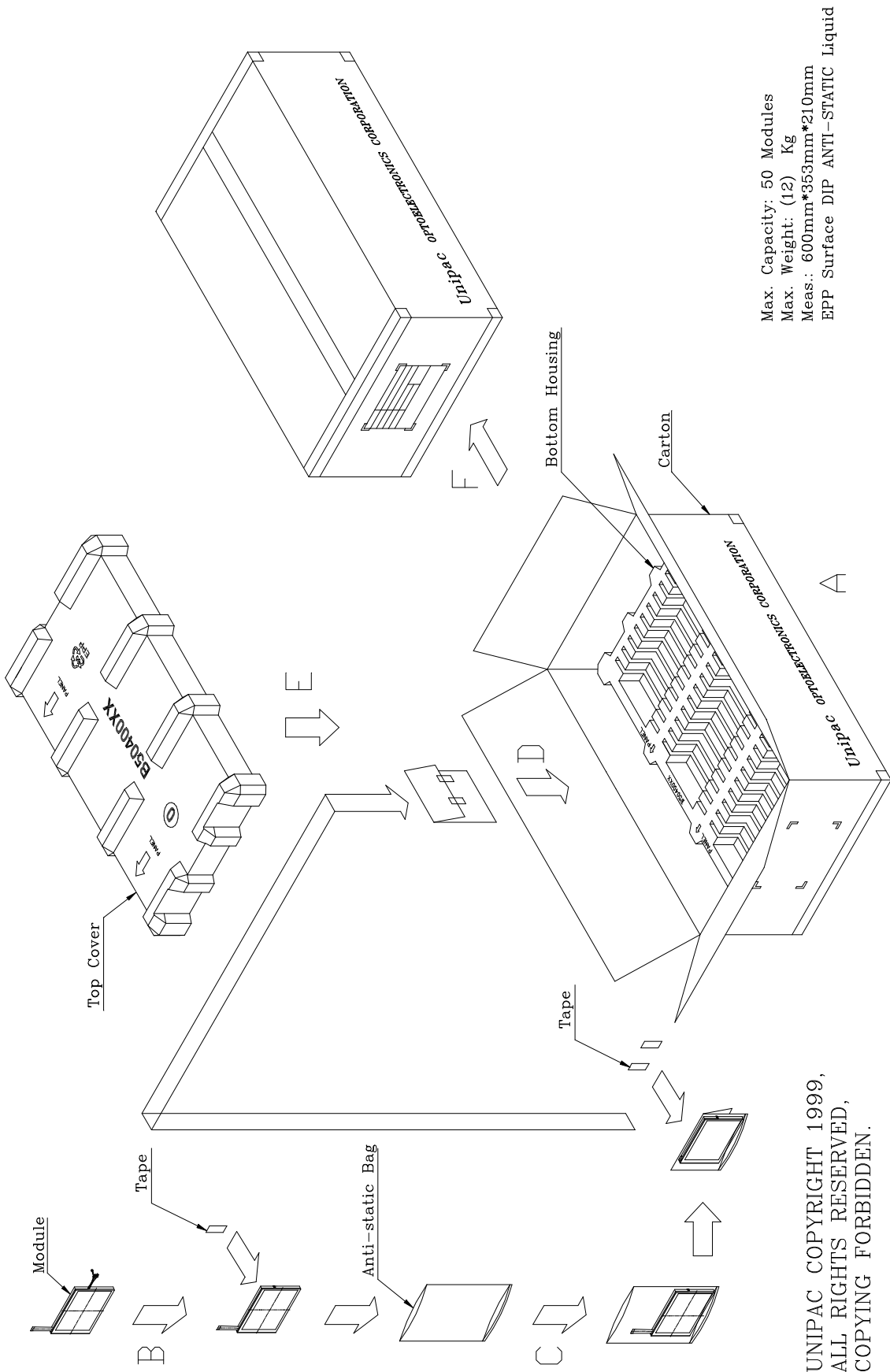

Max. Capacity: 50 Modules
Max. Weight: (12) Kg
Meas.: 600mm*353mm*210mm
EPP Surface DIP ANTI-STATIC Liquid

UNIPAC COPYRIGHT 1999,
ALL RIGHTS RESERVED,
COPYING FORBIDDEN.

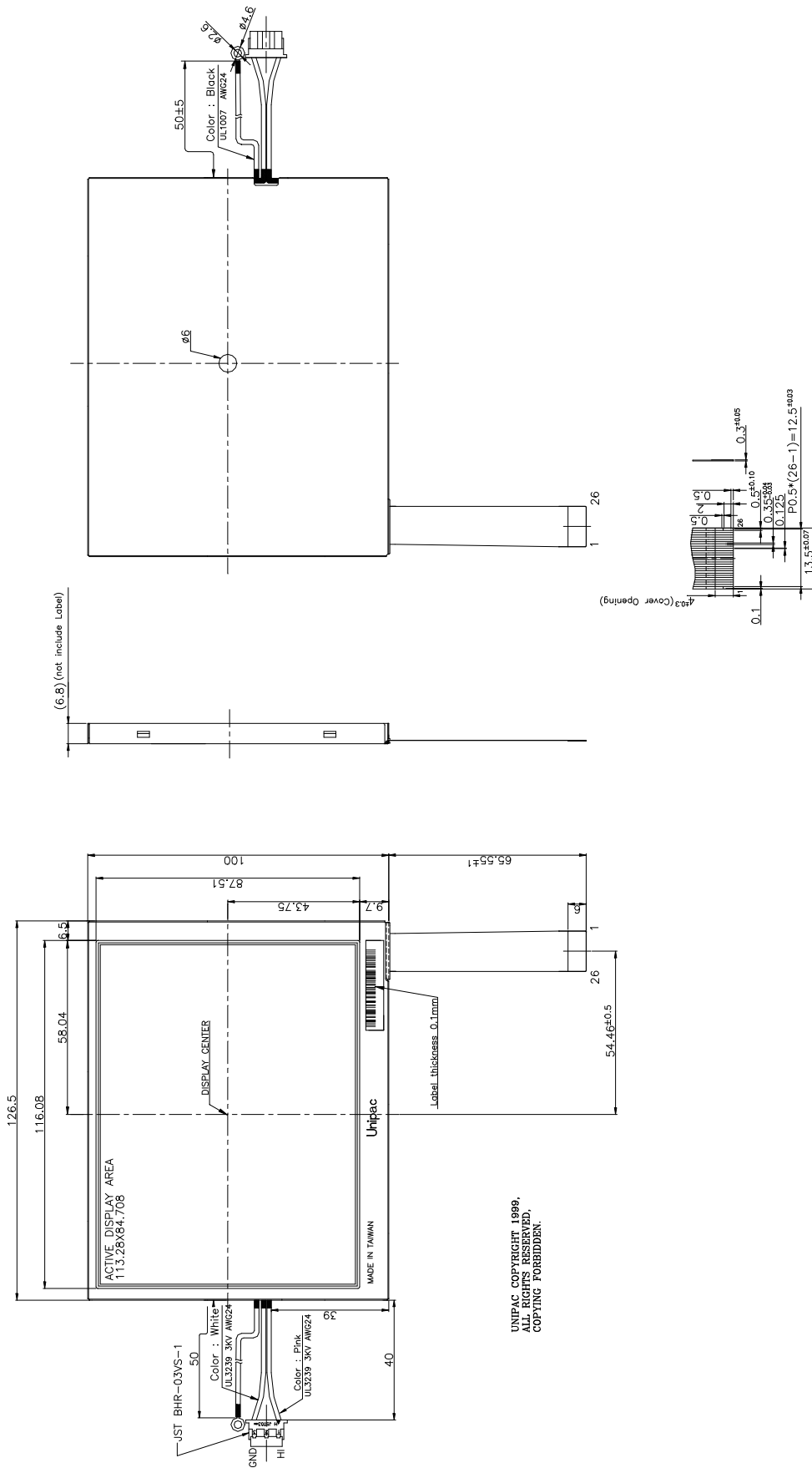

Fig. 1 Outline dimensio of TFT-LCD module

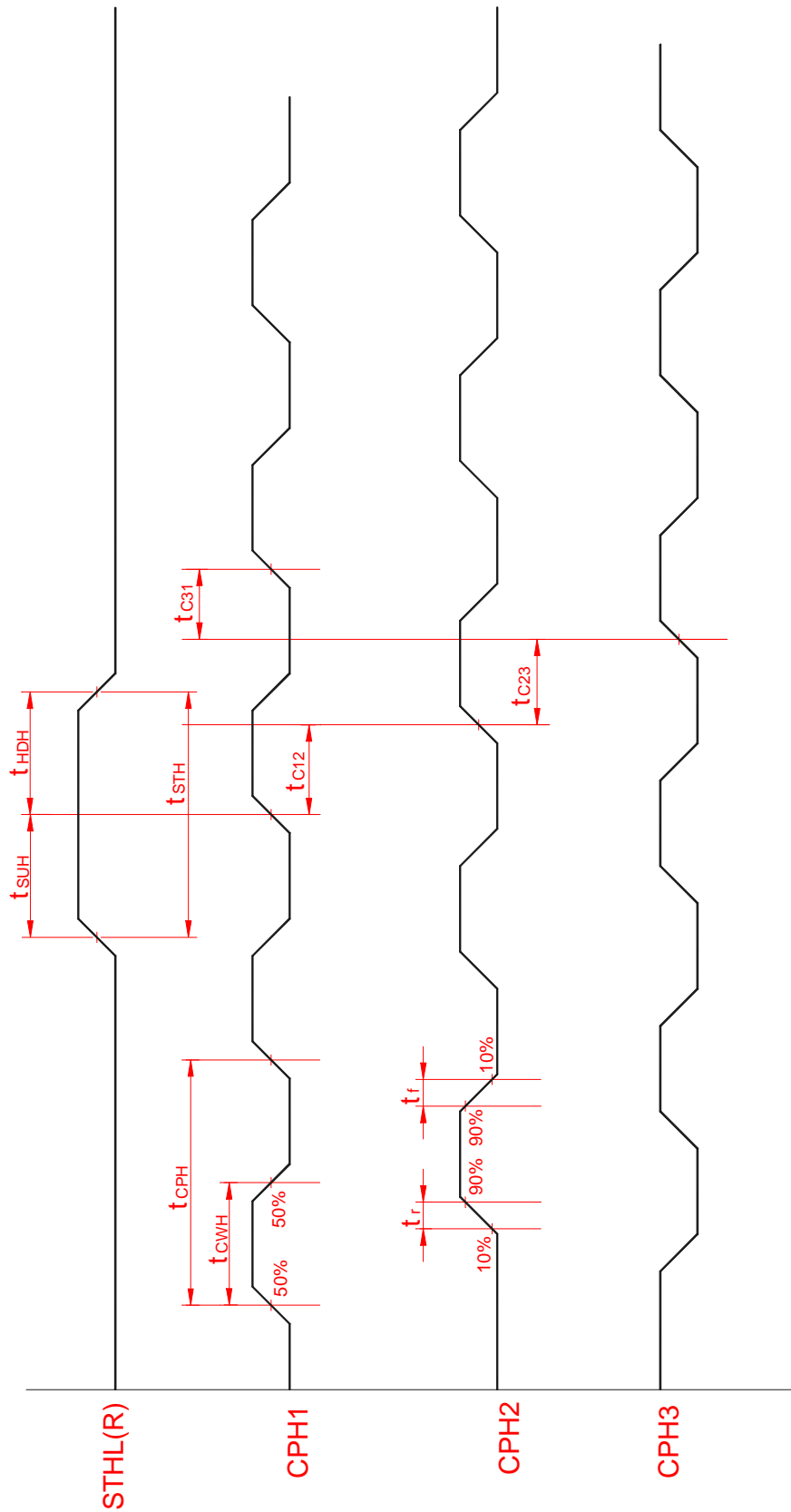

Fig. 2 Sampling clock timing

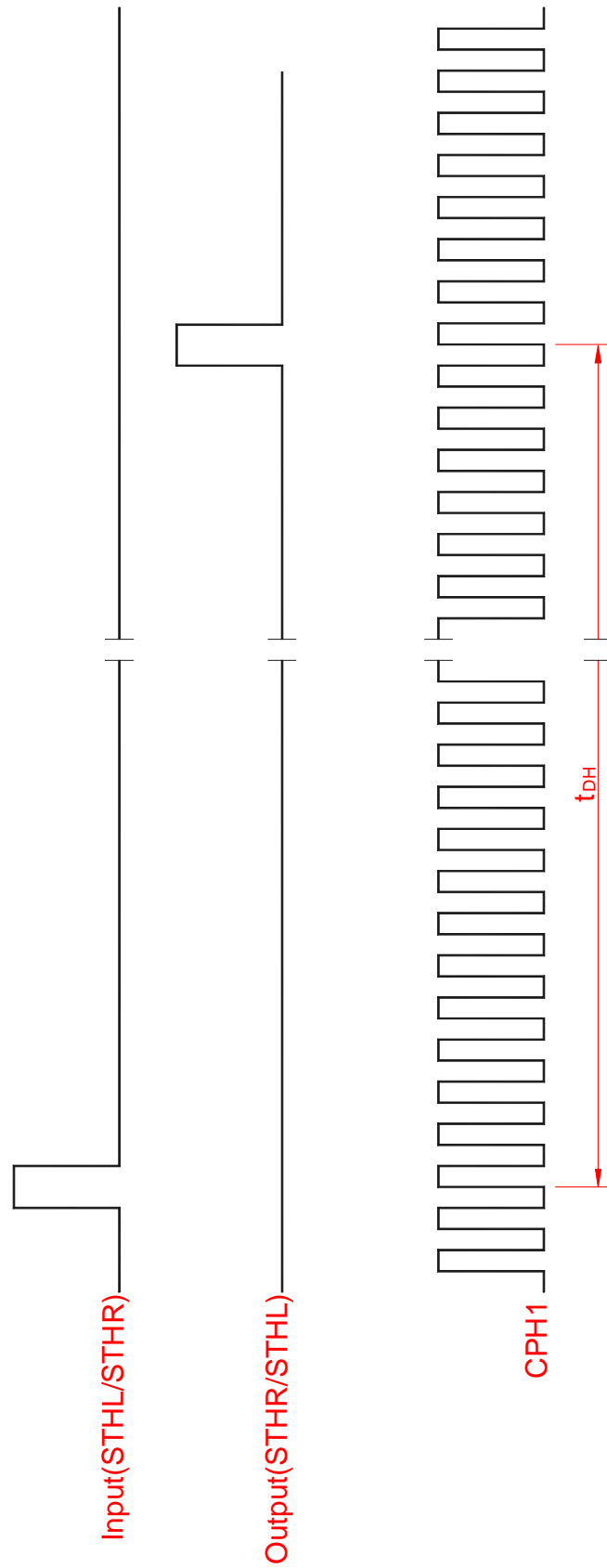

Fig. 3 Horizontal display timing range

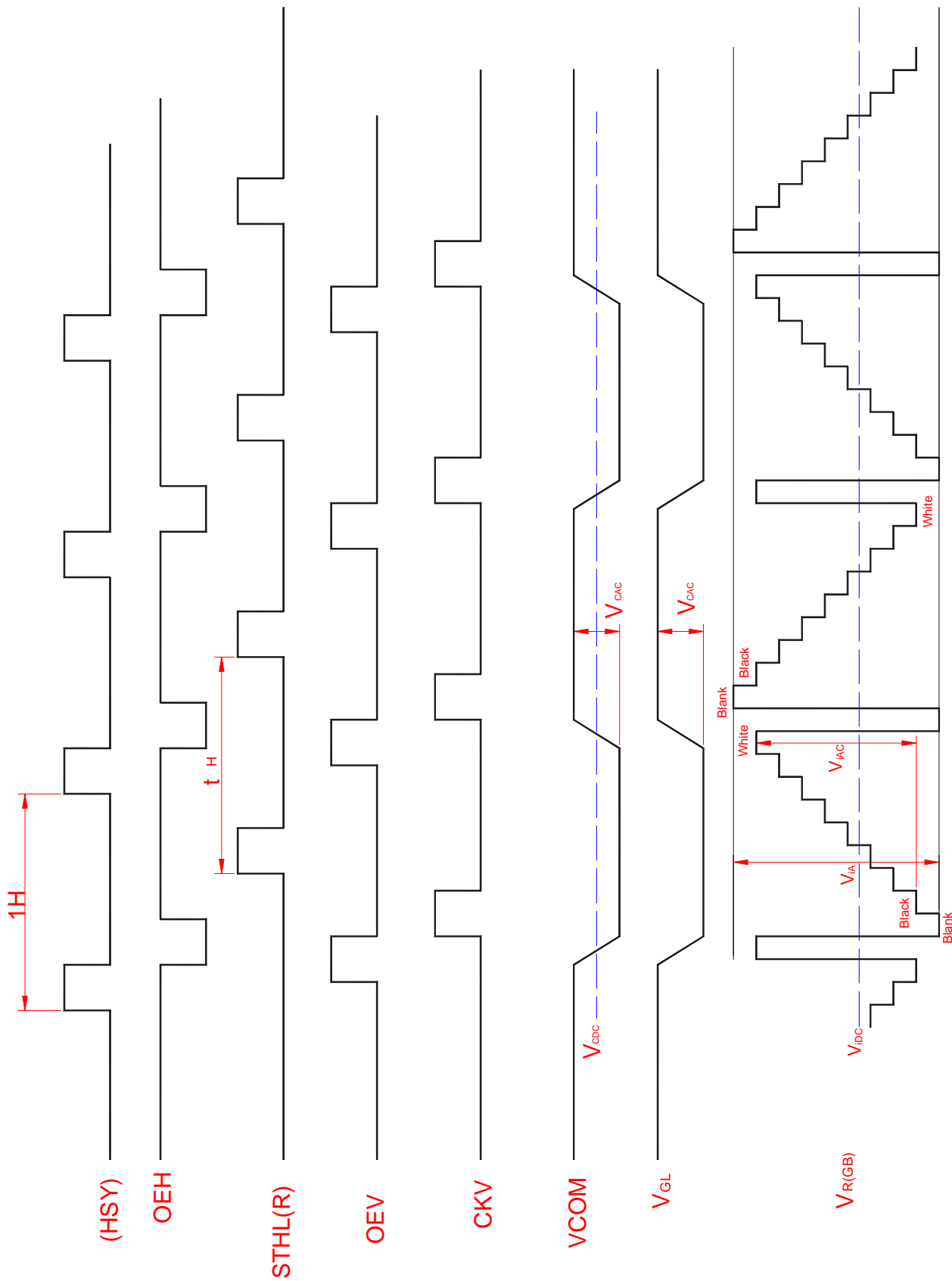
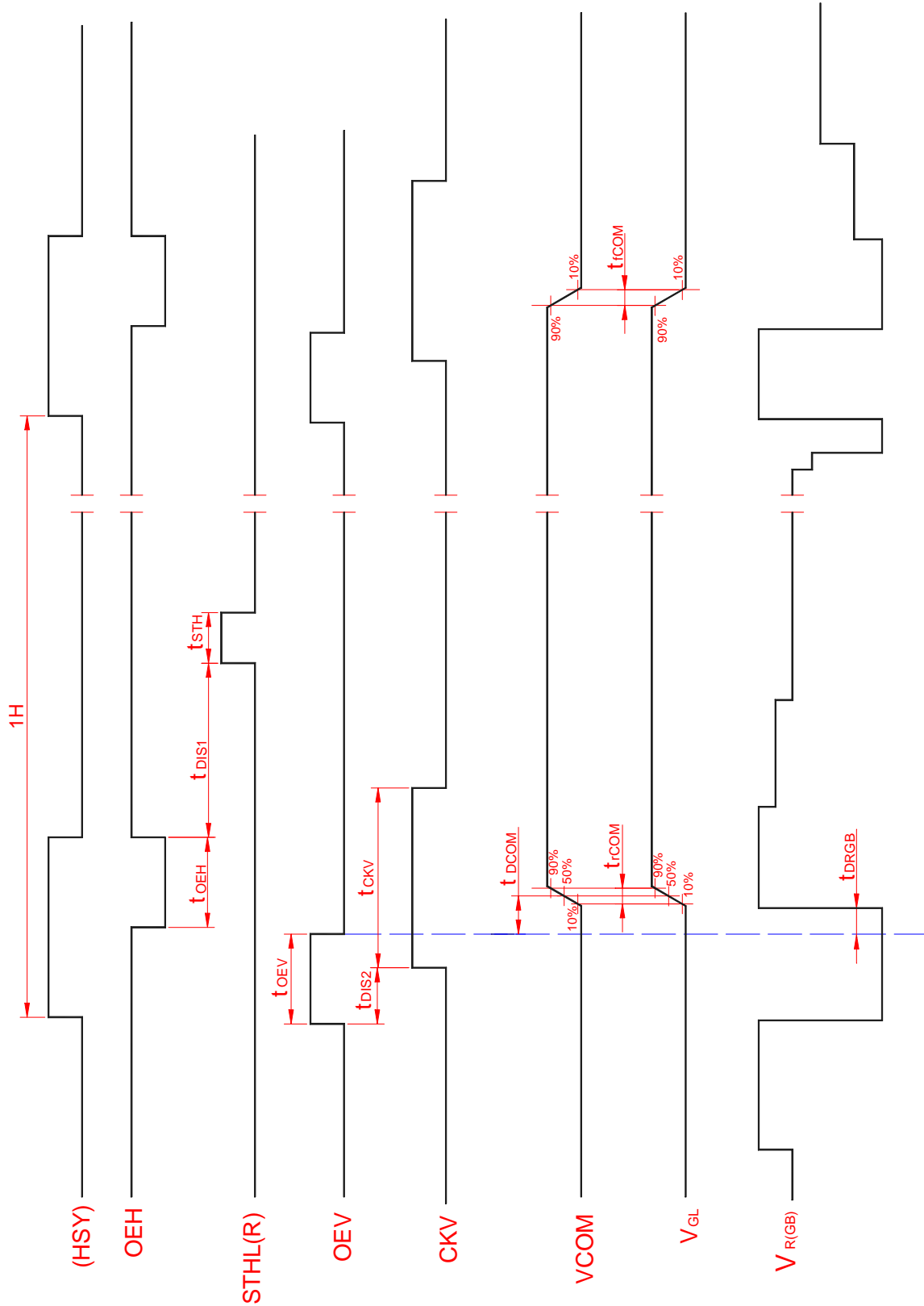

Fig.4-(a) Horizontal timing



Note: The falling edge of OEV should be synchronized with the falling edge of OEH

Fig. 4-(b) Detail horizontal timing

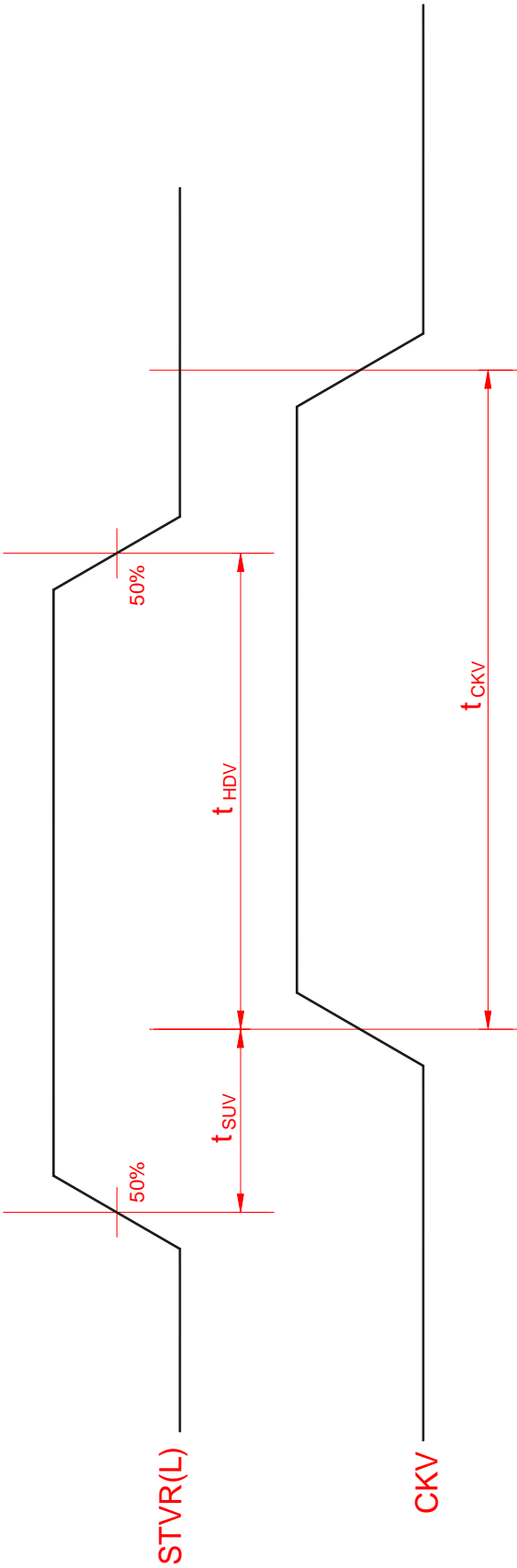

Fig.5 Vertical shift clock timing

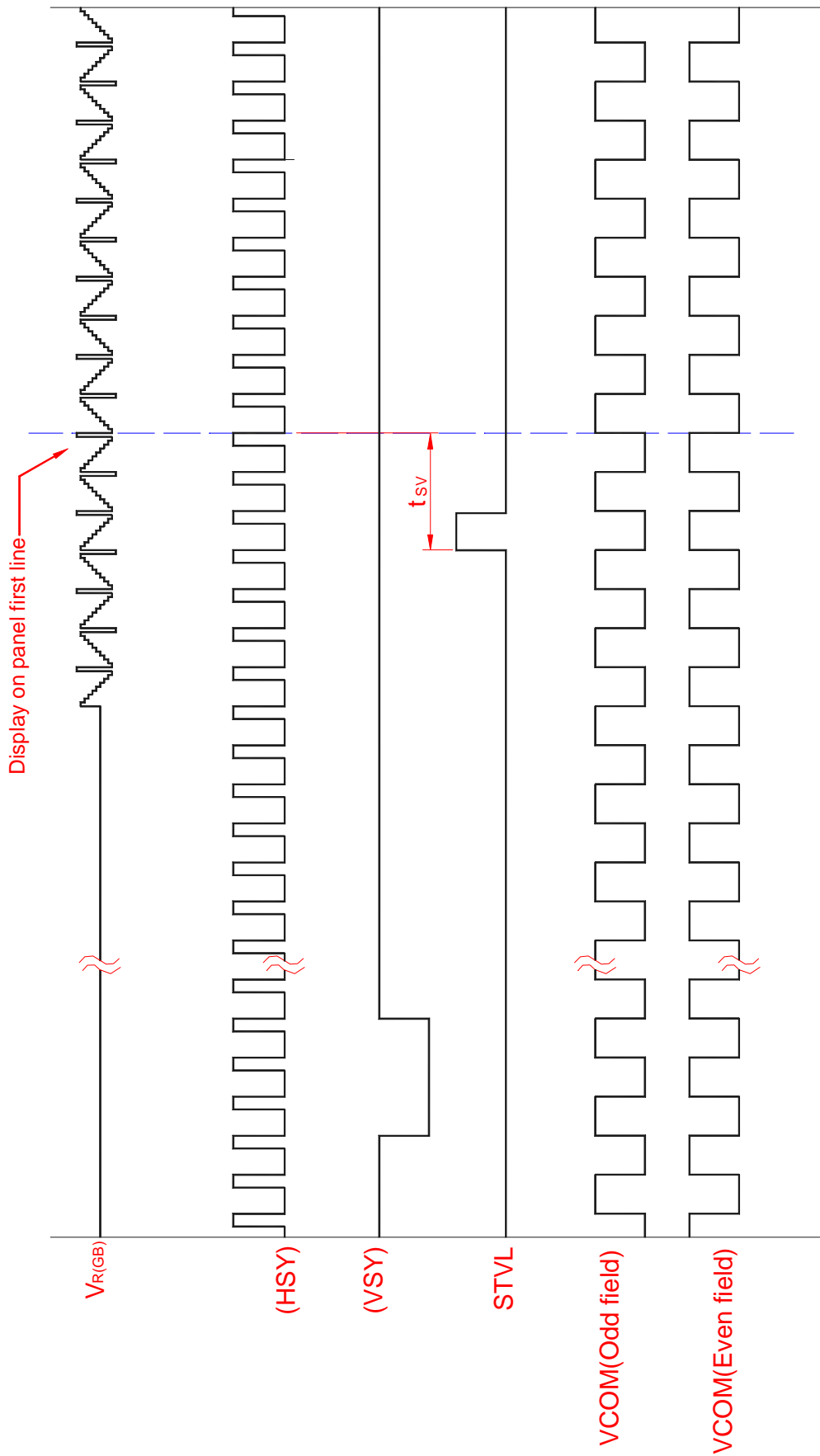

Fig.6-(a) Vertical timing (From up to down)

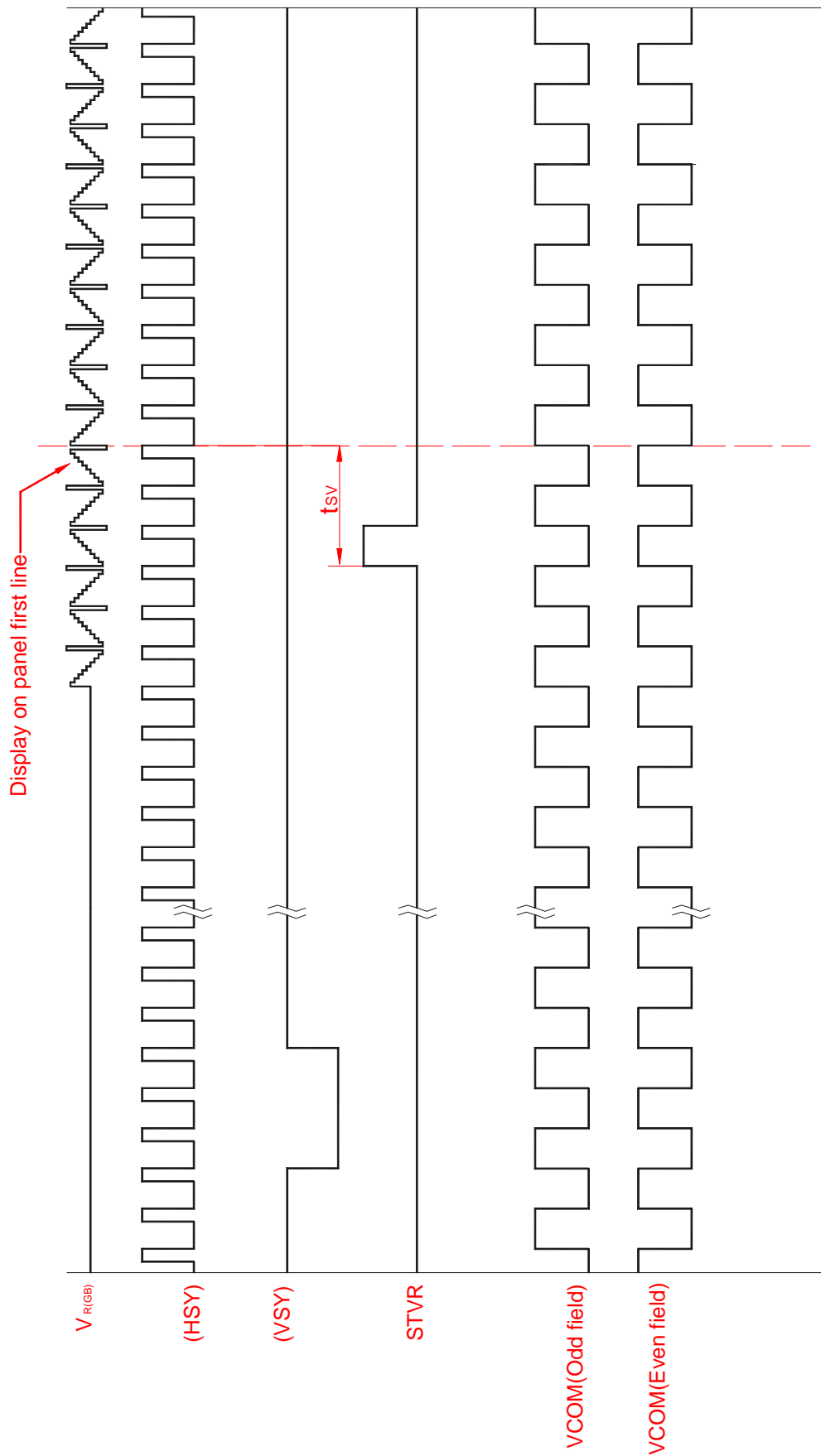

Fig.6-(b) Vertical timing (From down to up)

UNIPAC OPTOELECTRONICS CORPORATION

TERMS AND CONDITIONS OF SALE

These Terms and Conditions of Sale apply to all items designed and/or made by Unipac Optoelectronics Corporation ("Unipac"), and Buyer agrees they apply to all such items.

1 ACCEPTANCE OF TERMS. BUYER ACCEPTS THESE TERMS (i) BY WRITTEN ACCEPTANCE (BY PURCHASE ORDER OR OTHERWISE), OR (ii) BY FAILURE TO RETURN GOODS SUPPLIED BY UNIPAC WITHIN 5 DAYS OF THEIR DELIVERY.

2 DELIVERY

2.1 Delivery will be made Free Carrier (Incoterms 1990), Unipac's warehouse, Science-Based Industrial Park, Taiwan to a carrier designated in writing by Buyer, or if Buyer fails to designate a carrier, to a carrier designated by Unipac.

2.2 Title to the goods and the entire risk will pass to Buyer upon delivery to carrier.

2.3 Shipments are subject to availability. Unipac shall make every reasonable effort to meet the date(s) quoted or acknowledged; and if Unipac makes such effort, UNIPAC WILL NOT BE LIABLE FOR ANY DELAYS.

3 TERMS OF PAYMENT

3.1 Unless otherwise stated on Unipac's quotation, all shipments shall be T/T in advance, by Letter of Credit at Sight, or pursuant to agreed prepayment terms. Unipac reserves the right to change credit terms at any time in its sole discretion.

3.2 Buyer guarantees prompt payment of all obligations accrued pursuant to purchase orders issued by Buyer.

4 LIMITED WARRANTY

4.1 Unipac warrants that the goods sold will be free from defects in material and workmanship and comply with Unipac's applicable published specifications for a period of sixty (60) days from the date of Unipac's shipment.

4.2 Goods or parts which have been subject to abuse (including without limitation repeated or extended exposure to conditions at or near the limits of applicable absolute ratings) misuse, accident, alteration, neglect, or unauthorized repair or improper application are not covered by any warranty. No warranty is made with respect to custom products or goods produced to Buyer's specifications (unless specifically stated in writing signed by Unipac). Unipac shall not be responsible for defects or claims caused by acts not performed by Unipac; or by combination of goods with other things.

4.3 No warranty is made with respect to goods used in devices intended for use in applications where failure to perform when properly used can reasonably be expected to result in significant injury (including, without limitation, navigation, aviation, weaponry or nuclear equipment, or for surgical implant or to support or sustain life) and Buyer agrees to indemnify, defend, and hold harmless Unipac from all claims, damages and liabilities arising out of any such uses.

4.4 This Article 4 is the only warranty by Unipac with respect to goods and may not be modified or amended except in writing signed by an authorized officer of Unipac.

4.5 Buyer acknowledges and agrees that it is not relying on any applications, diagrams or circuits contained in any literature, and Buyer will test all parts and applications under extended field and laboratory conditions. Notwithstanding any cross-reference or any statements of compatibility, functionality, interchangeability, and the like, the goods may differ from similar goods from other vendors in performance, function or operation, and in areas not contained in the written specifications, or as to ranges and conditions outside such specifications; and Buyer agrees that there are no warranties and that Unipac is not responsible for such things.

4.6 REGARDLESS OF CAUSE OR REASON FOR DAMAGE (WHETHER ACCIDENT, NEGLIGENCE, OR OTHERWISE) UNIPAC SHALL HAVE NO LIABILITY (DIRECT, CONSEQUENTIAL OR OTHER) FOR, IN CONNECTION WITH OR ARISING FROM PROPERTY FURNISHED FOR USE AT OR LEFT AT UNIPAC; and by delivering or entrusting property to Unipac, Buyer expressly confirms this limitation. Notwithstanding this limitation, Unipac will replace, or pay the reasonable retooling costs to replace, masks damaged or destroyed as a result of Unipac's gross negligence or fault.

4.7 EXCEPT AS PROVIDED ABOVE, UNIPAC MAKES NO WARRANTIES OR CONDITIONS, EXPRESS, IMPLIED, OR STATUTORY; AND UNIPAC EXPRESSLY EXCLUDES AND DISCLAIMS ANY WARRANTY OR CONDITION OF NON-INFRINGEMENT, MERCHANTABILITY OR FITNESS FOR PARTICULAR PURPOSE OR APPLICATION.

5 LIMITATION OF LIABILITY

5.1 Unipac will not be liable for any loss, damage or penalty resulting from causes beyond its reasonable control, including but not limited to delay by others, force majeure, acts of God, material shortage or labor conditions. In any such event, the date(s) for Unipac's performance will be deemed extended for a period equal to any delay resulting.

5.2 THE LIABILITY OF UNIPAC ARISING OUT OF THIS AGREEMENT OR ANY GOODS SOLD WILL BE LIMITED TO REFUND OF THE PURCHASE PRICE OR (WITH UNIPAC'S PRIOR WRITTEN CONSENT) REPAIR OR REPLACEMENT OF PURCHASED GOODS (RETURNED TO UNIPAC FREIGHT PRE-PAID); OR IN THE EVENT OF A FAILURE OR BREACH BY UNIPAC REGARDING DELIVERY, AN AMOUNT EQUAL TO THE TOTAL PURCHASE PRICE OF THE GOODS THAT HAVE NOT BEEN DELIVERED DUE TO SUCH FAILURE.

5.3 Buyer will not return any goods without first obtaining a customer return order number.

5.4 AS A SEPARATE LIMITATION, IN NO EVENT WILL UNIPAC BE LIABLE (i) FOR COSTS OF SUBSTITUTE GOODS, (ii) FOR ANY SPECIAL, CONSEQUENTIAL, INCIDENTAL, RELIANCE OR INDIRECT DAMAGES, OR (iii) FOR LOSS OF USE, OPPORTUNITY, MARKET POTENTIAL, GOODWILL AND/OR PROFIT ON ANY THEORY (CONTRACT, TORT, FROM THIRD PARTY CLAIMS OR OTHERWISE). THESE LIMITATIONS SHALL APPLY NOTWITHSTANDING ANY FAILURE OF ESSENTIAL PURPOSE OR OF ANY FAILURE OR INADEQUACY OF ANY REMEDY.

THIS AGREEMENT STATES THE ONLY AND EXCLUSIVE REMEDY FOR ANY AND ALL CLAIMS MADE AGAINST UNIPAC UNDER ANY AGREEMENT AND/OR WITH RESPECT TO PANELS, COMPONENTS, SERVICES AND/OR GOODS.

5.5 No action or proceeding may be commenced by either party against the other (other than to collect money due for goods delivered or services rendered), whether for breach, indemnification, contribution or otherwise, more than one year after delivery of the goods to the carrier; and no claim may be brought unless the non-claiming party has first been given commercially reasonable notice, a full written explanation of all pertinent details (including copies of all materials), and a good faith opportunity to resolve the matter.

5.6 BUYER EXPRESSLY AGREES TO THE LIMITATIONS OF ARTICLES 5, 8 AND 9 AND TO THEIR REASONABLENESS.

5.7 The exclusions and limitations of Articles 5, 8 and 9 will survive the termination of the applicable Agreements, and shall apply notwithstanding any claim of a failure of any one or more remedies to accomplish their purpose, and THE PARTIES EXPRESSLY WAIVE AND RELINQUISH ANY CONTRARY RIGHTS UNDER ANY AGREEMENT, AND/OR LAW, DECISION, CUSTOM OR PRACTICE.

6 SUBSTITUTIONS AND MODIFICATIONS

Unipac may at any time make substitutions for product ordered which do not materially and adversely affect overall performance with the then current specifications in the typical and intended use. Unipac reserves the right to halt deliveries and shipments and alter specifications and prices without notice. Buyer shall verify that the literature and information is current before purchasing. Other changes to process and/or specifications by Unipac shall be pursuant to Unipac's standard ECN procedures.

7 CANCELLATION

7.1 This Agreement may not be canceled by Buyer except with written consent by Unipac and Buyer's payment of reasonable cancellation charges (including but not be limited to expenses already incurred for labor and material, overhead, commitments made by Unipac, and a reasonable profit).

7.2 In no event will Buyer have rights in partially completed goods.

8 INDEMNIFICATION

8.1 Unipac will, at its own expense, assist Buyer with technical support and information in connection with any claim that any parts as shipped by Unipac under this purchase order infringe any valid, enforceable, unexpired R.O.C. patent, copyright, or trademark, provided however, that Buyer (i) gives immediate written notice to Unipac, (ii) permits Unipac to participate and to defend if Unipac requests to do so, and (iii) gives Unipac all needed information, assistance and authority. However, Unipac will not be responsible for infringements resulting from anything not entirely manufactured by Unipac, or from any combination with products, equipment, or materials not furnished by Unipac. Unipac will have no liability with respect to intellectual property matters arising out of products made to Buyer's specifications, code, or designs.

8.2 Except as expressly stated in this Article 8 or in another writing signed by an authorized officer, Unipac makes no representations and/or warranties with respect to intellectual and/or industrial property and/or with respect to claims of infringement.

8.3 Except as to claims Unipac agrees in writing to defend, BUYER WILL INDEMNIFY, DEFEND AND HOLD HARMLESS UNIPAC FROM ALL CLAIMS, COSTS, LOSSES, AND DAMAGES (INCLUDING ATTORNEYS' FEES) AGAINST AND/OR ARISING OUT OF GOODS SOLD AND/OR SHIPPED HEREUNDER.

9 NO CONFIDENTIAL INFORMATION

Unipac shall have no obligation to hold any information in confidence except as provided in a separate non-disclosure agreement signed by both parties.

10 ENTIRE AGREEMENT

These terms and conditions are the entire agreement between Unipac and Buyer, and no addition, deletion or modification shall be binding on Unipac unless expressly agreed to in a writing signed by an officer of Unipac. Buyer is not relying upon any warranty or representation except for those specifically stated here.

11 APPLICABLE LAW

This Agreement and all performance and disputes arising out of or relating to goods involved will be governed by the laws of Taiwan, Republic of China, without reference to conflict of laws principles and excluding the U.N. Convention on Contracts for the International Sale of Goods. Buyer agrees at its sole expense to comply with all applicable laws in connection with the purchase, use or sale of the goods provided hereunder.

12 DISPUTE RESOLUTION

12.1 Buyer and Unipac shall cooperate and attempt in good faith to resolve any and all disputes arising out of and/or relating to this Agreement and/or goods furnished pursuant to this Agreement.

12.2 Any disputes relating to and/or arising out of any Agreement and/or goods furnished pursuant to this Agreement that cannot be so resolved will be decided exclusively by binding arbitration. Such arbitration shall take place in Taipei, Taiwan pursuant to the Rules for International Arbitrations under the American Arbitration Association.

12.3 Notwithstanding anything to the contrary, any party may apply to any court of competent jurisdiction for interim injunctive relief with respect to irreparable harm which cannot be avoided and/or compensated by such arbitration proceedings, without breach of this Article 12 and without any abridgment of the powers of the arbitrators.

13 ATTORNEYS' FEES

Reasonable attorneys' fees and costs will be awarded to the prevailing party in the event of litigation involving the enforcement or interpretation of this Agreement.

Unipac optoelectronics corp.

**No. 5 , Li-Hsin Road 6,
Science-Based Industrial Park,
Hsin-Chu City, Taiwan, R.O.C.**

Fax : 886-3-5632899

Tel : 886-3-5645768