

Specification

UP040D01

4.0" NTSC Color TFT

(160 x RGB) x 234

UNIPAC OPTOELECTRONICS CORPORATION

Spec. No. 233-220-075

Version : 0

Total pages: 19

Date : 1999/07/22

UP040D01 COLOR TFT-LCD PRELIMINARY SPECIFICATION

MODEL NAME: UP040D01

The content of this technical information
is subject to change without notice.
Please contact Unipac or its agent for
further information.

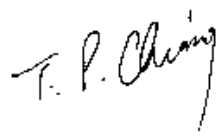
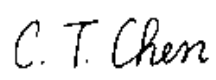
Approved by	Checked by	Prepared by
		

Contents:

A. Physical specifications	P3
B. Electrical specifications	P4
1. Pin assignment	P4
a. TFT-LCD panel driving section	P4
b. Backlight driving section	P5
2. Absolute maximum ratings	P5
3. Electrical characteristics	P6
a. Typical operating conditions	P6
b. Current consumption	P6
c. Backlight driving conditions	P6
4. AC Timing	P7
a. Timing conditions	P7
b. Timing diagram	P7
C. Optical specifications	P8
D. Reliability test items	P10
E. Packing form	P11

Appendix:

Fig.1 Outline dimension of TFT-LCD module	P12
Fig.2 Sampling clock timing	P13
Fig.3 Horizontal display timing range	P14
Fig.4-(a) Horizontal timing	P15
Fig.4-(b) Detail horizontal timing	P16
Fig.5 Vertical shift clock timing	P17
Fig.6-(a) Vertical timing (From up to down)	P18
Fig.6-(b) Vertical timing (From down to up)	P19

A.Physical specifications

NO.	Item	Specification	Remark
1	Display resolution(dot)	480(W) × 234(H)	
2	Active area(mm)	82.1(W) × 61.8(H)	
3	Screen size(inch)	4.05(Diagonal)	
4	Dot pitch(mm)	0.171(W) × 0.264(H)	
5	Color configuration	R.G.B delta	
6	Overall dimension(mm)	96.0(W) × 76.0(H) × 6.5(D)	Note 1
7	Weight(g)	(65±20)	

Note 1 : Refer to Fig. 1

B.Electrical specifications

1.Pin assignment

a. TFT-LCD panel driving section

Pin no.	Symbol	i/o	Description	Remark
1	GND	-	Ground for logic circuit	
2	V _{CC}	i	Supply voltage for logic control circuit for scan driver	
3	V _{GL}	i	Negative power for scan driver	
4	V _{GH}	i	Positive power for scan driver	
5	STVR	i/o	Vertical start pulse	Note 1
6	STVL	i/o	Vertical start pulse	Note 1
7	CKV	i	Shift clock input for scan driver	
8	U/D	i	UP/DOWN scan control input	Note 1,2
9	OEV	i	Output enable input for scan driver	
10	VCOM	i	Common electrode driving signal	
11	VCOM	i	Common electrode driving signal	
12	L/R	i	LEFT/RIGHT scan control input	Note 1,2
13	Q1H	i	Analog signal rotate input	
14	OEH	i	Output enable input for data driver	
15	STHL	i/o	Start pulse for horizontal scan line	Note 1
16	STHR	i/o	Start pulse for horizontal scan line	Note 1
17	CPH3	i	Sampling and shifting clock pulse for data driver	
18	CPH2	i	Sampling and shifting clock pulse for data driver	
19	CPH1	i	Sampling and shifting clock pulse for data driver	
20	V _{CC}	i	Supply voltage of logic control circuit for data driver	
21	GND	-	Ground for logic circuit	
22	VR	i	Alternated video signal input(Red)	
23	VG	i	Alternated video signal input(Green)	
24	VB	i	Alternated video signal input(Blue)	
25	AV _{DD}	i	Supply voltage for analog circuit	
26	AV _{SS}	-	Ground for analog circuit	

Note 1 : Selection of scanning mode

Setting of scan control input		IN/OUT state for start pulse				Scanning direction
U/D	L/R	STVR	STVL	STHR	STHL	
GND	V _{CC}	OUT	IN	OUT	IN	From up to down, and from left to right.
V _{CC}	GND	IN	OUT	IN	OUT	From down to up, and from right to left.
GND	GND	OUT	IN	IN	OUT	From up to down, and from right to left.
V _{CC}	V _{CC}	IN	OUT	OUT	IN	From down to up, and from left to right.

IN: Input; OUT: Output.

Note 2 : Definition of scanning direction.

Refer to figure as below:

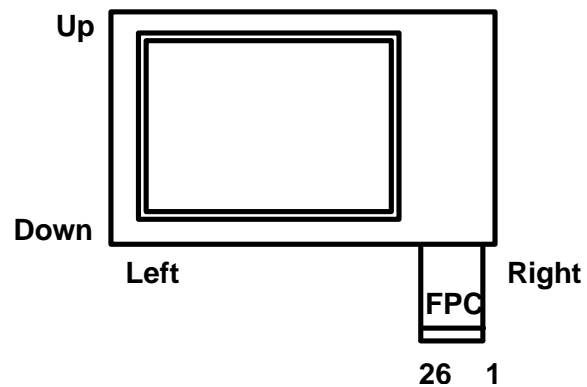

b. Backlight driving section(Refer to Fig.1)

No.	Symbol	I/O	Description	Remark
1	HI	i	Power supply for backlight unit (High voltage)	
2	GND	-	Ground	

2. Absolute maximum ratings

Item	Symbol	Condition	Min.	Max.	Unit	Remark
Power voltage	V _{CC}	GND=0	-0.3	7	V	
	AV _{DD}	AV _{SS} =0	-0.3	7	V	
	V _{GH}	GND=0	-0.3	18	V	
	V _{GL}		-15	0.3	V	
	V _{GH} - V _{GL}		-	31	V	
Input signal voltage	V _i		-0.3	AV _{DD} +0.3	V	Note 1
	V _l		-0.3	V _{CC} +0.3	V	Note 2
	V _{COM}		-2.9	5.2	V	
Operating temperature	T _{opa}		0	60	°C	Ambient temperature
Storage temperature	T _{stg}		-25	80	°C	Ambient temperature

Note 1: VR, VG, VB

Note 2: STHL, STHR, Q1H, OEH, L/R, CPH1 ~ CPH3, STVR, STVL, OEV, CKV, U/D

3. Electrical characteristics

a. Typical operating conditions (GND=AV_{SS}=0V , Note 5)

Item		Symbol	Min.	Typ.	Max.	Unit	Remark
Power supply		V _{CC}	4.8	5	5.2	V	
		AV _{DD}	4.8	5	5.2	V	
		V _{GH}	14.3	15	15.7	V	
		V _{GLAC}	3.5	5	7.5	Vp-p	AC component of V _{GL} , Note 1
		V _{GLDC}	-10.5	-10	-9.5	V	DC component of V _{GL}
Video signal amplitude (VR, VG, VB)		V _{iA}	AV _{SS} +0.4	-	AV _{DD} -0.8	V	Note 2
		V _{iAC}	-	3	-	V	AC component
		V _{iDC}	-	AV _{DD} /2	-	V	DC component
VCOM		V _{CAC}	3.5	5	7.5	Vp-p	AC component, Note 3
		V _{CDC}	-	1.3	-	V	DC component
Input signal voltage	H Level	V _{IH}	4	-	V _{CC}	V	Note 4
	L Level	V _{IL}	0	-	1	V	

Note 1: The same phase and amplitude with common electrode driving signal(VCOM).

Note 2: Refer to Fig.4-(a)

Note 3: The brightness of LCD panel could be changed by adjusting the AC component of VCOM.

Note 4: STHL, STHR, Q1H, OEH, L/R, CPH1 ~ CPH3, STVR, STVL, OEV, U/D, CKV .

Note 5: Be sure to apply GND , V_{CC} , V_{GL} to the LCD first , and then apply V_{GH} .

b. Current consumption (GND=AV_{SS}=0V)

Parameter	Symbol	Condition	Min.	Typ.	Max.	Unit	Remark
Current for driver	I _{GH}	V _{GH} =15V	-	80	150	μA	
	I _{GL}	V _{GL} = -10V	-	-0.2	-0.4	mA	
	I _{CC}	V _{CC} =5V	-	2.0	4.0	mA	
	I _{DD}	AV _{DD} =5V	-	5	10	mA	

c. Backlight driving conditions

Parameter	Symbol	Min.	Typ.	Max.	Unit	Remark
Lamp voltage	V _L	260	290	320	Vrms	
Lamp current	I _L	2.5	2.9	3.3	mArms	
Frequency	F _L	55	60	65	KHz	
Lamp Starting voltage	V _s	-	-	580	Vrms	Note 1
		-	-	870	Vrms	Note 2

Note 1: Ta = 25 °C

Note 2: Ta = 0 °C

4.AC Timing

a.Timing conditions

Parameter	Symbol	Min.	Typ.	Max.	Unit.	Remark
Rising time	t_r	-	-	10	ns	Note 1
Falling time	t_f	-	-	10	ns	Note 1
High and low level pulse width	t_{CPH}	299	308	319	ns	CPH1~CPH3
CPH pulse duty	t_{CWH}	40	50	60	%	CPH1~CPH3
CPH pulse delay	t_{C12} t_{C23} t_{C31}	70	$t_{CPH}/3$	$t_{CPH}/2$	ns	CPH1; CPH3
STH setup time	t_{SUH}	35	-	-	ns	STHR,STHL
STH hold time	t_{HDH}	35	-	-	ns	STHR,STHL
STH pulse width	t_{STH}	-	1	-	t_{CPH}	STHR,STHL
STH period	t_H	61.5	63.5	65.5	μS	STHR,STHL
OEH pulse width	t_{OEH}	-	3	-	t_{CPH}	OEH
Sample and hold disable time	t_{DIS1}	-	28	-	t_{CPH}	
OEV pulse width	t_{OEV}	-	12	-	t_{CPH}	OEV
CKV pulse width	t_{CKV}	16	28	40	t_{CPH}	CKV
Clean enable time	t_{DIS2}	-	10	-	t_{CPH}	
Horizontal display start	t_{SH}	-	0	-	$t_{CPH}/3$	
Horizontal display timing range	t_{DH}	-	480	-	$t_{CPH}/3$	
STV setup time	t_{SUV}	400	-	-	ns	STVL,STVR
STV hold time	t_{HDV}	400	-	-	ns	STVL,STVR
STV pulse width	t_{STV}	-	-	1	t_H	STVL,STVR
Horizontal lines per field	t_V	256	262	268	t_H	Note 2
Vertical display start	t_{SV}	-	3	-	t_H	
Vertical display timing range	t_{DV}	-	234	-	t_H	
VCOM rising time	t_{rCOM}	-	-	3	μS	
VCOM falling time	t_{fCOM}	-	-	3	μS	
VCOM delay time	t_{DCOM}	-	-	3	μS	
RGB delay time	t_{DRGB}	-	-	1	μS	

Note 1: For all of the logic signals.

Note 2: Please don't use odd horizontal lines to drive LCD panel for both odd and even field simultaneously.

b.Timing diagram

Please refer to the attached drawing, from Fig.2 to Fig.6.

C.Optical specifications (Note 1,Note 2, Note 3)

Item	Symbol	Condition	Min.	Typ.	Max.	Unit	Remark
Response time	Rise	$\theta = 0^\circ$	-	25	50	ms	Note 4,6
	Fall		-	30	60	ms	
Contrast ratio	CR	At optimized viewing angle	60	150			Note 5,6
Viewing angle	Top	$CR \geq 10$	10	-	-	deg.	Note 6,7
	Bottom		30	-	-		
	Left		45	-	-		
	Right		45	-	-		
Brightness	Y_L	$\theta = 0^\circ$	210	250	-	nit	Note 8
White chromaticity	x	$\theta = 0^\circ$	0.25	0.30	0.35		Note 8
	y		0.30	0.35	0.40		

Note 1. Ambient temperature = 25 °C, and lamp current $I_L=2.9mA$ rms.

Note 2. To be measured in the dark room.

Note 3. To be measured on the center area of panel with a viewing cone of 1° by Topcon luminance meter BM-7, after 10 minutes operation.

Note 4. Definition of response time:

The output signals of photodetector are measured when the input signals are changed from "black" to "white"(falling time) and from "white" to "black"(rising time),respectively.

The response time is defined as the time interval between the 10% and 90% of amplitudes. Refer to figure as below.

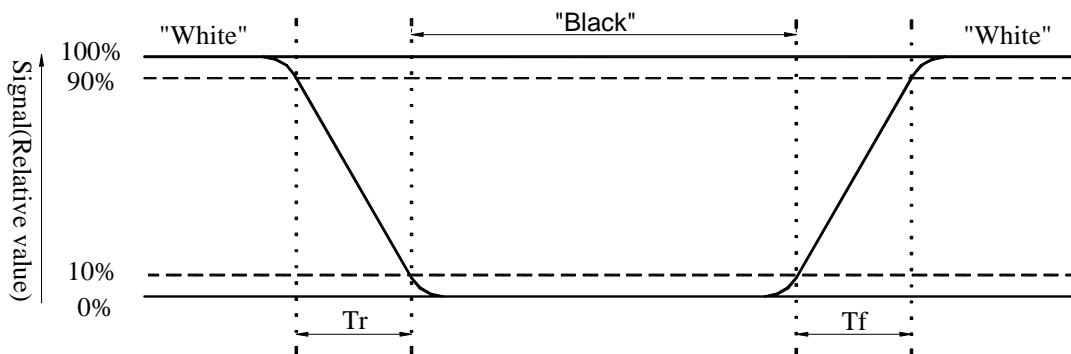

Note 5. Definition of contrast ratio:

Contrast ratio is calculated with the following formula.

$$\text{Contrast ratio (CR)} = \frac{\text{Photodetector output when LCD is at "White" state}}{\text{Photodetector output when LCD is at "Black" state}}$$

Note 6. White $V_i = V_{i50} \mp 1.5V$
Black $V_i = V_{i50} \pm 2.0V$

' \pm ' means that analog input signal swings in phase with COM signal.

' \mp ' means that analog input signal swings out of phase with COM signal.

V_{i50} : The analog input voltage when transmission is 50%.

The 100% transmission is defined as the transmission of LCD panel when all the input terminals of module are electrically opened.

Note 7. Definition of viewing angle:
Refer to figure as below.

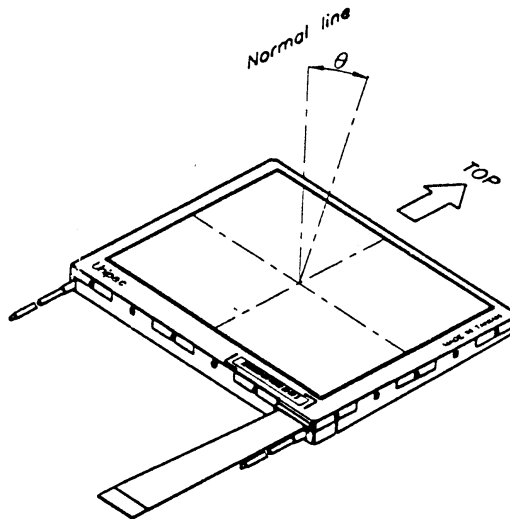

Note 8. Measured at the center area of the panel when all the input terminals of LCD panel are electrically opened.

D.Reliability test items:

No.	Test items	Conditions	Remark
1	High temperature storage	Ta = 80°C 240H	
2	Low temperature storage	Ta = -25°C 240H	
3	High temperature operation	Ta = 60°C 240H	
4	Low temperature operation	Ta = 0°C 240H	
5	High temperature and high humidity	Ta = 60°C · 95%RH 240H	Operation
6	Heat shock	-25°C ~ +80°C/50 cycles 2H/cycle	Non-operation
7	Electrostatic discharge	± 200V, 200pF(0Ω),once for each terminal	Non-operation
8	Vibration	Frequency range:10 ~ 55Hz Stroke :1.5mm Sweep :10j 55Hz ~ 10Hz 2 hours for each direction of X,Y,Z (6 hours for total)	JIS C7021,A-10 condition A
9	Mechanical shock	100G · 6ms, ±X, ±Y, ± Z 3 times for each direction	JIS C7021,A-7 condition C
10	Vibration (with carton)	Random vibration: 0.015G ² /Hz from 5 ~ 200Hz -6dB/Octave from 200 ~ 500Hz	IEC 68-34
11	Drop (with carton)	Height: 80cm 1 corner,3 edges,6 surfaces	

Note: Ta: Ambient temperature.

E. Packing form

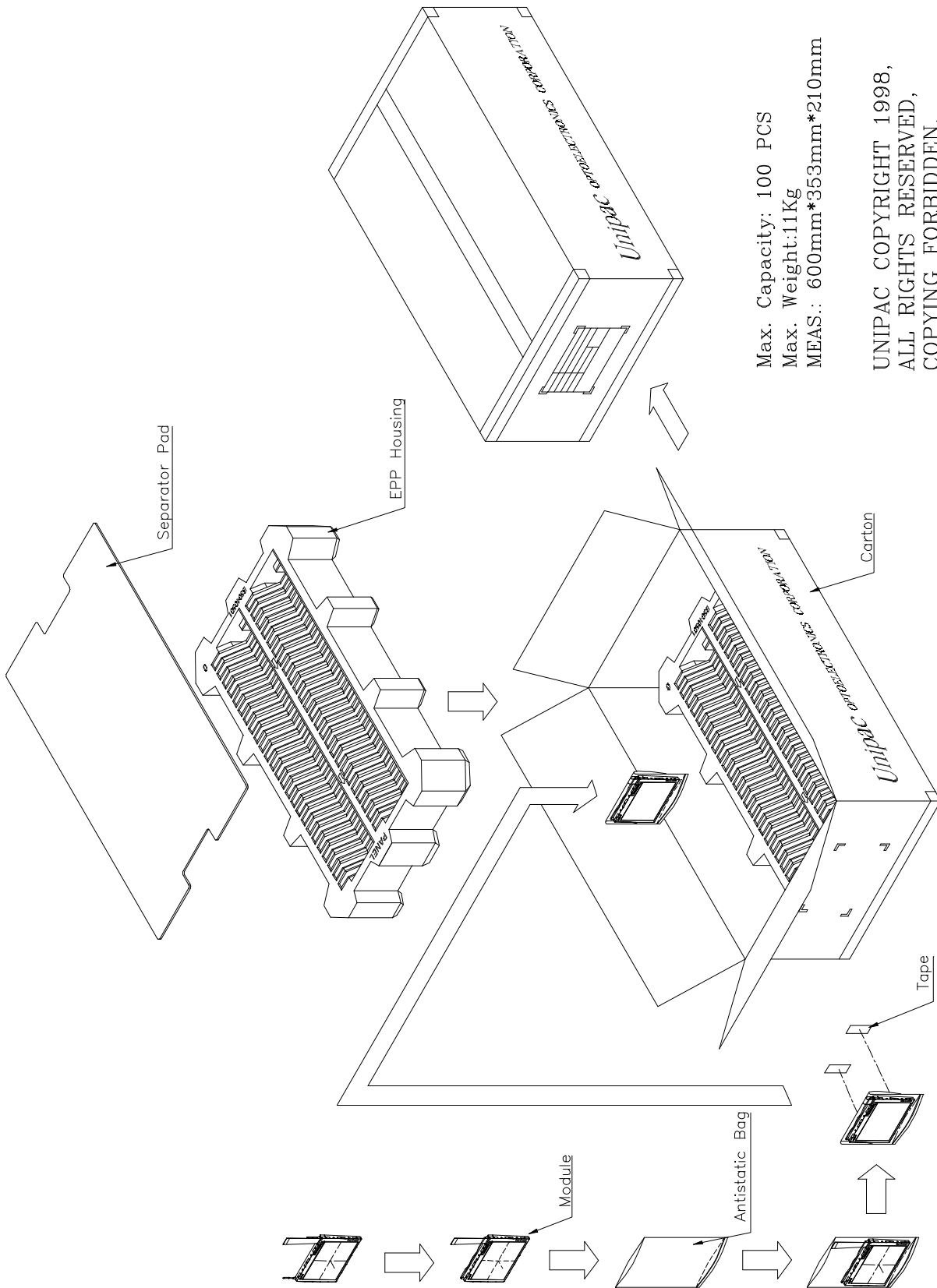

Max. Capacity: 100 PCS
Max. Weight: 11Kg
MEAS.: 600mm*353mm*210mm

UNIPAC COPYRIGHT 1998,
ALL RIGHTS RESERVED,
COPYING FORBIDDEN.

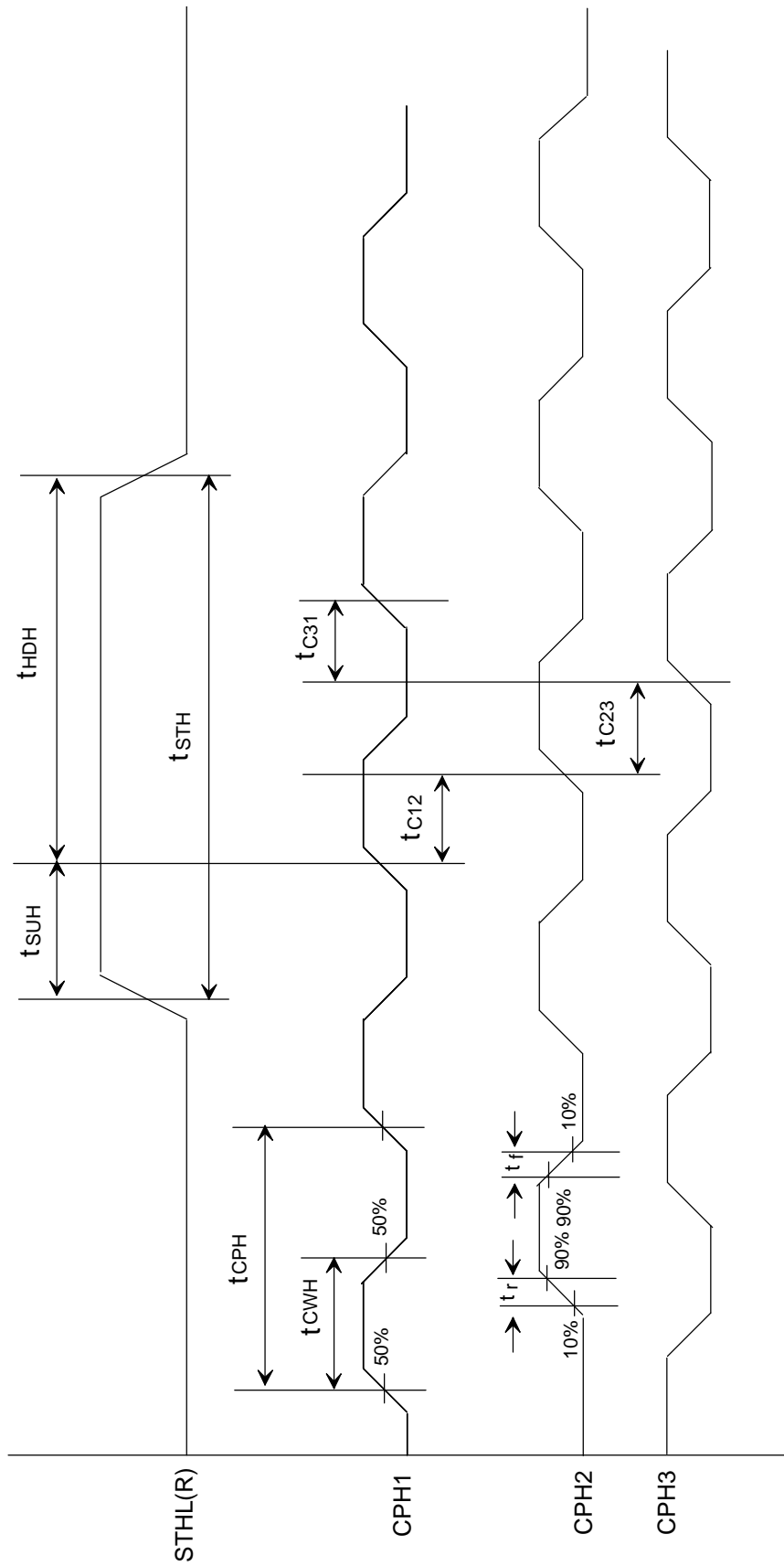

Fig.2 Sampling clock timing

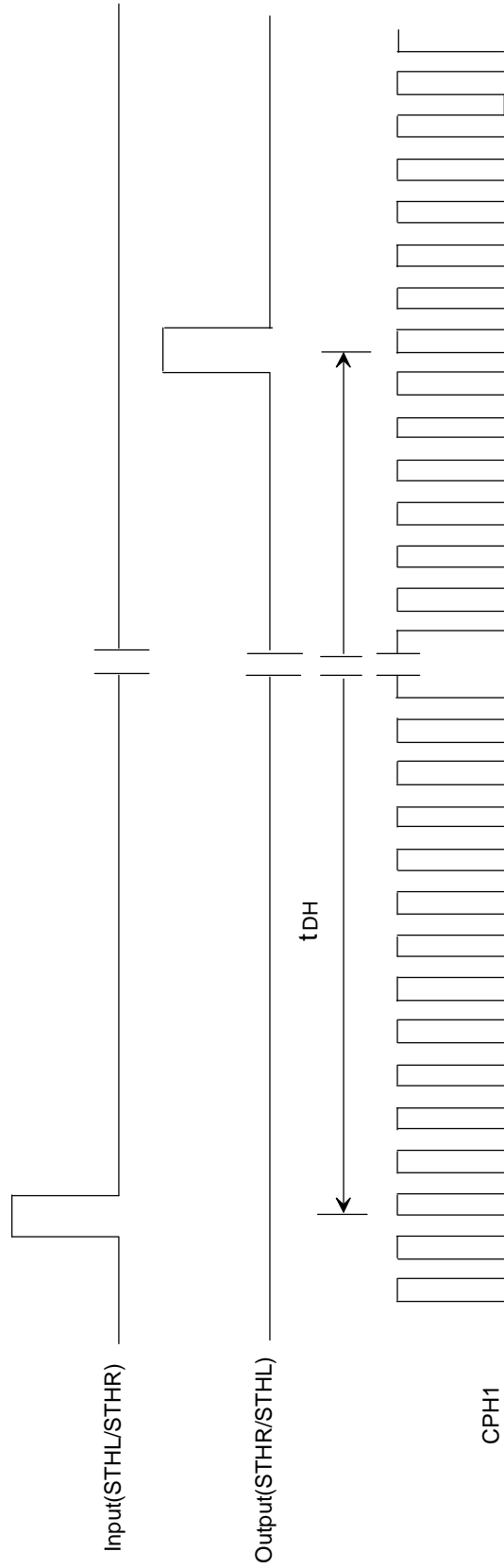

Fig.3 Horizontal display timing range

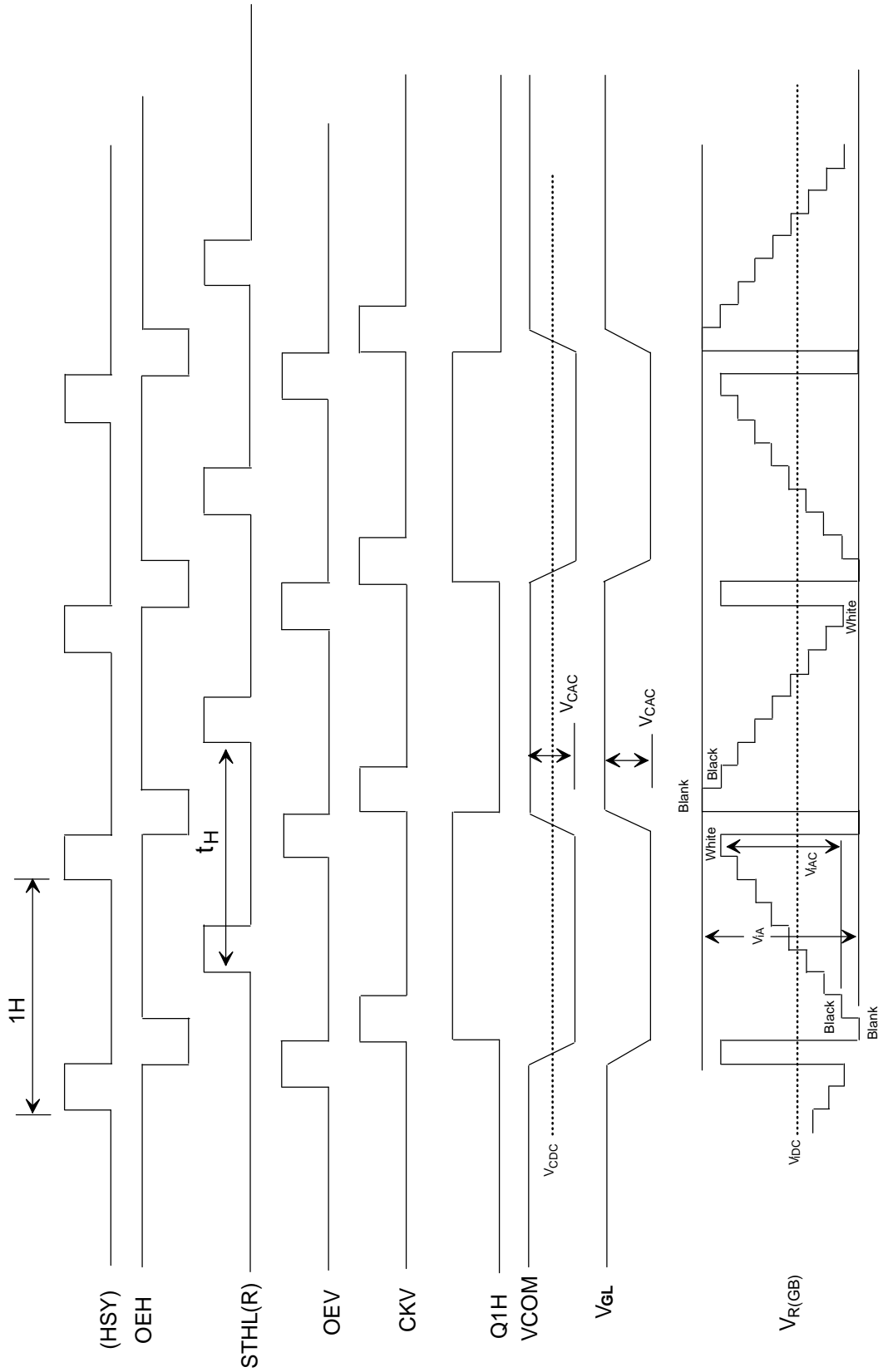
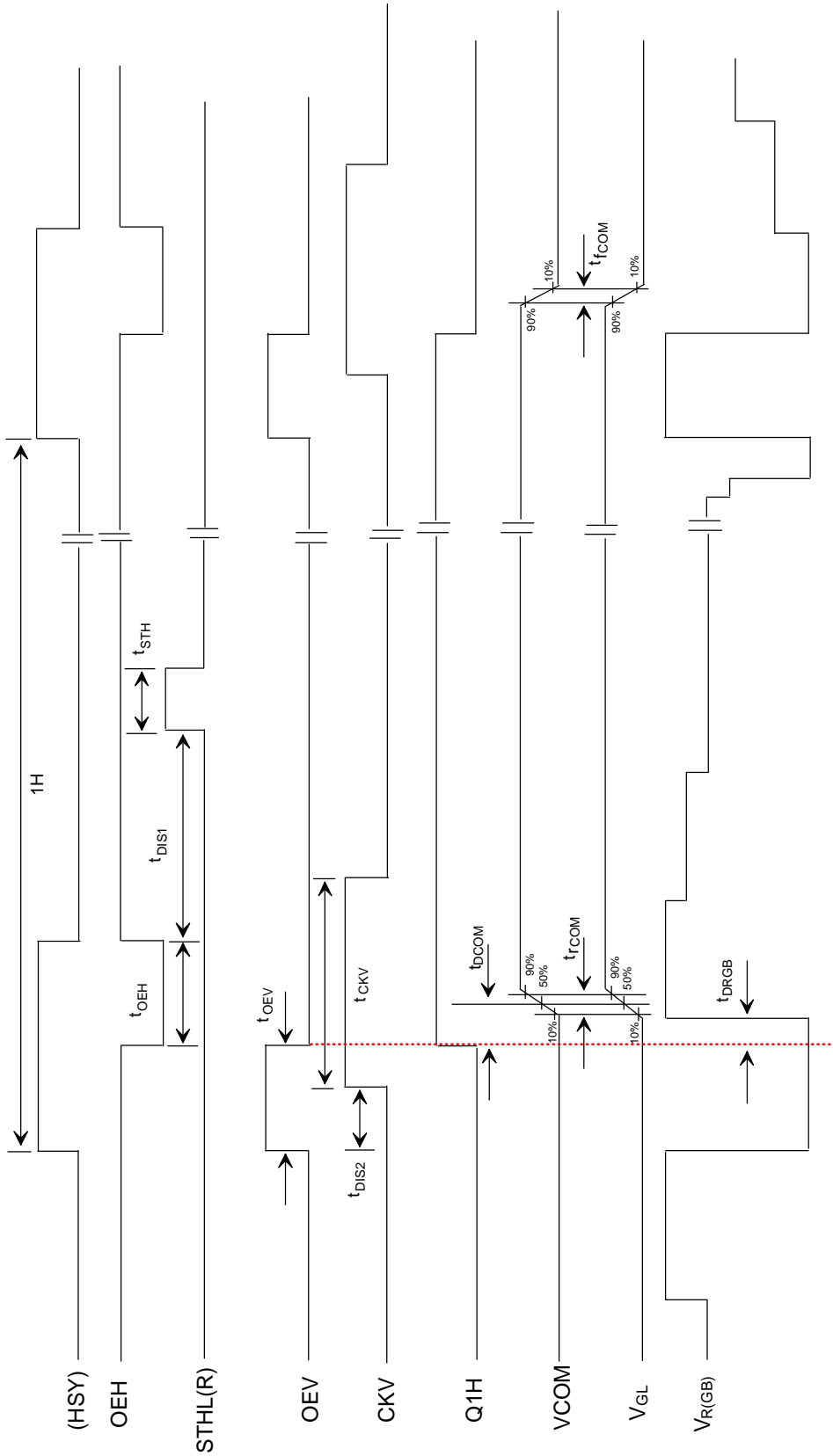

Fig.4-(a) Horizontal timing



Note: The rising edge of Q1H and the falling edge of OEH should be synchronized with the falling edge of OEH

Fig.4-(b) Detail horizontal timing

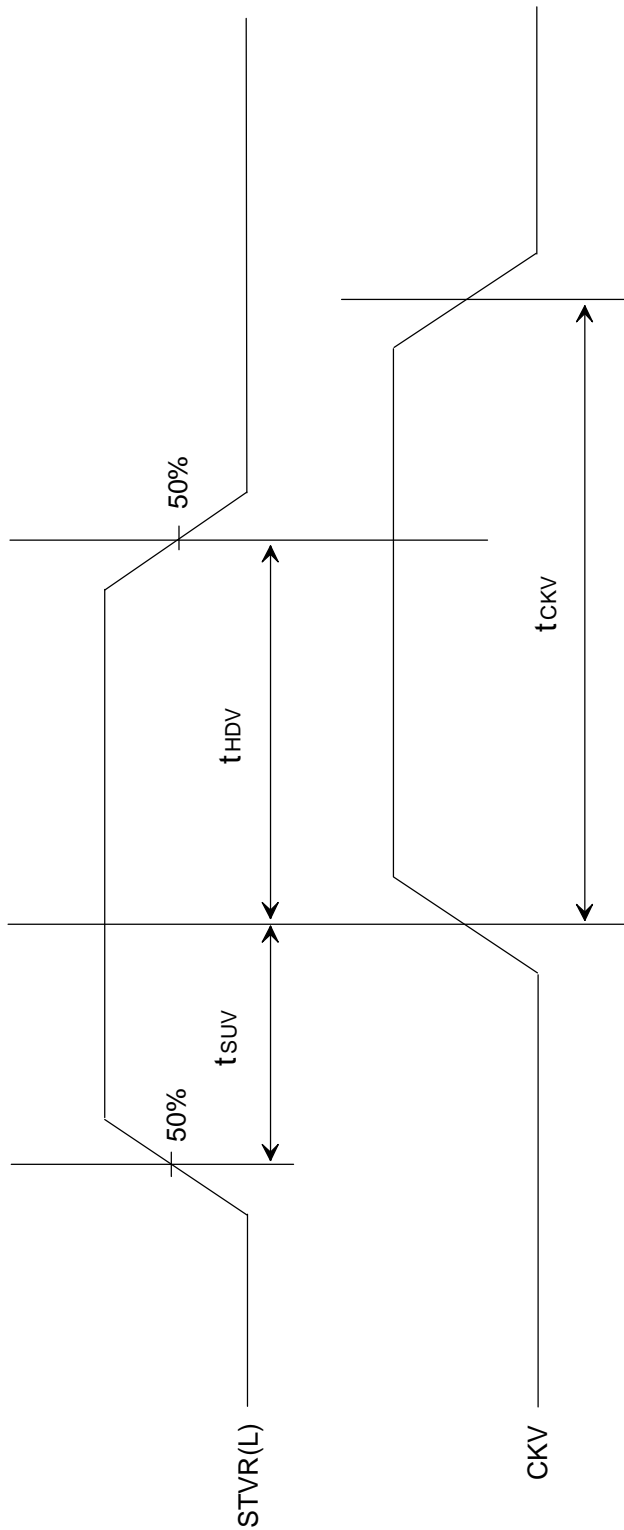

Fig.5 Vertical shift clock timing

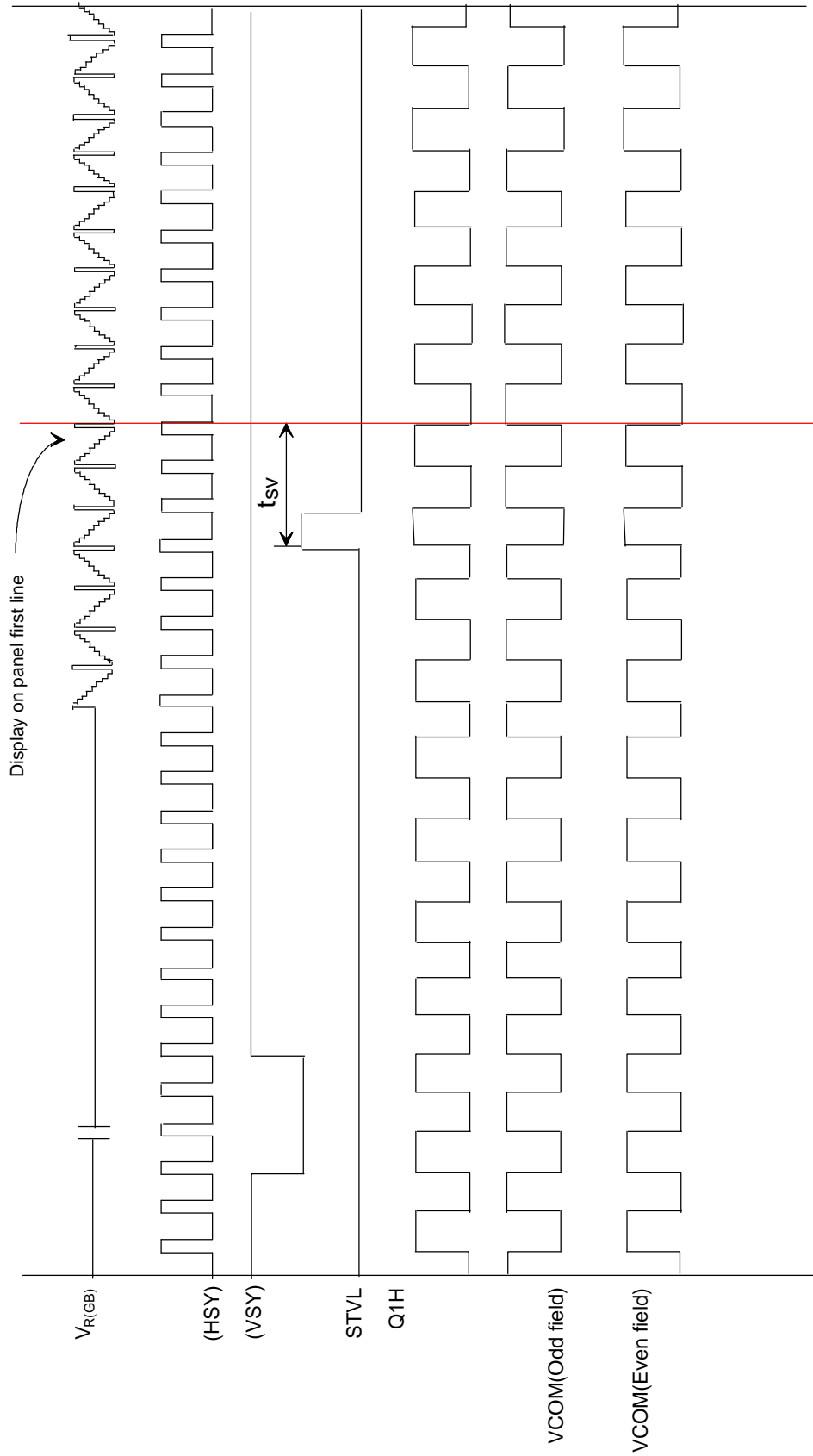

Fig.6-(a) Vertical timing (From up to down)

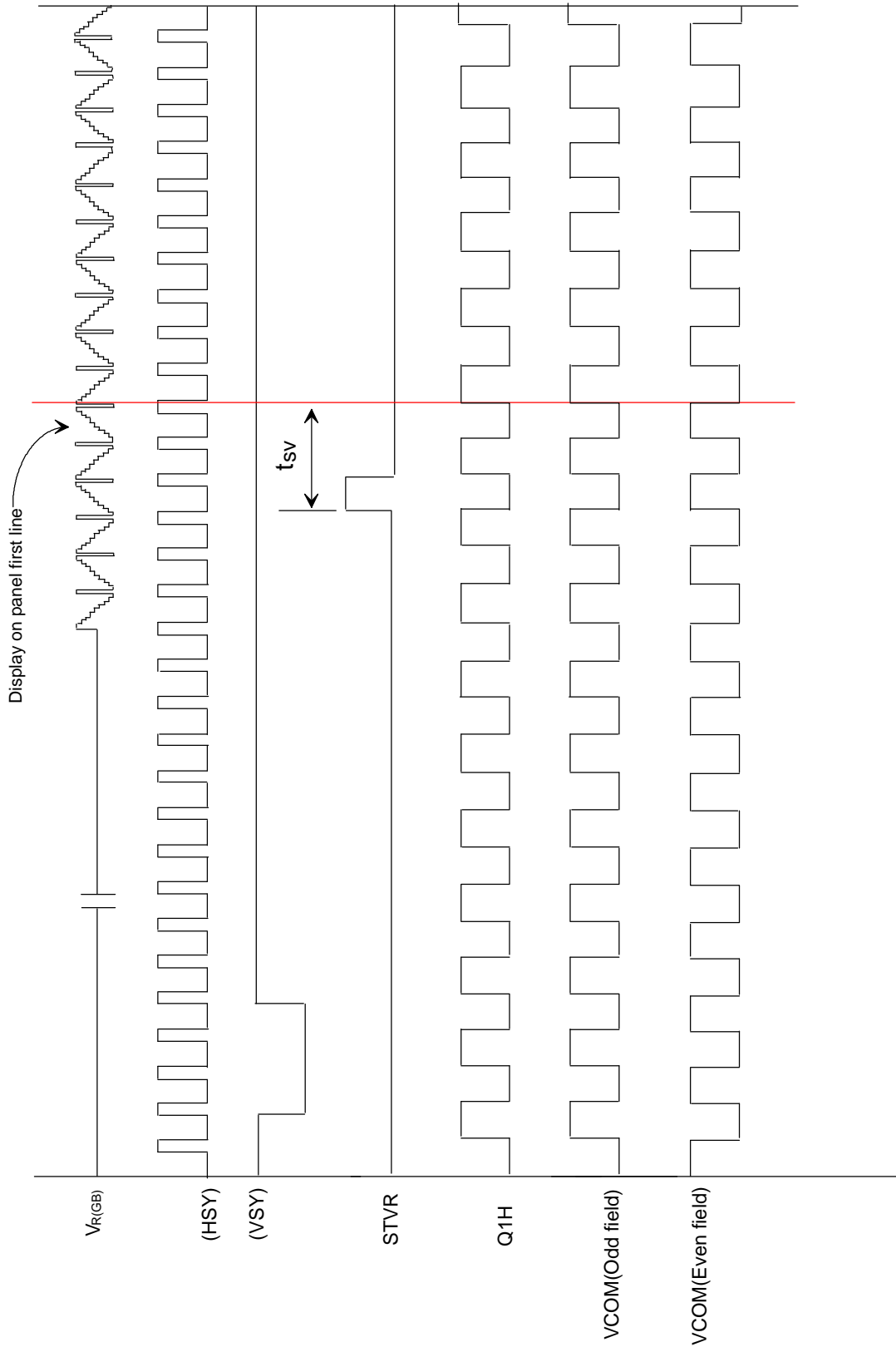

Fig.6-(b) Vertical timing (From down to up)