

N-CHANNEL ENHANCEMENT MODE FIELD EFFECT TRANSISTOR

NEW PRODUCT

Features

- Low Gate Threshold Voltage
- Low Input Capacitance
- Fast Switching Speed
- Low Input/Output Leakage
- High Drain-Source Voltage Rating

Mechanical Data

- Case: SOT-323, Molded Plastic
- Plastic Material - UL Flammability Classification Rating 94V-0
- Moisture sensitivity: Level 1 per J-STD-020A
- Terminals: Solderable per MIL-STD-202, Method 208
- Terminal Connections: See Diagram
- Marking: K23 (See Page 3)
- Weight: 0.006 grams (approx.)

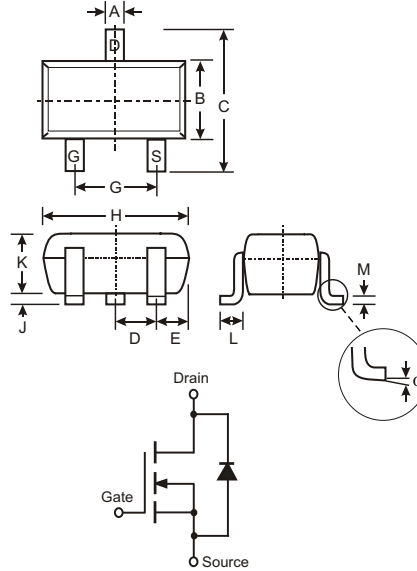

SOT-323		
Dim	Min	Max
A	0.25	0.40
B	1.15	1.35
C	2.00	2.20
D	0.65 Nominal	
E	0.30	0.40
G	1.20	1.40
H	1.80	2.20
J	0.0	0.10
K	0.90	1.00
L	0.25	0.40
M	0.10	0.18
α	0°	8°
All Dimensions in mm		

Maximum Ratings @ T_A = 25°C unless otherwise specified

Characteristic	Symbol	Value	Units
Drain-Source Voltage	V _{DSS}	100	V
Drain-Gate Voltage R _{GS} ≤ 20KΩ	V _{DGR}	100	V
Gate-Source Voltage	V _{GSS}	±20	V
Drain Current (Note 1)	I _D I _{DM}	170 680	mA
Total Power Dissipation (Note 1)	P _d	200	mW
Thermal Resistance, Junction to Ambient (Note 1)	R _{θJA}	625	°C/W
Operating and Storage Temperature Range	T _j , T _{STG}	-55 to +150	°C

Notes: 1. Device mounted on FR-4 PC board with recommended pad layout, which can be found on our website at <http://www.diodes.com/datasheets/ap02001.pdf>.

Electrical Characteristics @ $T_A = 25^\circ\text{C}$ unless otherwise specified

Characteristic	Symbol	Min	Typ	Max	Unit	Test Condition
OFF CHARACTERISTICS (Note 2)						
Drain-Source Breakdown Voltage	BV_{DSS}	100	—	—	V	$V_{GS} = 0V, I_D = 250\mu A$
Zero Gate Voltage Drain Current	I_{DSS}	—	—	1.0 10	μA nA	$V_{DS} = 100V, V_{GS} = 0V$ $V_{DS} = 20V, V_{GS} = 0V$
Gate-Body Leakage, Forward	I_{GSSF}	—	—	50	nA	$V_{GS} = 20V, V_{DS} = 0V$
ON CHARACTERISTICS (Note 2)						
Gate Threshold Voltage	$V_{GS(th)}$	0.8	1.4	2.0	V	$V_{DS} = V_{GS}, I_D = 1mA$
Static Drain-Source On-Resistance	$R_{DS(on)}$	—	—	6.0 10	Ω	$V_{GS} = 10V, I_D = 0.17A$ $V_{GS} = 4.5V, I_D = 0.17A$
Forward Transconductance	g_{FS}	80	370	—	mS	$V_{DS} = 10V, I_D = 0.17A, f = 1.0KHz$
Drain-Source Diode Forward Voltage	V_{SD}	—	0.84	1.3	V	$V_{GS} = 0V, I_S = 0.34A$
DYNAMIC CHARACTERISTICS						
Input Capacitance	C_{iss}	—	29	60	pF	$V_{DS} = 25V, V_{GS} = 0V$ $f = 1.0MHz$
Output Capacitance	C_{oss}	—	10	15	pF	
Reverse Transfer Capacitance	C_{rss}	—	2	6	pF	
SWITCHING CHARACTERISTICS						
Turn-On Rise Time	t_r	—	—	8	ns	$V_{DD} = 30V, I_D = 0.28A,$ $R_{GEN} = 50\Omega, V_{GS} = 10V$
Turn-Off Fall Time	t_f	—	—	16	ns	
Turn-On Delay Time	$t_{D(ON)}$	—	—	8	ns	
Turn-Off Delay Time	$t_{D(OFF)}$	—	—	13	ns	

Notes: 2. Short duration test pulse used to minimize self-heating effect.

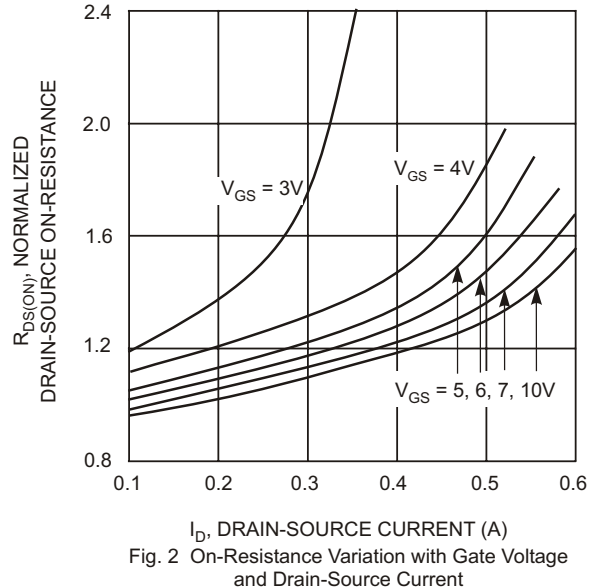
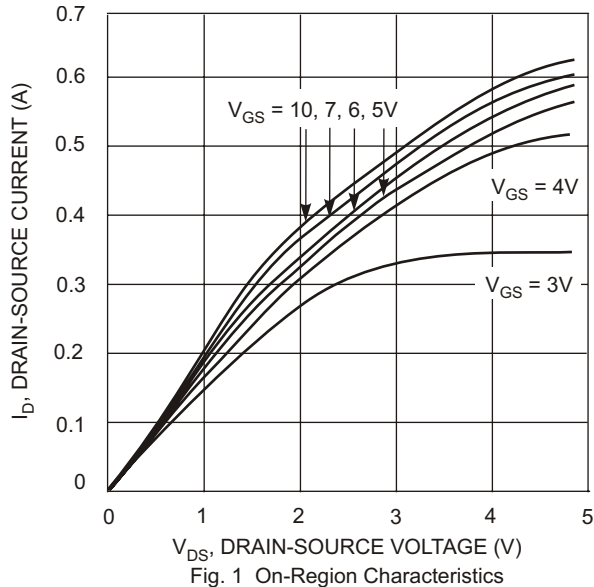

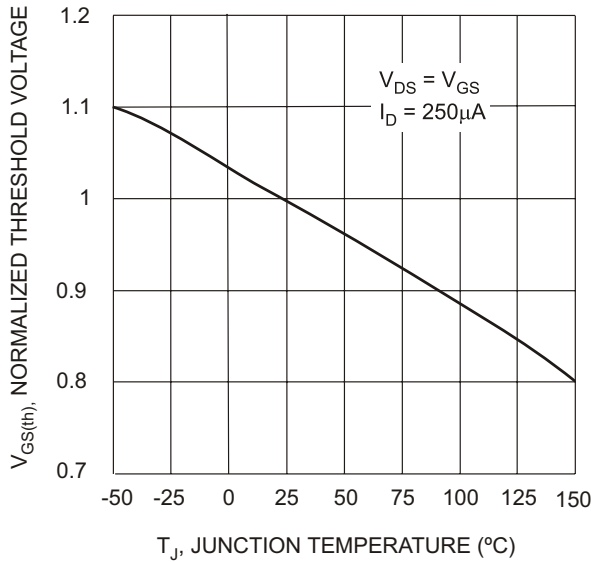

Fig. 3 Gate Threshold Variation with Temperature

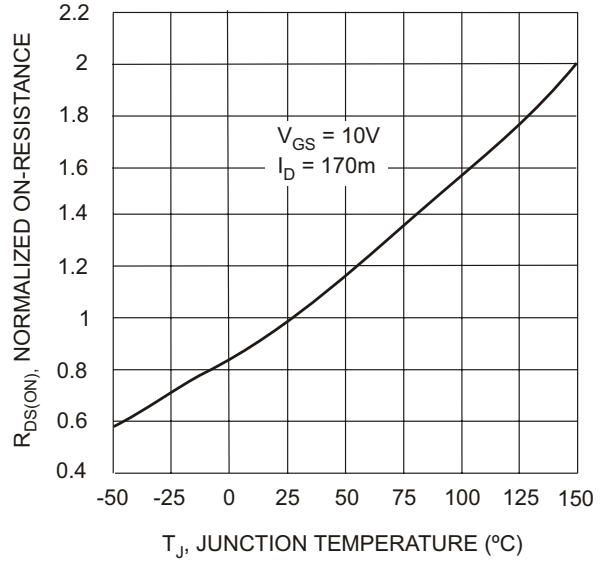

Fig. 4 On-Resistance Variation with Temperature

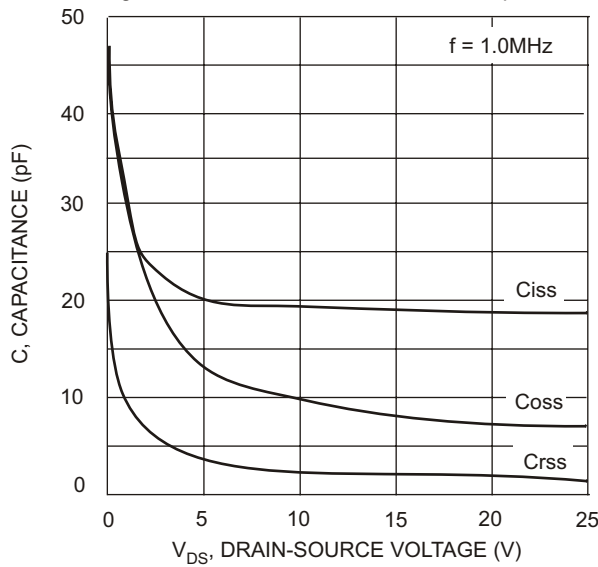

Fig. 5 Typical Capacitance

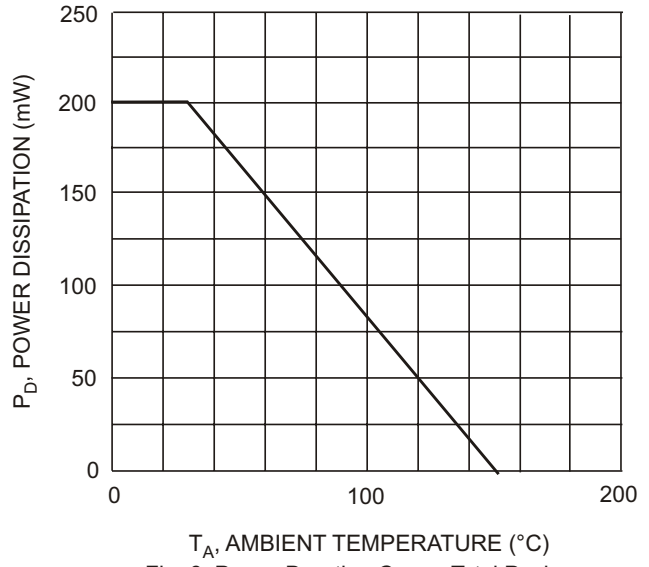

Fig. 6 Power Derating Curve, Total Package

Ordering Information (Note 3)

Device	Packaging	Shipping
BSS123W-7	SOT-323	3000/Tape & Reel

Notes: 3. For Packaging Details, go to our website at <http://www.diodes.com/datasheets/ap02007.pdf>.

Marking Information

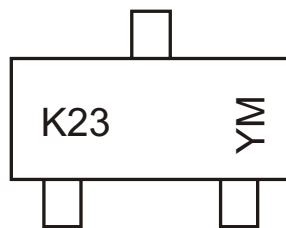

K23 = Product Type Marking Code
 YM = Date Code Marking
 Y = Year ex: N = 2002
 M = Month ex: 9 = September

Date Code Key

Year	2002	2003	2004	2005	2006	2007	2008	2009
Code	N	P	R	S	T	U	V	W

Month	Jan	Feb	March	Apr	May	Jun	Jul	Aug	Sep	Oct	Nov	Dec
Code	1	2	3	4	5	6	7	8	9	O	N	D