

# BTA208S-600B; BTA208S-800B

Three-quadrant triacs high commutation

Rev. 02 — 31 May 2005

Product data sheet

## 1. Product profile

### 1.1 General description

Passivated high commutation triac in a plastic envelope, suitable for surface mounting, intended for use in circuits where high static and dynamic  $dV/dt$  and high  $dI/dt$  can occur. These devices will commute the full rated RMS current at the maximum rated junction temperature, without the aid of a snubber.

### 1.2 Features

- High maximum junction temperature
- High commutation capability
- Surface mounting package
- Low thermal resistance

### 1.3 Quick reference data

- $V_{DRM} \leq 600$  V (BTA208S-600B)
- $V_{DRM} \leq 800$  V (BTA208S-800B)
- $I_{T(RMS)} \leq 8$  A
- $I_{TSM} \leq 65$  A

## 2. Pinning information

Table 1: Pinning

Pin	Description	Simplified outline	Symbol
1	main terminal 1 (T1)	<p>SOT428 (DPAK)</p>	
2	main terminal 2 (T2)		
3	gate (G)		
mb	mounting base		

[1] Connected to main terminal 2 (T2).

PHILIPS

### 3. Ordering information

Table 2: Ordering information

Type number	Package		Version
	Name	Description	
BTA208S-600B	TO-252	plastic single-ended surface mounted package (DPAK); 3 leads (one lead cropped)	SOT428
BTA208S-800B			

### 4. Limiting values

Table 3: Limiting values

In accordance with the Absolute Maximum Rating System (IEC 60134).

Symbol	Parameter	Conditions	Min	Max	Unit
$V_{DRM}$	repetitive peak off-state voltage				
	BTA208S-600B		[1] -	600	V
	BTA208S-800B		-	800	V
$I_{T(RMS)}$	RMS on-state current	full sine wave; $T_{mb} \leq 102\text{ °C}$ ; see <a href="#">Figure 4</a> and <a href="#">5</a>	-	8	A
$I_{TSM}$	non-repetitive peak on-state current	full sine wave; $T_j = 25\text{ °C}$ prior to surge; see <a href="#">Figure 2</a> and <a href="#">3</a>			
		$t = 20\text{ ms}$	-	65	A
		$t = 16.7\text{ ms}$	-	71	A
$I^2t$	$I^2t$ for fusing	$t = 10\text{ ms}$	-	21	A <sup>2</sup> s
$dl_T/dt$	rate of rise of on-state current	$I_{TM} = 12\text{ A}$ ; $I_G = 0.2\text{ A}$ ; $dI_G/dt = 0.2\text{ A}/\mu\text{s}$	-	100	A/ $\mu\text{s}$
$I_{GM}$	peak gate current		-	2	A
$V_{GM}$	peak gate voltage		-	5	V
$P_{GM}$	peak gate power		-	5	W
$P_{G(AV)}$	average gate power	over any 20 ms period	-	0.5	W
$T_{stg}$	storage temperature		-40	+150	°C
$T_j$	junction temperature		-	125	°C

[1] Although not recommended, off-state voltages up to 800 V may be applied without damage, but the triac may switch to the on-state. The rate of rise of current should not exceed 6 A/ $\mu\text{s}$ .

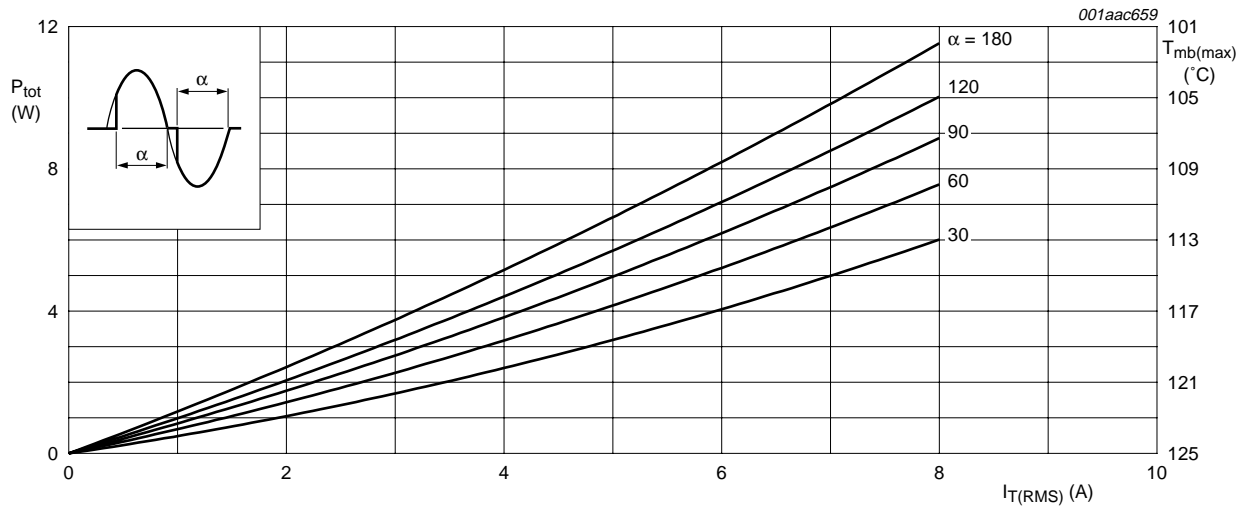

$\alpha$  = conduction angle

**Fig 1. On-state power dissipation as a function of RMS on-state current; maximum values**

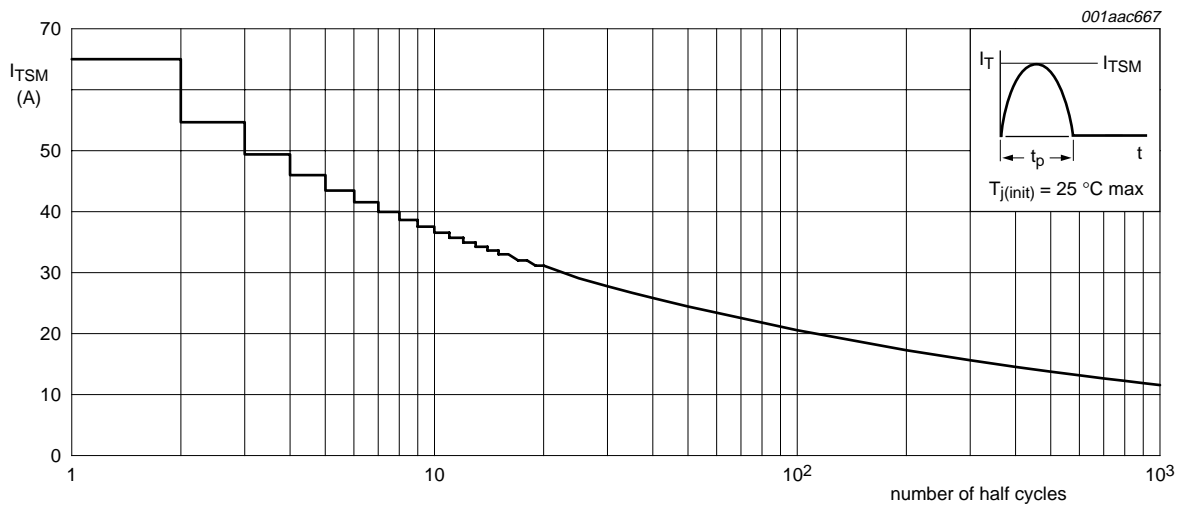

f = 50 Hz

**Fig 2. Non-repetitive peak on-state current as a function of number of half cycles; sinusoidal currents; maximum values**

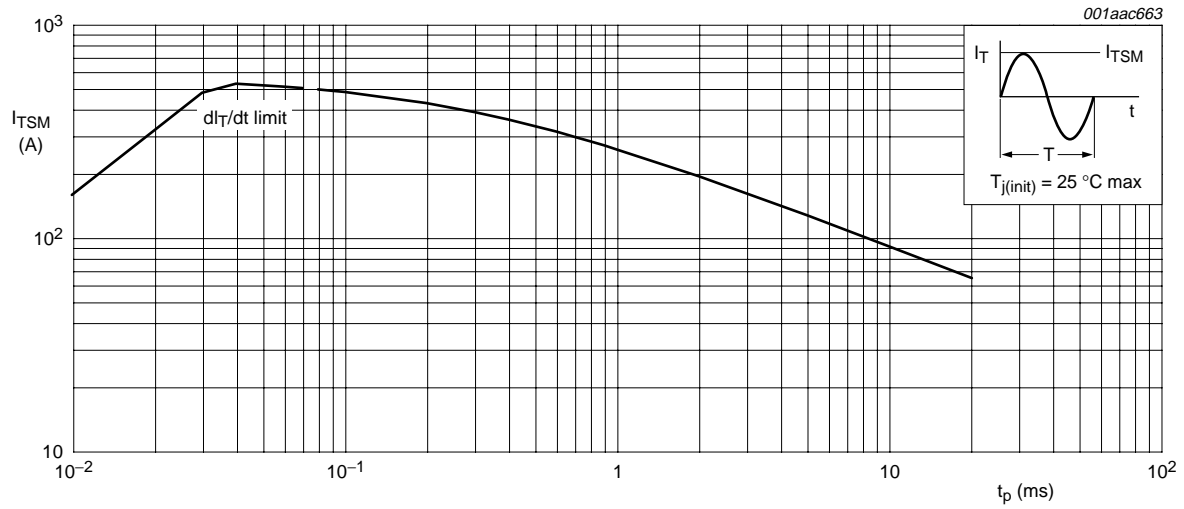

$t_p \leq 20$  ms

**Fig 3. Non-repetitive peak on-state current as a function of pulse width; sinusoidal currents; maximum values**

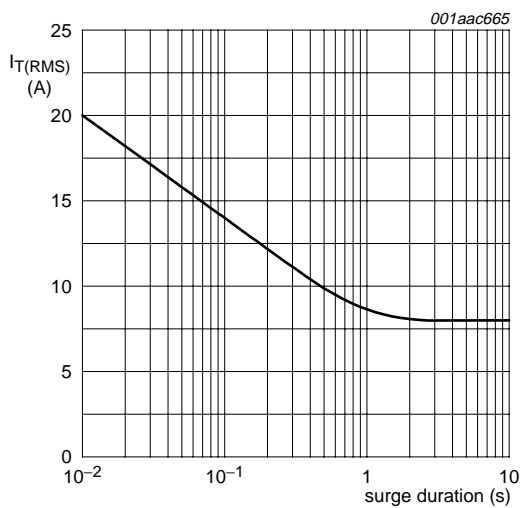

$f = 50$  Hz;  $T_{mb} \leq 102^\circ\text{C}$

**Fig 4. RMS on-state current as a function of surge duration; sinusoidal currents; maximum values**

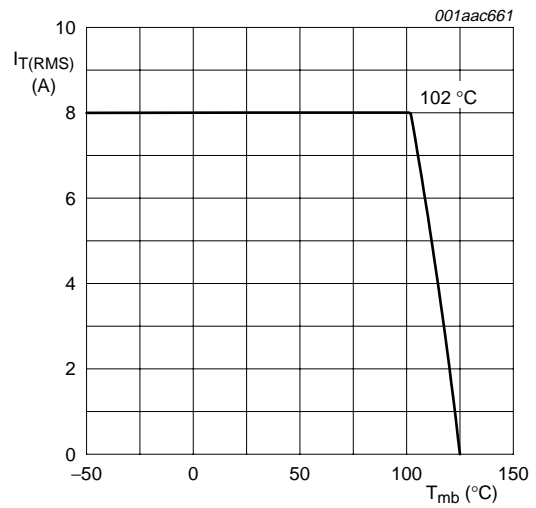
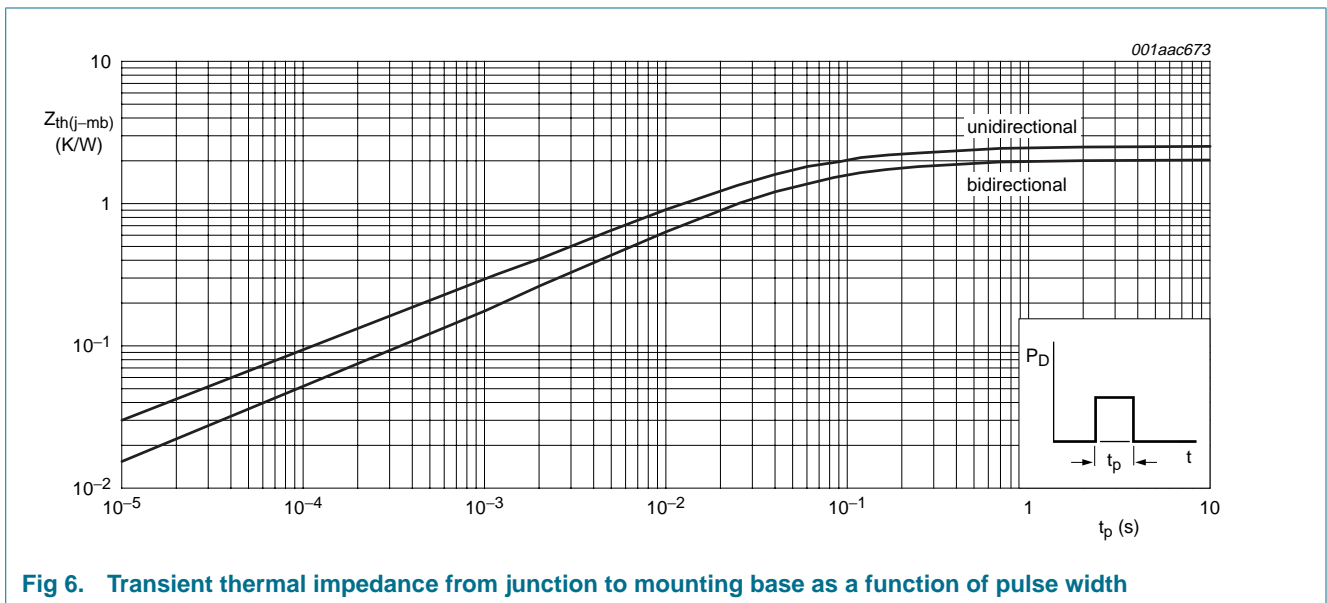

**Fig 5. RMS on-state current as a function of mounting base temperature; maximum values**

## 5. Thermal characteristics

**Table 4: Thermal characteristics**

Symbol	Parameter	Conditions	Min	Typ	Max	Unit
$R_{th(j-mb)}$	thermal resistance from junction to mounting base	full cycle; see <a href="#">Figure 6</a>	-	-	2.0	K/W
		half cycle; see <a href="#">Figure 6</a>	-	-	2.4	K/W
$R_{th(j-a)}$	thermal resistance from junction to ambient	printed-circuit board (FR4) mounted; footprint as in <a href="#">Figure 14</a>	-	75	-	K/W



## 6. Static characteristics

**Table 5: Static characteristics**

$T_j = 25\text{ °C}$  unless otherwise specified.

Symbol	Parameter	Conditions	Min	Typ	Max	Unit
$I_{GT}$	gate trigger current	$V_D = 12\text{ V}$ ; $I_T = 0.1\text{ A}$ ; see <a href="#">Figure 8</a>	[1]			
		T2+ G+	2	18	50	mA
		T2+ G-	2	21	50	mA
		T2- G-	2	34	50	mA
$I_L$	latching current	$V_D = 12\text{ V}$ ; $I_{GT} = 0.1\text{ A}$ ; see <a href="#">Figure 10</a>				
		T2+ G+	-	31	60	mA
		T2+ G-	-	34	90	mA
		T2- G-	-	30	60	mA
$I_H$	holding current	$V_D = 12\text{ V}$ ; $I_{GT} = 0.1\text{ A}$ ; see <a href="#">Figure 11</a>	-	31	60	mA
$V_T$	on-state voltage	$I_T = 10\text{ A}$ ; see <a href="#">Figure 9</a>	-	1.3	1.65	V
$V_{GT}$	gate trigger voltage	$V_D = 12\text{ V}$ ; $I_T = 0.1\text{ A}$ ; see <a href="#">Figure 7</a>	-	0.7	1.5	V
		$V_D = 400\text{ V}$ ; $I_T = 0.1\text{ A}$ ; $T_j = 125\text{ °C}$	0.25	0.4	-	V
$I_D$	off-state current	$V_D = V_{DRM(max)}$ ; $T_j = 125\text{ °C}$	-	0.1	0.5	mA

[1] Device does not trigger in the T2- G+ quadrant.

## 7. Dynamic characteristics

**Table 6: Dynamic characteristics**

$T_j = 25\text{ }^\circ\text{C}$  unless otherwise specified.

Symbol	Parameter	Conditions	Min	Typ	Max	Unit
$dV_D/dt$	rate of rise of off-state voltage	$V_{DM} = 0.67V_{DRM(max)}$ ; $T_j = 125\text{ }^\circ\text{C}$ ; exponential waveform; gate open circuit	1000	4000	-	V/ $\mu\text{s}$
$di_{com}/dt$	rate of rise of commutating current	$V_{DM} = 400\text{ V}$ ; $T_j = 125\text{ }^\circ\text{C}$ ; $I_{T(RMS)} = 8\text{ A}$ ; without snubber; gate open circuit; see <a href="#">Figure 12</a>	-	14	-	A/ms
$t_{gt}$	gate-controlled turn-on time	$I_{TM} = 12\text{ A}$ ; $V_D = V_{DRM(max)}$ ; $I_G = 0.1\text{ A}$ ; $di_G/dt = 5\text{ A}/\mu\text{s}$	-	2	-	$\mu\text{s}$

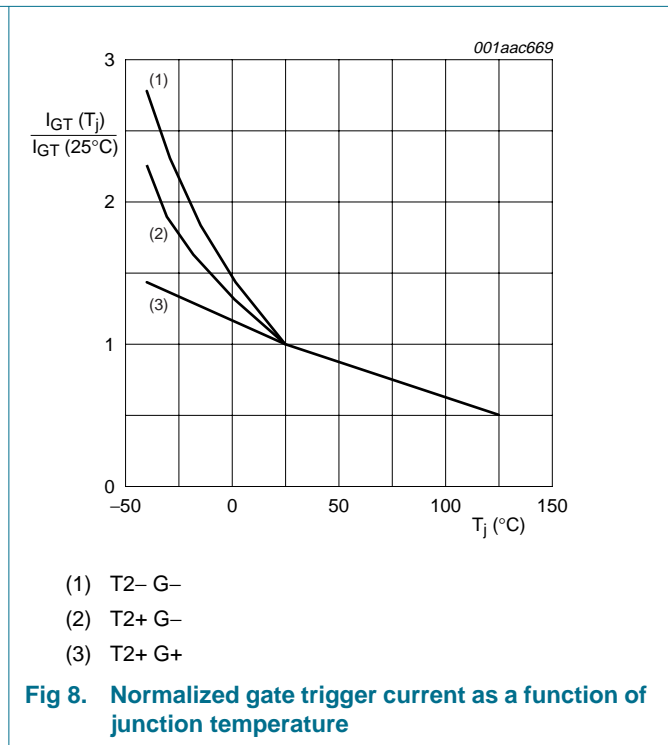
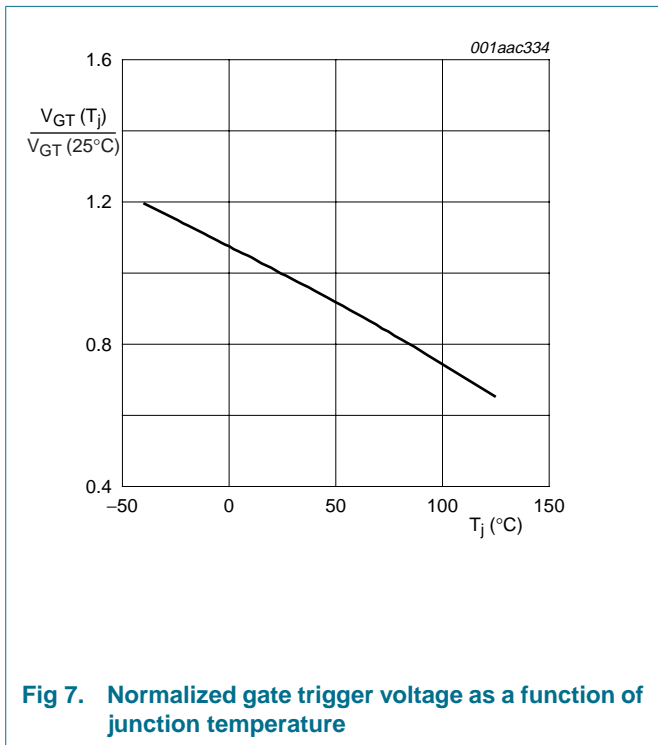

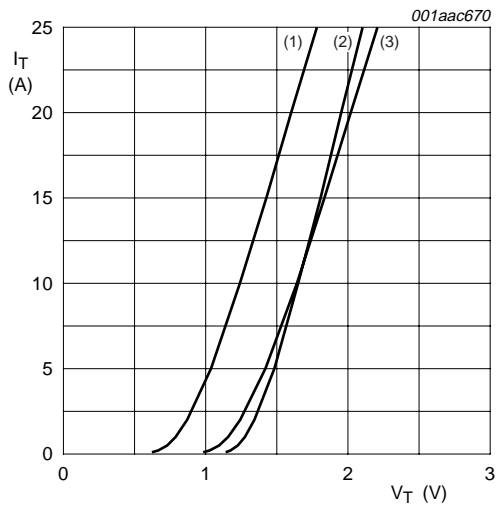

$V_O = 1.264\text{ V}$ ;  $R_S = 37.8\text{ m}\Omega$

- (1)  $T_j = 125^\circ\text{C}$ ; typical values
- (2)  $T_j = 25^\circ\text{C}$ ; maximum values
- (3)  $T_j = 125^\circ\text{C}$ ; maximum values

**Fig 9. On-state characteristic**

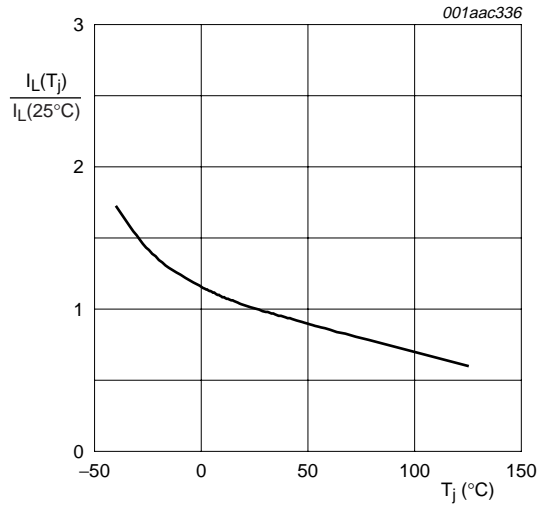

**Fig 10. Normalized latching current as a function of junction temperature**

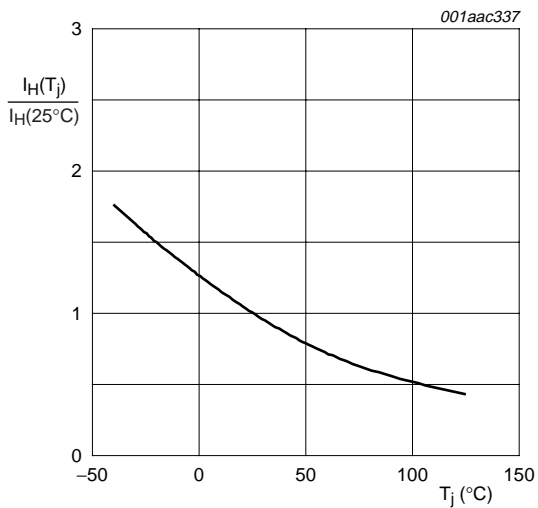

**Fig 11. Normalized holding current as a function of junction temperature**

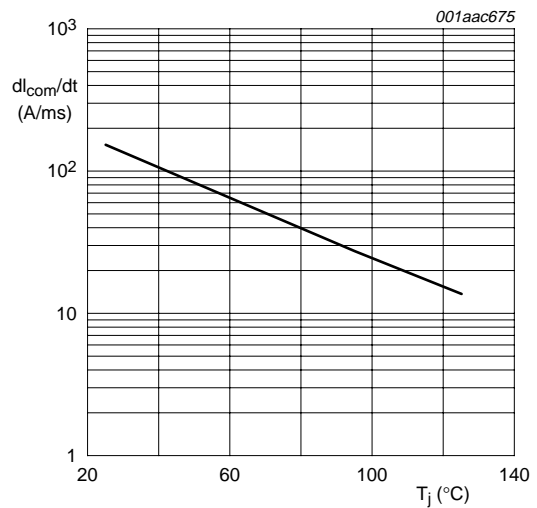

**Fig 12. Rate of rise of commutating current as a function of junction temperature; typical values**

## 8. Package information

Plastic meets UL94 V-0 at 1/8 inch.



**9. Package outline**

Plastic single-ended surface mounted package (DPAK); 3 leads (one lead cropped)

SOT428

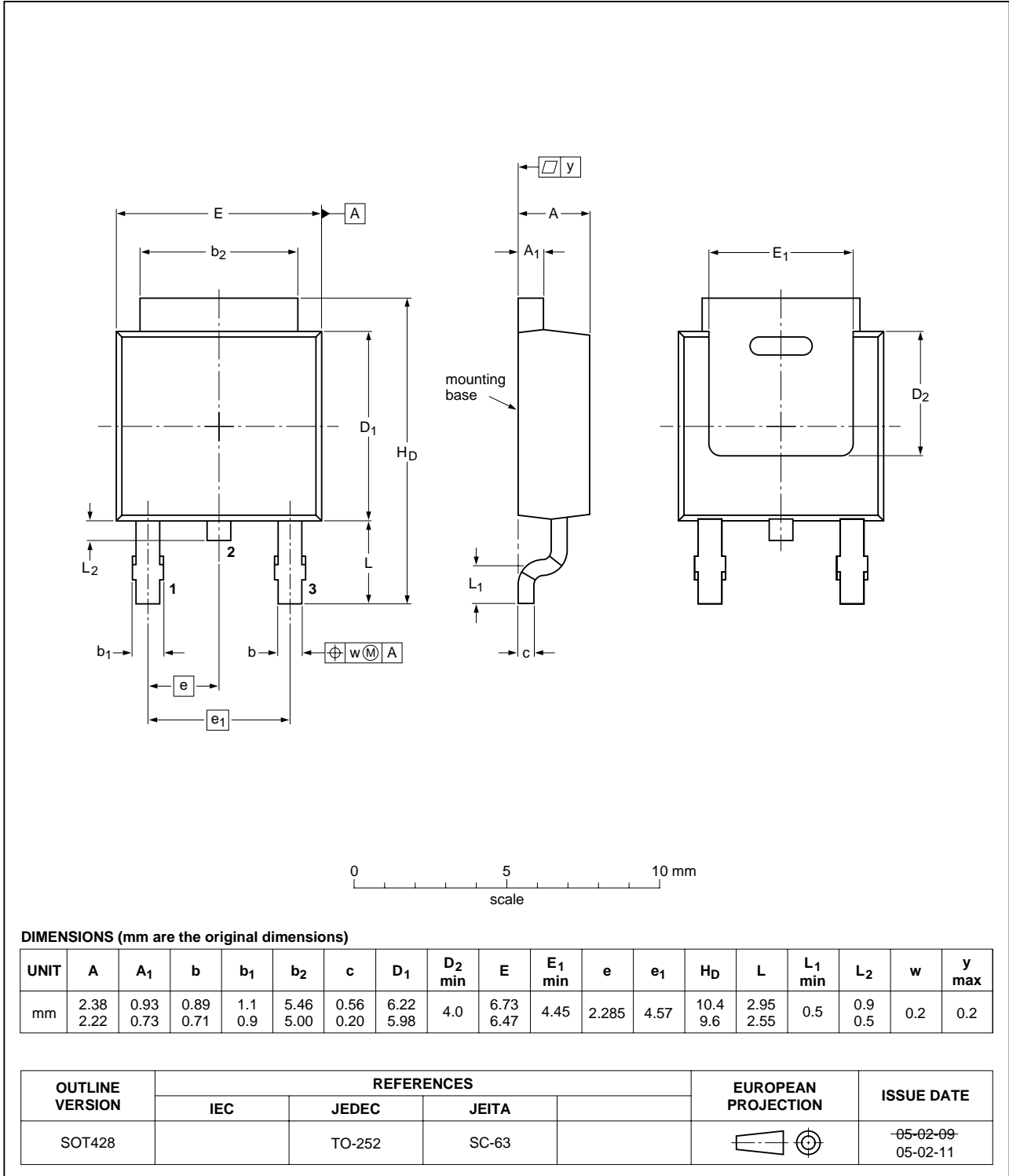
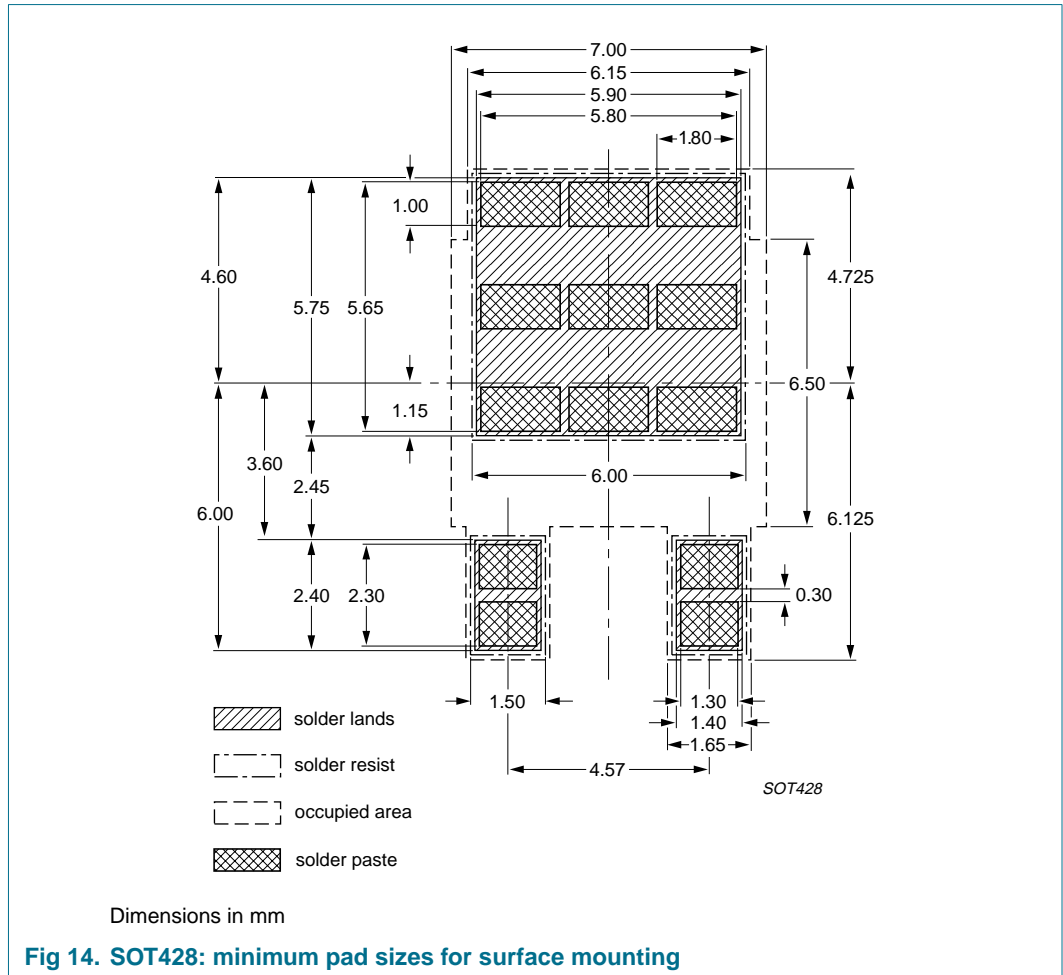

Fig 13. Package outline SOT428 (TO-252)

**10. Mounting**



## 11. Revision history

**Table 7: Revision history**

Document ID	Release date	Data sheet status	Change notice	Doc. number	Supersedes
BTA208S_SER_B_2	20050531	Product data sheet	-	9397 750 14861	BTA208S_SERIES_B_1
Modifications:			<ul style="list-style-type: none"><li>• The format of this data sheet has been redesigned to comply with the new presentation and information standard of Philips Semiconductors.</li><li>• 500 V types removed.</li><li>• Alternative pinning types removed.</li></ul>		
BTA208S_SERIES_B_1	19970901	Product specification	-	-	-

## 12. Data sheet status

Level	Data sheet status <sup>[1]</sup>	Product status <sup>[2] [3]</sup>	Definition
I	Objective data	Development	This data sheet contains data from the objective specification for product development. Philips Semiconductors reserves the right to change the specification in any manner without notice.
II	Preliminary data	Qualification	This data sheet contains data from the preliminary specification. Supplementary data will be published at a later date. Philips Semiconductors reserves the right to change the specification without notice, in order to improve the design and supply the best possible product.
III	Product data	Production	This data sheet contains data from the product specification. Philips Semiconductors reserves the right to make changes at any time in order to improve the design, manufacturing and supply. Relevant changes will be communicated via a Customer Product/Process Change Notification (CPCN).

[1] Please consult the most recently issued data sheet before initiating or completing a design.

[2] The product status of the device(s) described in this data sheet may have changed since this data sheet was published. The latest information is available on the Internet at URL <http://www.semiconductors.philips.com>.

[3] For data sheets describing multiple type numbers, the highest-level product status determines the data sheet status.

## 13. Definitions

**Short-form specification** — The data in a short-form specification is extracted from a full data sheet with the same type number and title. For detailed information see the relevant data sheet or data handbook.

**Limiting values definition** — Limiting values given are in accordance with the Absolute Maximum Rating System (IEC 60134). Stress above one or more of the limiting values may cause permanent damage to the device. These are stress ratings only and operation of the device at these or at any other conditions above those given in the Characteristics sections of the specification is not implied. Exposure to limiting values for extended periods may affect device reliability.

**Application information** — Applications that are described herein for any of these products are for illustrative purposes only. Philips Semiconductors make no representation or warranty that such applications will be suitable for the specified use without further testing or modification.

## 14. Disclaimers

**Life support** — These products are not designed for use in life support appliances, devices, or systems where malfunction of these products can reasonably be expected to result in personal injury. Philips Semiconductors

## 16. Contact information

For additional information, please visit: <http://www.semiconductors.philips.com>

For sales office addresses, send an email to: [sales.addresses@www.semiconductors.philips.com](mailto:sales.addresses@www.semiconductors.philips.com)

customers using or selling these products for use in such applications do so at their own risk and agree to fully indemnify Philips Semiconductors for any damages resulting from such application.

**Right to make changes** — Philips Semiconductors reserves the right to make changes in the products - including circuits, standard cells, and/or software - described or contained herein in order to improve design and/or performance. When the product is in full production (status 'Production'), relevant changes will be communicated via a Customer Product/Process Change Notification (CPCN). Philips Semiconductors assumes no responsibility or liability for the use of any of these products, conveys no license or title under any patent, copyright, or mask work right to these products, and makes no representations or warranties that these products are free from patent, copyright, or mask work right infringement, unless otherwise specified.

## 15. Trademarks

**Notice** — All referenced brands, product names, service names and trademarks are the property of their respective owners.

## 17. Contents

---

<b>1</b>	<b>Product profile</b> . . . . .	<b>1</b>
1.1	General description. . . . .	1
1.2	Features . . . . .	1
1.3	Quick reference data. . . . .	1
<b>2</b>	<b>Pinning information</b> . . . . .	<b>1</b>
<b>3</b>	<b>Ordering information</b> . . . . .	<b>2</b>
<b>4</b>	<b>Limiting values</b> . . . . .	<b>2</b>
<b>5</b>	<b>Thermal characteristics</b> . . . . .	<b>5</b>
<b>6</b>	<b>Static characteristics</b> . . . . .	<b>6</b>
<b>7</b>	<b>Dynamic characteristics</b> . . . . .	<b>7</b>
<b>8</b>	<b>Package information</b> . . . . .	<b>8</b>
<b>9</b>	<b>Package outline</b> . . . . .	<b>9</b>
<b>10</b>	<b>Mounting</b> . . . . .	<b>10</b>
<b>11</b>	<b>Revision history</b> . . . . .	<b>11</b>
<b>12</b>	<b>Data sheet status</b> . . . . .	<b>12</b>
<b>13</b>	<b>Definitions</b> . . . . .	<b>12</b>
<b>14</b>	<b>Disclaimers</b> . . . . .	<b>12</b>
<b>15</b>	<b>Trademarks</b> . . . . .	<b>12</b>
<b>16</b>	<b>Contact information</b> . . . . .	<b>12</b>



© Koninklijke Philips Electronics N.V. 2005

All rights are reserved. Reproduction in whole or in part is prohibited without the prior written consent of the copyright owner. The information presented in this document does not form part of any quotation or contract, is believed to be accurate and reliable and may be changed without notice. No liability will be accepted by the publisher for any consequence of its use. Publication thereof does not convey nor imply any license under patent- or other industrial or intellectual property rights.

Date of release: 31 May 2005  
Document number: 9397 750 14861

Published in The Netherlands