

# L200-0CW-40D-LL

Super Cool White

5mm, Flanged Cylindrical, 8.6mm Height  
40° viewing angle

DWG BY:  
LL / GP  
10-19-07

CHK BY:  
PL  
10-22-07

QA:  
—  
— — —

MFG:  
—  
— — —

REVISION LTR: -  
10-19-07

Part No.	L200-0CW-40D-LL	DWG NO.	DSDC0623	Page	1 of 4
----------	-----------------	---------	----------	------	--------

**Features:**

- High intensity
- Standard 5mm diameter package
- Tinned leads
- Pb-free

**Package Dimensions:**

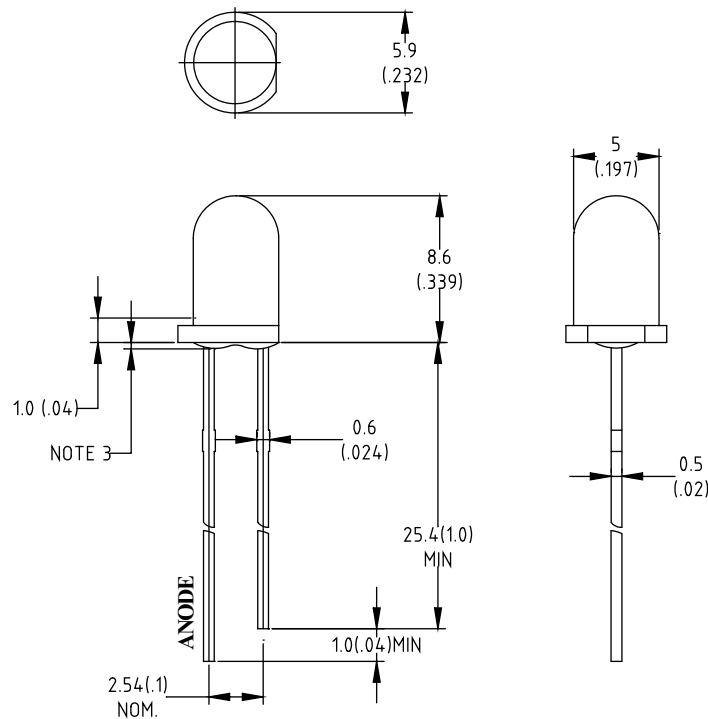

Part No.	Chip Material	Lens Color	Emission Color
L200-0CW-40D-LL	InGaN	Water Clear	Super Cool White

**Notes:**

1. All dimensions are in millimeters (inches).
2. Tolerance is  $\pm 0.25\text{mm}$  (.010") unless otherwise noted.
3. Protruded resin under flange is 1.0mm (.04") max.
4. Lead spacing is measured where the leads emerge from the package.
5. Specifications are subject to change without notice.
6. Precautions for ESD: Static electricity and surge can damage the LED. It is recommended to use a wristband or anti-electrostatic glove when handling the LED. All devices, equipment and machinery must be properly grounded.

### Absolute Maximum Ratings at Ta=25°C

Parameter	MAX.	Unit
Power Dissipation	80	mW
Peak Forward Current (1/10 Duty Cycle, 0.1ms Pulse Width)	100	mA
Continuous Forward Current	20	mA
Derating Linear From 50°C	0.4	mA/°C
Reverse Voltage	5	V
Electrostatic Discharge (ESD)	150	V
Operating Temperature Range	-20°C to +80°C	
Storage Temperature Range	-30°C to +100°C	
Lead Soldering Temperature [4mm (.157") From Body]	260°C for 5 Seconds	

### Electrical Optical Characteristics at Ta=25°C

Parameter	Symbol	Min.	Typ.	Max.	Unit	Test Condition
Luminous Intensity	I <sub>V</sub>	3000	7200	---	mcd	I <sub>F</sub> =20mA (Note 1)
Viewing Angle	2θ <sub>1/2</sub>	34	40	---	Deg	(Note 2)
Forward Voltage	V <sub>F</sub>	---	3.2	4.0	V	I <sub>F</sub> =20mA
Reverse Current	I <sub>R</sub>	---	---	50	μA	V <sub>R</sub> =5V
SCP	---	---	0.28	---	cd	---
Lumens	---	---	3.6	---	lm	---
Radiant Intensity	---	---	25	---	mW/sr	---
Color Rendering Index	(CRI)	79	---	83	---	---

Color Rank	x	y	x	y	x	y	x	y
LTC & LTD	0.270	0.285	0.288	0.250	0.305	0.275	0.295	0.325

**Notes:**

- Luminous intensity is measured with a light sensor and filter combination that approximates the CIE eye-response curve.
- $\theta_{1/2}$  is the off-axis angle at which the luminous intensity is half the axial luminous intensity.
- Forward voltage measurement allowance is  $\pm 0.1V$
- Luminous Intensity Measurement Allowance is  $\pm 10\%$ .

**Typical Electrical / Optical Characteristics Curves  
 (25°C Ambient Temperature Unless Otherwise Noted)**

**CIE 1931 Chromaticity Diagram**

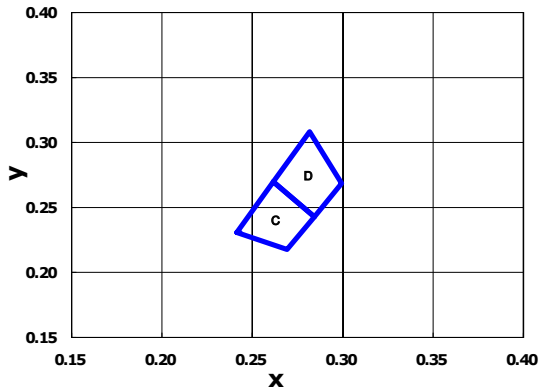

**Spectral Radiance**

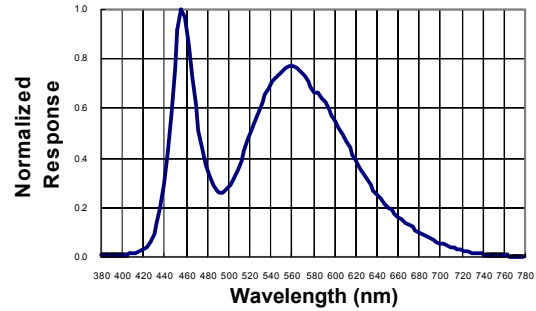

**Relative Intensity vs Forward Current**

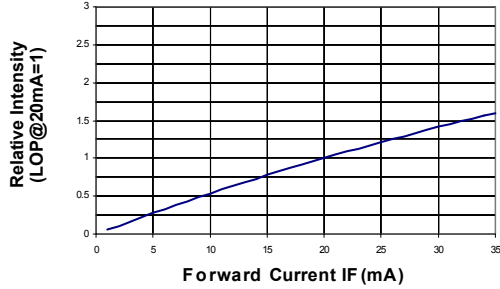

**Forward Current vs Forward Voltage**

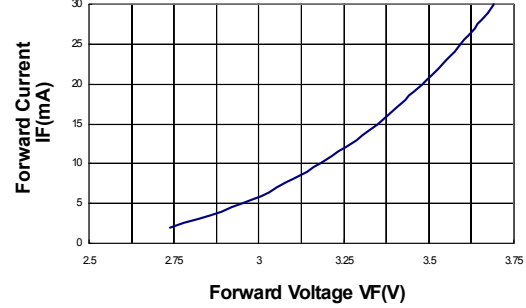

**Forward Current vs. Chromaticity coordinate**

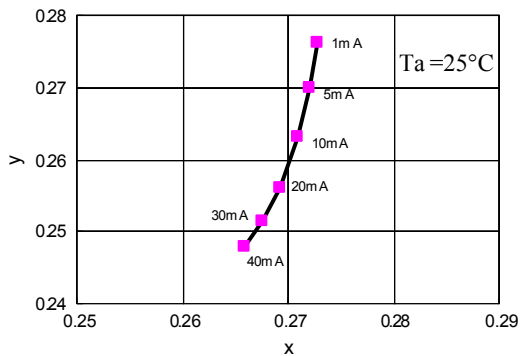

**Forward Current Derating Curve**

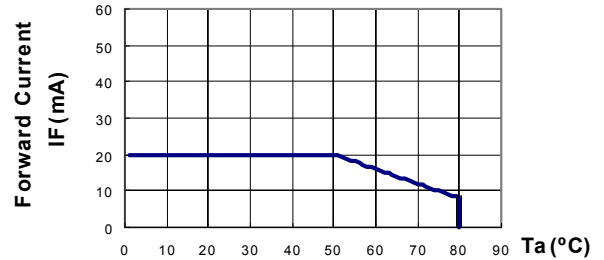

**Beam Pattern**

