



# 2-Cell, Stand-Alone, Li+ Fuel-Gauge IC with Protector and Optional SHA-1 Authentication

## General Description

The DS2775–DS2778 report available capacity for rechargeable lithium-ion (Li+) and Li+ polymer (Li-Poly) batteries in mAh and as a percentage of full. Safe operation is ensured by the integrated Li+ protector. The DS2776/DS2778 support SHA-1-based challenge-response authentication in addition to all other DS2775/DS2777 features.

Precision measurements of voltage, temperature, and current, along with a cell characteristics table and application parameters, are used for capacity estimation calculations. The capacity registers report a conservative estimate of the amount of charge that can be removed given the current temperature, discharge rate, stored charge, and application parameters.

The DS2775–DS2778 operate from +4.0V to +9.2V for direct integration into battery packs with two Li+ or Li-Poly cells.

In addition to nonvolatile storage for cell compensation and application parameters, the DS2775–DS2778 offer 16 bytes of EEPROM for use by the host system and/or pack manufacturer to store battery lot and date tracking information. The EEPROM can also be used for non-volatile storage of system and/or battery usage statistics. A Maxim 1-Wire® (DS2775/DS2776) or 2-wire (DS2777/DS2778) interface provides serial communication to access measurement and capacity data registers, control registers, and user memory. The DS2776/DS2778 use the SHA-1 hash algorithm in a challenge-response pack authentication protocol for battery-pack verification.

## Applications

Low-Cost Notebooks  
UMPCs  
DSLR Cameras  
Video Cameras  
Commercial and Military Radios  
Portable Medical Equipment

Selector Guide appears at end of data sheet.

1-Wire is a registered trademark of Maxim Integrated Products, Inc.



Maxim Integrated Products 1

For pricing, delivery, and ordering information, please contact Maxim Direct at 1-888-629-4642 or visit Maxim's website at [www.maxim-ic.com](http://www.maxim-ic.com).

www.DataSheet4U.com

## Features

- ◆ High-Side nFET Drivers and Protection Circuitry
- ◆ Precision Voltage, Temperature, and Current Measurement System
- ◆ Cell-Capacity Estimation from Coulomb Count, Discharge Rate, Temperature, and Cell Characteristics
- ◆ Estimates Cell Aging Between Learn Cycles
- ◆ Uses Low-Cost Sense Resistor
- ◆ Allows Calibration of Gain and Temperature Coefficient
- ◆ Programmable Thresholds for Overvoltage and Overcurrent
- ◆ Pack Authentication Using SHA-1 Algorithm (DS2776/DS2778)
- ◆ 32-Byte Parameter EEPROM
- ◆ 16-Byte User EEPROM
- ◆ Maxim 1-Wire Interface with 64-Bit Unique ID (DS2775/DS2776)
- ◆ 2-Wire Interface with 64-Bit Unique ID (DS2777/DS2778)
- ◆ 3mm x 5mm, 14-pin TDFN Lead-Free Package

## Ordering Information

PART	PIN-PACKAGE	TOP MARK
DS2775G+	14 TDFN-EP*	D2775
DS2775G+T&R	14 TDFN-EP*	D2775
DS2776G+	14 TDFN-EP*	D2776
DS2776G+T&R	14 TDFN-EP*	D2776
DS2777G+	14 TDFN-EP*	D2777
DS2777G+T&R	14 TDFN-EP*	D2777
DS2778G+	14 TDFN-EP*	D2778
DS2778G+T&R	14 TDFN-EP*	D2778

**Note:** All devices are specified over the -20°C to +70°C operating temperature range.

+Denotes a lead(Pb)-free/RoHS-compliant package.

T&R = Tape and reel.

\*EP = Exposed pad.

DS2775/DS2776/DS2777/DS2778

# 2-Cell, Stand-Alone, Li+ Fuel-Gauge IC with Protector and Optional SHA-1 Authentication

## ABSOLUTE MAXIMUM RATINGS

Voltage Range on PLS, CP, CC, DC Pins Relative to V <sub>SS</sub> .....	-0.3V to +18V	Continuous Sink Current, PIO, DQ.....	20mA
Voltage Range on V <sub>DD</sub> , V <sub>IN1</sub> , V <sub>IN2</sub> , SRC Pins Relative to V <sub>SS</sub> .....	-0.3V to +9.2V	Continuous Sink Current, CC, DC.....	10mA
Voltage Range on All Other Pins Relative to V <sub>SS</sub> ...	-0.3V to +6.0V	Operating Temperature Range .....	-20°C to +70°C
		Storage Temperature Range .....	-55°C to +125°C
		Lead Temperature (soldering, 10s) .....	+300°C
		Soldering Temperature (reflow) .....	+260°C

Stresses beyond those listed under "Absolute Maximum Ratings" may cause permanent damage to the device. These are stress ratings only, and functional operation of the device at these or any other conditions beyond those indicated in the operational sections of the specifications is not implied. Exposure to absolute maximum rating conditions for extended periods may affect device reliability.

## ELECTRICAL CHARACTERISTICS

(V<sub>DD</sub> = +4.0V to +9.2V, T<sub>A</sub> = -20°C to +70°C, unless otherwise noted. Typical values are at T<sub>A</sub> = +25°C.)

PARAMETER	SYMBOL	CONDITIONS	MIN	TYP	MAX	UNITS
Supply Current	I <sub>DD0</sub>	Sleep mode, T <sub>A</sub> ≤ +50°C		3	5	μA
		Sleep mode, T <sub>A</sub> > +50°C			10	
	I <sub>DD1</sub>	Active mode		80	135	
	I <sub>DD2</sub>	Active mode during SHA-1 computation		120	300	
Temperature Accuracy	T <sub>ERR</sub>		-3		+3	°C
Voltage Accuracy		2.0 ≤ V <sub>IN1</sub> ≤ 4.6, 2.0 ≤ (V <sub>IN2</sub> - V <sub>IN1</sub> ) ≤ 4.6, 0°C ≤ T <sub>A</sub> ≤ +50°C	-35		+35	mV
		2.0 ≤ V <sub>IN1</sub> ≤ 4.6, 2.0 ≤ (V <sub>IN2</sub> - V <sub>IN1</sub> ) ≤ 4.6, T <sub>A</sub> = +25°C	-22		22	
		2.0 ≤ V <sub>IN1</sub> ≤ 4.6, 2.0 ≤ (V <sub>IN2</sub> - V <sub>IN1</sub> ) ≤ 4.6	-50		+50	
Input Resistance (V <sub>IN1</sub> , V <sub>IN2</sub> )			15			MΩ
Current Resolution	I <sub>LSB</sub>			1.56		μV
Current Full Scale	I <sub>FS</sub>		-51.2		+51.2	mV
Current Gain Error	I <sub>GERR</sub>		-1		+1	% FS
Current Offset	I <sub>OERR</sub>	0°C ≤ T <sub>A</sub> ≤ +70°C (Note 1)	-9.375		9.375	μVh
Accumulated Current Offset	Q <sub>OERR</sub>	0°C ≤ T <sub>A</sub> ≤ +70°C (Note 1)	-255		0	μVh/Day
Time-Base Error	t <sub>ERR</sub>	0°C ≤ T <sub>A</sub> ≤ +50°C	-2		+2	%
			-3		+3	
CP Output Voltage (V <sub>CP</sub> - V <sub>SRC</sub> )	V <sub>GS</sub>	I <sub>OUT</sub> = 0.9μA	4.4	4.7	5	V
CP Startup Time	t <sub>SCP</sub>	CE = 0, DE = 0, C <sub>CP</sub> = 0.1μF, active mode			200	ms
Output High: CC, DC	V <sub>OHCP</sub>	I <sub>OH</sub> = 100μA (Note 2)	V <sub>CP</sub> - 0.4			V
Output Low: CC	V <sub>OLCC</sub>	I <sub>OL</sub> = 100μA		V <sub>SRC</sub> + 0.1		V
Output Low: DC	V <sub>OLDC</sub>	I <sub>OL</sub> = 100μA		V <sub>SRC</sub> + 0.1		V
DQ, PIO Voltage Range			-0.3		+5.5	V
DQ, PIO, SDA, SCL Input Logic-High	V <sub>IH</sub>		1.5			V
DQ, PIO, SDA, SCL Input Logic-Low	V <sub>IL</sub>				0.6	V
OVD Input Logic-High	V <sub>IH</sub>		V <sub>BAT</sub> - 0.2			V
OVD Input Logic-Low	V <sub>IL</sub>				V <sub>SS</sub> + 0.2	V

## 2-Cell, Stand-Alone, Li+ Fuel-Gauge IC with Protector and Optional SHA-1 Authentication

### ELECTRICAL CHARACTERISTICS (continued)

( $V_{DD} = +4.0V$  to  $+9.2V$ ,  $T_A = -20^{\circ}C$  to  $+70^{\circ}C$ , unless otherwise noted. Typical values are at  $T_A = +25^{\circ}C$ .)

PARAMETER	SYMBOL	CONDITIONS	MIN	TYP	MAX	UNITS
DQ, PIO, SDA Output Logic-Low	$V_{OL}$	$I_{OL} = 4mA$			0.4	V
DQ, PIO Pullup Current	$I_{PU}$	Sleep mode, $V_{PIN} = (V_{DD} - 0.4V)$	30	100	200	nA
DQ, PIO, SDA, SCL Pulldown Current	$I_{PD}$	Active mode, $V_{PIN} = 0.4V$	30	100	200	nA
DQ Input Capacitance	$C_{DQ}$			50		pF
DQ Sleep Timeout	$t_{SLEEP}$	$DQ < V_{IL}$	2		9	s
PIO, DQ Wake Debounce	$t_{WDB}$	Sleep mode		100		ms

### SHA-1 COMPUTATION TIMING (DS2776/DS2778 ONLY)

( $V_{DD} = +4.0V$  to  $+9.2V$ ,  $T_A = 0^{\circ}C$  to  $+70^{\circ}C$ , unless otherwise noted. Typical values are at  $T_A = +25^{\circ}C$ .)

PARAMETER	SYMBOL	CONDITIONS	MIN	TYP	MAX	UNITS
Computation Time	$t_{COMP}$				30	ms

### ELECTRICAL CHARACTERISTICS: PROTECTION CIRCUIT

( $V_{DD} = +4.0V$  to  $+9.2V$ ,  $T_A = 0^{\circ}C$  to  $+50^{\circ}C$ , unless otherwise noted. Typical values are at  $T_A = +25^{\circ}C$ .)

PARAMETER	SYMBOL	CONDITIONS	MIN	TYP	MAX	UNITS
Overvoltage Detect	$V_{OV}$	$V_{OV} = 1110111b$	4.438	4.473	4.508	V
		$V_{OV} = 1100011b$	4.242	4.277	4.312	
Charge-Enable Voltage	$V_{CE}$	Relative to $V_{OV}$		-100		mV
Undervoltage Detect	$V_{UV}$	Programmable in Control register 0x60h, $UV[1:0] = 10$	2.415	2.450	2.485	V
Overcurrent Detect: Charge	$V_{COC}$	OC = 11b	-60	-75	-90	mV
		OC = 00b	-12.5	-25	-38	
Overcurrent Detect: Discharge	$V_{DOC}$	OC = 11b	80	100	120	mV
		OC = 00b	25	38	50	
Short-Circuit Current Detect	$V_{SC}$	SC = 1b	240	300	360	mV
		SC = 0b	120	150	180	
Overvoltage Delay	$t_{OVD}$	(Note 3)	600		1400	ms
Undervoltage Delay	$t_{UVD}$	(Note 3)	600		1400	ms
Overcurrent Delay	$t_{OCD}$		8	10	12	ms
Short-Circuit Delay	$t_{SCD}$		80	120	160	$\mu s$
Charger-Detect Hysteresis	$V_{CD}$	$V_{UV}$ condition		50		mV
Test Threshold	$V_{TP}$	COC, DOC condition	0.4	1.0	1.2	V
Test Current	$I_{TST}$	DOC condition	20	40	80	$\mu A$
		COC condition	-45	-60	-95	
PLS Pulldown Current	$I_{PPD}$	Sleep mode	200	400	630	$\mu A$
Recovery Current	$I_{RC}$	$V_{UV}$ condition, max: $V_{PLS} = 15V$ , $V_{DD} = 1.4V$ ; min: $V_{PLS} = 4.2V$ , $V_{DD} = 2V$	3.3	8	13	mA

## 2-Cell, Stand-Alone, Li+ Fuel-Gauge IC with Protector and Optional SHA-1 Authentication

**DS2775/DS2776/DS2777/DS2778**

### EEPROM RELIABILITY SPECIFICATION

( $V_{DD} = +4.0V$  to  $+9.2V$ ,  $T_A = -20^{\circ}C$  to  $+70^{\circ}C$ , unless otherwise noted.)

PARAMETER	SYMBOL	CONDITIONS	MIN	TYP	MAX	UNITS
EEPROM Copy Time	$t_{EEC}$				10	ms
EEPROM Copy Endurance	$N_{EEC}$	$T_A = +50^{\circ}C$	50,000			Cycles

### ELECTRICAL CHARACTERISTICS: 1-Wire INTERFACE, STANDARD (DS2775/DS2776 ONLY)

( $V_{DD} = +4.0V$  to  $+9.2V$ ,  $T_A = -20^{\circ}C$  to  $+70^{\circ}C$ .)

PARAMETER	SYMBOL	CONDITIONS	MIN	TYP	MAX	UNITS
Time Slot	$t_{SLOT}$		60		120	$\mu s$
Recovery Time	$t_{REC}$		1			$\mu s$
Write-Zero Low Time	$t_{LOW0}$		60		120	$\mu s$
Write-One Low Time	$t_{LOW1}$		1		15	$\mu s$
Read Data Valid	$t_{RDV}$				15	$\mu s$
Reset Time High	$t_{RSTH}$		480			$\mu s$
Reset Time Low	$t_{RSTL}$		480		960	$\mu s$
Presence-Detect High	$t_{PDH}$		15		60	$\mu s$
Presence-Detect Low	$t_{PDL}$		60		240	$\mu s$

### ELECTRICAL CHARACTERISTICS: 1-Wire INTERFACE, OVERDRIVE (DS2775/DS2776 ONLY)

( $V_{DD} = +4.0V$  to  $+9.2V$ ,  $T_A = -20^{\circ}C$  to  $+70^{\circ}C$ .)

PARAMETER	SYMBOL	CONDITIONS	MIN	TYP	MAX	UNITS
Time Slot	$t_{SLOT}$		6		16	$\mu s$
Recovery Time	$t_{REC}$		1			$\mu s$
Write-Zero Low Time	$t_{LOW0}$		6		16	$\mu s$
Write-One Low Time	$t_{LOW1}$		1		2	$\mu s$
Read Data Valid	$t_{RDV}$				2	$\mu s$
Reset Time High	$t_{RSTH}$		48			$\mu s$
Reset Time Low	$t_{RSTL}$		48		80	$\mu s$
Presence-Detect High	$t_{PDH}$		2		6	$\mu s$
Presence-Detect Low	$t_{PDL}$		8		24	$\mu s$

## 2-Cell, Stand-Alone, Li+ Fuel-Gauge IC with Protector and Optional SHA-1 Authentication

### ELECTRICAL CHARACTERISTICS: 2-WIRE INTERFACE (DS2777/DS2778 ONLY)

( $V_{DD} = +4.0V$  to  $+9.2V$ ,  $T_A = -20^{\circ}C$  to  $+70^{\circ}C$ .)

PARAMETER	SYMBOL	CONDITIONS	MIN	TYP	MAX	UNITS
SCL Clock Frequency	$f_{SCL}$	(Note 4)	0		400	kHz
Bus-Free Time Between a STOP and START Condition	$t_{BUF}$		1.3			$\mu s$
Hold Time (Repeated) START Condition	$t_{HD:STA}$	(Note 5)	0.6			$\mu s$
Low Period of SCL Clock	$t_{LOW}$		1.3			$\mu s$
High Period of SCL Clock	$t_{HIGH}$		0.6			$\mu s$
Setup Time for a Repeated START Condition	$t_{SU:STA}$		0.6			$\mu s$
Data Hold Time	$t_{HD:DAT}$	(Notes 6, 7)	0		0.9	$\mu s$
Data Setup Time	$t_{SU:DAT}$	(Note 6)	100			ns
Rise Time of Both SDA and SCL Signals	$t_R$		20 + 0.1 $C_B$		300	ns
Fall Time of Both SDA and SCL Signals	$t_F$		20 + 0.1 $C_B$		300	ns
Setup Time for STOP Condition	$t_{SU:STO}$		0.6			$\mu s$
Spike Pulse Widths Suppressed by Input Filter	$t_{SP}$	(Note 8)	0		50	ns
Capacitive Load for Each Bus Line	$C_B$	(Note 9)			400	pF
SCL, SDA Input Capacitance	$C_{BIN}$				60	pF

**Note 1:** Accumulation bias and offset bias registers set to 00h. NBEN bit set to 0.

**Note 2:** Measurement made with  $V_{SRC} = +8V$ ,  $V_{GS}$  driven with external +4.5V supply.

**Note 3:** Overvoltage (OV) and undervoltage (UV) delays ( $t_{OVD}$ ,  $t_{UVD}$ ) are reduced to zero seconds if the OV or UV condition is detected within 100ms of entering active mode.

**Note 4:** Timing must be fast enough to prevent the DS2777/DS2778 from entering sleep mode due to bus low for period  $> t_{SLEEP}$ .

**Note 5:**  $f_{SCL}$  must meet the minimum clock low time plus the rise/fall times.

**Note 6:** The maximum  $t_{HD:DAT}$  need only be met if the device does not stretch the low period ( $t_{LOW}$ ) of the SCL signal.

**Note 7:** This device internally provides a hold time of at least 75ns for the SDA signal (referred to the  $V_{HMIN}$  of the SCL signal) to bridge the undefined region of the falling edge of SCL.

**Note 8:** Filters on SDA and SCL suppress noise spikes at the input buffers and delay the sampling instant.

**Note 9:**  $C_B$  is total capacitance of one bus line in pF.

DS2775/DS2776/DS2777/DS2778

# 2-Cell, Stand-Alone, Li+ Fuel-Gauge IC with Protector and Optional SHA-1 Authentication

## Typical Operating Characteristics

( $T_A = +25^\circ\text{C}$ , unless otherwise noted.)

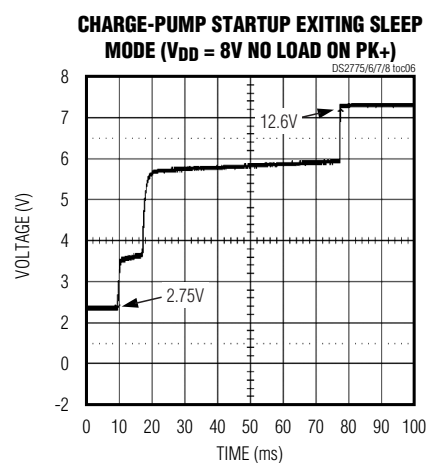
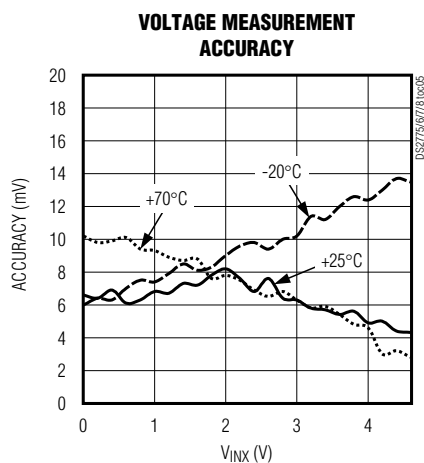
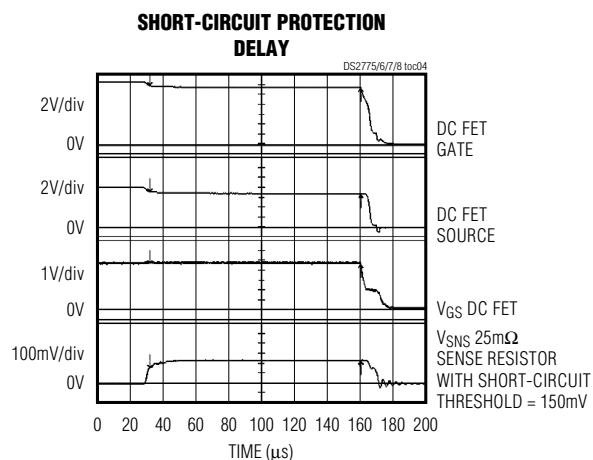
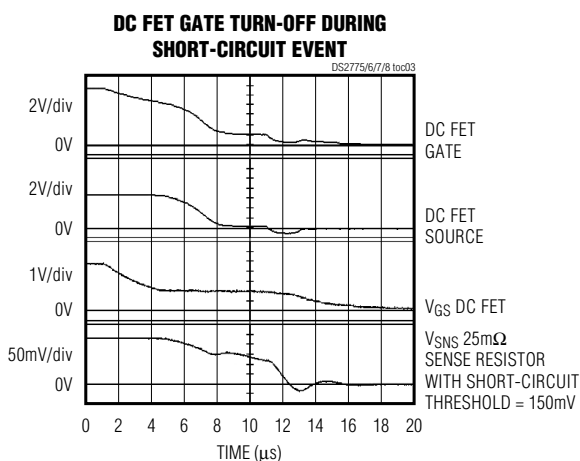
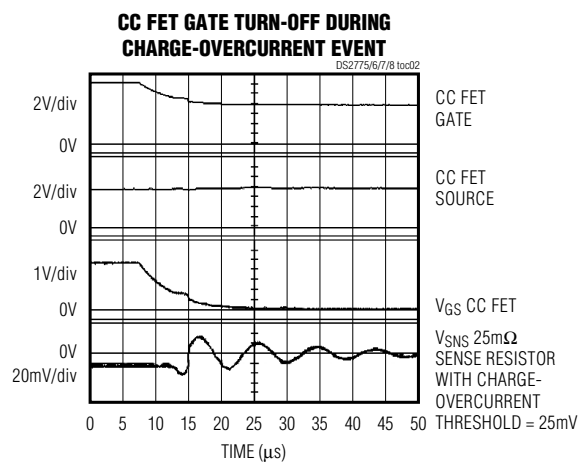
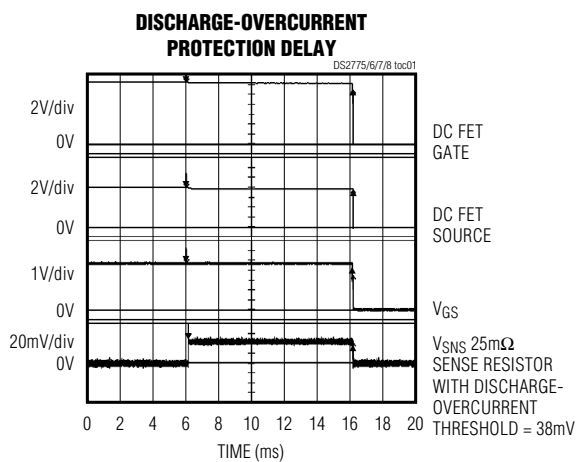

# 2-Cell, Stand-Alone, Li+ Fuel-Gauge IC with Protector and Optional SHA-1 Authentication

## Typical Operating Characteristics (continued)

(T<sub>A</sub> = +25°C, unless otherwise noted.)

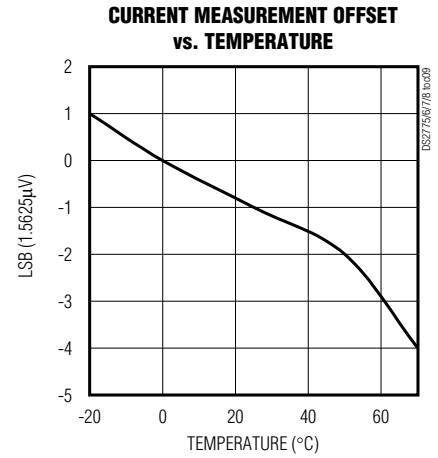
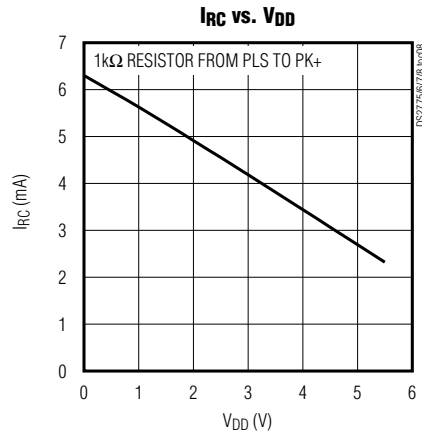
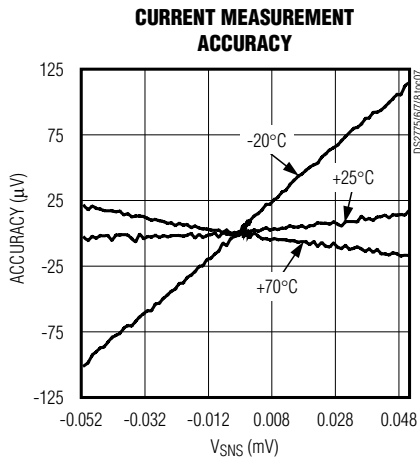

DS2775/DS2776/DS2777/DS2778

# 2-Cell, Stand-Alone, Li+ Fuel-Gauge IC with Protector and Optional SHA-1 Authentication

## Pin Configuration

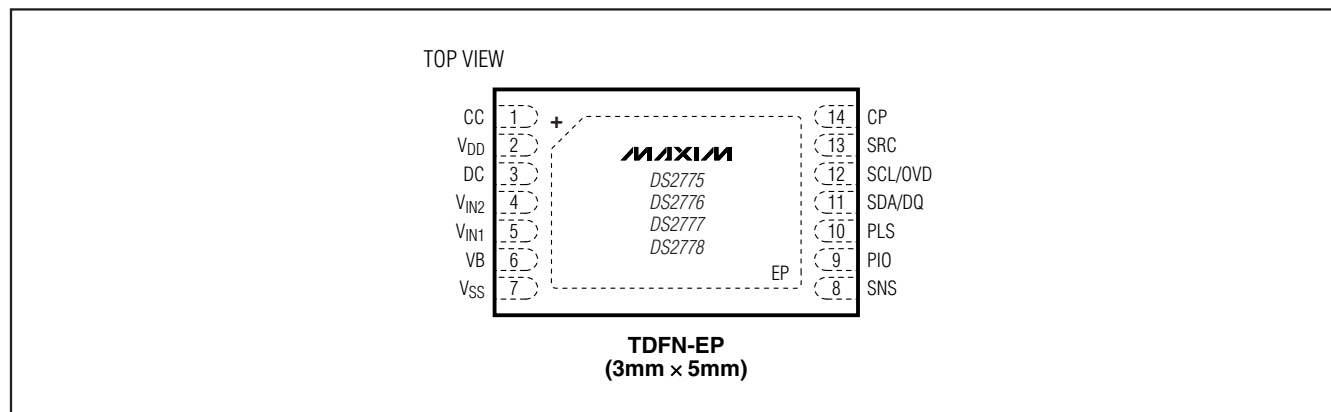

## Pin Description

PIN	NAME	FUNCTION
1	CC	Charge Control. Charge FET control output.
2	V <sub>DD</sub>	Chip-Supply Input. Bypass with 0.1μF to V <sub>SS</sub> .
3	DC	Discharge Control. Discharge FET control output.
4	V <sub>IN2</sub>	Battery Voltage Sense Input 2. Connect to highest voltage potential positive cell terminal through decoupling network.
5	V <sub>IN1</sub>	Battery Voltage Sense Input 1. Connect to lowest voltage potential positive cell terminal through decoupling network.
6	VB	Regulated Operating Voltage. Bypass with 0.1μF to V <sub>SS</sub> .
7	V <sub>SS</sub>	Device Ground. Chip ground and battery-side sense resistor input.
8	SNS	Sense Resistor Connection. Pack-side sense resistor sense input.
9	PIO	Programmable I/O. Can be configured as wake input.
10	PLS	Pack Plus Terminal Sense Input. Used to detect the removal of short-circuit, discharge overcurrent, and charge overcurrent conditions.
11	SDA/DQ	Data Input/Output. Serial data I/O, includes weak pulldown to detect system disconnect and can be configured as wake input for 1-Wire devices.
12	SCL/OVD	Serial Clock Input/Overdrive Select. Communication clock for 2-wire devices/overdrive select pin for 1-Wire devices.
13	SRC	Protection MOSFET Source Connection. Used as a reference for the charge pump.
14	CP	Charge Pump Output. Generates gate drive voltage for protection FETs. Bypass with 0.47μF to SRC.
—	EP	Exposed Pad. Connect to ground or no connection.



# 2-Cell, Stand-Alone, Li+ Fuel-Gauge IC with Protector and Optional SHA-1 Authentication

**Block Diagram**

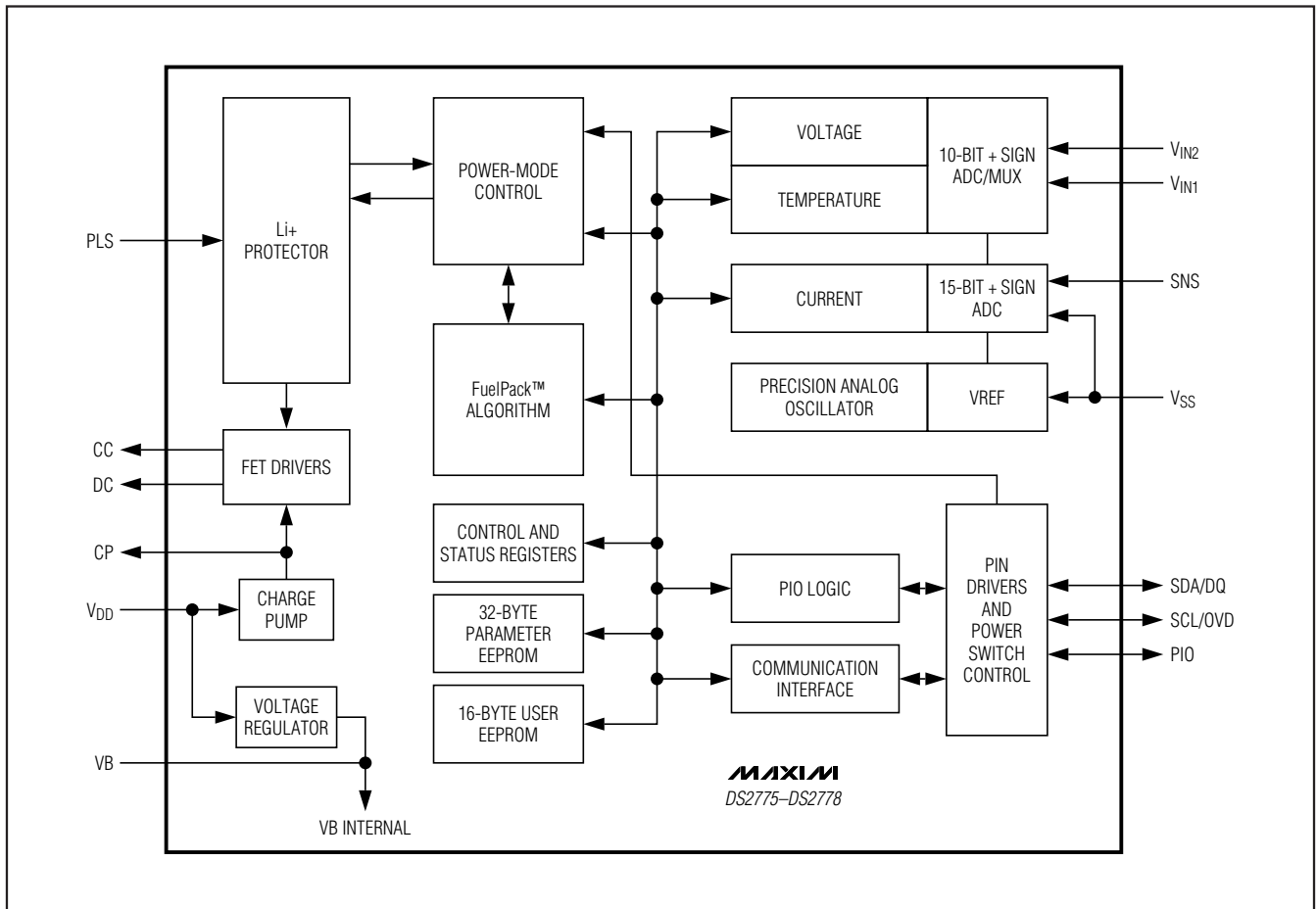

DS2775/DS2776/DS2777/DS2778

# 2-Cell, Stand-Alone, Li+ Fuel-Gauge IC with Protector and Optional SHA-1 Authentication

DS2775/DS2776/DS2777/DS2778

## DS2775/DS2776 Typical Application Circuit

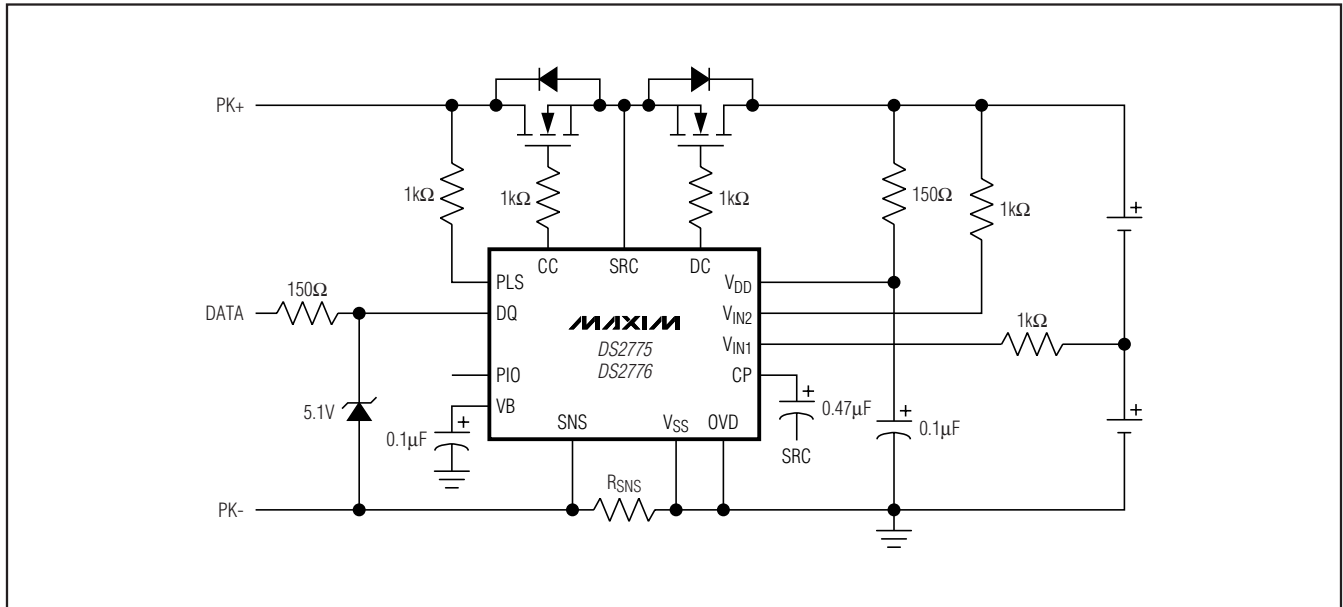

## DS2777/DS2778 Typical Application Circuit

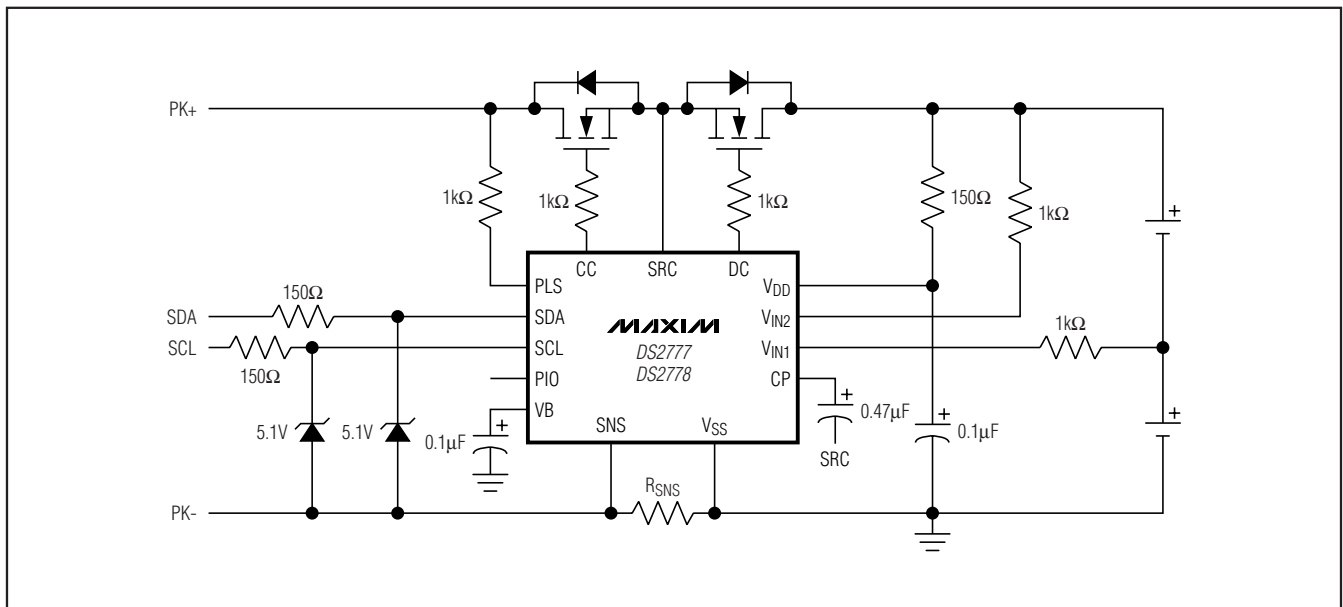

# 2-Cell, Stand-Alone, Li+ Fuel-Gauge IC with Protector and Optional SHA-1 Authentication

DS2775/DS2776/DS2777/DS2778

## Detailed Description

The DS2775–DS2778 function as an accurate fuel gauge, Li+ protector, and SHA-1-based authentication token (SHA-1-based authentication available only on the DS2776/DS2778). The fuel gauge provides accurate estimates of remaining capacity and reports timely voltage, temperature, and current measurement data. Capacity estimates are calculated from a piecewise linear model of the battery performance over load and temperature along with system parameters for charge and end-of-discharge conditions. The algorithm parameters are user programmable and can be modified within the pack. Critical capacity and aging data are periodically saved to EEPROM in case of short-circuit or deep-depletion events.

The Li+ protection function ensures safe, high-performance operation. nFET protection switches are driven with a charge pump that maintains gate drive as the cell voltage decreases. The high-side topology preserves the ground path for serial communication while eliminating the parasitic charge path formed when the fuel-gauge IC is located inside the protection FETs in a low-side configuration. The thresholds for overvoltage, undervoltage, overcurrent, and short-circuit current are user programmable for customization to each cell and application.

The 32-bit-wide SHA-1 engine with 64-bit secret and 64-bit challenge words resists brute force and other attacks with financial-level HMAC security. The challenge of managing secrets in the supply chain is addressed with the compute next secret feature. The unique serial number or ROM ID can be used to assign a unique secret to each battery.

## Power Modes

The DS2775–DS2778 have two power modes: active and sleep. On initial power-up, the DS2775–DS2778 default to active mode. In active mode, the DS2775–DS2778 are fully functional with measurements and capacity estimation registers continuously updated. The protector circuit monitors battery pack, cell voltages, and battery current for safe conditions. The protection FET gate drivers are enabled when conditions are deemed safe. Also, the SHA-1 authentication function is available in active mode. When an SHA-1 computation is performed, the supply current increases to  $I_{DD2}$  for  $t_{SHA}$ . In sleep mode, the DS2775–DS2778 con-

serve power by disabling measurement and capacity estimation functions, but preserve register contents. Gate drive to the protection FETs is disabled in sleep; the SHA-1 authentication feature is not operational.

The IC enters sleep mode under two different conditions: bus low and undervoltage. An enable bit makes entry into sleep optional for each condition. Sleep mode is not entered if a charger is connected ( $V_{PLS} > V_{DD} + V_{CD}$ ) or if a charge current of  $1.6\text{mV}/R_{SNS}$  measured from SNS to  $V_{SS}$ . The DS2775–DS2778 exit sleep mode upon charger connection or a low-to-high transition on any communication line. The bus-low condition, where all communication lines are low for  $t_{SLEEP}$ , indicates pack removal or system shutdown in which the bus pullup voltage,  $V_{PULLUP}$ , is not present. The power mode (PMOD) bit must be set to enter sleep when a bus-low condition occurs. After the DS2775–DS2778 enter sleep due to a bus-low condition, it is assumed that no charge or discharge current flows and that coulomb counting is unnecessary.

The second condition to enter sleep is an undervoltage condition, which reduces battery drain due to the DS2775–DS2778 supply current and prevents overdischarging the cell. The DS2775–DS2778 transition to sleep mode if the  $V_{IN1}$  or  $V_{IN2}$  voltage is less than  $V_{UV}$  and the undervoltage enable (UVEN) bit is set. The communication bus must be in a static state, that is, with DQ (SDA and SCL for 2-wire) either high or low for  $t_{SLEEP}$ . The DS2775–DS2778 transition from sleep mode to active mode when DQ (SDA and SCL for 2-wire) changes logic state. See Figures 1 and 2 for more information on sleep-mode state.

The DS2775–DS2778 have a “power switch” capability for waking the device and enabling the protection FETs when the host system is powered down. A simple dry contact switch on the PIO pin or DQ pin can be used to wake up the battery pack. The power-switch function is enabled using the PSPIO and PSDQ configuration bits in the Control register.

When PSPIO or PSDQ are set and sleep mode is entered through the PMOD condition\*, the PIO and DQ pins pull high, respectively. Sleep mode is exited upon the detection of a low-going transition on PIO or DQ. PIO has a 100ms debounce period to filter out glitches that can be caused when a sleeping battery is inserted into a system.

\*The “power switch” feature is disabled if sleep mode is entered because of a UV condition.

## 2-Cell, Stand-Alone, Li+ Fuel-Gauge IC with Protector and Optional SHA-1 Authentication

DS2775/DS2776/DS2777/DS2778

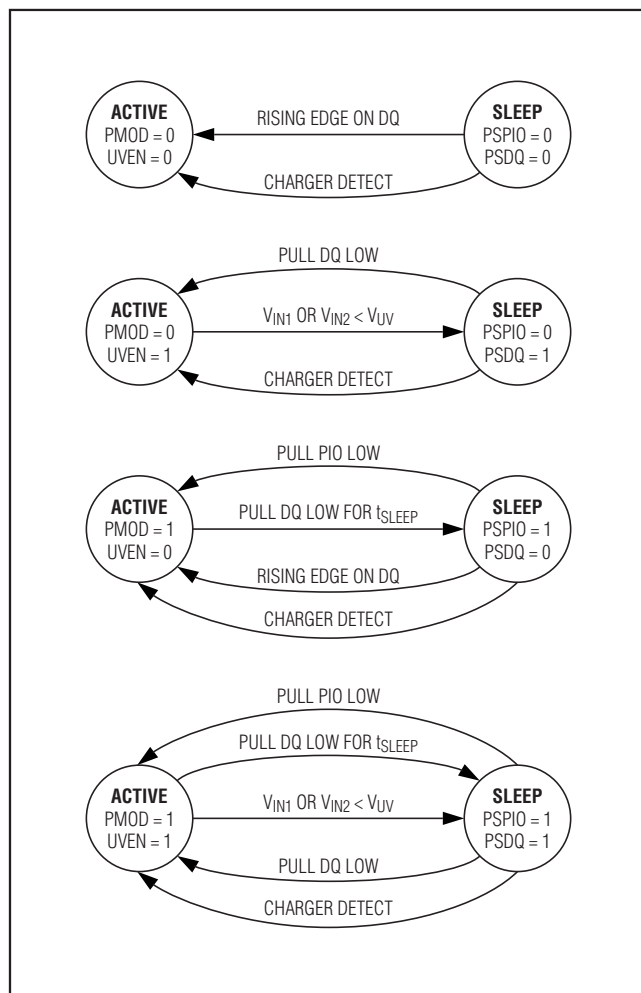

Figure 1. Sleep-Mode State Diagram for DS2775/DS2776

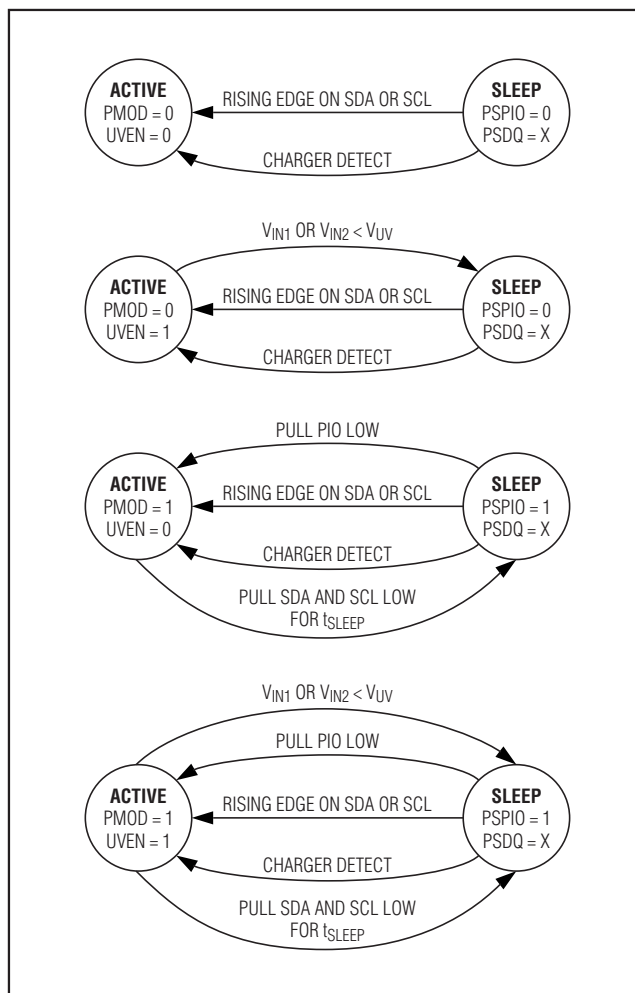

Figure 2. Sleep-Mode State Diagram for DS2777/DS2778

### Li+ Protection Circuitry

During active mode, the DS2775–DS2778 constantly monitor SNS,  $V_{IN1}$ ,  $V_{IN2}$ , and PLS to protect the battery from overvoltage (overcharge), undervoltage (overdischarge), and excessive charge and discharge currents (overcurrent, short circuit). Table 1 summarizes the conditions that activate the protection circuit, the response of the DS2775–DS2778, and the thresholds that release the DS2775–DS2778 from a protection state. Figure 3 shows Li+ protection circuitry example waveforms.

### Overvoltage (OV)

If either of the voltages on ( $V_{IN2} - V_{IN1}$ ) or ( $V_{IN1} - V_{SS}$ ) exceeds the overvoltage threshold,  $V_{OV}$ , for a period longer than overvoltage delay,  $t_{OVD}$ , the CC pin is driven low to shut off the external charge FET. The DC output remains high during overvoltage to allow discharging. When ( $V_{IN2} - V_{IN1}$ ) and ( $V_{IN1} - V_{SS}$ ) falls below the charge-enable threshold,  $V_{CE}$ , the DS2775–DS2778 turn the charge FET on by driving CC high. The DS2775–DS2778 drive CC high before  $[(V_{IN2} - V_{IN1}) \text{ and } (V_{IN1} - V_{SS})] < V_{CE}$  if a discharge condition persists with  $V_{SNS} \geq 1.2\text{mV}$  and  $[(V_{IN2} - V_{IN1}) \text{ and } (V_{IN1} - V_{SS})] < V_{OV}$ .

## 2-Cell, Stand-Alone, Li+ Fuel-Gauge IC with Protector and Optional SHA-1 Authentication

Table 1. Li+ Protection Conditions and DS2775/DS2776 Responses

CONDITION	ACTIVATION			RELEASE THRESHOLD
	THRESHOLD	DELAY	RESPONSE	
Overvoltage (OV) (Note 1)	$V_{CELL} > V_{OV}$	$t_{OVD}$	CC Off	Both $V_{CELL} < V_{CE}$ or $(V_{SNS} \geq 1.2mV$ and both $V_{CELL} < V_{OV})$ (Note 1)
Undervoltage (UV) (Note 1)	$V_{CELL} < V_{UV}$	$t_{UVD}$	CC Off, DC Off, Sleep Mode (Note 2)	$V_{PLS} > V_{IN2}$ (charger connected) or (both $V_{CELL} > V_{UV}$ and $UVEN = 0$ ) (Note 3)
Overcurrent, Charge (COC)	$V_{SNS} < V_{COC}$	$t_{OCD}$	CC Off, DC Off	$V_{PLS} < V_{DD} - V_{TP}$ (charger removed) (Note 4)
Overcurrent, Discharge (DOC)	$V_{SNS} > V_{DOC}$	$t_{OCD}$	DC Off	$V_{PLS} > V_{DD} - V_{TP}$ (load removed) (Note 5)
Short Circuit (SC)	$V_{SNS} > V_{SC}$	$t_{SCD}$	DC Off	$V_{PLS} > V_{DD} - V_{TP}$ (Note 5)

**Note 1:**  $V_{CELL}$  is defined as  $(V_{IN1} - V_{SS})$  or  $(V_{IN2} - V_{IN1})$ .

**Note 2:** Sleep mode is only entered if  $UVEN = 1$ .

**Note 3:** If  $V_{CELL} < V_{UV}$  when a charger connection is detected, release is delayed until  $V_{CELL} \geq V_{UV}$ . The recovery charge path provides an internal current limit ( $I_{RC}$ ) to safely charge the battery.

**Note 4:** With test current  $I_{PPD}$  flowing from PLS to  $V_{SS}$  (pulldown on PLS) enabled.

**Note 5:** With test current  $I_{TST}$  flowing from  $V_{DD}$  to PLS (pullup on PLS).

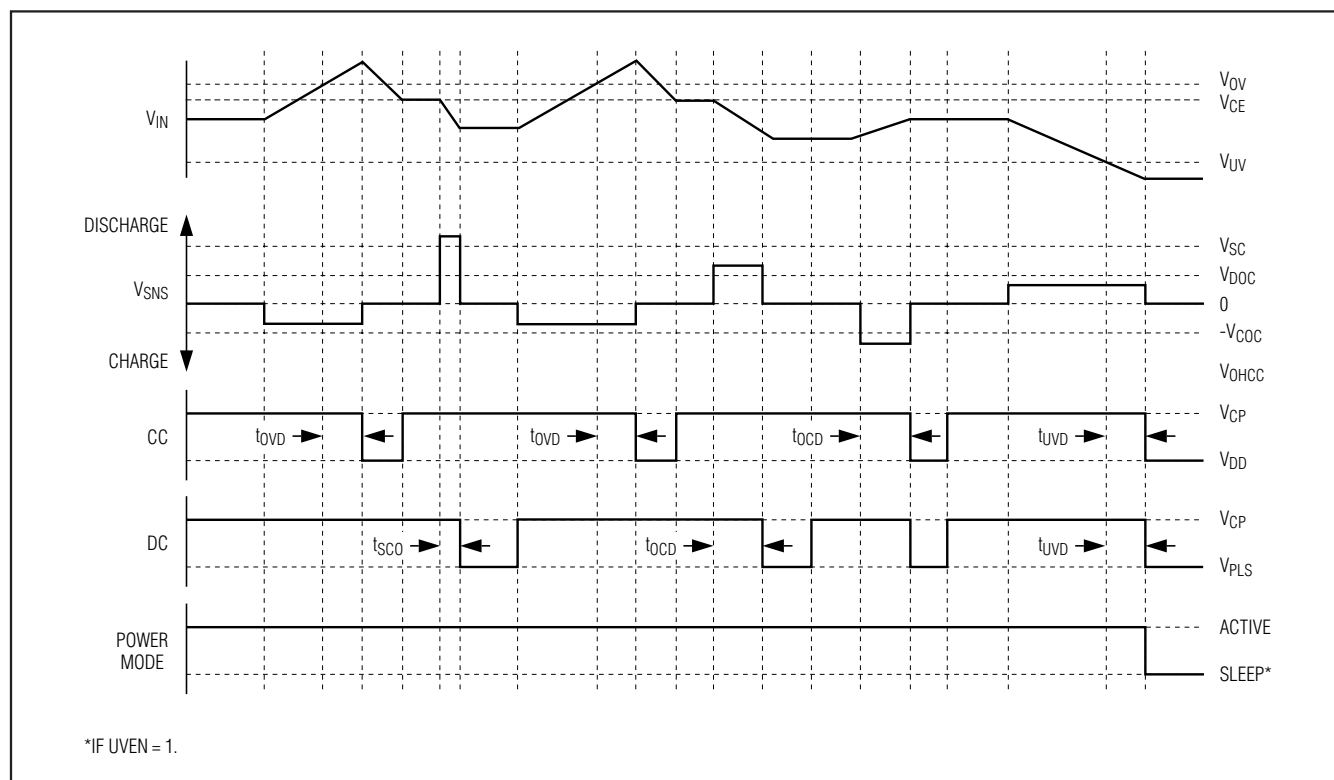

Figure 3. Li+ Protection Circuitry Example Waveforms

## 2-Cell, Stand-Alone, Li+ Fuel-Gauge IC with Protector and Optional SHA-1 Authentication

**DS2775/DS2776/DS2777/DS2778**

### Undervoltage (UV)

If the average of the voltages on ( $V_{IN2} - V_{IN1}$ ) or ( $V_{IN1} - V_{SS}$ ) drops below the undervoltage threshold,  $V_{UV}$ , for a period longer than undervoltage delay,  $t_{UVD}$ , the DS2775–DS2778 shut off the charge and discharge FETs. If UVEN is set, the DS2775–DS2778 also enter sleep mode. When a charger is detected and  $V_{PLS} > V_{IN2}$ , the DS2775–DS2778 provide a current-limited recovery charge path (IRC) from PLS to  $V_{DD}$  to gently charge severely depleted cells. The recovery charge path is enabled when  $0 \leq [(V_{IN2} - V_{IN1}) \text{ and } (V_{IN1} - V_{SS})] < V_{CE}$ . The FETs remain off until ( $V_{IN2} - V_{IN1}$ ) and ( $V_{IN1} - V_{SS}$ ) exceed  $V_{UV}$ .

### Overcurrent, Charge Direction (COC)

Charge current develops a negative voltage on  $V_{SNS}$  with respect to  $V_{SS}$ . If  $V_{SNS}$  is less than the charge overcurrent threshold,  $V_{COC}$ , for a period longer than overcurrent delay,  $t_{OCD}$ , the DS2775–DS2778 shut off both external FETs. The charge current path is not reestablished until the voltage on the PLS pin drops below ( $V_{DD} - V_{TP}$ ). The DS2775–DS2778 provide a test current of value  $I_{PPD}$  from PLS to  $V_{SS}$ , pulling PLS down, in order to detect the removal of the offending charge current source.

### Overcurrent, Discharge Direction (DOC)

Discharge current develops a positive voltage on  $V_{SNS}$  with respect to  $V_{SS}$ . If  $V_{SNS}$  exceeds the discharge overcurrent threshold,  $V_{DOC}$ , for a period longer than  $t_{OCD}$ , the DS2775–DS2778 shut off the external discharge FET. The discharge current path is not reestablished until the voltage on PLS rises above ( $V_{DD} - V_{TP}$ ).

The DS2775–DS2778 provide a test current of value  $I_{TST}$  from  $V_{DD}$  to PLS, pulling PLS up, in order to detect the removal of the offending low-impedance load.

### Short Circuit (SC)

If  $V_{SNS}$  exceeds short-circuit threshold,  $V_{SC}$ , for a period longer than short-circuit delay,  $t_{SCD}$ , the DS2775–DS2778 shut off the external discharge FET. The discharge current path is not reestablished until the voltage on PLS rises above ( $V_{DD} - V_{TP}$ ). The DS2775–DS2778 provide a test current of value  $I_{TST}$  from  $V_{DD}$  to PLS, pulling PLS up, in order to detect the removal of the short circuit.

All the protection conditions described are logic ANDed to affect the CC and DC outputs.

$CC = (\overline{\text{overvoltage}}) \text{ AND } (\overline{\text{undervoltage}}) \text{ AND } (\overline{\text{overcurrent, charge direction}}) \text{ AND } (\text{Protection register bit CE} = 0)$

$DC = (\overline{\text{undervoltage}}) \text{ AND } (\overline{\text{overcurrent, either direction}}) \text{ AND } (\overline{\text{short circuit}}) \text{ AND } (\text{Protection register bit DE} = 0)$

### Voltage Measurements

Cell voltages are measured every 440ms. The lowest potential cell,  $V_{IN1}$ , is measured with respect to  $V_{SS}$ . The highest potential cell,  $V_{IN2}$ , is measured with respect to  $V_{IN1}$ . Battery voltages are measured with a range of -5V to +4.9951V and a resolution of 4.8828mV and placed in the Result register in two's complement form. Voltages above the maximum register value are reported as 7FE0h.

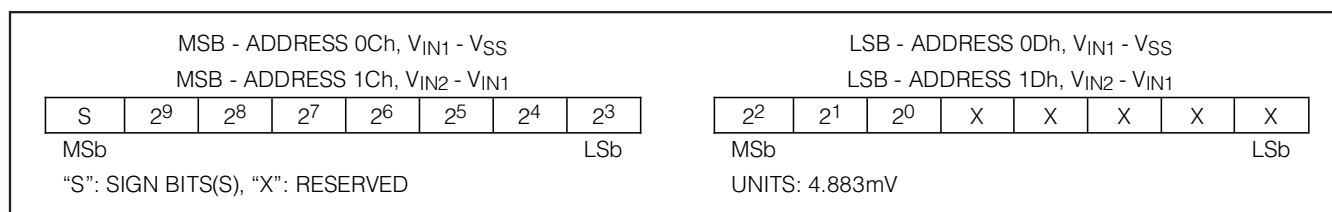

Figure 4. Voltage Register Format

## 2-Cell, Stand-Alone, Li+ Fuel-Gauge IC with Protector and Optional SHA-1 Authentication

### Temperature Measurement

The DS2775–DS2778 use an integrated temperature sensor to measure battery temperature with a resolution of 0.125°C. Temperature measurements are updated every 440ms and placed in the Temperature register in two's complement form.

### Current Measurement

In active mode, the DS2775–DS2778 continuously measure the current flow into and out of the battery by measuring the voltage drop across a low-value current-sense resistor,  $R_{SNS}$ . The voltage-sense range between SNS and  $V_{SS}$  is  $\pm 51.2\text{mV}$  with a least significant bit (LSb) of

1.5625 $\mu\text{V}$ . The input linearly converts peak signal amplitudes up to 102.4mV as long as the continuous signal level (average over the conversion cycle period) does not exceed  $\pm 51.2\text{mV}$ . The ADC samples the input differentially at 18.6kHz and updates the Current register at the completion of each conversion cycle (3.52s). Charge currents above the maximum register value are reported as 7FFFh. Discharge currents below the minimum register value are reported as 8000h.

The Average Current register reports an average current level over the preceding 28.16s. The register value is updated every 28.16s in two's complement form and represents an average of the eight preceding Current register values.

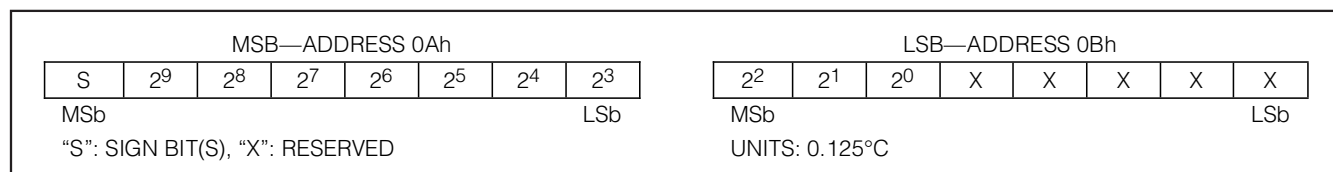

Figure 5. Temperature Register Format

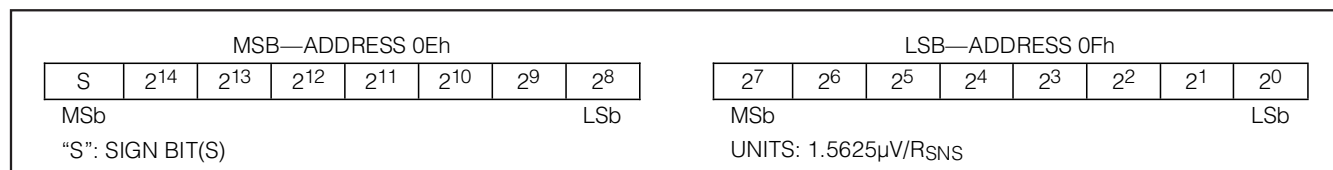

Figure 6. Current Register Format

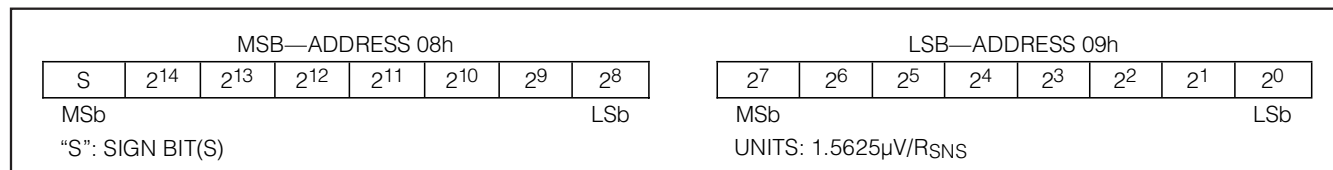

Figure 7. Average Current Register Format

## 2-Cell, Stand-Alone, Li+ Fuel-Gauge IC with Protector and Optional SHA-1 Authentication

DS2775/DS2776/DS2777/DS2778

### Current Offset Correction

Every 1024th conversion, the ADC measures its input offset to facilitate offset correction. Offset correction occurs approximately once per hour. The resulting correction factor is applied to the subsequent 1023 measurements. During the offset correction conversion, the ADC does not measure the sense resistor signal. A maximum error of 1/1024 in the Accumulated Current register (ACR) is possible; however, to reduce the error, the current measurement made just prior to the offset conversion is retained in the Current register and is substituted for the dropped current measurement in the current accumulation process. Therefore the accumulated current error due to offset correction is typically much less than 1/1024.

### Current Offset Bias

The current offset bias value (COB) allows a programmable offset value to be added to raw current measurements. The result of the raw current measurement plus COB is displayed as the current measurement result in the Current register and is used for current accumulation. COB can be used to correct for a static offset error or can be used to intentionally skew the current results and therefore the current accumulation. Read and write access is allowed to COB. Whenever the COB is written, the new value is applied to all subsequent current measurements. COB can be programmed in 1.56 $\mu$ V steps to any value between -199.7 $\mu$ V and +198.1 $\mu$ V. The COBR value is stored as a two's complement value in volatile memory and must be initialized through the interface on power-up. The factory default value is 00h.

### Current Blanking

The current blanking feature modifies current measurement result prior to being accumulated in the ACR. Current blanking occurs conditionally when a current measurement (raw current and COBR) falls in one of two defined ranges. The first range prevents charge currents less than 100 $\mu$ V from being accumulated. The second range prevents discharge currents less than 25 $\mu$ V in magnitude from being accumulated. Charge current blanking is always performed; however, discharge current blanking must be enabled by setting the NBEN bit in the Control register. See the *Control Register Format* description for additional information.

### Current Measurement Gain

The DS2775–DS2778's current measurement gain can be adjusted through the RSGAIN register, which is factory calibrated to meet the data sheet specified accuracy. RSGAIN is user accessible and can be reprogrammed after module or pack manufacture to improve the current measurement accuracy. Adjusting RSGAIN can correct for variation in an external sense resistor's nominal value and allows the use of low-cost, nonprecision current-sense resistors. RSGAIN is an 11-bit value stored in 2 bytes of the parameter EEPROM memory block. The RSGAIN value adjusts the gain from 0 to 1.999 in steps of 0.001 (precisely 2<sup>-10</sup>). The user must use caution when programming RSGAIN to ensure accurate current measurement. When shipped from the factory, the gain calibration value is stored in two separate locations in the parameter EEPROM block, RSGAIN, which is reprogrammable and FRSGAIN, which is read-only. RSGAIN determines the gain used in the current measurement. The

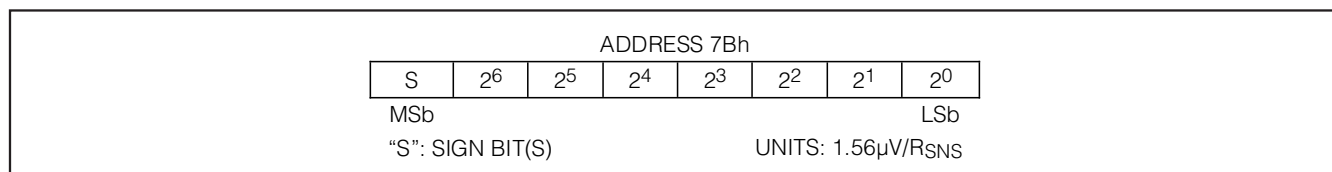

Figure 8. Current Offset Bias Register Format

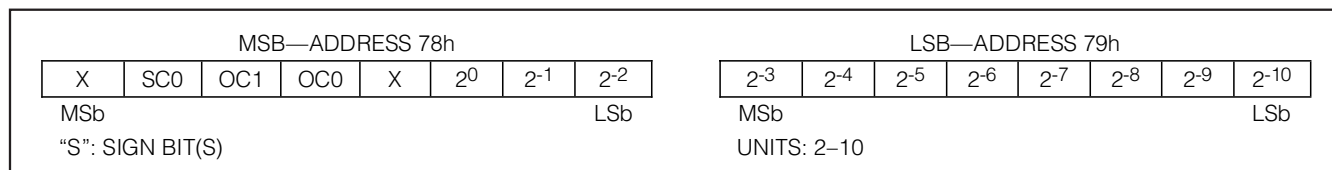

Figure 9. RSGAIN Register



## 2-Cell, Stand-Alone, Li+ Fuel-Gauge IC with Protector and Optional SHA-1 Authentication

FRSGAIN value is provided to preserve the factory calibration value only and is not used to calibrate the current measurement. The 16-bit FRSGAIN value is readable from addresses B0h and B1h.

### Sense-Resistor Temperature Compensation

The DS2775–DS2778 can temperature compensate the current-sense resistor to correct for variation in a sense resistor's value over temperature. The DS2775–DS2778 are factory programmed with the sense-resistor temperature coefficient, RSTC, set to zero, which turns off the temperature compensation function. RSTC is user accessible and can be reprogrammed after module or pack manufacture to improve the current accuracy when using a high-temperature coefficient current-sense resistor. RSTC is an 8-bit value stored in the parameter EEPROM memory block. The RSTC value sets the temperature coefficient from 0 to +7782ppm/°C in steps of 30.5ppm/°C. The user must program RSTC cautiously to ensure accurate current measurement.

Temperature compensation adjustments are made when the Temperature register crosses 0.5°C boundaries. The temperature compensation is most effective with the resistor placed as close as possible to the V<sub>SS</sub> terminal to optimize thermal coupling of the resistor to the on-chip temperature sensor. If the current shunt is constructed with a copper PCB trace, run the trace under the DS2775–DS2778 package whenever possible.

### Current Accumulation

Current measurements are internally summed, or accumulated, at the completion of each conversion period

with the results displayed in the Accumulated Current register (ACR). The accuracy of the ACR is dependent on both the current measurement and the conversion time base. The ACR has a range of 0 to +409.6mVh with an LSb of 6.25μVh. Additional registers hold fractional results of each accumulation to avoid truncation errors. The fractional result bits are not user accessible. Accumulation of charge current above the maximum register value is reported at the maximum value; conversely, accumulation of discharge current below the minimum register value is reported at the minimum value.

Charge currents (positive Current register values) less than 100μV are not accumulated in order to mask the effect of accumulating small positive offset errors over long periods. This effect limits the minimum charge current, for coulomb counting purposes, to 5mA for R<sub>SNS</sub> = 0.020Ω and 20mA for R<sub>SNS</sub> = 0.005Ω (see Table 2 for more details).

Read and write access is allowed to the ACR. The ACR must be written most significant byte (MSB) first, then LSB. Whenever the ACR is written, the fractional accumulation result bits are cleared. The write must be completed in 3.5s. A write to the ACR forces the ADC to perform an offset correction conversion and update the internal offset correction factor. The current measurement and accumulation begin with the second conversion following a write to the ACR. To preserve the ACR value in case of power loss, the ACR value is backed up to EEPROM. The ACR value is recovered from EEPROM on power-up. See the *Memory Map* for specific address location and back-up frequency.

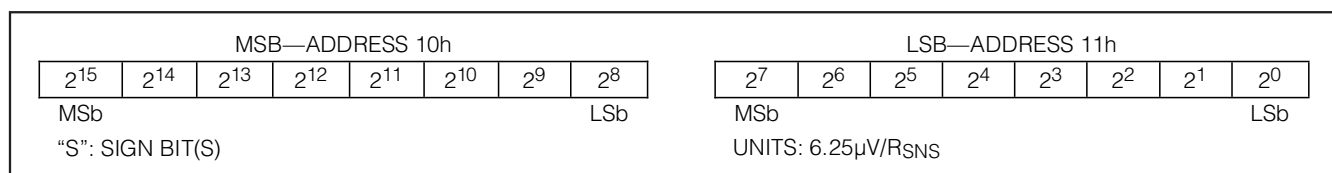

Figure 10. Accumulated Current Register Format

Table 2. Resolution and Range vs. Sense Resistor

TYPE OF RESOLUTION/RANGE	V <sub>SS</sub> - V <sub>SNS</sub>	R <sub>SNS</sub>			
		20mΩ	15mΩ	10mΩ	5mΩ
Current Resolution	1.5625μV	78.13μA	104.2μA	156.3μA	312.5μA
Current Range	±51.2mV	±2.56A	±3.41A	±5.12A	±10.2A
ACR Resolution	6.25μVh	312.5μAh	416.7μAh	625μAh	1.250mAh
ACR Range	±409.6mVh	±20.48Ah	±27.30Ah	±40.96Ah	±81.92Ah

DS2775/DS2776/DS2777/DS2778

## 2-Cell, Stand-Alone, Li+ Fuel-Gauge IC with Protector and Optional SHA-1 Authentication

DS2775/DS2776/DS2777/DS2778

### Accumulation Bias

In some designs a systematic error or an application preference requires the application of an arbitrary bias to the current accumulation process. The Current Accumulation Bias register (CAB) allows a user-programmed constant positive or negative polarity bias to be included in the current accumulation process. The value in CAB can be used to estimate battery currents that do not flow through the sense resistor, estimate battery self-discharge, or estimate current levels below the current measurement resolution. The user-programmed two's complement value, with bit weighting the same as the current register, is added to the ACR once per current conversion cycle. CAB is loaded on power-up from EEPROM memory.

### Cycle Counter

The cycle counter is an absolute count of the cumulative discharge cycles. This register is intended to act as a "cell odometer." The LSb is two cycles, which allows a maximum count of 510 discharge cycles. The register does not loop. Once the maximum value is reached, the register is clamped. This register is read and write accessible while the parameter EEPROM memory block (block 1) is unlocked. The Cycle Count register becomes read-only once the EEPROM block is locked.

### Capacity Estimation Algorithm

Remaining capacity estimation uses real-time measured values and stored parameters describing the cell characteristics and application operating limits. Figure 13 describes the algorithm inputs and outputs.

### Modeling Cell Characteristics

To achieve reasonable accuracy in estimating remaining capacity, the cell performance characteristics over temperature, load current, and charge-termination point must be considered. Since the behavior of Li+ cells is nonlinear, these characteristics must be included in the capacity estimation to achieve an acceptable level of accuracy in the capacity estimation. The FuelPack method used in the DS2775–DS2778 is described in general in Application Note 131: *Lithium-Ion Cell Fuel Gauging with Maxim Battery Monitor ICs*. To facilitate efficient implementation in hardware, a modified version of the method outlined in Application Note 131 is used to store cell characteristics in the DS2775–DS2778. Full and empty points are retrieved in a lookup process that retraces a piecewise linear model consisting of three model curves named full, active empty, and standby empty. Each model curve is constructed with five line segments, numbered 1 through 5. Above +40°C, the segment 5 model curves extend infinitely with zero slope, approximating the nearly flat change in capacity of Li+ cells at temperatures above +40°C. Segment 4 of each model curves originates at +40°C on its upper end and extends downward in temperature to the junction with segment 3. Segment 3 joins with segment 2, which in turn joins with segment 1. Segment 1 of each model curve extends from the junction with segment 2 to infinitely colder temperatures. The three junctions or break-points that join the segments (labeled TBP12, TBP23, and TBP34 in Figure 14) are programmable in 1°C increments from -128°C to +40°C. The slope or derivative for segments 1, 2, 3, and 4 are also programmable over a range of 0 to 15,555ppm in steps of 61ppm.

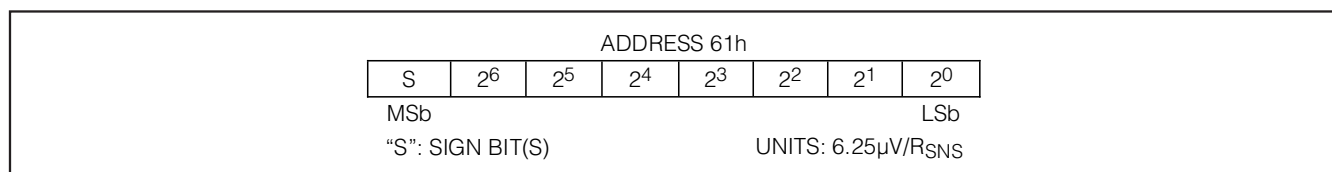

Figure 11. Current Accumulation Bias Register Format

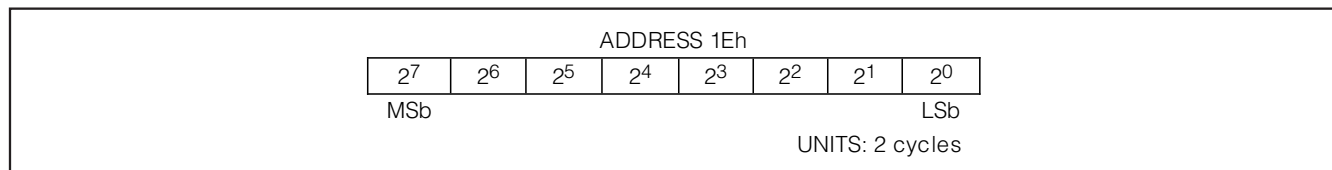

Figure 12. Cycle Counter Register Format

## 2-Cell, Stand-Alone, Li+ Fuel-Gauge IC with Protector and Optional SHA-1 Authentication

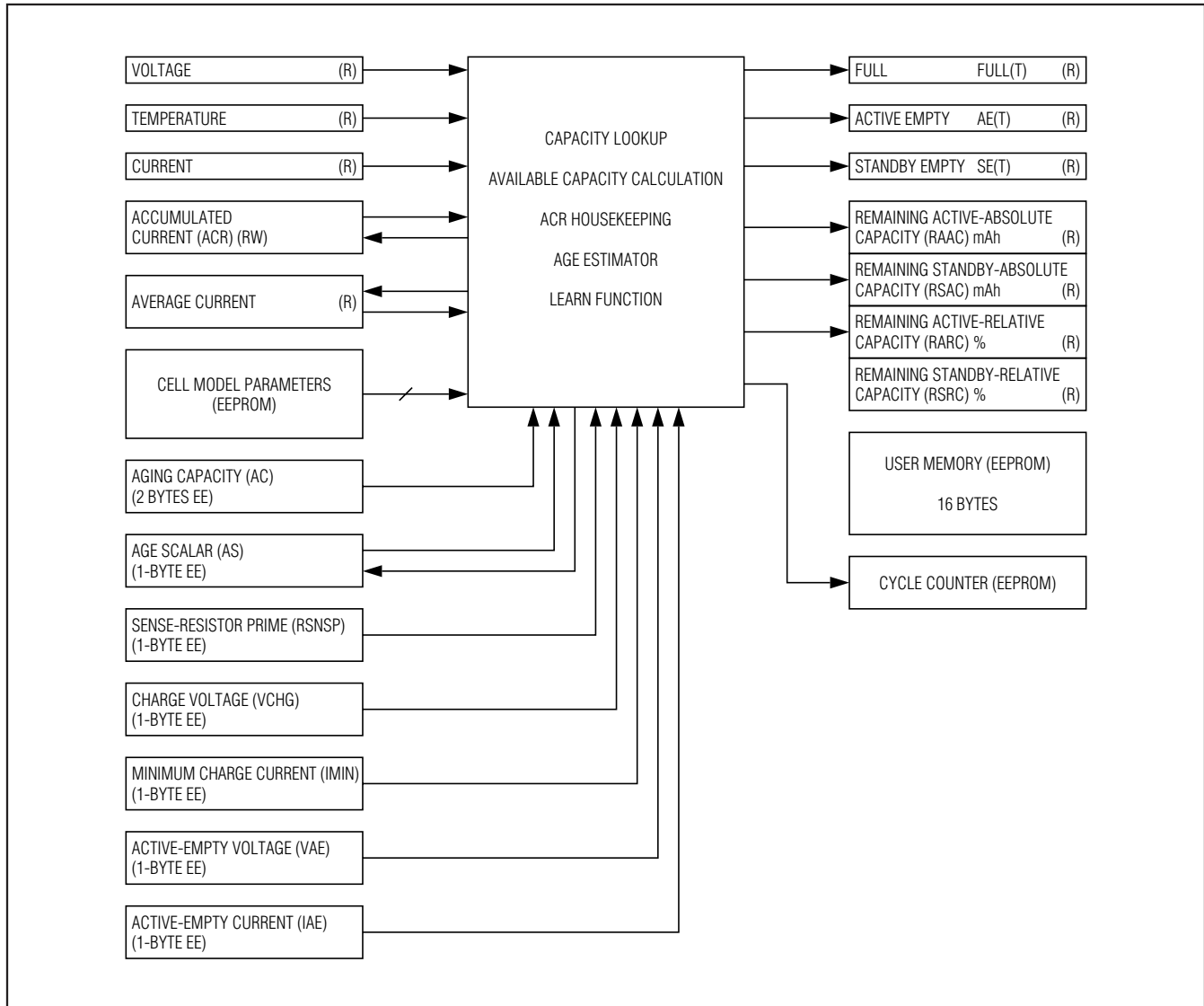

Figure 13. Top-Level Algorithm Diagram

### Full

The full curve defines how the full point of a given cell depends on temperature for a given charge termination. The application's charge termination method should be used to determine the table values. The DS2775–DS2778 reconstruct the full line from cell characteristic table values to determine the full capacity of the battery at each temperature. Reconstruction occurs in one-degree temperature increments.

### Active Empty

The active-empty curve defines the variation of the active-empty point over temperature. The active-empty point is defined as the minimum voltage required for system operation at a discharge rate based on a high-level load current (one that is sustained during a high-power operating mode). This load current is programmed as the active-empty current (IAE), and should be a 3.5s average value to correspond to values

DS2775/DS2776/DS2777/DS2778

## 2-Cell, Stand-Alone, Li+ Fuel-Gauge IC with Protector and Optional SHA-1 Authentication

DS2775/DS2776/DS2777/DS2778

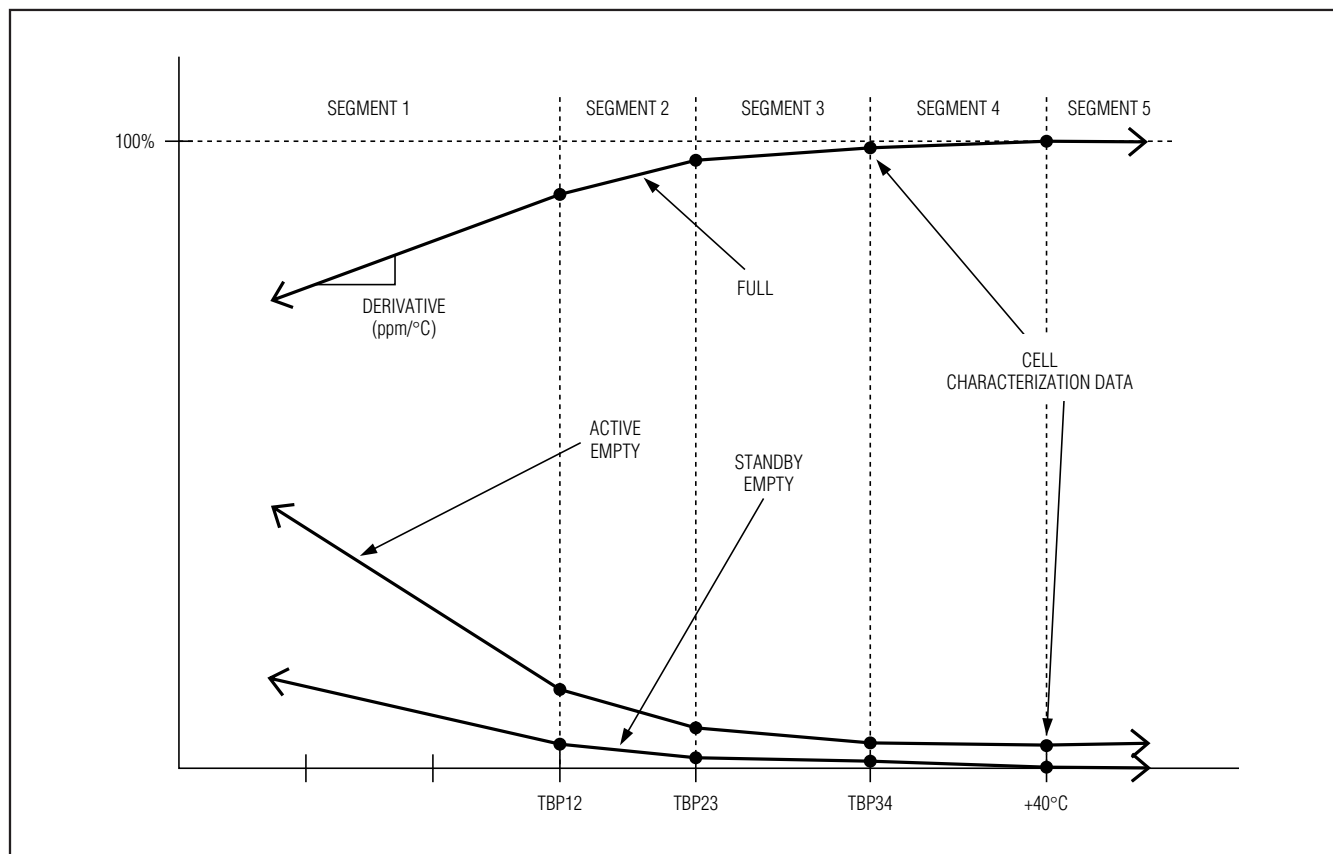

Figure 14. Cell Model Example Diagram

read from the Current register. The specified minimum voltage, or active-empty voltage (VAE), should be a 110ms average value to correspond to the values read from the voltage register. The VAE value represents the average of the two cell's voltages,  $V_{IN1}$  and  $V_{IN2}$ . The DS2775–DS2778 reconstruct the active-empty line from the cell characteristic table to determine the active-empty capacity of the battery at each temperature. Reconstruction occurs in one-degree temperature increments.

### Standby Empty

The standby-empty curve defines the variation of the standby-empty point over temperature. The standby-empty point is defined as the minimum voltage required for standby operation at a discharge rate dictated by the application standby current. In typical handheld applications, standby empty represents the point that the battery can no longer support DRAM refresh and

thus the standby voltage is set by the minimum DRAM voltage-supply requirements. In other applications, standby empty can represent the point that the battery can no longer support a subset of the full application operation, such as games or organizer functions. The standby-load current and voltage are used for determining the cell characteristics but are not programmed into the DS2775–DS2778. The DS2775–DS2778 reconstruct the standby-empty line from the cell characteristic table to determine the standby-empty capacity of the battery at each temperature. Reconstruction occurs in one-degree temperature increments.

### Cell Model Construction

The model is constructed with all points normalized to the fully charged state at +40°C. All values are stored in the cell parameter EEPROM block. The +40°C full value is stored in  $\mu\text{Vh}$  with an LSB of  $6.25\mu\text{Vh}$ . The +40°C active-empty value is stored as a percentage of +40°C

## 2-Cell, Stand-Alone, Li+ Fuel-Gauge IC with Protector and Optional SHA-1 Authentication

full with a resolution of  $2^{-10}$ . Standby empty at  $+40^{\circ}\text{C}$  is, by definition, zero and therefore no storage is required. The slopes (derivatives) of the four segments for each model curve are stored in the cell parameter EEPROM block as  $\text{ppm}/^{\circ}\text{C}$ . The breakpoint temperatures of each segment are stored there also (refer to Application Note 3584: *Storing Battery Fuel Gauge Parameters in DS2780* for more details on how values are stored). An example of data stored in this manner is shown in Table 3.

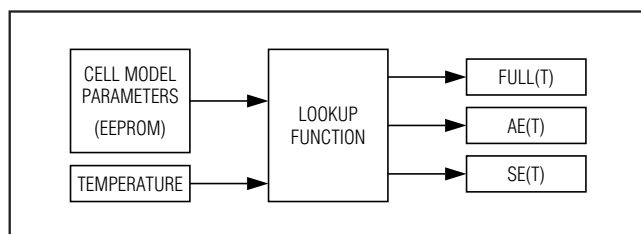

Figure 15. Lookup Function Diagram

### Application Parameters

In addition to cell model characteristics, several application parameters are needed to detect the full and empty points, as well as calculate results in mAh units.

#### Sense Resistor Prime (RSNSP)

RSNSP stores the value of the sense resistor for use in computing the absolute capacity results. The value is stored as a 1-byte conductance value with units of mhos ( $1/\Omega$ ). RSNSP supports resistor values of  $1\Omega$  to  $3.922\text{m}\Omega$ . RSNSP is located in the parameter EEPROM block.

$$\text{RSNSP} = 1/\text{RSNS} \text{ (units of mhos; } 1/\Omega\text{)}$$

#### Charge Voltage (VCHG)

VCHG stores the charge voltage threshold used to detect a fully charged state. The voltage is stored as a 1-byte value with units of  $19.5\text{mV}$  and can range from 0 to  $4.978\text{V}$ . VCHG should be set marginally less than the average cell voltage at the end of the charge cycle to ensure reliable charge termination detection. VCHG is located in the parameter EEPROM block.

Table 3. Example Cell Characterization Table (Normalized to  $+40^{\circ}\text{C}$ )

<b>Manufacturer's Rated Cell Capacity: 1000mAh</b>	
<b>Charge Voltage: 4.2V</b>	<b>Termination Current: 50mA</b>
<b>Active Empty (V): 3.0V</b>	<b>Standby Empty (I): 300mA</b>
<b>Sense Resistor: 0.020<math>\Omega</math></b>	

SEGMENT BREAKPOINTS
TBP12 = $-12^{\circ}\text{C}$
TBP23 = $0^{\circ}\text{C}$
TBP34 = $18^{\circ}\text{C}$

CALCULATED VALUE	$+40^{\circ}\text{C}$ NOMINAL (mAh)	SEGMENT 1 ( $\text{ppm}/^{\circ}\text{C}$ )	SEGMENT 2 ( $\text{ppm}/^{\circ}\text{C}$ )	SEGMENT 3 ( $\text{ppm}/^{\circ}\text{C}$ )	SEGMENT 4 ( $\text{ppm}/^{\circ}\text{C}$ )
Full	1051	3601	3113	1163	854
Active Empty		2380	1099	671	305
Standby Empty		1404	427	244	183

## 2-Cell, Stand-Alone, Li+ Fuel-Gauge IC with Protector and Optional SHA-1 Authentication

DS2775/DS2776/DS2777/DS2778

### Minimum Charge Current (IMIN)

IMIN stores the charge-current threshold used to detect a fully charged state. It is stored as a 1-byte value with units of  $50\mu\text{V}$  ( $\text{IMIN} \times R_{\text{SNS}}$ ) and can range from 0 to 12.75mV. Assuming  $R_{\text{SNS}} = 20\text{m}\Omega$ , IMIN can be programmed from 0 to 637.5mA in 2.5mA steps. IMIN should be set marginally greater than the charge current at the end of the charge cycle to ensure reliable charge termination detection. IMIN is located in the parameter EEPROM block.

### Active-Empty Voltage (VAE)

VAE stores the voltage threshold used to detect the active-empty point. The value is stored in 1 byte with units of 19.5mV and can range from 0 to 4.978V. VAE is stored as an average of the cell's voltages. VAE is located in the parameter EEPROM block. See the *Modeling Cell Characteristics* section for more information.

### Active-Empty Current (IAE)

IAE stores the discharge-current threshold used to detect the active-empty point. The unsigned value represents the magnitude of the discharge current and is stored in 1 byte with units of  $200\mu\text{V}$  and can range from 0 to 51.2mV. Assuming  $R_{\text{SNS}} = 20\text{m}\Omega$ , IAE can be programmed from 0 to 2550mA in 10mA steps. IAE is located in the parameter EEPROM block. See the *Modeling Cell Characteristics* section for more information.

### Aging Capacity (AC)

AC stores the rated cell capacity, which is used to estimate the decrease in battery capacity that occurs during normal use. The value is stored in 2 bytes in the same units as the ACR (6.25 $\mu\text{Vh}$ ). When set to the manufacturer's rated cell capacity, the aging estimation rate is approximately 2.4% per 100 cycles of equivalent full capacity discharges. Partial discharge cycles are added to form equivalent full capacity discharges. The default aging estimation results in 88% capacity after 500 equivalent cycles. The aging estimation rate can be adjusted by setting the AC to a value other than the cell manufacturer's rating. Setting AC to a lower value accelerates the aging estimation rate. Setting AC to a higher value retards the aging estimation rate. The AC is located in the parameter EEPROM block.

### Age Scalar (AS)

AS adjusts the cell capacity estimation results downward to compensate for aging. The AS is a 1-byte value that has a range of 49.2% to 100%. The LSB is weighted at 0.78% (precisely  $2^{-7}$ ). A value of 100% (128 decimal or 80h) represents an unaged battery. A value of 95% is recommended as the starting AS value at the

time of pack manufacture to allow the learning of a larger capacity on batteries that have an initial capacity greater than the rated cell capacity programmed in the cell characteristic table. The AS is modified by aging estimation introduced under aging capacity and by the learn function.

Batteries are typically considered worn out when the full capacity reaches 80% of the rated capacity; therefore, the AS value is not required to range to 0%. It is clamped to 50% (64 decimal or 40h). If a value of 50% is read from the AS, the host should prompt the user to initiate a learning cycle.

The host system has read and write access to the AS; however, caution should be exercised when writing it to ensure that the cumulative aging estimate is not overwritten with an incorrect value. The AS is automatically saved to EEPROM. The EEPROM value is recalled on power-up.

## Capacity Estimation Operation

### Cycle-Count-Based Aging Estimation

As previously discussed, the AS register value is adjusted occasionally based on cumulative discharge. As the ACR register decrements during each discharge cycle, an internal counter is incremented until equal to 32 times the AC. The AS is then decremented by one, resulting in a decrease of the scaled full battery capacity by 0.78% (approximately 2.4% per 100 cycles). The internal counter is reset in the event of a learn cycle. See the *Aging Capacity (AC)* section for recommendations on customizing the age estimation rate.

### Learn Function

Because Li+ cells exhibit charge efficiencies near unity, the charge delivered to a Li+ cell from a known empty point to a known full point is a dependable measure of the cell's capacity. A continuous charge from empty to full results in a learn cycle. First, the active-empty point must be detected. The learn flag (LEARNF) is set at this point. Then, once charging starts, the charge must continue uninterrupted until the battery is charged to full. Upon detecting full, the LEARNF is cleared, the charge-to-full (CHGTF) flag is set, and the AS is adjusted according to the learned capacity of the cell.

Full capacity estimation based on the learn function is more accurate than the cycle-count-based estimation introduced under aging capacity. The learn function reflects the current performance of the cell. Cycle-count-based estimation is an approximation derived from the manufacturer's recommendation for a typical cell. Therefore, the internal counter used for cycle-

## 2-Cell, Stand-Alone, Li+ Fuel-Gauge IC with Protector and Optional SHA-1 Authentication

count-based estimation is reset after a learn cycle. The cycle-count-based estimation is used only in the absence of a learn cycle.

### ACR Housekeeping

The ACR value is adjusted occasionally to maintain the coulomb count within the model curve boundaries. When the battery is charged to full (CHGTF set), the ACR is set equal to the age-scaled full lookup value at the present temperature. If a learn cycle is in progress, correction of the ACR value occurs after the AS is updated. When an empty condition is detected (LEARNF and/or AEF set), the ACR adjustment is conditional:

- If the AEF is set and the LEARNF is not set, the active-empty point was not detected. The battery is likely below the active-empty capacity of the model. The ACR is set to the active-empty model value at present temperature only if it is greater than the active-empty model value at present temperature.
- If the AEF is set, the LEARNF is not set, and the ACR is below the active-empty model value at present temperature, the ACR is not updated.
- If the LEARNF is set, the battery is at the active-empty point and the ACR is set to the active-empty model value.

### Full Detect

Full detection occurs when the average of  $V_{IN1}$  and  $V_{IN2}$  voltage registers remain continuously above the charge voltage (VCHG) threshold for the duration of two average current (IAVG) readings, and both IAVG readings are below terminating current (IMIN). The two consecutive IAVG readings must also be positive and nonzero (>16 LSB). This ensures that removing the battery from the charger does not result in a false detection of full. Full detect sets the charge to full (CHGTF) bit in the Status register.

### Active-Empty Point Detect

Active-empty point detection occurs when the average of  $V_{IN1}$  and  $V_{IN2}$  voltage registers drops below the VAE threshold and the two previous current readings are above IAE. This captures the event of the battery reaching the active-empty point. Note that the two previous current readings must be negative and greater in magnitude than IAE (i.e., a larger discharge current than specified by the IAE threshold). Qualifying the voltage

level with the discharge rate ensures that the active-empty point is not detected at loads much lighter than those used to construct the model. Also, the active-empty point must not be detected when a deep discharge at a very light load is followed by a load greater than IAE. Either case would cause a learn cycle on the following charge to include part of the standby capacity in the measurement of the active capacity. Active-empty point detection sets the learn flag (LEARNF) bit in the Status register.

**Note:** Do not confuse the active-empty point with the active-empty flag. The active-empty flag is set only when the VAE threshold is passed.

### Result Registers

The DS2775–DS2778 process measurement and cell characteristics on a 3.5s interval and yield seven result registers. The result registers are sufficient for direct display to the user in most applications. The host system can produce customized values for system use or user display by combining measurement, result, and user EEPROM values.

#### FULL(T)

The full capacity of the battery at the present temperature is reported normalized to the +40°C full value. This 15-bit value reflects the cell model full value at the given temperature. The FULL(T) register reports values between 100% and 50% with a resolution of 61ppm (precisely  $2^{-14}$ ). Though the register format permits values greater than 100%, the register value is clamped to a maximum value of 100%.

#### Active Empty, AE(T)

The active-empty capacity of the battery at the present temperature is reported normalized to the +40°C full value. This 13-bit value reflects the cell model active-empty value at the given temperature. The AE(T) register reports values between 0% and 49.8% with a resolution of 61ppm (precisely  $2^{-14}$ ).

#### Standby Empty, SE(T)

The standby-empty capacity of the battery at the present temperature is reported normalized to the +40°C full value. This 13-bit value reflects the cell model standby-empty value at the current temperature. The SE(T) register reports values between 0% and 49.8% with a resolution of 61ppm (precisely  $2^{-14}$ ).

DS2775/DS2776/DS2777/DS2778

## 2-Cell, Stand-Alone, Li+ Fuel-Gauge IC with Protector and Optional SHA-1 Authentication

DS2775/DS2776/DS2777/DS2778

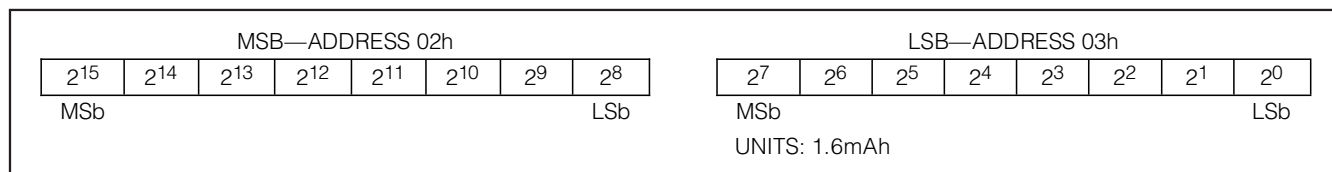

Figure 16. Remaining Active Absolute Capacity (RAAC) [mAh]

The RAAC register reports the capacity available under the current temperature conditions to the the active-empty point in absolute units of milliamps/hour (mAh). RAAC is 16 bits.

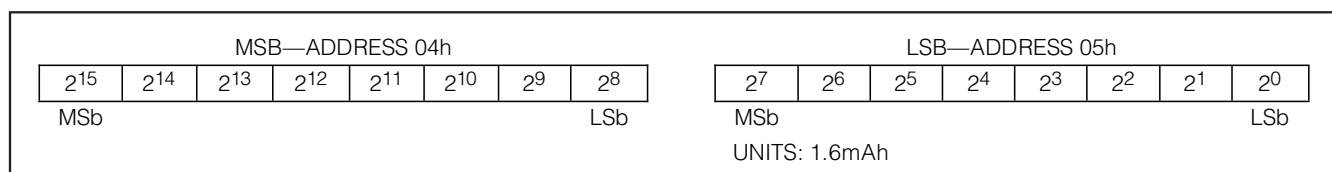

Figure 17. Remaining Standby Absolute Capacity (RSAC) [mAh]

The RSAC register reports the remaining battery capacity available under the current temperature conditions to the standby-empty point capacity in absolute units of milliamps/hour (mAh). RSAC is 16 bits.

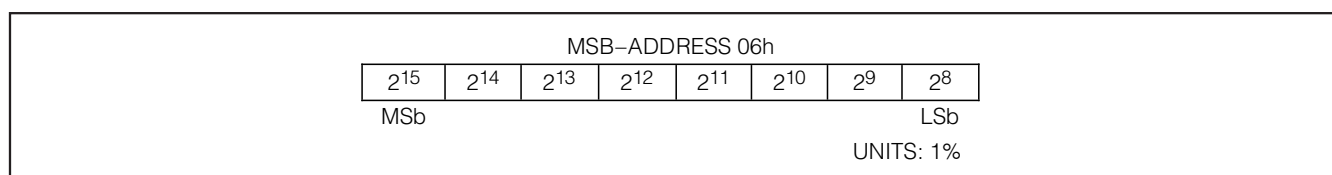

Figure 18. Remaining Active Relative Capacity (RARC) [%]

The RARC register reports the remaining battery capacity available under the current temperature conditions to the active-empty point in relative units of percent (%). RARC is 8 bits.

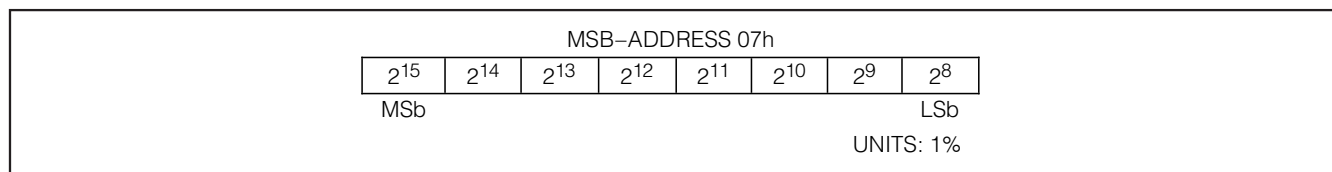

Figure 19. Remaining Standby Relative Capacity (RSRC) [%]

The RSRC register reports the remaining battery capacity available under the current temperature conditions to the standby-empty point capacity in relative units of percent (%). RSRC is 8 bits.

### Calculation of Results

$$\text{RAAC [mAh]} = (\text{ACR[mVh]} - \text{AE(T)} \times \text{FULL40[mVh]}) \times \text{RSNSP [mhos]}^*$$

$$\text{RSAC [mAh]} = (\text{ACR[mVh]} - \text{SE(T)} \times \text{FULL40[mVh]}) \times \text{RSNSP [mhos]}^*$$

$$\text{RARC [%]} = 100\% \times (\text{ACR[mVh]} - \text{AE(T)} \times \text{FULL40[mVh]}) / ((\text{AS} \times \text{FULL(T)} - \text{AE(T)}) \times \text{FULL40[mVh]})$$

$$\text{RSRC [%]} = 100\% \times (\text{ACR[mVh]} - \text{SE(T)} \times \text{FULL40[mVh]}) / ((\text{AS} \times \text{FULL(T)} - \text{SE(T)}) \times \text{FULL40[mVh]})$$

$$^* \text{RSNSP} = 1/\text{RSNS}$$



# 2-Cell, Stand-Alone, Li+ Fuel-Gauge IC with Protector and Optional SHA-1 Authentication

## Protection, Status, and Control Registers

### Protection Register Format

The Protection register reports events detected by the Li+ safety circuit on bits [7:2]. Bits 0 and 1 are used to disable the charge and discharge FET gate drivers. Bits [7:2] are set by internal hardware only. Bits 2 and 3 are cleared by hardware only. Bits [7:4] are cleared by writing the register with a 0 in the bit position of interest. Writing a 1 to bits [7:4] has no effect on the register. Bits 0 and 1 are set on power-up and a transition from sleep to active modes. While in active mode, these bits can be cleared to disable the FET gate drive of either or both FETs. Setting these bits only turns on the FETs if there are no protection faults.

### Protection Register (00h)

BIT 7	BIT 6	BIT 5	BIT 4	BIT 3	BIT 2	BIT 1	BIT 0
X	X	X	X	CC	DC	CE	DE

**Bits 7 to 4: Reserved.**

**Bit 3: Charge Control Flag (CC).** CC indicates the logic state of the CC pin driver. The CC flag is set to indicate CC high and is cleared to indicate CC low. The CC flag is read-only.

**Bit 2: Discharge Control Flag (DC).** DC indicates the logic state of the DC pin driver. DC flag is set to indicate DC high and is cleared to indicate DC low. DC flag is read-only.

**Bit 1: Charge-Enable Bit (CE).** CE must be set to allow the CC pin to drive the charge FET to the on state. CE acts as an enable input to the safety circuit. If all safety conditions are met and CE is set, the CC pin drives to  $V_{CP}$ . If CE is cleared, the CC pin is driven low to disable the charge FET. The power-up default state of CE is 1.

**Bit 0: Discharge-Enable Bit (DE).** DE must be set to allow the DC pin to drive the discharge FET to the on state. DE acts as an enable input to the safety circuit. If all safety conditions are met and DE is set, the DC pin drives to  $V_{CP}$ . If DE is cleared, the DC pin is driven low to disable the discharge FET. The power-up default state of DE is 1.

DS2775/DS2776/DS2777/DS2778

## 2-Cell, Stand-Alone, Li+ Fuel-Gauge IC with Protector and Optional SHA-1 Authentication

### Status Register Format

The Status register contains bits that report the device status. All bits are set internally. The CHGTF, AEF, SEF, and LEARNF bits are read-only.

#### Status Register (01h)

BIT 7	BIT 6	BIT 5	BIT 4	BIT 3	BIT 2	BIT 1	BIT 0
CHGTF	AEF	SEF	LEARNF	X	X	X	X

**Bit 7: Charge-Termination Flag (CHGTF).** CHGTF is set to indicate that the average of the voltages on  $V_{IN1}$  and  $V_{IN2}$  and the Average Current register values have persisted above the VCHG and below the IMIN thresholds sufficiently long enough to detect a fully charged condition. CHGTF is cleared when RARC is less than 90%. CHGTF is read-only.

**Bit 6: Active-Empty Flag (AEF).** AEF is set to indicate that the battery is at or below the active-empty point. AEF is set when the average of the voltages on  $V_{IN1}$  and  $V_{IN2}$  is less than the VAE threshold. AEF is cleared when RARC is greater than 5%. AEF is read-only.

**Bit 5: Standby-Empty Flag (SEF).** SEF is set to indicate RSRC is less than 10%. SEF is cleared when RSRC is greater than 15%. SEF is read-only.

**Bit 4: Learn Flag (LEARNF).** LEARNF indicates that the current-charge cycle can be used to learn the battery capacity. LEARNF is set when the active-empty point is detected. This occurs when the average of the voltages on  $V_{IN1}$  and  $V_{IN2}$  drops below the VAE threshold and the two previous current register values were negative and greater in magnitude than the IAE threshold. See the *Active-Empty Point Detect* section for additional information. LEARNF is cleared when any of the following occur:

- 1) Learn cycle completes (CHGTF set).
- 2) Current register value becomes negative indicating discharge current flow.
- 3)  $ACR = 0$ .
- 4) ACR value is written or recalled from EEPROM.
- 5) Sleep mode is entered.

LEARNF is read-only.

**Bit 3 to 0: Reserved.**

## 2-Cell, Stand-Alone, Li+ Fuel-Gauge IC with Protector and Optional SHA-1 Authentication

### Control Register Format

All Control register bits are read and write accessible. The Control register is recalled from parameter EEPROM memory at power-up. Register bit values can be modified in shadow RAM after power-up. Power-up default values are saved by using the Copy Data command.

#### Control Register (60h)

BIT 7	BIT 6	BIT 5	BIT 4	BIT 3	BIT 2	BIT 1	BIT 0
NBEN	UVEN	PMOD	RNAOP	VUV1	VUV0	PSPIO	PSDQ

**Bit 7: Negative Blanking Enable (NBEN).** A value of 1 enables blanking of negative current values up to 25 $\mu$ V. A value of 0 disables blanking of negative currents. The power-up default of NBEN = 0.

**Bit 6: Undervoltage Enable (UVEN).** A value of 1 allows the DS2775–DS2778 to enter sleep mode when the average of the voltages on VIN1 and VIN2 is less than VUV and DQ is stable at either logic level for tSLEEP. A value of 0 disables transitions to sleep mode during an undervoltage condition.

**Bit 5: Power-Mode Enable (PMOD).** A value of 1 allows the DS2775–DS2778 to enter sleep mode when DQ is low for tSLEEP. A value of 0 disables DQ-related transitions to sleep mode.

**Bit 4: Read Net Address Op Code (RNAOP).** A value of 0 selects 33h as the op code value for the Read Net Address command. A value of 1 selects 39h as the op code value for the Read Net Address command.

**Bit 3 and 2: Undervoltage Threshold (VUV[1:0]).** Sets the voltage at which the part detects an undervoltage condition according to Table 4.

**Bit 1: Power-Switch PIO Enable (PSPIO).** A value of 1 enables the PIO pin as a power-switch input. A value of 0 disables the power-switch input function on PIO pin. This control is independent of the PSDQ state.

**Bit 0: Power-Switch DQ Enable (PSDQ).** A value of 1 enables the DQ pin as a power-switch input. A value of 0 disables the power-switch input function on DQ pin. This control is independent of the PSPIO state. This bit has no effect in the DS2777/DS2778.

**Table 4. Undervoltage Threshold**

VUV[1:0] BIT FIELD	Vuv (V)
00	2.00
01	2.30
10	2.45
11	2.60

DS2775/DS2776/DS2777/DS2778

## 2-Cell, Stand-Alone, Li+ Fuel-Gauge IC with Protector and Optional SHA-1 Authentication

### Overvoltage Threshold Register Format

The 8-bit Overvoltage Threshold register (VOV) sets the overvoltage threshold for the protection circuitry. An overvoltage condition is detected if either of the voltages on VIN1 or VIN2 exceeds the OV threshold for TOVD. The LSB of the VOV register is  $2 \times 5V/1024 = 31.25mV$ . The VOV set point can be calculated by the following formula.

$$V_{OV} = (678 + 2 \times \text{Overvoltage\_Threshold\_Register\_Value}) \times 5V/1024$$

Example:

Overvoltage Threshold register = 1110110b = 118D

$$V_{OV} = (678 + 2 \times 118) \times 5V/1024 = 4.46289V$$

### Overvoltage Threshold Register (7Fh)

BIT 7	BIT 6	BIT 5	BIT 4	BIT 3	BIT 2	BIT 1	BIT 0
X	VOV6	VOV5	VOV4	VOV3	VOV2	VOV1	VOV0

Table 5. VOV Register Programmability

VOV[6:0] BIT FIELD	Vov
0000000	3.311
0000001	3.320
0000010	3.330
0000011	3.340
0000100	3.350
0000101	3.359
0000110	3.369
0000111	3.379
0001000	3.389
0001001	3.398
0001010	3.408
0001011	3.418
0001100	3.428
0001101	3.438
0001110	3.447
0001111	3.457
...	...

VOV[6:0] BIT FIELD	Vov
1110000	4.404
1110001	4.414
1110010	4.424
1110011	4.434
1110100	4.443
1110101	4.453
1110110	4.463
1110111	4.473
1111000	4.482
1111001	4.492
1111010	4.502
1111011	4.512
1111100	4.521
1111101	4.531
1111110	4.541
1111111	4.551

## 2-Cell, Stand-Alone, Li+ Fuel-Gauge IC with Protector and Optional SHA-1 Authentication

### Overcurrent Thresholds

The overcurrent thresholds are set in the upper nibble of the RSGAIN register. The OC1 and OC0 bits set the overcurrent thresholds for the charge and discharge thresholds. The short-circuit threshold is set by the SC0 bit (see Tables 6 and 7, respectively, for overcurrent and short-circuit threshold values). The DS2775–DS2778 have a built-in fixed delay of  $t_{OCD}$  for overcurrent events and  $t_{SCD}$  for short-circuit events. This means that the current ADC must read a value greater than the overcurrent threshold for longer than  $t_{OCD}$  and greater than the short-circuit threshold for longer than  $t_{SCD}$  before turning off the FET. Overcurrent and short-circuit events less than their respective delays are ignored.

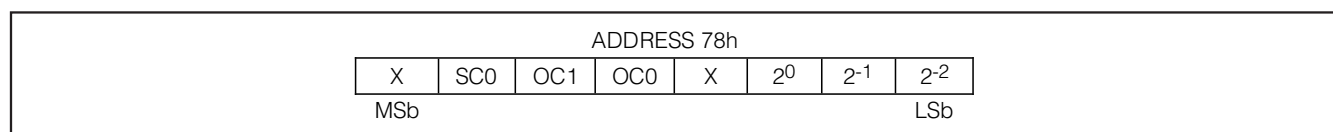

Figure 20. Overcurrent and Short-Circuit Threshold Bits Format

Table 6. COC, DOC Programmability

OC[1:0] BIT FIELD	V <sub>coc</sub> (mV)	V <sub>doc</sub> (mV)
0 0	-25	38
0 1	-38	50
1 0	-50	75
1 1	-75	100

Table 7. SC Programmability

SC0 BIT FIELD	V <sub>sc</sub> (mV)
0	150
1	300

### Special Feature Register Format

All register bits are read and write accessible with default values specified in each bit definition.

#### Special Feature Register (15h)

BIT 7	BIT 6	BIT 5	BIT 4	BIT 3	BIT 2	BIT 1	BIT 0
X	X	X	X	X	X	SHA_IDLE	PIOB

#### Bits 7 to 2: Reserved.

**Bit 1: SHA Idle Bit (SHA\_IDLE).** For the DS2777/DS2778, this bit reads logic 1 while an SHA calculation is in progress and reads logic 0 when the calculation is complete.

**Bit 0: PIO Pin Sense and Control Bit (PIOB).** Writing a 0 to the PIOB bit activates the PIO pin open-drain output driver, forcing the PIO pin low. Writing a 1 to PIOB disables the output driver, allowing the PIO pin to be pulled high or used as an input. Reading PIOB returns the logic level forced on the PIO pin. Note that if the PIO pin is left unconnected with PIOB set, a weak pulldown current source pulls the PIO pin to V<sub>SS</sub>. PIOB is set to a 1 on power-up. PIOB is also set in sleep mode to ensure the PIO pin is high-impedance in sleep mode. **Note:** Do not write PIOB to 0 if PSPIO is enabled.

## 2-Cell, Stand-Alone, Li+ Fuel-Gauge IC with Protector and Optional SHA-1 Authentication

### EEPROM Register

The EEPROM register provides access control of the EEPROM blocks. EEPROM blocks can be locked to prevent alteration of data within the block. Locking a block disables write access to the block. Once a block is locked, it cannot be unlocked. Read access to EEPROM blocks is unaffected by the lock/unlock status.

#### EEPROM Register Format (1Fh)

BIT 7	BIT 6	BIT 5	BIT 4	BIT 3	BIT 2	BIT 1	BIT 0
EEC	LOCK	X	X	X	X	BL1	BL0

**Bit 7: EEPROM Copy Flag (EEC).** A 1 in this read-only bit indicates that a Copy Data command is in progress. While this bit is high, writes to EEPROM addresses are ignored. A 0 value in this bit indicates that data can be written to unlocked EEPROM.

**Bit 6: EEPROM Lock Enable (LOCK).** When the LOCK bit is 0, the Lock command is ignored. Writing a 1 to this bit enables the Lock command. After setting the LOCK bit, the Lock command must be issued as the next command, else the LOCK bit is reset to 0. After the lock operation is completed, the LOCK bit is reset to 0. The LOCK bit is a volatile R/W bit, initialized to 0 upon POR.

**Bits 5 to 2: Reserved.**

**Bit 1: Parameter EEPROM Block 1 Lock Flag (BL1).** A 1 in this read-only bit indicates that EEPROM block 1 (addresses 60h to 80h) is locked (read-only), while a 0 indicates block 1 is unlocked (read/write).

**Bit 0: User EEPROM Block 0 Lock Flag (BL0).** A 1 in this read-only bit indicates that EEPROM block 0 (addresses 20h to 2Fh) is locked (read-only), while a 0 indicates block 0 is unlocked (read/write).

## 2-Cell, Stand-Alone, Li+ Fuel-Gauge IC with Protector and Optional SHA-1 Authentication

### Memory

The DS2775–DS2778 have a 256-byte linear memory space with registers for instrumentation, status, and control, as well as EEPROM memory blocks to store parameters and user information. Byte addresses designated as “reserved” typically return FFh when read. These bytes should not be written. Several byte registers are paired into 2-byte registers to store 16-bit values. The MSB of the 16-bit value is located at the even address and the LSB is located at the next address (odd) byte. When the MSB of a 2-byte register is read, the MSB and LSB are latched simultaneously and held for the duration of the Read Data command to prevent updates to the LSB during the read. This ensures synchronization between the two register bytes. For consistent results, always read the MSB and the LSB of a 2-byte register during the same Read Data sequence.

EEPROM memory consists of nonvolatile EEPROM cells overlaying volatile shadow RAM. The Read Data and Write Data commands allow the 1-Wire interface to directly access the shadow RAM (Figure 21). The Copy Data and Recall Data commands transfer data between the EEPROM cells and the shadow RAM. In order to modify the data stored in the EEPROM cells, data must be written to the shadow RAM and then copied to the EEPROM. To verify the data stored in the EEPROM cells, the EEPROM data must be recalled to

the shadow RAM and then read from the shadow. After issuing the Copy Data command, access to the EEPROM block is not available until the EEPROM copy completes (see t<sub>EEC</sub> in the *EEPROM Reliability Specification* table).

### User EEPROM—Block 0

A 16-byte user EEPROM memory (block 0, addresses 20h to 2Fh) provides nonvolatile memory that is uncommitted to other DS2775–DS2778 functions. Accessing the user EEPROM block does not affect the operation of the DS2775–DS2778. User EEPROM is lockable and, once locked, write access is not allowed. The battery pack or host system manufacturer can program lot codes, date codes, and other manufacturing or warranty or diagnostic information and then lock it to safeguard the data. User EEPROM can also store parameters for charging to support different size batteries in a host device as well as auxiliary model data such as time to full-charge estimation parameters.

### Parameter EEPROM—Block 1

Model data for the cells as well as application operating parameters are stored in the parameter EEPROM memory (block 1, addresses 60h to 80h). The ACR (MSB and LSB) and AS registers are automatically saved to EEPROM when the RARC result crosses 4% boundaries (see Table 8 for more information).

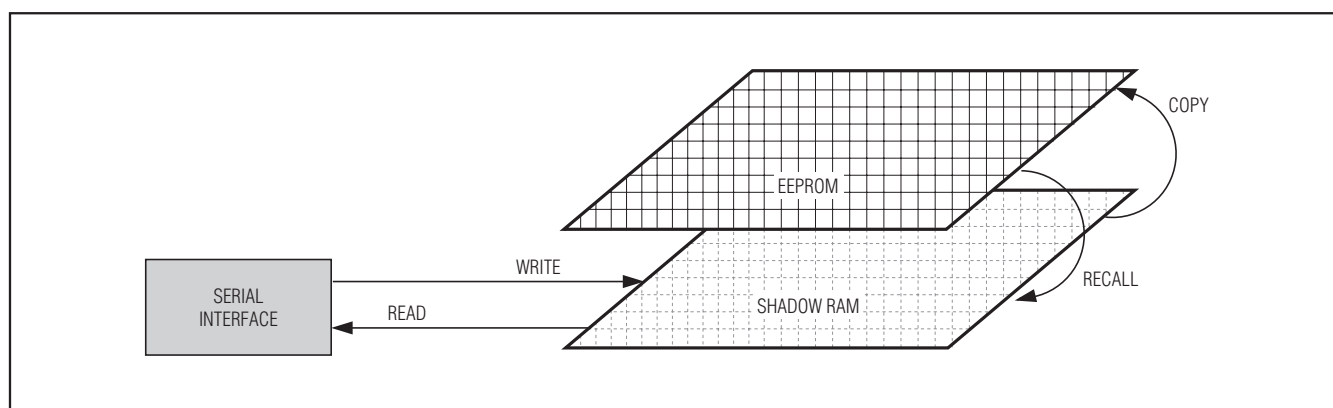

Figure 21. EEPROM Access Through Shadow RAM

DS2775/DS2776/DS2777/DS2778

## 2-Cell, Stand-Alone, Li+ Fuel-Gauge IC with Protector and Optional SHA-1 Authentication

Table 8. Parameter EEPROM Memory Block

ADDRESS (HEX)	DESCRIPTION	ADDRESS (HEX)	DESCRIPTION
60h	Control Register	71h	AE Segment 3 Slope Register
61h	Accumulation Bias Register (AB)	72h	AE Segment 2 Slope Register
62h	Aging Capacity Register MSB (AC)	73h	AE Segment 1 Slope Register
63h	Aging Capacity Register LSB (AC)	74h	SE Segment 4 Slope Register
64h	Charge Voltage Register (VCHG)	75h	SE Segment 3 Slope Register
65h	Minimum Charge Current Register (IMIN)	76h	SE Segment 2 Slope Register
66h	Active-Empty Voltage Register (VAE)	77h	SE Segment 1 Slope Register
67h	Active-Empty Current Register (IAE)	78h	Sense-Resistor Gain Register MSB (RSGAIN)
68h	Active-Empty 40 Register	79h	Sense-Resistor Gain Register LSB (RSGAIN)
69h	Sense Resistor Prime Register (RSNSP)	7Ah	Sense-Resistor Temperature Coefficient Register (RSTC)
6Ah	Full 40 MSB Register		
6Bh	Full 40 LSB Register	7Bh	Current Offset Bias Register (COB)
6Ch	Full Segment 4 Slope Register	7Ch	TBP34 Register
6Dh	Full Segment 3 Slope Register	7Dh	TBP23 Register
6Eh	Full Segment 2 Slope Register	7Eh	TBP12 Register
6Fh	Full Segment 1 Slope Register	7Fh	Protector Threshold Register
70h	AE Segment 4 Slope Register	80h	2-Wire Slave Address Register

Table 9. Memory Map

ADDRESS (HEX)	DESCRIPTION	READ/WRITE
00h	Protection Register	R/W
01h	Status Register	R/W
02h	RAAC Register MSB	R
03h	RAAC Register LSB	R
04h	RSAC Register MSB	R
05h	RSAC Register LSB	R
06h	RARC Register	R
07h	RSRC Register	R
08h	Average Current Register MSB	R
09h	Average Current Register LSB	R
0Ah	Temperature Register MSB	R
0Bh	Temperature Register LSB	R
0Ch	Voltage Register MSB, $V_{IN1} - V_{SS}$	R
0Dh	Voltage Register LSB, $V_{IN1} - V_{SS}$	R
0Eh	Current Register MSB	R
0Fh	Current Register LSB	R
10h	Accumulated Current Register MSB	R/W*
11h	Accumulated Current Register LSB	R/W*
12h	Accumulated Current Register LSB - 1	R



## 2-Cell, Stand-Alone, Li+ Fuel-Gauge IC with Protector and Optional SHA-1 Authentication

Table 9. Memory Map (continued)

ADDRESS (HEX)	DESCRIPTION	READ/WRITE
13h	Accumulated Current Register LSB - 2	R
14h	Age Scalar Register	R/W*
15h	Special Feature Register	R/W
16h	Full Register MSB	R
17h	Full Register LSB	R
18h	Active-Empty Register MSB	R
19h	Active-Empty Register LSB	R
1Ah	Standby-Empty Register MSB	R
1Bh	Standby-Empty Register LSB	R
1Ch	Voltage Register MSB, $V_{IN2} - V_{IN1}$	R
1Dh	Voltage Register LSB, $V_{IN2} - V_{IN1}$	R
1Eh	Cycle Counter Register	R/W*
1Fh	EEPROM Register	R/W
20h to 2Fh	User EEPROM Register, Lockable, Block 0	R/W
30h to 5Fh	Reserved	—
60h to 80h	Parameter EEPROM Register, Lockable, Block 1	R/W
81h to AFh	Reserved	—
B0h	Factory Gain RSGAIN Register MSB	R
B1h	Factory Gain RSGAIN Register LSB	R
B2h to FDh	Reserved	—
FEh	2-Wire Command Register	W
FFh	Reserved	—

\*Register value is automatically saved to EEPROM during active-mode operation and recalled from EEPROM on power-up.

### 64-Bit Net Address (ROM ID)

Each DS2775–DS2778 has a unique, factory-programmed ROM ID that is 64 bits. The first 8 bits of the net address are the product family code (32h). The next 48 bits are a unique serial number. The last 8 bits are a cyclic redundancy check (CRC) of the first 56 bits (see Figure 22).

### Authentication

The DS2776/DS2778 have an authentication feature that is performed using a FIPS 180-compliant SHA-1 one-way hash algorithm on a 512-bit message block. The message block consists of a 64-bit secret, a 64-bit

challenge, and 384 bits of constant data. Optionally, the 64-bit net address replaces 64 of the 384 bits of constant data used in the hash operation. Contact Maxim for details of the message block organization.

The host and the DS2776/DS2778 both calculate the result based on the mutually known secret. The result data, known as the message authentication code (MAC) or message digest, is returned by the DS2776/DS2778 for comparison to the host's result. Note that the secret is never transmitted on the bus and thus cannot be captured by observing bus traffic. Each authentication attempt is initiated by the host system by providing a 64-bit random challenge through the Write

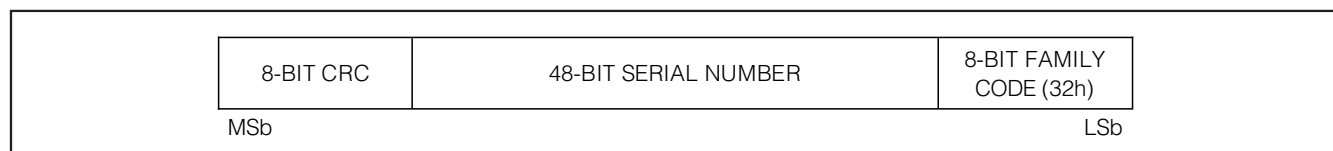

Figure 22. 1-Wire Net Address Format (ROM ID)

## 2-Cell, Stand-Alone, Li+ Fuel-Gauge IC with Protector and Optional SHA-1 Authentication

DS2775/DS2776/DS2777/DS2778

Challenge command. The host then issues the Compute MAC or Compute MAC with ROM ID command. The MAC is computed per FIPS 180, and then returned as a 160-bit serial stream, beginning with the LSB.

### DS2776/DS2778 Authentication Commands

#### Write Challenge [0Ch]

This command writes the 64-bit challenge to the DS2776/DS2778. The LSB of the 64-bit data argument can begin immediately after the MSB of the command has been completed. If more than 8 bytes are written, the final value in the Challenge register is indeterminate. The Write Challenge command must be issued prior to every Compute MAC or Compute Next Secret command for reliable results.

#### Compute MAC without ROM ID [36h]

This command initiates an SHA-1 computation without including the ROM ID in the message block. Because the ROM ID is not used, this command allows the use of a master secret and MAC response independent of the ROM ID. The DS2776/DS2778 computes the MAC in  $t_{SHA}$  after receiving the last bit of this command. After the MAC computation is complete, the host must write eight write-zero time slots and then issue 160 read time slots to receive the 20-byte MAC. See Figure 25 for command timing.

#### Compute MAC with ROM ID [35h]

This command is structured the same as the Compute MAC without ROM ID, except that the ROM ID is included in the message block. With the ROM ID unique to each DS2776/DS2778 included in the MAC computation, use of a unique secret in each token and a master secret in the host device is allowed. Refer to Application Note 1099: *White Paper 4: Glossary of 1-Wire SHA-1 Terms* for more information. See Figure 25 for command timing.

Table 10 summarizes SHA-1-related commands used while authenticating a battery or peripheral device. The *Secret Management Function Commands* section describes four additional commands for clearing, computing, and locking of the secret.

### Secret Management Function Commands

Table 11 summarizes all the secret management function commands.

#### Clear Secret [5Ah]

This command sets the 64-bit secret to all 0s (0000 0000 0000 0000h). The host must wait for  $t_{EEC}$  for the DS2776/DS2778 to write the new secret value to EEPROM. See Figure 28 for command timing.

#### Compute Next Secret without ROM ID [30h]

This command initiates an SHA-1 computation of the MAC and uses a portion of the resulting MAC as the next or new secret. The MAC computation is performed with the current 64-bit secret and the 64-bit challenge. Logical 1s are loaded in place of the ROM ID. The output MAC's 64 bits are used as the new secret value. The host must allow  $t_{SHA}$  after issuing this command for the SHA calculation to complete, then wait  $t_{EEC}$  for the DS2776/DS2778 to write the new secret value to EEPROM. See Figure 26 for command timing.

#### Compute Next Secret with ROM ID [33h]

This command initiates an SHA-1 computation of the MAC and uses a portion of the resulting MAC as the next or new secret. The MAC computation is performed with the current 64-bit secret, the 64-bit ROM ID, and the 64-bit challenge. The output MAC's 64 bits are used as the new secret value. The host must allow  $t_{SHA}$  after issuing this command for the SHA calculation to complete, then wait  $t_{EEC}$  for the DS2776/DS2778 to write

**Table 10. Authentication Function Commands**

COMMAND	HEX	FUNCTION
Write Challenge	0Ch	Writes 64-bit challenge for SHA-1 processing. Required prior to issuing Compute MAC and Compute Next Secret commands.
Compute MAC without ROM ID (and Return MAC for the DS2776 only)	36h	Computes hash of the message block with logical 1s in place of the ROM ID. (Returns the 160-bit MAC for the DS2776 only.)
Compute MAC with ROM ID (and Return MAC for the DS2776 only)	35h	Computes hash of the message block including the ROM ID. (Returns the 160-bit MAC for the DS2776 only.)
Read ROM ID (DS2778 only)	39h	Returns the ROM ID (DS2778 only).
Read MAC (DS2778 only)	3Ah	Returns the 160-bit MAC (DS2778 only).



## 2-Cell, Stand-Alone, Li+ Fuel-Gauge IC with Protector and Optional SHA-1 Authentication

also used to provide verification of error-free data transfer as each EEPROM page is sent to the master during a Read Data/Generate CRC command and for the 8 bytes of information in the status memory field.

In each case where a CRC is used for data transfer validation, the bus master must calculate the CRC value using the same polynomial function and compare the calculated value to the CRC either stored in the DS2775/DS2776 net address or computed by the DS2775/DS2776. The comparison of CRC values and decision to continue with an operation are determined entirely by the bus master. There is no circuitry in the DS2775/DS2776 that prevents a command sequence from proceeding if the stored or calculated CRC from the DS2775/DS2776 and the calculated CRC from the host do not match.

### Hardware Configuration

Because the 1-Wire bus has only a single line, it is important that each device on the bus be able to drive it at the appropriate time. To facilitate this, each device attached to the 1-Wire bus must connect to the bus with open-drain or three-state output drivers. The DS2775/DS2776 use an open-drain output driver as part of the bidirectional interface circuitry shown in Figure 24. If a bidirectional pin is not available on the bus master, separate output and input pins can be connected together.

The 1-Wire bus must have a pullup resistor at the bus master end. A value of between  $2k\Omega$  and  $5k\Omega$  is recommended. The idle state for the 1-Wire bus is high. If, for any reason, a bus transaction must be suspended, the bus must be left in the idle state to properly resume the transaction later. Note that if the bus is left low for more than  $t_{LOW0}$ , slave devices on the bus begin to interpret

the low period as a reset pulse, effectively terminating the transaction.

### Transaction Sequence

The protocol for accessing the DS2775/DS2776 through the 1-Wire port is as follows:

- Initialization
- Net Address Commands
- Function Command(s)
- Data Transfer (not all commands have data transfer)

#### Initialization

All transactions of the 1-Wire bus begin with an initialization sequence consisting of a reset pulse transmitted by the bus master, followed by a presence pulse simultaneously transmitted by the DS2775/DS2776 and any other slaves on the bus. The presence pulse tells the bus master that one or more devices are on the bus and ready to operate. For more details, see the *1-Wire Signaling* section.

#### Net Address Commands

Once the bus master has detected the presence of one or more slaves, it can issue one of the net address commands described in the following sections. The name of each Net Address command (ROM command) is followed by the 8-bit op code for that command in square brackets.

#### Read Net Address [33h]

This command allows the bus master to read the DS2775/DS2776's 1-Wire net address. This command can only be used if there is a single slave on the bus. If more than one slave is present, a data collision occurs when all slaves try to transmit at the same time (open drain produces a wired-AND result).

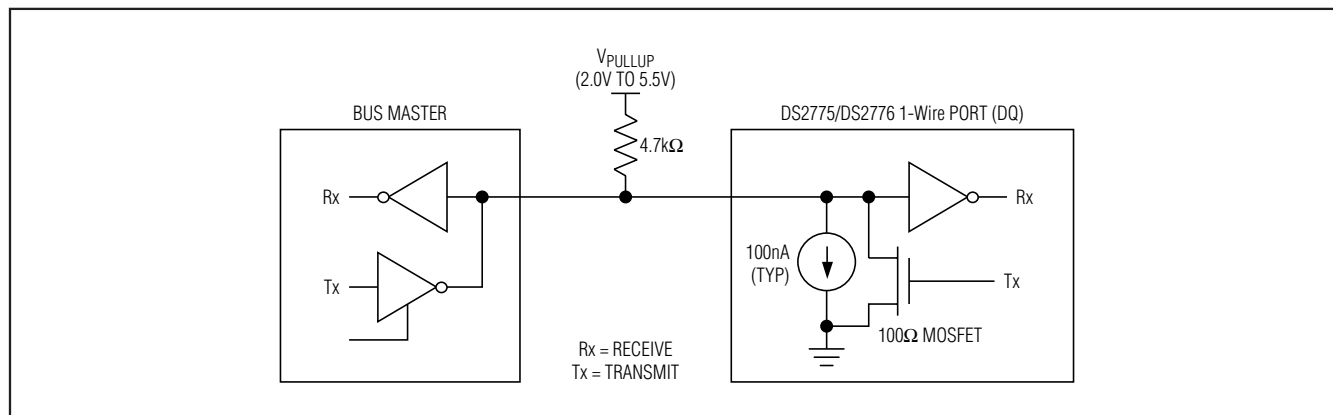

Figure 24. 1-Wire Bus Interface Circuitry

## 2-Cell, Stand-Alone, Li+ Fuel-Gauge IC with Protector and Optional SHA-1 Authentication

### Match Net Address [55h]

This command allows the bus master to specifically address one DS2775/DS2776 on the 1-Wire bus. Only the addressed DS2775/DS2776 responds to any subsequent function command. All other slave devices ignore the function command and wait for a reset pulse. This command can be used with one or more slave devices on the bus.

### Skip Net Address [CCh]

This command saves time when there is only one DS2775/DS2776 on the bus by allowing the bus master to issue a function command without specifying the address of the slave. If more than one slave device is present on the bus, a subsequent function command can cause a data collision when all slaves transmit data at the same time.

### Search Net Address [F0h]

This command allows the bus master to use a process of elimination to identify the 1-Wire net addresses of all slave devices on the bus. The search process involves the repetition of a simple three-step routine: read a bit, read the complement of the bit, then write the desired value of that bit. The bus master performs this simple three-step routine on each bit location of the net address. After one complete pass through all 64 bits, the bus master knows the address of one device. The remaining devices can then be identified on additional iterations of the process. See Chapter 5 in Application Note 937: *Book of iButton Standards* for a comprehensive discussion of a net address search, including an actual example.

### Function Commands

After successfully completing one of the net address commands, the bus master can access the features of the DS2775/DS2776 with any of the function commands described in the following paragraphs. The name of each function is followed by the 8-bit op code for that command in square brackets. The function commands are summarized in Table 12. Table 13 details the requirements for using the function commands.

### Read Data [69h, XXh]

This command reads data from the DS2775/DS2776 starting at memory address XXh. The LSb of the data in address XXh is available to be read immediately after the MSb of the address has been entered. Because the address is automatically incremented after the MSb of each byte is received, the LSb of the data at address XXh + 1 is available to be read immediately after the MSb of the data at address XXh. If the bus master continues to read beyond address FFh, data is read start-

ing at memory address 00h and the address is automatically incremented until a reset pulse occurs. Addresses labeled Reserved in the *Memory Map* contain undefined data values (see Table 9). The Read Data command can be terminated by the bus master with a reset pulse at any bit boundary. Reads from EEPROM block addresses return the data in the shadow RAM. A Recall Data command is required to transfer data from the EEPROM to the shadow. See the *Memory* section for more details.

### Write Data [6Ch, XXh]

This command writes data to the DS2775/DS2776 starting at memory address XXh. The LSb of the data to be stored at address XXh can be written immediately after the MSb of the address has been entered. Because the address is automatically incremented after the MSb of each byte is written, the LSb to be stored at address XXh + 1 can be written immediately after the MSb to be stored at address XXh. If the bus master continues to write beyond address FFh, the data starting at address 00 is overwritten. Writes to read-only addresses, reserved addresses, and locked EEPROM blocks are ignored. Incomplete bytes are not written. Writes to unlocked EEPROM block addresses modify the shadow RAM. A Copy Data command is required to transfer data from the shadow to the EEPROM. See the *Memory* section for more details.

### Copy Data [48h, XXh]

This command copies the contents of the EEPROM shadow RAM to EEPROM cells for the EEPROM block containing address XXh. Copy Data commands that address locked blocks are ignored. While the Copy Data command is executing, the EEC bit in the EEPROM register is set to 1 and writes to EEPROM addresses are ignored. Reads and writes to non-EEPROM addresses can still occur while the copy is in progress. The Copy Data command takes  $t_{EEC}$  time to execute, starting on the next falling edge after the address is transmitted. See Figure 27 for more information.

### Recall Data [B8h, XXh]

This command recalls the contents of the EEPROM cells to the EEPROM shadow memory for the EEPROM block containing address XXh.

### Lock [6Ah, XXh]

This command locks (write protects) the block of EEPROM memory containing memory address XXh. The LOCK bit in the EEPROM register must be set to 1 before the Lock command is executed. To help prevent unintentional locks, one must issue the Lock command immediately after setting the LOCK bit (EEPROM

DS2775/DS2776/DS2777/DS2778

## 2-Cell, Stand-Alone, Li+ Fuel-Gauge IC with Protector and Optional SHA-1 Authentication

register, address 1Fh, bit 6) to a 1. If the LOCK bit is 0 or if setting the LOCK bit to 1 does not immediately precede the Lock command, the Lock command has

no effect. The Lock command is permanent; a locked block can never be written again.

**Table 12. All Function Commands**

COMMAND	HEX	DESCRIPTION
Write Challenge	0Ch	Writes 64-bit challenge for SHA-1 processing. Required immediately prior to all Compute MAC and Compute Next Secret commands.
Compute MAC without ROM ID (and Return MAC for the DS2776 only)	36h	Computes hash of the message block with logical 1s in place of ROM ID. (Returns the 160-bit MAC for the DS2776 only.)
Compute MAC with ROM ID (and Return MAC for the DS2776 only)	35h	Computes hash of the message block using the ROM ID. (Returns the 160-bit MAC for the DS2776 only.)
Clear Secret	5Ah	Clears the 64-bit secret to 0000 0000 0000 0000h.
Compute Next Secret without the ROM ID	30h	Generates new global secret.
Compute Next Secret with ROM ID	33h	Generates new unique secret.
Read ROM ID (DS2778 only)	39h	Returns the ROM ID (DS2778 only).
Read MAC (DS2778 only)	3Ah	Returns the 160-bit MAC (DS2778 only).
Lock Secret	60h	Sets lock bit to prevent changes to the secret.
Read Data	69h, XXh	Reads data from memory starting at address XXh.
Write Data	6Ch, XXh	Writes data to memory starting at address XXh.
Copy Data	48h, XXh	Copies shadow RAM data to EEPROM block containing address XXh.
Recall Data	B8h, XXh	Recalls EEPROM block containing address XXh to RAM.
Lock	6Ah, XXh	Permanently locks the block of EEPROM containing address XXh.
Reset	BBh	Resets DS2775/DS2776 (software POR).

**Table 13. Guide to Function Command Requirements**

COMMAND	ISSUE MEMORY ADDRESS (BITS)	ISSUE 00h BEFORE READ	READ/WRITE TIME SLOTS
Write Challenge	—	—	Write: 64
Compute MAC	—	Yes	Read: Up to 160
Compute Next Secret	—	—	—
Clear/Lock Secret, Set/Clear	—	—	—
Read Data	8	—	Read: Up to 2048
Write Data	8	—	Write: Up to 2048
Copy Data	8	—	—
Recall Data	8	—	—
Lock	8	—	—
Reset	—	—	—

# 2-Cell, Stand-Alone, Li+ Fuel-Gauge IC with Protector and Optional SHA-1 Authentication

DS2775/DS2776/DS2777/DS2778

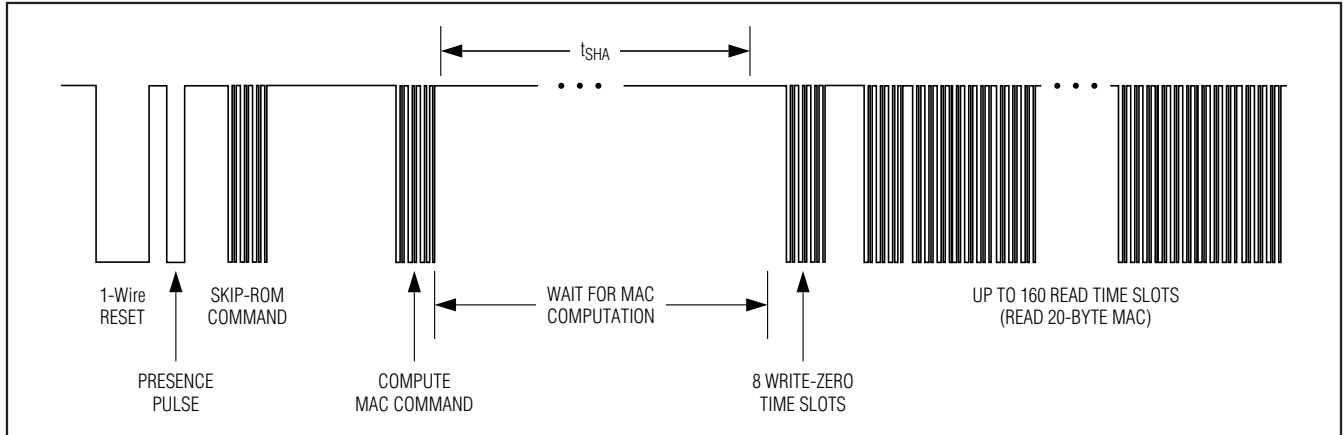

Figure 25. Compute MAC Command

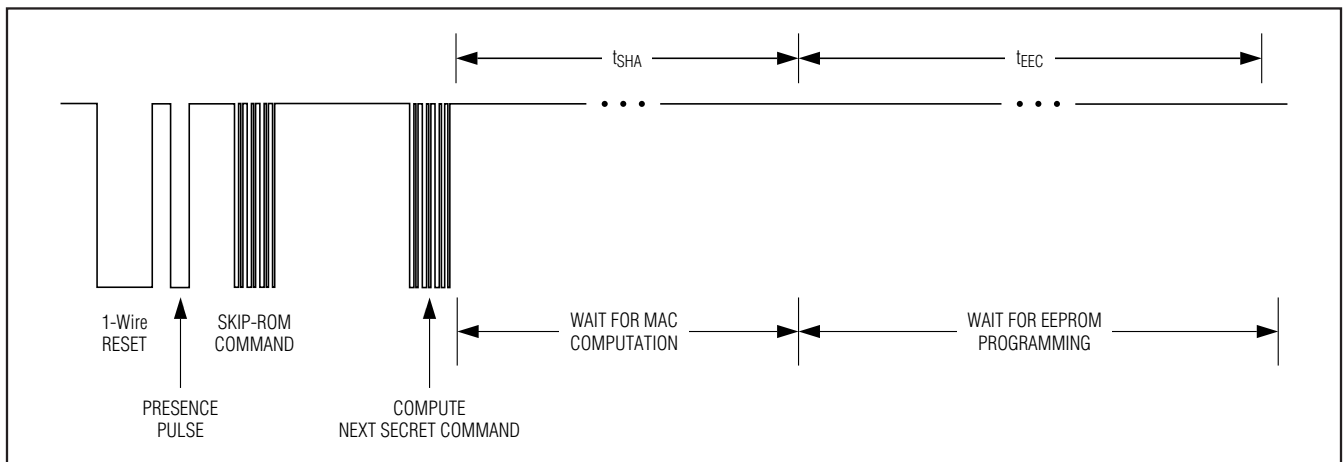

Figure 26. Compute Next Secret Command

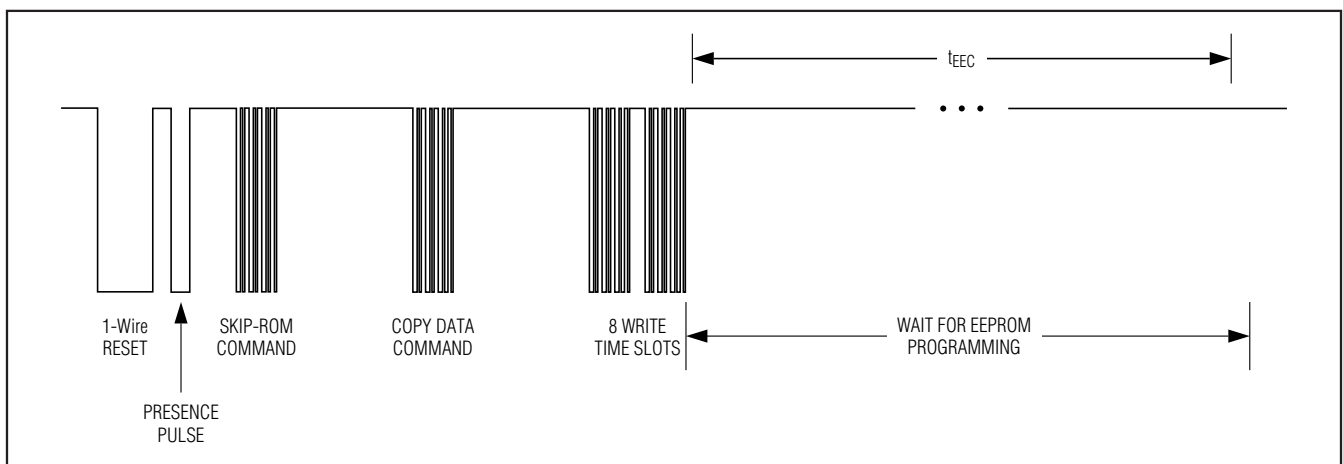

Figure 27. Copy Data Command

## 2-Cell, Stand-Alone, Li+ Fuel-Gauge IC with Protector and Optional SHA-1 Authentication

DS2775/DS2776/DS2777/DS2778

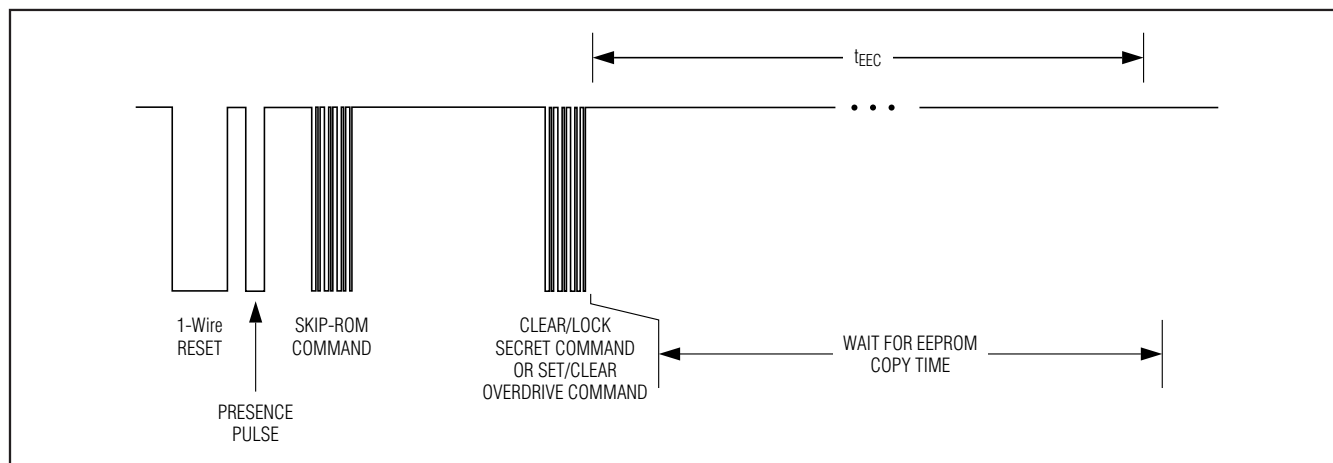

Figure 28. Clear/Lock Secret, Set/Clear Overdrive Commands

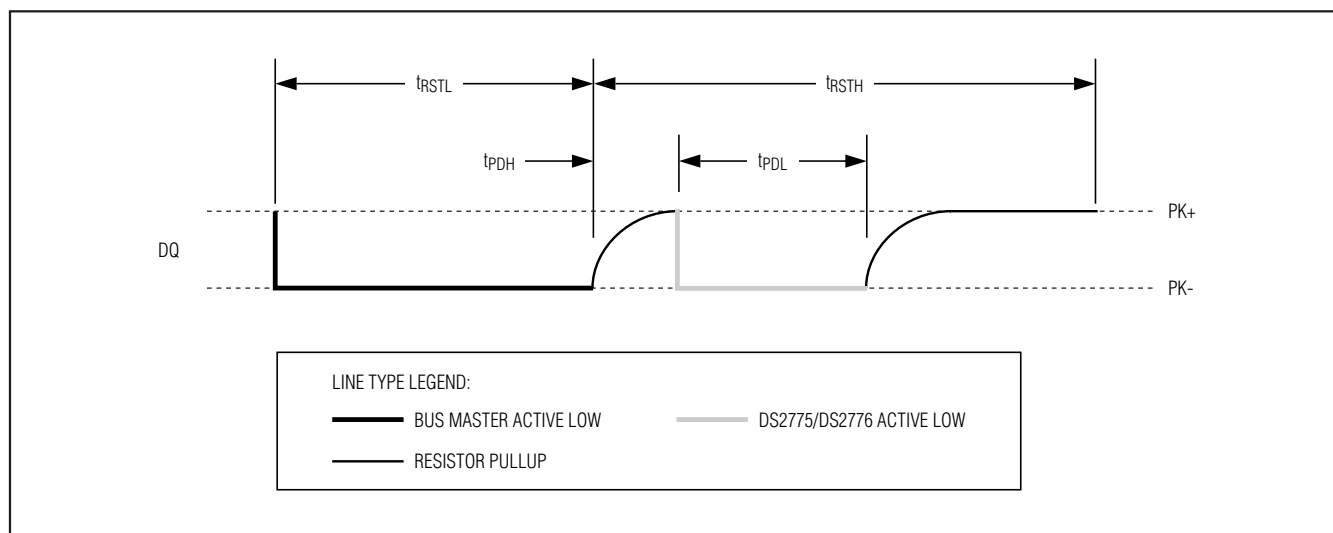

Figure 29. 1-Wire Initialization Sequence

### 1-Wire Signaling

The 1-Wire bus requires strict signaling protocols to ensure data integrity. The four protocols used by the DS2775/DS2776 are as follows: the initialization sequence (reset pulse followed by presence pulse), write-zero, write-one, and read data. The bus master initiates all these types of signaling except the presence pulse.

Figure 29 shows the initialization sequence required to begin any communication with the DS2775/DS2776. A presence pulse following a reset pulse indicates that the DS2775/DS2776 are ready to accept a Net Address command. The bus master transmits (Tx) a reset pulse for  $t_{RSTL}$ . The bus master then releases the line and goes into receive mode (Rx). The 1-Wire bus line is then pulled high by the pullup resistor. After detecting the rising edge on the DQ pin, the DS2775/DS2776 wait for  $t_{PDH}$  and then transmit the presence pulse for  $t_{PDL}$ .



# 2-Cell, Stand-Alone, Li+ Fuel-Gauge IC with Protector and Optional SHA-1 Authentication

DS2775/DS2776/DS2777/DS2778

## Write Time Slots

A write time slot is initiated when the bus master pulls the 1-Wire bus from a logic-high (inactive) level to a logic-low level. There are two types of write time slots: write-one and write-zero. All write time slots must be  $t_{SLOT}$  in duration with a  $1\mu s$  minimum recovery time,  $t_{REC}$ , between cycles. The DS2775/DS2776 sample the 1-Wire bus line between  $t_{LOW1\_MAX}$  and  $t_{LOW0\_MIN}$  after the line falls. If the line is high when sampled, a write-one occurs. If the line is low when sampled, a write-zero occurs. Figure 30 illustrates the sample window. For the bus master to generate a write-one time slot, the bus line must be pulled low and then released, allowing the line to be pulled high less than  $t_{RDV}$  after the start of the write time slot. For the host to generate a write-zero time slot, the bus line must be pulled low and held low for the duration of the write time slot.

## Read Time Slots

A read time slot is initiated when the bus master pulls the 1-Wire bus line from a logic-high level to a logic-low level. The bus master must keep the bus line low for at least  $1\mu s$  and then release it to allow the DS2775/DS2776 to present valid data. The bus master can then sample the data  $t_{RDV}$  from the start of the read time slot. By the end of the read time slot, the DS2775/DS2776 release the bus line and allow it to be pulled high by the external pullup resistor. All read time slots must be  $t_{SLOT}$  in duration with a  $1\mu s$  minimum recovery time,  $t_{REC}$ , between cycles. See Figure 30 and the timing specifications in the *Electrical Characteristics: 1-Wire Interface, Standard/Overdrive* tables for more information.

## 2-Wire Bus System

The 2-wire bus system supports operation as a slave-only device in a single or multislave and single or multi-master system. Up to 128 slave devices can share the bus by uniquely setting the 7-bit slave address. The 2-wire interface consists of a serial data line (SDA) and serial clock line (SCL). SDA and SCL provide bidirectional communication between the DS2777/DS2778 slave device and a master device at speeds up to 400kHz. The DS2777/DS2778's SDA pin operates bidirectionally, that is, when the DS2777/DS2778 receive data, SDA operates as an input, and when the DS2777/DS2778 return data, SDA operates as an open-drain output with the host system providing a resistive pullup. The DS2777/DS2778 always operate as a slave device, receiving and transmitting data under the con-

trol of a master device. The master initiates all transactions on the bus and generates the SCL signal as well as the START and STOP bits which begin and end each transaction.

## Bit Transfer

One data bit is transferred during each SCL clock cycle with the cycle defined by SCL transitioning low-to-high and then high-to-low. The SDA logic level must remain stable during the high period of the SCL clock pulse. Any change in SDA when SCL is high is interpreted as a START (S) or STOP (P) control signal.

## Bus Idle

The bus is defined to be idle, or not busy, when no master device has control. Both SDA and SCL remain high when the bus is idle. The STOP condition is the proper method to return the bus to the idle state.

## START and STOP Conditions

The master initiates transactions with a START condition by forcing a high-to-low transition on SDA while SCL is high. The master terminates a transaction with a STOP condition, a low-to-high transition on SDA while SCL is high. A repeated START condition ( $S_r$ ) can be used in place of a STOP then START sequence to terminate one transaction and begin another without returning the bus to the idle state. In multimaster systems, a repeated START allows the master to retain control of the bus. The START and STOP conditions are the only bus activities in which the SDA transitions when SCL is high.

## Acknowledge Bits

Each byte of a data transfer is acknowledged with an acknowledge bit (A) or a not acknowledge bit (N). Both the master and the DS2777/DS2778 slave generate acknowledge bits. To generate an acknowledge, the receiving device must pull SDA low before the rising edge of the acknowledge-related clock pulse (9th pulse) and keep it low until SCL returns low. To generate a not acknowledge (also called NACK), the receiver releases SDA before the rising edge of the acknowledge-related clock pulse and leaves SDA high until SCL returns low. Monitoring the acknowledge bits allows for detection of unsuccessful data transfers. An unsuccessful data transfer can occur if a receiving device is busy or if a system fault has occurred. In the event of an unsuccessful data transfer, the bus master should reattempt communication.

# 2-Cell, Stand-Alone, Li+ Fuel-Gauge IC with Protector and Optional SHA-1 Authentication

DS2775/DS2776/DS2777/DS2778

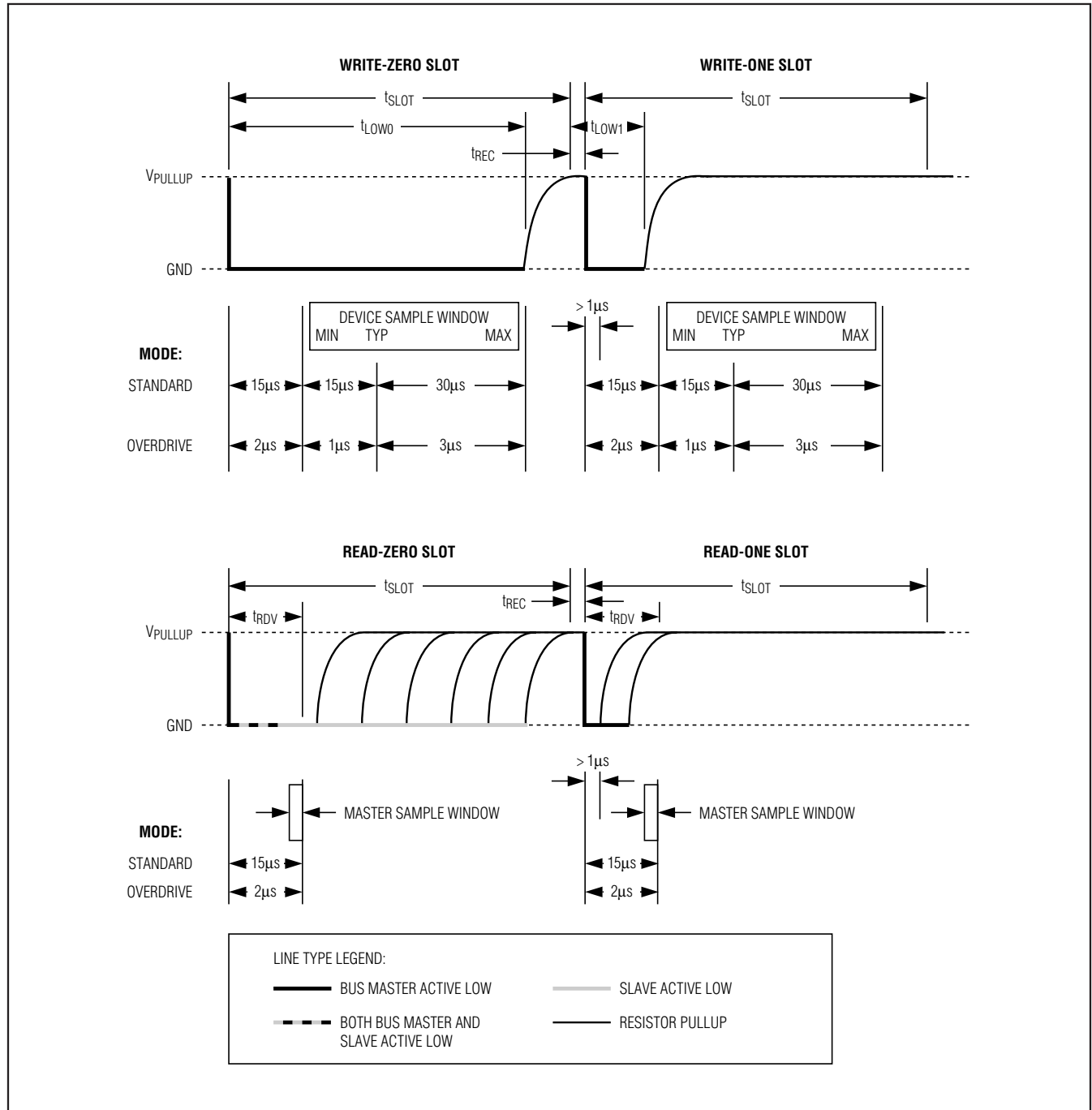

Figure 30. 1-Wire Write and Read Time Slots

# 2-Cell, Stand-Alone, Li+ Fuel-Gauge IC with Protector and Optional SHA-1 Authentication

**DS2775/DS2776/DS2777/DS2778**

## Data Order

A byte of data consists of 8 bits ordered MSb first. The LSB of each byte is followed by the acknowledge bit. The DS2777/DS2778 registers composed of multibyte values are ordered MSB first. The MSB of multibyte registers is stored on even data memory addresses.

## Slave Address

A bus master initiates communication with a slave device by issuing a START condition followed by a slave address (SAddr) and the read/write (R/W) bit. When the bus is idle, the DS2777/DS2778 continuously monitor for a START condition followed by its slave address. When the DS2777/DS2778 receive a slave address that matches the value in its Programmable Slave Address register, they respond with an acknowledge bit during the clock period following the R/W bit. The 7-bit Programmable Slave Address register is factory programmed to 1011001. The slave address can be reprogrammed. See the *Programmable Slave Address* section for details.

## Programmable Slave Address

The 2-wire slave address of the DS2777/DS2778 is stored in the parameter EEPROM block, address 80h. Programming the slave address requires a write to 80h with the desired slave address. The new slave address value is effective following the write to 80h and must be used to address the DS2777/DS2778 on subsequent bus transactions. The slave address value is not stored to EEPROM until a Copy EEPROM Block 1 command is executed. Prior to executing the Copy Data command, power cycling the DS2777/DS2778 restores the original slave address value. The data format of the slave address value in address 80h is shown in the *Slave Address Format (80h)* section.

## Read/Write Bit

The R/W bit following the slave address determines the data direction of subsequent bytes in the transfer. R/W = 0 selects a write transaction, with the subsequent bytes being written by the master to the slave. R/W = 1

selects a read transaction, with the subsequent bytes being read from the slave by the master.

## Bus Timing

The DS2777/DS2778 are compatible with any bus timing up to 400kHz. No special configuration is required to operate at any speed.

## 2-Wire Command Protocols

The command protocols involve several transaction formats. The simplest format consists of the master writing the START bit, slave address, R/W bit, and then monitoring the acknowledge bit for presence of the DS2777/DS2778. More complex formats such as the Write Data, Read Data, and function command protocols write data, read data, and execute device-specific operations. All bytes in each command format require the slave or host to return an acknowledge bit before continuing with the next byte. Each function command definition outlines the required transaction format. Table 14 applies to the transaction formats.

## Basic Transaction Formats

Write: S SAddr W A MAddr A Data0 A P

A write transaction transfers one or more data bytes to the DS2777/DS2778. The data transfer begins at the memory address supplied in the MAddr byte. Control of the SDA signal is retained by the master throughout the transaction, except for the acknowledge cycles.

Read: S SAddr W A MAddr A Sr SAddr R A Data0 N P

Write Portion
Read Portion

A read transaction transfers one or more bytes *from* the DS2777/DS2778. Read transactions are composed of two parts with a write portion followed by a read portion and are, therefore, inherently longer than a write transaction. The write portion communicates the starting point for the read operation. The read portion follows immediately, beginning with a repeated START, and slave address with R/W set to a 1. Control of SDA is

## Slave Address Format (80h)

BIT 7	BIT 6	BIT 5	BIT 4	BIT 3	BIT 2	BIT 1	BIT 0
A6	A5	A4	A3	A2	A1	A0	X

**Bits 7 to 1: Slave Address (A[6:0]).** A[6:0] contains the 7-bit slave address of the DS2777/DS2778. The factory default is 1011001b.

**Bit 0: Reserved.**

## 2-Cell, Stand-Alone, Li+ Fuel-Gauge IC with Protector and Optional SHA-1 Authentication

DS2775/DS2776/DS2777/DS2778

**Table 14. 2-Wire Protocol Key**

KEY	DESCRIPTION	KEY	DESCRIPTION
S	START Bit	Sr	Repeated START
SAddr	Slave Address (7-bit)	W	R/W Bit = 0
FCmd	Function Command Byte	R	R/W Bit = 1
MAddr	Memory Address Byte	P	STOP bit
Data	Data Byte Written by Master	Data	Data Byte Returned by Slave
A	Acknowledge Bit (Master)	A	Acknowledge Bit (Slave)
N	Not Acknowledge (Master)	N	Not Acknowledge (Slave)

assumed by the DS2777/DS2778 beginning with the slave address acknowledge cycle. Control of the SDA signal is retained by the DS2777/DS2778 throughout the transaction, except for the acknowledge cycles. The master indicates the end of a read transaction by responding to the last byte it requires with a no acknowledge. This signals the DS2777/DS2778 that control of SDA is to remain with the master following the acknowledge clock.

### Write-Data Protocol

The write-data protocol is used to write to register and shadow RAM data to the DS2777/DS2778 starting at memory address MAddr. Data0 represents the data written to MAddr, Data1 represents the data written to MAddr + 1 and DataN represents the last data byte, written to MAddr + N. The master indicates the end of a write transaction by sending a STOP or repeated START after receiving the last acknowledge bit.

S SAddr W A MAddr A Data0 A Data1 A ... DataN A P

The MSb of the data to be stored at address MAddr can be written immediately after the MAddr byte is acknowledged. Because the address is automatically incremented after the LSb of each byte is received by the DS2777/DS2778, the MSb of the data at address MAddr + 1 is written immediately after the acknowledgement of the data at address MAddr. If the bus master continues an autoincremented write transaction beyond address 4Fh, the DS2777/DS2778 ignore the data. Data is also ignored on writes to read-only addresses and reserved addresses, locked EEPROM blocks, as well as a write that auto-increments to the Function Command register (address FEh). Incomplete bytes and bytes that are not acknowledged by the DS2777/DS2778 are not written to memory. As noted in the *Memory* section, writes to unlocked EEPROM blocks modify the shadow RAM only.

### Read-Data Protocol

The read-data protocol is used to read register and shadow RAM data from the DS2777/DS2778 starting at a memory address specified by MAddr. Data0 represents the data byte in memory location MAddr, Data1 represents the data from MAddr + 1, and DataN represents the last byte read by the master.

S SAddr W A MAddr A Sr SAddr R A Data0 A Data1 A ... DataN N P

Data is returned beginning with the MSb of the data in MAddr. Because the address is automatically incremented after the LSb of each byte is returned, the MSb of the data at address MAddr + 1 is available to the host immediately after the acknowledgement of the data at address MAddr. If the bus master continues to read beyond address FFh, the DS2777/DS2778 output data values of FFh. Addresses labeled reserved in the *Memory Map* return undefined data. The bus master terminates the read transaction at any byte boundary by issuing a not acknowledge followed by a STOP or repeated START.

### Function Command Protocol

The function command protocol executes a device-specific operation by writing one of the function command values (FCmd) to memory address FEh. Table 15 lists the DS2777/DS2778 FCmd values and describes the actions taken by each. A 1-byte write protocol is used to transmit the function command, with the MAddr set to FEh and the data byte set to the desired FCmd value. Additional data bytes are ignored. Data read from memory address FEh is undefined.

S SAddr W A MAddr = 0FEh A FCmd A P

# 2-Cell, Stand-Alone, Li+ Fuel-Gauge IC with Protector and Optional SHA-1 Authentication

Table 15. Function Commands

FUNCTION COMMAND	TARGET EEPROM BLOCK	FCmd VALUE	DESCRIPTION
Copy Data	0	42h	This command copies the shadow RAM to the target EEPROM block. Copy data commands that target locked blocks are ignored. While the Copy Data command is executing, the EEC bit in the EEPROM register is set to 1, and write data commands with MAddr set to any address within the target block are ignored. Read data and write data commands with MAddr set outside the target block are processed while the copy is in progress. The Copy Data command execution time, $t_{EEC}$ , is 2ms typical and starts after the FCmd byte is acknowledged. Subsequent copy or lock commands must be delayed until the EEPROM programming cycle completes.
	1	44h	
Recall Data	0	B2h	This command recalls the contents of the targeted EEPROM block to its shadow RAM.
	1	B4h	
Lock	0	63h	This command locks (write protects) the targeted EEPROM block. The LOCK bit in the EEPROM register must be set to 1 before the Lock command is executed. If the LOCK bit is 0, the Lock command has no effect. The Lock command is permanent; a locked block can never be written again. The Lock command execution time, $t_{EEC}$ , is 2ms typical and starts after the FCmd byte is acknowledged. Subsequent copy or lock commands must be delayed until the EEPROM programming cycle completes.
	1	66h	
Read ROM ID	—	39h	This command initiates a read of the unique 64-bit ROM ID. After the Read ROM ID command is sent, the ROM ID can be read with the following sequence: S SAddr R Data0 A Data1 A ... Data7 N P

## Selector Guide

PART	INTERFACE	SHA-1
DS2775G+	1-Wire	No
DS2775G+T&R	1-Wire	No
DS2776G+	1-Wire	Yes
DS2776G+T&R	1-Wire	Yes
DS2777G+	2-Wire	No
DS2777G+T&R	2-Wire	No
DS2778G+	2-Wire	Yes
DS2778G+T&R	2-Wire	Yes

+Denotes a lead(Pb)-free/RoHS-compliant package.  
T&R = Tape and reel.

## Package Information

For the latest package outline information and land patterns, go to [www.maxim-ic.com/packages](http://www.maxim-ic.com/packages). Note that a "+", "#", or "-" in the package code indicates RoHS status only. Package drawings may show a different suffix character, but the drawing pertains to the package regardless of RoHS status.

PACKAGE TYPE	PACKAGE CODE	DOCUMENT NO.
14 TDFN	T1435N+1	<a href="#">21-0253</a>

**DS2775/DS2776/DS2777/DS2778**

## 2-Cell, Stand-Alone, Li+ Fuel-Gauge IC with Protector and Optional SHA-1 Authentication

### Revision History

REVISION NUMBER	REVISION DATE	DESCRIPTION	PAGES CHANGED
0	10/08	Initial release.	—
1	3/09	Corrected values in the <i>VOV Register Programmability</i> table (Table 5).	27
2	7/09	Corrected the 2-wire slave address default value to 1011001.	42
3	5/10	Removed references to the OV, UV, COC, DOC, and POR flags in <i>Overvoltage (OV)</i> ; <i>Undervoltage (UV)</i> ; <i>Overcurrent, Charge Direction (COC)</i> ; <i>Overcurrent, Discharge Direction (DOC)</i> ; <i>Short Circuit (SC)</i> ; <i>Protection, Status, and Control Registers</i> ; and <i>Status Register Format</i> sections.	12, 14, 25, 26

DS2775/DS2776/DS2777/DS2778

Maxim cannot assume responsibility for use of any circuitry other than circuitry entirely embodied in a Maxim product. No circuit patent licenses are implied. Maxim reserves the right to change the circuitry and specifications without notice at any time.

46 **Maxim Integrated Products, 120 San Gabriel Drive, Sunnyvale, CA 94086 408-737-7600**