



AN1344 APPLICATION NOTE

VIpower: 108W POWER SUPPLY USING VIPer100A

John S. Lo Giudice

INTRODUCTION

The VIPer100A is designed to deliver 100W for the upper voltage range or 50W for universal input. This application note describes a power supply that delivers over 100W for both voltage ranges using a voltage doubler in the front end. The VIPer100A combines a state of the art PWM circuit together with an optimized 700V avalanche rugged Vertical Power MOSFET. It is part of STMicroelectronics proprietary VIpower, (Vertical Intelligent Power). It uses a fabrication process, which allows the integration of analog control circuits with vertical power device on the same chip.

Key Features of The VIPer100A

- Adjustable switching Frequency Up to 200KHz
- Current mode Control
- Burst Mode Operation in Stand-by Mode, Meets "Blue Angel"
- Undervoltage Lock-out with Hysteresis
- Integrated Start-up Supply
- Avalanche Rugged
- Over temperature Protection
- Primary or secondary Regulation

1. SCOPE

This document will cover the implementation and results for achieving 18V at 6A power supply that will run from both European and domestic mains. (90-132 Vac and 180- 264 Vac, 47-63 Hz).

Figure 1: Board layout

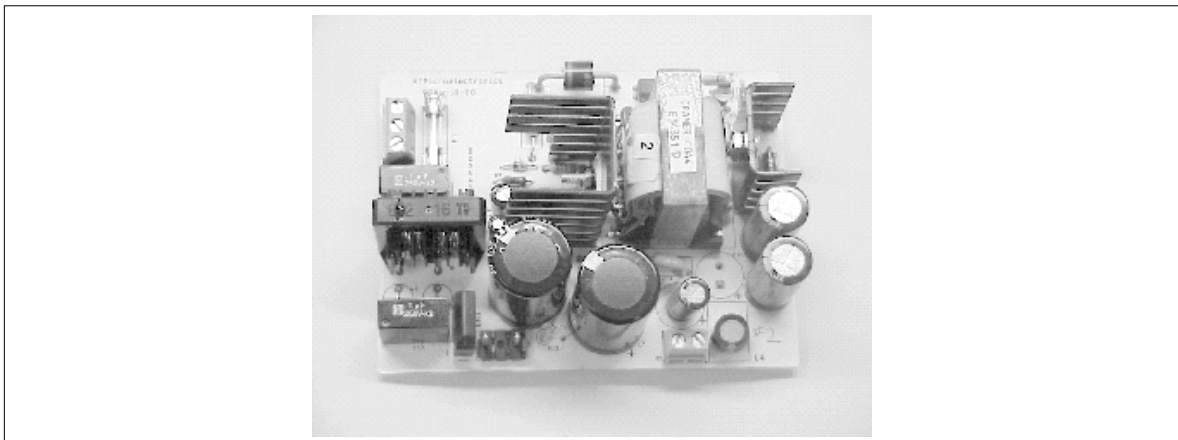

The power supply will have low ripple voltage, good transient response, and be able to current limit by power limiting and cycling on and off during a hard short. One reason for this application is an audio or entertainment system to replace a bulky 60Hz transformer with a lighter, better regulated, more efficient alternative.

2. GENERAL CIRCUIT DESCRIPTION

The power supply was designed for the upper voltage range. The lower voltage range utilizes a voltage doubler to raise the bulk voltage to 2 times the peak of the input line voltage. In the doubling mode, the current charges one capacitor for each phase of the line, therefore doubling the voltage. When SW1 is open, both capacitors are charged in series resulting in a bulk voltage equal to the peak of the line input. A wire jumper can be installed at production for units destined for countries using the lower range

The switching frequency operates at 100kHz. The output can deliver 18V from no load to 6A continuous. The mode of operation ranges from discontinuous at high line minimum load to continuous at low line max load. This mode of operation was chosen to minimize the high peak currents of the discontinuous mode of operation.

The VIPer100A can be regulated in secondary mode with an optocoupler giving excellent regulation or in the primary mode. Primary regulation works by regulating the Vdd pin at the output of the auxiliary winding. Depending on the coupling of the transformer, a 15% regulation can be achieved. In this application, by taking advantage of the dual regulation, a current limit scheme is accomplished. This VIPer100A advantage, along with the transformer design, constitutes the overcurrent circuit. The transformer is designed for a turn's ratio of operation for a universal input and an inductance to run in continuous conduction mode at one-half the output load. The coupling between the secondary to auxiliary winding along with the VIPer100A dual regulation plays an important part in the current limit. Under typical operation, the output is tightly regulated through U2 and U3, the optocoupler and TL431 respectively. As the output current increases, it causes the voltage at the auxiliary output to increase. R4 is selected to trim the voltage at Vdd to reach 13V when the output current is exceeding the maximum limit. At this point, primary regulation takes over and the output starts to fold-back.

The output uses an STMicroelectronics 100V Schottky diode for better efficiency. C9 and C10 are low ESR capacitor to manage the ripple current. U3 provides the reference and the feedback to tightly regulate the output. C7, C8, and R6 form the feed back loop compensation to optimize stability during transients.

Table 1: Electrical specification

Parameter	Results
Input voltage	90-132Vac with jumper in, 180 - 264 Vac no jumper
Output Voltage J2	18 V from 0 to 6A
Load Regulation (0.6 to 6A) from set point	+/- 0.6%
Line Regulation (At max load)	+/- 0.05%
Efficiency	86% @120Vdc and 87% @ 375Vdc
Output Ripple Voltage	15 mV Max
Input Power at No Load	1.5W typical
Transient Response, 50% load step	+/- 350 mV, +/- 1.9%, 200us settling time
EMI	EN55022 and FCC class B

AN1344 - APPLICATION NOTE

Figure 2: Electrical schematic

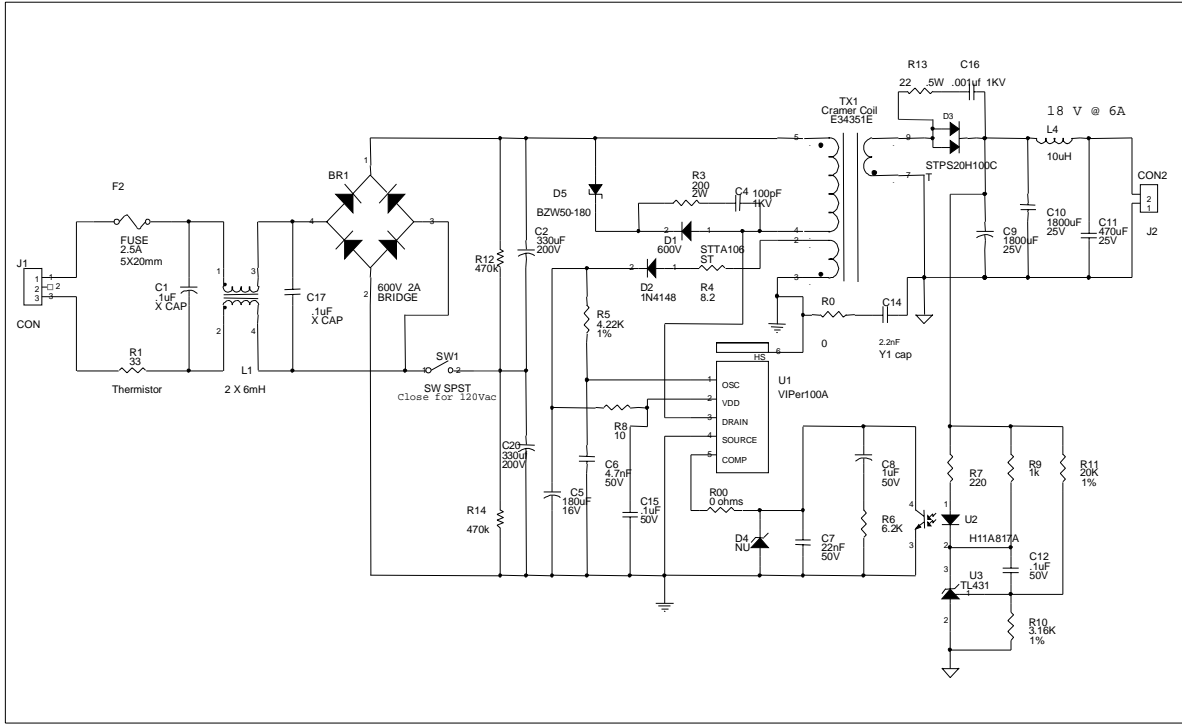

3. TRANSFORMER SPECIFICATION

Primary inductance	525uH
Primary leakage inductance	7.9 uH
Core	ETD34
Inductance rating (AI Factor)	329 nH/T
Note	Split Primary - Gapped Core

3.1 TRANSFORMER CONSTRUCTION

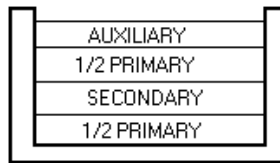

ETD34 PC40
Cramer Coil & Transformer
P# E34351e

The transformer is wound with a split primary to reduce leakage inductance and minimize the snubbing needed. The auxiliary winding is placed on the outside to achieve the coupling needed for the current limiting function.

Figure 3: Pc Board Top Legend And Bottom Foil (112mm X 83mm Single sided)

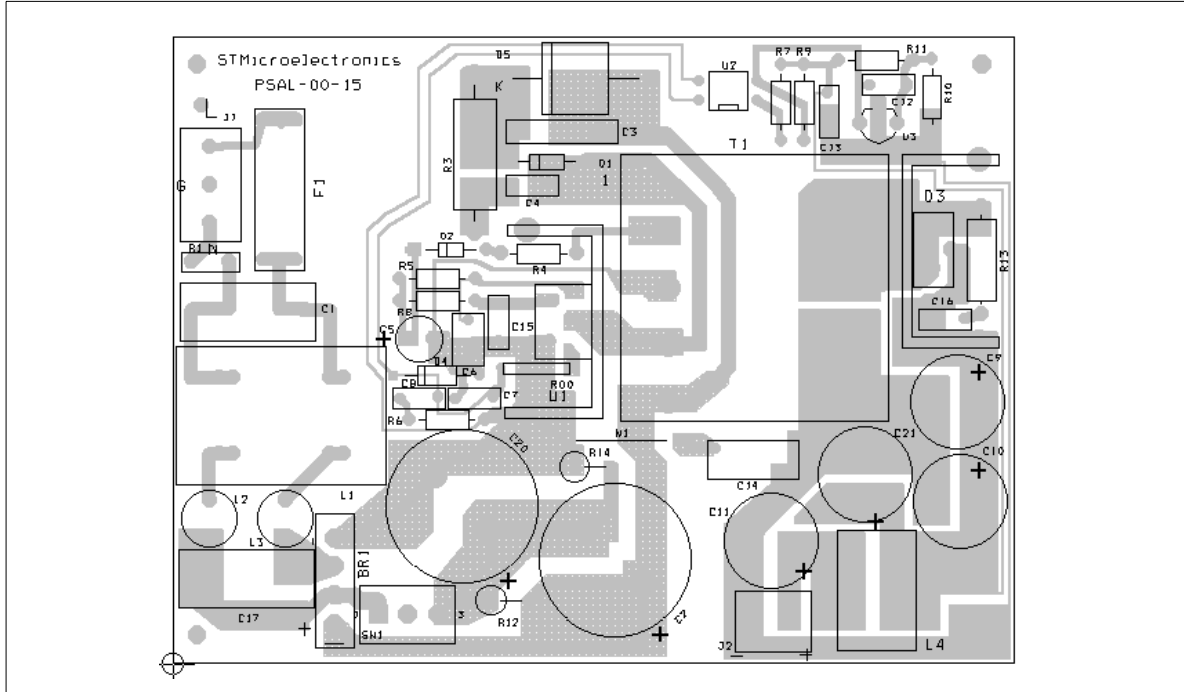

Figure 4: Voltage And Current Waveforms

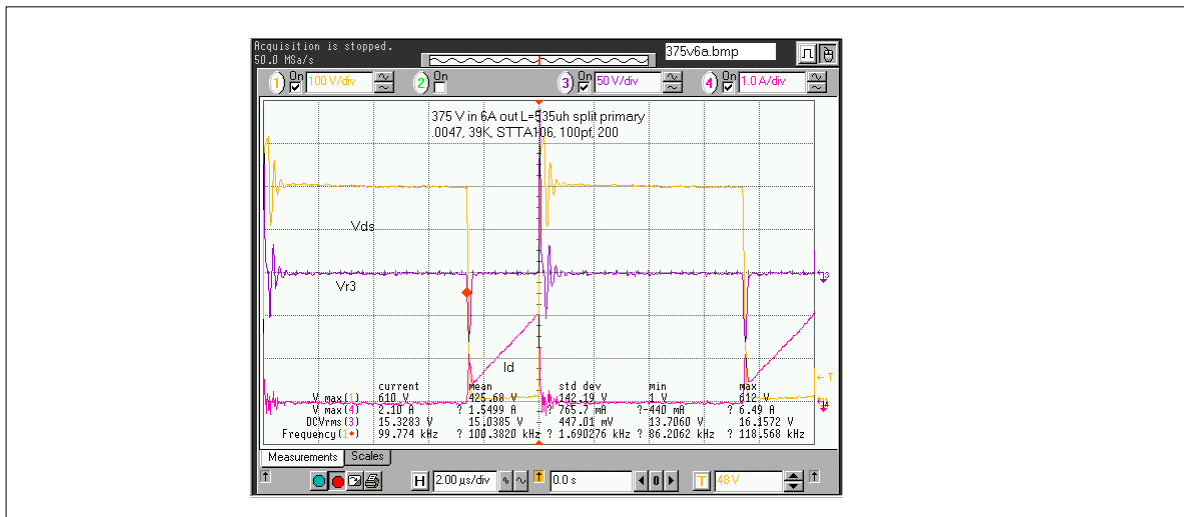

Figure 4 illustrates the voltage drain to source, and the current through the VIPer100A.

Vr3 is the Vrms across R3 to snub the diode. The maximum voltage drain to source measured 609V out of the 700V, specified maximum. The current shows the power supply being in the continuous conduction mode with a peak of 2A. The snubber R3-C4 reduces the ringing thus lowering the maximum peak voltage on the MOSFET and reducing the EMI. In these waveforms the transil, D3, was replaced by a RC

AN1344 - APPLICATION NOTE

clamp, (R2=39K, 2W and C3=4700pF). The clamp circuit worked the same under normal operation, but during start up or during short circuit operation, the voltage on the drain of VIPer100A reached as high as 750V. The device is avalanche rugged and was able to withstand the momentary energy. Using the Transil at this power level is preferred to reduce the stresses.

COMPONENT LIST

QUANTITY	REFERENCE	VALUE	PART NUMBER
1	BR1	600V, 1.5A	BRIDGE 2KBP06M
2	C1, C17	0.1μF, X CAP	P4610
2	C2, C20	330μF, 200V	P6116
1	C4	100pF, 1KV	P4116
1	C5	180μF, 16V	P10245
1	C6	4.7nF, 50V	P4793
1	C7	22nF, 50V	P4517
1	C8	1μF, 50V	P10312
1	C9	1800μF, 25V	PANASONIC FC
1	C10	1800μF, 25V	P10283
1	C11	470μF, 25V	P6242C
2	C12, C15	0.1μF, 50V	P4923
1	C14	2.2nF, Y1 CAP	P10463
1	C16	0.001μF, 1KV	P4128
1	D1	600V	STMicroelectronics STTA106
1	D2		1N4148
1	D3	2x10A, 100V	STMicroelectronics STPS20H100CT
1	D4	3.3NZ	NU
1	D5		STMicroelectronics BZW50-180
1	F2	2.5A, 5x20mm	FUSE
1	J1		CON
1	J2		CON2
1	L1	2x6mH	PLK1084
1	L4	10μH	M6007
1	R0	0	WIRE
1	R00	0Ω	WIRE
1	R1	33Ω Thermistor	NW 96F3302
1	R3	200Ω, 2W	
1	R4	8.2Ω	
1	R5	4.22KΩ, 1%	
1	R6	6.2KΩ	
1	R7	220Ω	
1	R8	10Ω	
1	R9	1KΩ	
1	R10	3.16KΩ, 1%	
1	R11	20KΩ, 1%	
2	R12, R14	470KΩ, 1/4W	
1	R13	22Ω, 1/2W	
1	SW1		SW SPST
1	TX1	Cramer Coil	E34351E
1	U1	VIPer100A	STMicroelectronics VIPer100A
1	U2		H11A817A
1	U3	TL431	STMicroelectronics TL431Z

4. LAYOUT CONSIDERATIONS

Some simple rules to improve the performance and minimize noise should be followed:

1) minimize power loops. Switched power current paths inner loop area must be as small as possible. This can be accomplished by careful layout of the printed circuit board. This avoids radiated and conducted EMI noise, and improves the efficiency by eliminating parasitic inductance, thus reducing or eliminating the need for snubbers and EMI filtering.

2) use separate tracks for low level signal and power traces carrying fast switching pulses. This can be seen on the VIPer100A pin 4. Ground is split between power and signal traces on the printed circuit layout. When signal paths are sharing the same trace as a power path, instabilities may result. The compensation components, C7, R6, and C9 are on a separate trace connected directly to the source of the device.

5. BURST MODE

When the output current is too low, the minimum on time, fixed by the internal blanking time, is too high to control the output voltage. In this case the burst mode operation takes over automatically. The VIPer100A switch stays off when the voltage on the compensation pin goes below 0.5V. This results in missing cycles as shown in figure 5. Vin is 115 Vac, minimum output current is at 40mA.

Figure 5: Good Burst Mode

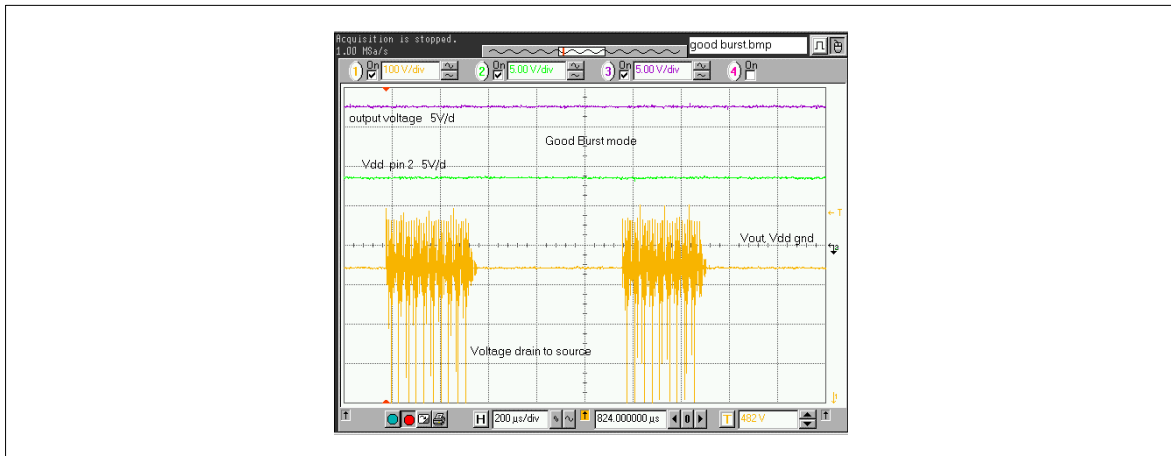

As can be seen, there is a burst of pulses followed by a pause of 600µs. This repetitive burst reduces power consumption while maintaining a negligible ripple on the output. The Vdd voltage is stable, just above the low threshold of 8V of the internal under voltage lock out. The under voltage lock out can be reached by further reducing the output current. As the current decreases, the Vdd voltage on the primary side also decreases. When Vdd reaches below the under voltage lock out of 8V, another type of burst mode appears which is controlled by the Vdd voltage. This is called the Bad burst mode (see figure 6). Bad because it has drawbacks, but the output voltage is still under control.

AN1344 - APPLICATION NOTE

Figure 6: Bad Burst Mode

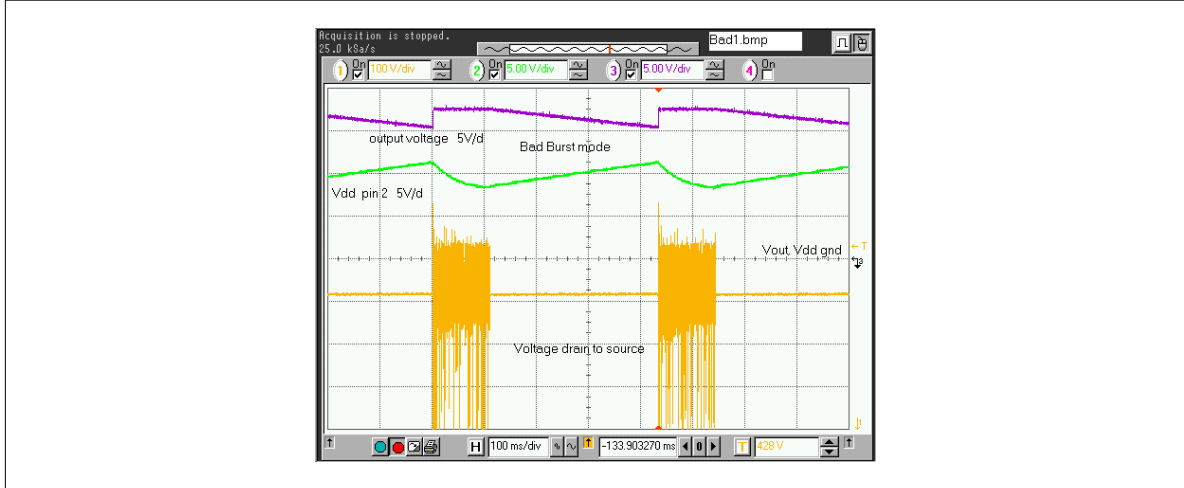

At Lighter load, the Vdd voltage droops below the under voltage threshold, the start up circuit is reset, and the Vdd capacitor charges back up to the high threshold of 11V through the start up current source. As shown in the picture the reoccurrence of this cycle is about 300ms. The worse output voltage swing is 2.4V, which occurs at 20mA. At no load condition, the output voltage swing becomes negligible (45mV). This mode of operation leads to the following drawbacks:

- 1) Because the start up current source is turned on to supply the capacitor from a high voltage rail, the efficiency is dramatically reduced.
- 2) The recurring period leads to as much as 13% variation on the output voltage. For this audio application it does not matter, but the designer should review all aspects of operation.
- 3) Below the minimum current of 40mA, the dynamic behavior is very poor which is typical of all power supplies. If the demand of current occurs during the recharging phase, the output capacitor will be discharged and normal operation will return only at the next starting phase.

In conclusion for this design a 40mA minimum load is needed, 0.6% of maximum load, to keep the unit in optimal performance. However, below this range, the output voltage is still under control and no stresses are applied to the unit.

STAND-BY INPUT POWER

Input Voltage	Input Wattage at No Load	Input Wattage at 40 mA
90 Vac	0.85 W	1.77 W
115 Vac	1.1 W	1.8 W
132 Vac	1.3 W	1.86 W

The transformer was optimized for the current scheme and not for Blue Angel.

6. THERMAL CONSIDERATION

Temperature measurement was taken at room ambient of 24°C, convection air-cooled resulted in the VIPer100A tab temperature of 91.1°C at 115 Vac input with a 6A output. Results may vary depending on final application.

7. OVERCURRENT LIMITING

This power supply was designed for an audio application where music peaks can exceed the maximum current of the power supply. In a sound entertainment system it is imperative for the power supply not to shut down during such peaks. It is acceptable for the voltage to decrease as the current increases. This maintains a constant power for the unit. Under a short circuit condition, this unit will cycle on and off or "hiccup mode". In figure 7 the output voltage versus the output current is shown. Maximum output power reached is 163W. The VIPer100A also has thermal shutdown with hysteresis that is located close to the MOSFET portion of the die, which will protect it from exceeding the temperature limit of the I.C.

Figure 7: Output voltage versus the output current

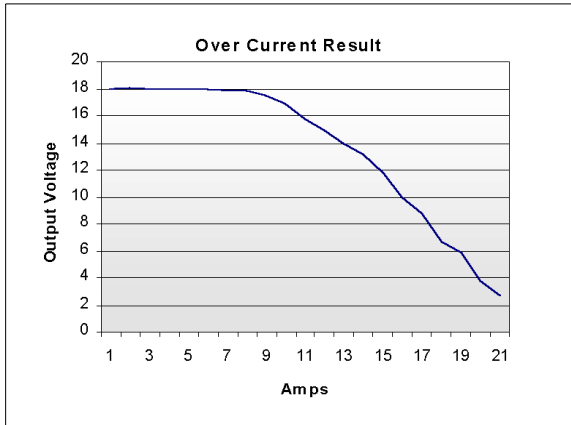

Figure 8: Transient Response 50% Step Change



Figure 9: Output Ripple

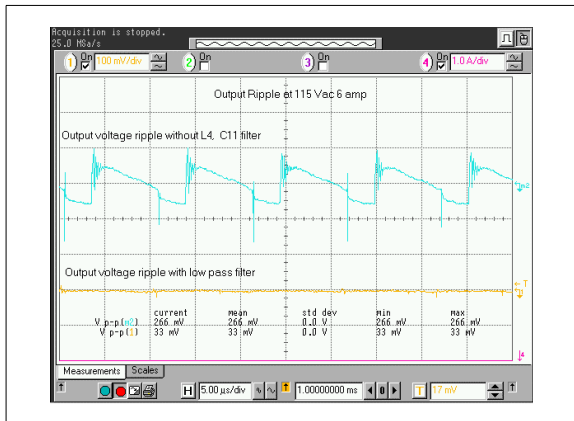
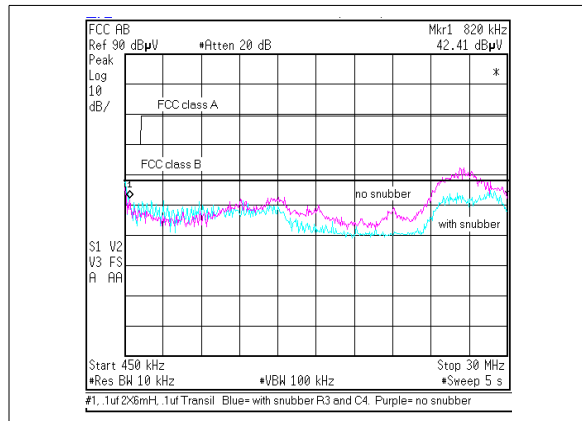

Figure 10: EMI Measurement



AN1344 - APPLICATION NOTE

8. TRANSIENT RESPONSE 50% STEP CHANGE

The output current is modulated from 3A to 6A, 50% duty cycle at a line input of 115Vac. The result is 322mV or 1.8% dynamic regulation with a settling time of 500 microseconds

9. OUTPUT RIPPLE

The ripple was measured using a HP probe socket attached after the output connector. This minimizes stray noise being picked up by the scope probe ground lead, which shows up as high frequency noise.

The top trace shows the cost reduced result from eliminating L4 and C11. This gives a ripple, at 6A load, of 125mV peak to peak. With the low pass filter the ripple is reduced to about 13mV excluding voltage spikes.

10. EMI CONSIDERATION

When dealing with EMI, it is always best to reduce noise at its source. Figure 10 shows FCC class B plots comparing EMI at 6 amps load with snubber R3 and C4 in and out. The blue trace, or lower trace, has the RC snubber across the diode. The EMI is reduced by 4 to 8 db. Adding a 2W resistor and a capacitor here is much less expensive than adding across the line capacitors and inductors in the EMI filter. This unit passed both EN55022 class B and FCC class B.

11. PERFORMANCE AND COST CONSIDERATION

This design has been optimized for performance. Cost trade off can be accomplished by substituting a 17V zener for the TL431. The output regulation will degrade to the +/- 5% voltage set point, plus a +0.084/°C temperature drift of the zener. The cost of the TL431 and 3 other passive components can than be eliminated. If more output ripple voltage can be tolerated, than L4 and C11 can be eliminated.

12. CONCLUSION

This design delivers over 100W for both voltage ranges by utilizing the VIPer100A with a voltage doubler in the front end. The power supply has excellent regulation, current limiting, short circuit protection, meets both EN55022 and FCC class B and best of all its from STMicroelectronics.

AN1344 - APPLICATION NOTE

Information furnished is believed to be accurate and reliable. However, STMicroelectronics assumes no responsibility for the consequences of use of such information nor for any infringement of patents or other rights of third parties which may result from its use. No license is granted by implication or otherwise under any patent or patent rights of STMicroelectronics. Specifications mentioned in this publication are subject to change without notice. This publication supersedes and replaces all information previously supplied. STMicroelectronics products are not authorized for use as critical components in life support devices or systems without express written approval of STMicroelectronics.

The ST logo is a registered trademark of STMicroelectronics

© 2001 STMicroelectronics - Printed in ITALY- All Rights Reserved.

STMicroelectronics GROUP OF COMPANIES

Australia - Brazil - China - Finland - France - Germany - Hong Kong - India - Italy - Japan - Malaysia - Malta - Morocco -
Singapore - Spain - Sweden - Switzerland - United Kingdom - U.S.A.

<http://www.st.com>