

384-OUTPUT TFT-LCD SOURCE DRIVER (COMPATIBLE WITH 64-GRAY SCALES)

DESCRIPTION

The μ PD160061A is a source driver for TFT-LCDs capable of dealing with displays with 64-gray scales. Data input is based on digital input configured as 6 bits by 6 dots (2 pixels), which can realize a full-color display of 260,000 colors by output of 64 values γ -corrected by an internal D/A converter and 5-by-2 external power modules. Because the output dynamic range is as large as $V_{SS2} + 0.2$ V to $V_{DD2} - 0.2$ V, level inversion operation of the LCD's common electrode is rendered unnecessary. Also, to be able to deal with dot-line inversion, n-line inversion and column line inversion when mounted on a single side, this source driver is equipped with a built-in 6-bit D/A converter circuit whose odd output pins and even output pins respectively output gray scale voltages of differing polarity. Assuring a maximum clock frequency of 65 MHz when driving at 2.7 V, this driver is applicable to XGA-standard TFT-LCD panels and SXGA TFT-LCD panels.

FEATURES

- CMOS level input (2.3 to 3.6 V)
- 384 outputs
- Input of 6 bits (gray-scale data) by 6 dots
- Capable of outputting 64 values by means of 5-by-2 external power modules (10 units) and a D/A converter (R-DAC)
- Logic power supply voltage (V_{DD1}): 2.3 to 3.6 V
- Driver power supply voltage (V_{DD2}): 7.5 to 9.5 V
- High-speed data transfer: $f_{CLK} = 65$ MHz MAX. (internal data transfer speed when operating at $V_{DD1} = 2.7$ V)
40 MHz MAX. (internal data transfer speed when operating at $V_{DD1} = 2.3$ V)
- Output dynamic range: $V_{SS2} + 0.2$ V to $V_{DD2} - 0.2$ V
- Apply for dot-line inversion, n-line inversion and column line inversion
- Output voltage polarity inversion function (POL)
- Input data inversion function (capable of controlling by each input port) (POL21, POL22)
- Apply for heavy load, light load
- Semi slim-chip shaped

ORDERING INFORMATION

Part Number	Package
μ PD160061AN-xxx	TCP (TAB package)
μ PD160061ANL-xxx	COF (COF package)

Remark The TCP's external shape is customized. To order the required shape, so please contact one of our sales representatives.

The information in this document is subject to change without notice. Before using this document, please confirm that this is the latest version.
Not all products and/or types are available in every country. Please check with an NEC Electronics sales representative for availability and additional information.

1. BLOCK DIAGRAM

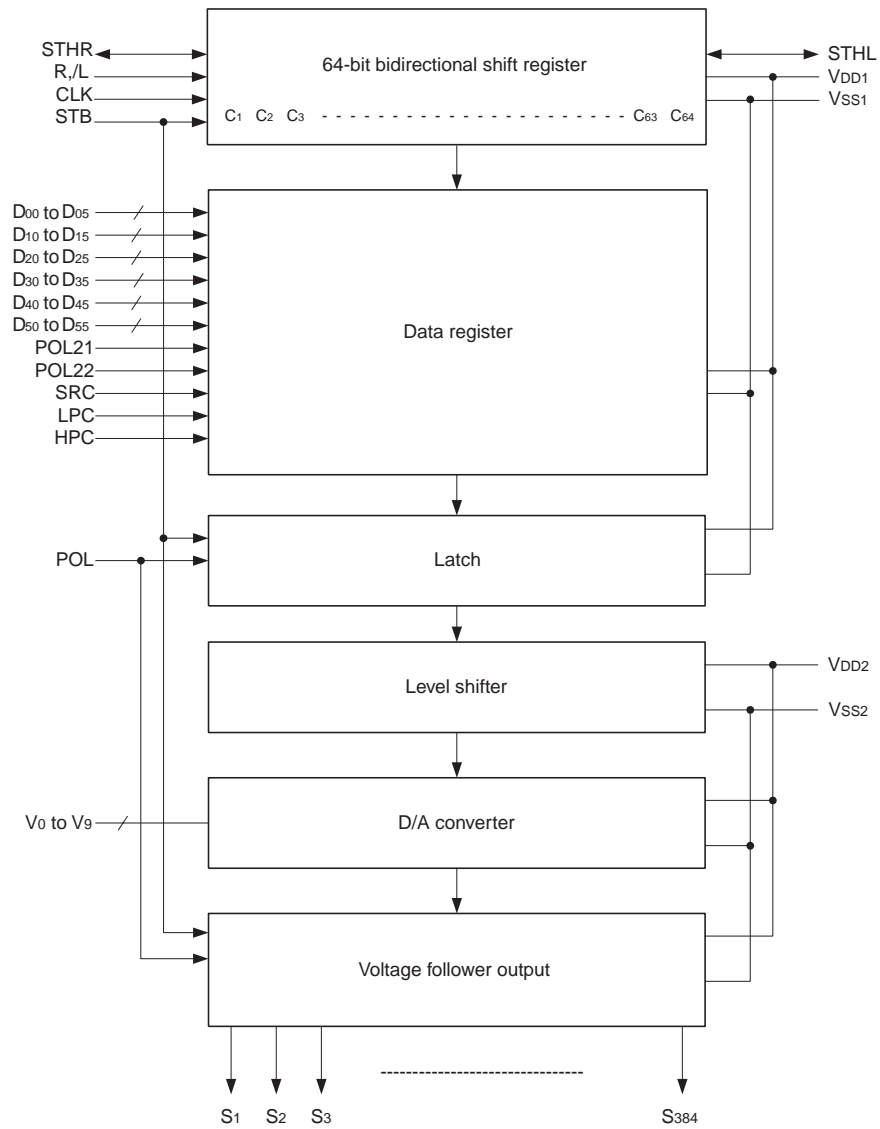

Remark /xxx indicates active low signal.

2. RELATIONSHIP BETWEEN OUTPUT CIRCUIT AND D/A CONVERTER

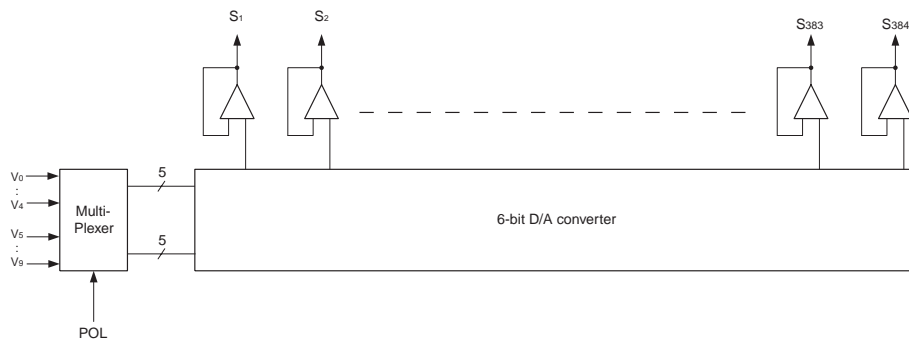

3. PIN CONFIGURATION (Copper foil surface: Face-up)

(μPD160061AN-xxx: TCP (TAB package) / μPD160061ANL-xxx: COF (COF package))

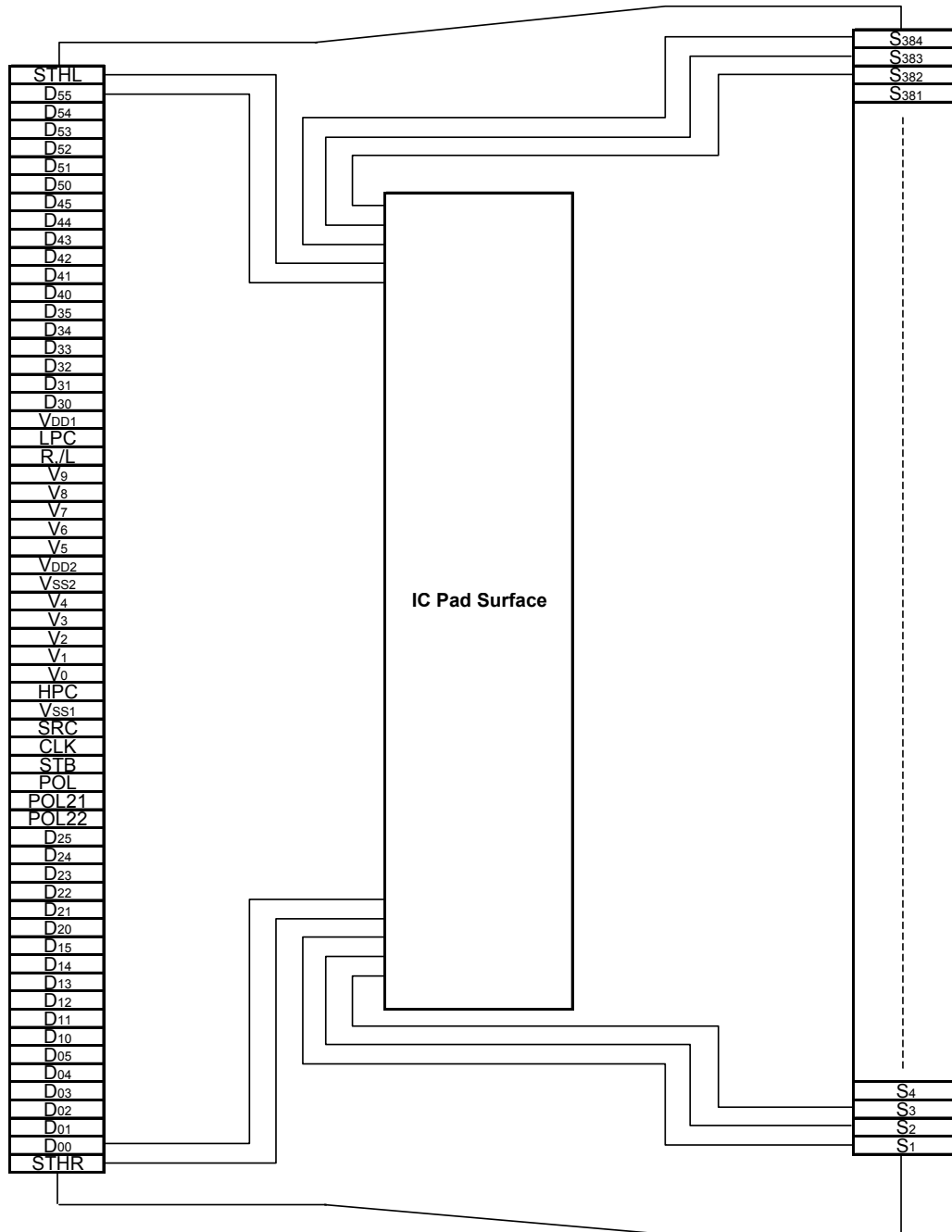

Remark This figure does not specify the TCP or COF package.

4. PIN FUNCTIONS

(1/2)

Pin Symbol	Pin Name	I/O	Description
S ₁ to S ₃₈₄	Driver output	Output	The D/A converted 64-gray-scale analog voltage is output.
D ₀₀ to D ₀₅	Display data input	Input	The display data is input with a width of 36 bits, viz., the gray scale data (6 bits) by 6 dots (2 pixels). D _{x0} : LSB, D _{x5} : MSB
D ₁₀ to D ₁₅			
D ₂₀ to D ₂₅			
D ₃₀ to D ₃₅			
D ₄₀ to D ₄₅			
D ₅₀ to D ₅₅			
R,/L	Shift direction control	Input	These refer to the start pulse I/O pins when driver ICs are connected in cascade. Fetching of display data starts when H is read at the rising edge of CLK. R,/L = H (right shift): STHR input, S ₁ →S ₃₈₄ , STHL output R,/L = L (left shift): STHL input, S ₃₈₄ →S ₁ , STHR output
STHR	Right shift start pulse input/output	I/O	These refer to the start pulse I/O pins when driver ICs are connected in cascade. Fetching of display data starts when H is read at the rising edge of CLK. When right shift: STHR input, STHL output When left shift: STHL input, STHR output A high level should be input as the pulse of one cycle of the clock signal. If the start pulse input is more than 2CLK, the first 1CLK of the high-level input is valid.
STHL	Left shift start pulse input/output		
CLK	Shift clock input	Input	Refers to the shift register's shift clock input. The display data is incorporated into the data register at the rising edge. At the rising edge of the 64th after the start pulse input, the start pulse output reaches the high level, thus becoming the start pulse of the next-level driver. If 66th clock pulses are input after input of the start pulse, input of display data is halted automatically. The contents of the shift register are cleared at the STB's rising edge.
STB	Latch input	Input	The contents of the data register are transferred to the latch circuit at the rising edge. And, at the falling edge of the STB, the gray scale voltage is supplied to the driver. When STB = H period, driver output level is Hi-Z (High impedance). It is necessary to ensure input of one pulse per horizontal period.
POL	Polarity input	Input	POL = L: The S _{2n-1} output uses V ₀ to V ₄ as the reference supply. The S _{2n} output uses V ₅ to V ₉ as the reference supply. POL = H: The S _{2n-1} output uses V ₅ to V ₉ as the reference supply. The S _{2n} output uses V ₀ to V ₄ as the reference supply. S _{2n-1} indicates the odd output, and S _{2n} indicates the even output. Input of the POL signal is allowed the setup time (t _{POL-STB}) with respect to STB's rising edge.
POL21, POL22	Data inversion input	Input	Data inversion can invert when display data is loaded. POL21: D ₀₀ to D ₀₅ , D ₁₀ to D ₁₅ , D ₂₀ to D ₂₅ , data inversion can invert display data POL22: D ₃₀ to D ₃₅ , D ₄₀ to D ₄₅ , D ₅₀ to D ₅₅ , data inversion can invert display data POL21, POL22 = H: Data inversion loads display data after inverting it. POL21, POL22 = L: Data inversion does not invert input data.
LPC, HPC	Bias current control input	Input	Please refer to panel loads and driver power supply voltage (V _{DD2}), when set up these pins. Refer to 10. BIAS CURRENT CONTROL BY LPC AND HPC . LPC pin is pulled down to the V _{SS1} inside the IC, HPC pin is pulled up to the V _{DD1} inside the IC.

Pin Symbol	Pin Name	I/O	Description
SRC	High driving time control	Input	This pin is set up to high drive time of the output amplifier. Please decide the pin setting refer to panel loads and one horizontal period. SRC pin is pulled up to the V _{DD1} inside the IC. SRC = H or open: High drive time 64 CLK (Normally period mode) SRC = L: High drive time 128 CLK (Long time mode) Refer to 9. SRC AND HIGH DRIVE TIME.
V ₀ to V ₉	γ-corrected power supplies	–	Input the γ-corrected power supplies from outside by using operational amplifier. Make sure to maintain the following relationships. During the gray scale voltage output, be sure to keep the gray scale level power supply at a constant level. $V_{DD2} - 0.2 V \geq V_0 > V_1 > V_2 > V_3 > V_4 \geq 0.5 V_{DD2}$ $V_{DD2} - 0.3 V \geq V_5 > V_6 > V_7 > V_8 > V_9 \geq V_{SS2} + 0.2 V$
V _{DD1}	Logic power supply	–	2.3 to 3.6 V
V _{DD2}	Driver power supply	–	7.5 to 9.5 V
V _{SS1}	Logic ground	–	Grounding
V _{SS2}	Driver ground	–	Grounding

- Cautions**
- The power start sequence must be V_{DD1}, logic input, and V_{DD2} & V₀ to V₉ in that order.
Reverse this sequence to shut down.
 - To stabilize the supply voltage, please be sure to insert a 0.1 μF bypass capacitor between V_{DD1} to V_{SS1} and V_{DD2} to V_{SS2}. Furthermore, for increased precision of the D/A converter, insertion of a bypass capacitor of about 0.01 μF is also recommended between the γ-corrected power supply terminals (V₀, V₁, V₂,..., V₉) and V_{SS}.

5. RELATIONSHIP BETWEEN INPUT DATA AND OUTPUT VOLTAGE VALUE

The μPD160061A incorporates a 6-bit D/A converter whose odd output pins and even output pins output respectively gray scale voltages of differing polarity with respect to the LCD's counter electrode voltage. The D/A converter consists of ladder resistors and switches.

The ladder resistors (r0 to r62) are designed so that the ratio of LCD panel γ-compensated voltages to V_{0'} to V_{63'} and V_{0''} to V_{63''} is almost equivalent, resistor ratio is shown in Figure 5-2. For the 2 sets of five γ-compensated power supplies, V₀ to V₄ and V₅ to V₉, respectively, input gray scale voltages of the same polarity with respect to the common voltage. When fine-gray scale voltage precision is not necessary, there is no need to connect a voltage follower circuit to the γ-compensated power supplies V₁ to V₃ and V₆ to V₈.

Figure 5-1 shows the relationship between the driving voltages such as liquid-crystal driving voltages V_{DD2} and V_{SS2}, common electrode potential V_{COM}, and γ-corrected voltages V₀ to V₉ and the input data. Be sure to maintain the voltage relationships of below.

$$V_{DD2} - 0.2 V \geq V_0 > V_1 > V_2 > V_3 > V_4 \geq 0.5 V_{DD2}$$

$$0.5 V_{DD2} - 0.3 V \geq V_5 > V_6 > V_7 > V_8 > V_9 > V_{SS2} + 0.2 V$$

Figures 5-2 indicates γ-corrected voltages and ladder resistors ratio. Figures 5-3 indicates the relationship between the input data and output voltage.

Figure 5-1. Relationship between Input Data and γ-corrected Power Supplies

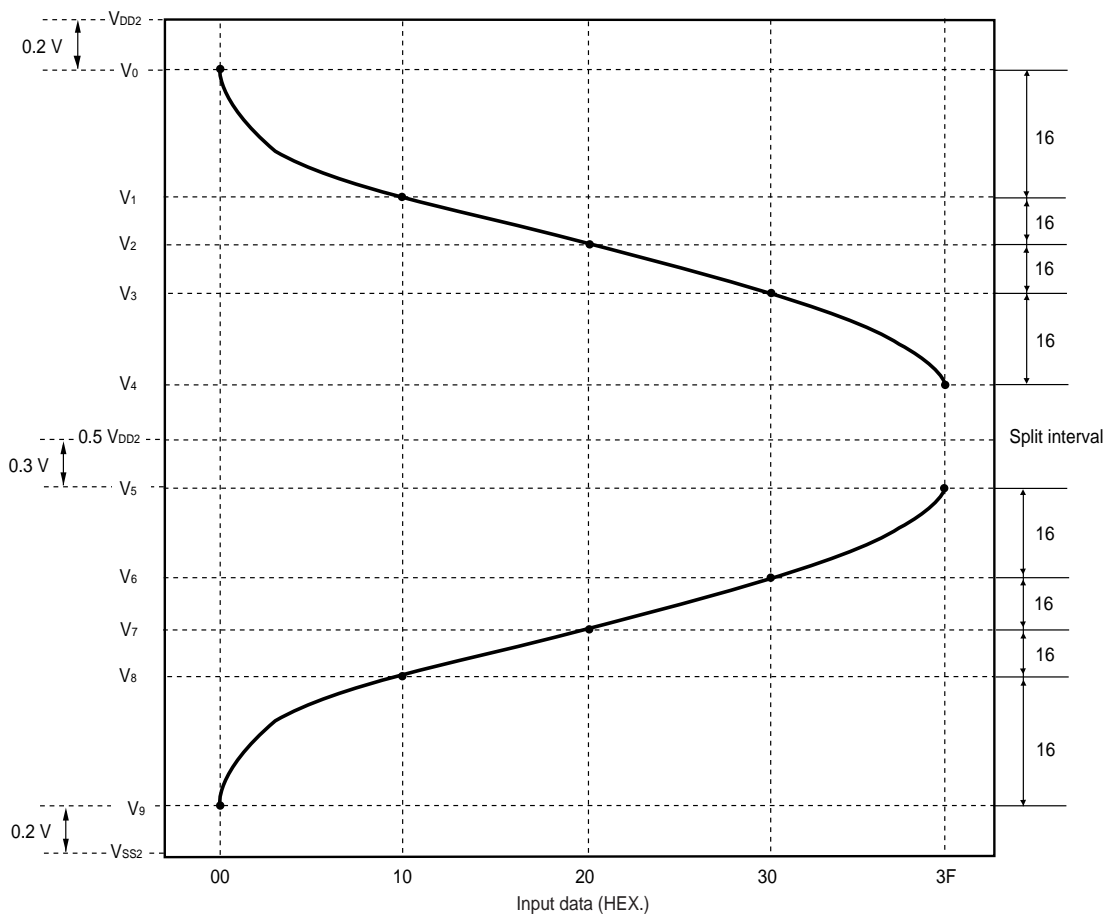
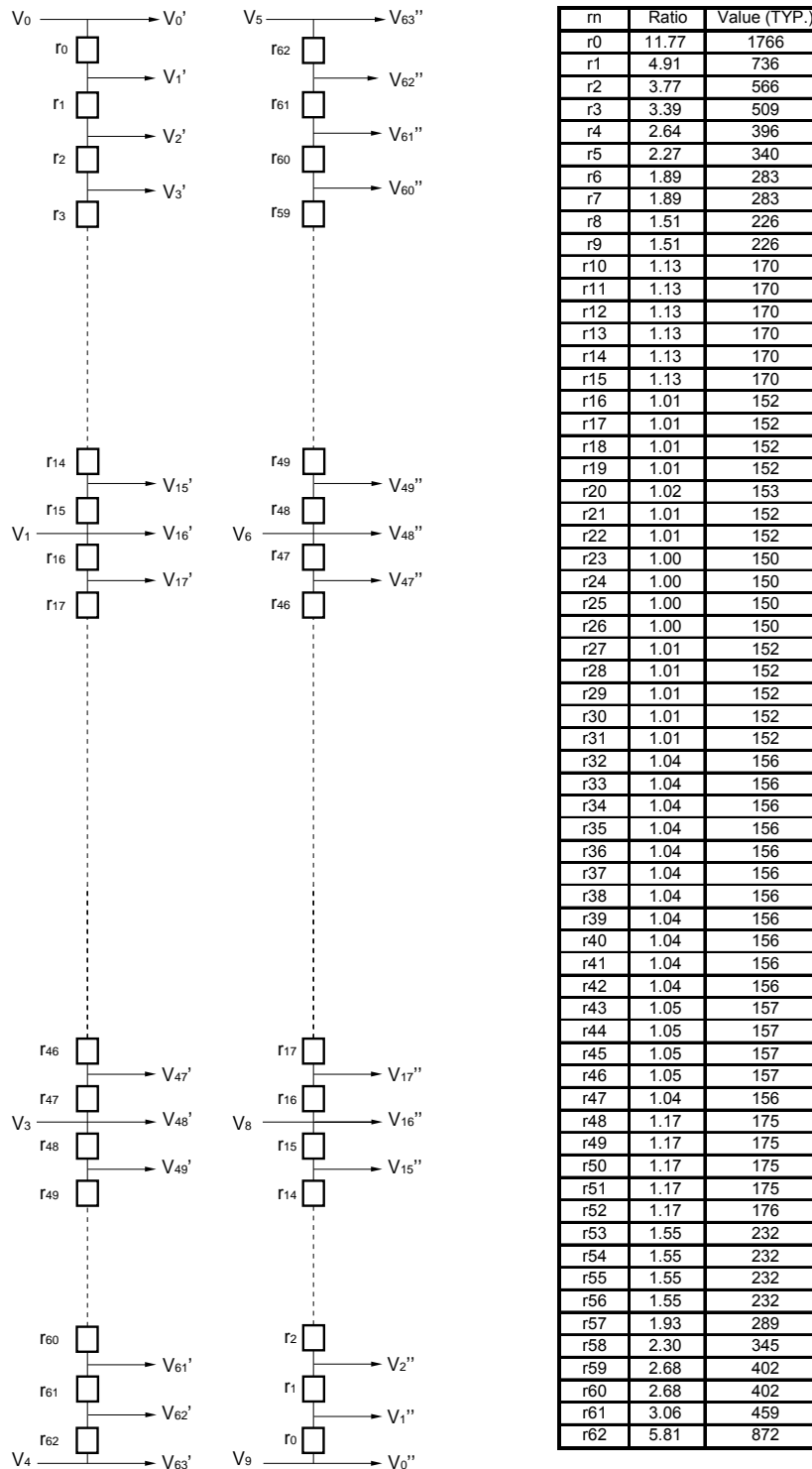

Figure 5-2. γ -corrected Voltages and Ladder Resistors Ratio



- Cautions1. There is no connection between V4 and V5 terminal in the IC.
- 2. The resistance ratio is a relative ratio in the case of setting the resistance minimum value to 1.

Figure 5-3. Relationship between Input Data and Output Voltage (POL21, POL22 = L)

Output Voltage 1: $V_{DD2} - 0.2 V \geq V_0 > V_1 > V_2 > V_3 > V_4 \geq 0.5 V_{DD2}$

Output Voltage 2: $0.5 V_{DD2} - 0.3 V \geq V_5 > V_6 > V_7 > V_8 > V_9 \geq V_{SS2} + 0.2 V$

Input	Output Voltage 1				Output Voltage 2			
	V ₀ '	V ₀			V ₀ '	V ₉		
00H	V ₀ '	V ₀			V ₀ '	V ₉		
01H	V ₁ '	V ₁ +(V ₀ -V ₁)×	4585 /	6351	V ₁ '	V ₉ +(V ₈ -V ₉)×	1766 /	6351
02H	V ₂ '	V ₁ +(V ₀ -V ₁)×	3849 /	6351	V ₂ '	V ₉ +(V ₈ -V ₉)×	2502 /	6351
03H	V ₃ '	V ₁ +(V ₀ -V ₁)×	3283 /	6351	V ₃ '	V ₉ +(V ₈ -V ₉)×	3068 /	6351
04H	V ₄ '	V ₁ +(V ₀ -V ₁)×	2774 /	6351	V ₄ '	V ₉ +(V ₈ -V ₉)×	3577 /	6351
05H	V ₅ '	V ₁ +(V ₀ -V ₁)×	2378 /	6351	V ₅ '	V ₉ +(V ₈ -V ₉)×	3973 /	6351
06H	V ₆ '	V ₁ +(V ₀ -V ₁)×	2038 /	6351	V ₆ '	V ₉ +(V ₈ -V ₉)×	4313 /	6351
07H	V ₇ '	V ₁ +(V ₀ -V ₁)×	1755 /	6351	V ₇ '	V ₉ +(V ₈ -V ₉)×	4596 /	6351
08H	V ₈ '	V ₁ +(V ₀ -V ₁)×	1472 /	6351	V ₈ '	V ₉ +(V ₈ -V ₉)×	4879 /	6351
09H	V ₉ '	V ₁ +(V ₀ -V ₁)×	1246 /	6351	V ₉ '	V ₉ +(V ₈ -V ₉)×	5105 /	6351
0AH	V ₁₀ '	V ₁ +(V ₀ -V ₁)×	1020 /	6351	V ₁₀ '	V ₉ +(V ₈ -V ₉)×	5331 /	6351
0BH	V ₁₁ '	V ₁ +(V ₀ -V ₁)×	850 /	6351	V ₁₁ '	V ₉ +(V ₈ -V ₉)×	5501 /	6351
0CH	V ₁₂ '	V ₁ +(V ₀ -V ₁)×	680 /	6351	V ₁₂ '	V ₉ +(V ₈ -V ₉)×	5671 /	6351
0DH	V ₁₃ '	V ₁ +(V ₀ -V ₁)×	510 /	6351	V ₁₃ '	V ₉ +(V ₈ -V ₉)×	5841 /	6351
0EH	V ₁₄ '	V ₁ +(V ₀ -V ₁)×	340 /	6351	V ₁₄ '	V ₉ +(V ₈ -V ₉)×	6011 /	6351
0FH	V ₁₅ '	V ₁ +(V ₀ -V ₁)×	170 /	6351	V ₁₅ '	V ₉ +(V ₈ -V ₉)×	6181 /	6351
10H	V ₁₆ '	V ₁			V ₁₆ '	V ₈		
11H	V ₁₇ '	V ₂ +(V ₁ -V ₂)×	2273 /	2425	V ₁₇ '	V ₈ +(V ₇ -V ₈)×	152 /	2425
12H	V ₁₈ '	V ₂ +(V ₁ -V ₂)×	2121 /	2425	V ₁₈ '	V ₈ +(V ₇ -V ₈)×	304 /	2425
13H	V ₁₉ '	V ₂ +(V ₁ -V ₂)×	1969 /	2425	V ₁₉ '	V ₈ +(V ₇ -V ₈)×	456 /	2425
14H	V ₂₀ '	V ₂ +(V ₁ -V ₂)×	1817 /	2425	V ₂₀ '	V ₈ +(V ₇ -V ₈)×	608 /	2425
15H	V ₂₁ '	V ₂ +(V ₁ -V ₂)×	1664 /	2425	V ₂₁ '	V ₈ +(V ₇ -V ₈)×	761 /	2425
16H	V ₂₂ '	V ₂ +(V ₁ -V ₂)×	1512 /	2425	V ₂₂ '	V ₈ +(V ₇ -V ₈)×	913 /	2425
17H	V ₂₃ '	V ₂ +(V ₁ -V ₂)×	1360 /	2425	V ₂₃ '	V ₈ +(V ₇ -V ₈)×	1065 /	2425
18H	V ₂₄ '	V ₂ +(V ₁ -V ₂)×	1210 /	2425	V ₂₄ '	V ₈ +(V ₇ -V ₈)×	1215 /	2425
19H	V ₂₅ '	V ₂ +(V ₁ -V ₂)×	1060 /	2425	V ₂₅ '	V ₈ +(V ₇ -V ₈)×	1365 /	2425
1AH	V ₂₆ '	V ₂ +(V ₁ -V ₂)×	910 /	2425	V ₂₆ '	V ₈ +(V ₇ -V ₈)×	1515 /	2425
1BH	V ₂₇ '	V ₂ +(V ₁ -V ₂)×	760 /	2425	V ₂₇ '	V ₈ +(V ₇ -V ₈)×	1665 /	2425
1CH	V ₂₈ '	V ₂ +(V ₁ -V ₂)×	608 /	2425	V ₂₈ '	V ₈ +(V ₇ -V ₈)×	1817 /	2425
1DH	V ₂₉ '	V ₂ +(V ₁ -V ₂)×	456 /	2425	V ₂₉ '	V ₈ +(V ₇ -V ₈)×	1969 /	2425
1EH	V ₃₀ '	V ₂ +(V ₁ -V ₂)×	304 /	2425	V ₃₀ '	V ₈ +(V ₇ -V ₈)×	2121 /	2425
1FH	V ₃₁ '	V ₂ +(V ₁ -V ₂)×	152 /	2425	V ₃₁ '	V ₈ +(V ₇ -V ₈)×	2273 /	2425
20H	V ₃₂ '	V ₂			V ₃₂ '	V ₇		
21H	V ₃₃ '	V ₃ +(V ₂ -V ₃)×	2344 /	2500	V ₃₃ '	V ₇ +(V ₆ -V ₇)×	156 /	2500
22H	V ₃₄ '	V ₃ +(V ₂ -V ₃)×	2188 /	2500	V ₃₄ '	V ₇ +(V ₆ -V ₇)×	312 /	2500
23H	V ₃₅ '	V ₃ +(V ₂ -V ₃)×	2032 /	2500	V ₃₅ '	V ₇ +(V ₆ -V ₇)×	468 /	2500
24H	V ₃₆ '	V ₃ +(V ₂ -V ₃)×	1876 /	2500	V ₃₆ '	V ₇ +(V ₆ -V ₇)×	624 /	2500
25H	V ₃₇ '	V ₃ +(V ₂ -V ₃)×	1720 /	2500	V ₃₇ '	V ₇ +(V ₆ -V ₇)×	780 /	2500
26H	V ₃₈ '	V ₃ +(V ₂ -V ₃)×	1564 /	2500	V ₃₈ '	V ₇ +(V ₆ -V ₇)×	936 /	2500
27H	V ₃₉ '	V ₃ +(V ₂ -V ₃)×	1408 /	2500	V ₃₉ '	V ₇ +(V ₆ -V ₇)×	1092 /	2500
28H	V ₄₀ '	V ₃ +(V ₂ -V ₃)×	1252 /	2500	V ₄₀ '	V ₇ +(V ₆ -V ₇)×	1248 /	2500
29H	V ₄₁ '	V ₃ +(V ₂ -V ₃)×	1096 /	2500	V ₄₁ '	V ₇ +(V ₆ -V ₇)×	1404 /	2500
2AH	V ₄₂ '	V ₃ +(V ₂ -V ₃)×	940 /	2500	V ₄₂ '	V ₇ +(V ₆ -V ₇)×	1560 /	2500
2BH	V ₄₃ '	V ₃ +(V ₂ -V ₃)×	784 /	2500	V ₄₃ '	V ₇ +(V ₆ -V ₇)×	1716 /	2500
2CH	V ₄₄ '	V ₃ +(V ₂ -V ₃)×	627 /	2500	V ₄₄ '	V ₇ +(V ₆ -V ₇)×	1873 /	2500
2DH	V ₄₅ '	V ₃ +(V ₂ -V ₃)×	470 /	2500	V ₄₅ '	V ₇ +(V ₆ -V ₇)×	2030 /	2500
2EH	V ₄₆ '	V ₃ +(V ₂ -V ₃)×	313 /	2500	V ₄₆ '	V ₇ +(V ₆ -V ₇)×	2187 /	2500
2FH	V ₄₇ '	V ₃ +(V ₂ -V ₃)×	156 /	2500	V ₄₇ '	V ₇ +(V ₆ -V ₇)×	2344 /	2500
30H	V ₄₈ '	V ₃			V ₄₈ '	V ₆		
31H	V ₄₉ '	V ₄ +(V ₃ -V ₄)×	4398 /	4573	V ₄₉ '	V ₆ +(V ₅ -V ₆)×	175 /	4573
32H	V ₅₀ '	V ₄ +(V ₃ -V ₄)×	4223 /	4573	V ₅₀ '	V ₆ +(V ₅ -V ₆)×	350 /	4573
33H	V ₅₁ '	V ₄ +(V ₃ -V ₄)×	4048 /	4573	V ₅₁ '	V ₆ +(V ₅ -V ₆)×	525 /	4573
34H	V ₅₂ '	V ₄ +(V ₃ -V ₄)×	3873 /	4573	V ₅₂ '	V ₆ +(V ₅ -V ₆)×	700 /	4573
35H	V ₅₃ '	V ₄ +(V ₃ -V ₄)×	3697 /	4573	V ₅₃ '	V ₆ +(V ₅ -V ₆)×	876 /	4573
36H	V ₅₄ '	V ₄ +(V ₃ -V ₄)×	3465 /	4573	V ₅₄ '	V ₆ +(V ₅ -V ₆)×	1108 /	4573
37H	V ₅₅ '	V ₄ +(V ₃ -V ₄)×	3233 /	4573	V ₅₅ '	V ₆ +(V ₅ -V ₆)×	1340 /	4573
38H	V ₅₆ '	V ₄ +(V ₃ -V ₄)×	3001 /	4573	V ₅₆ '	V ₆ +(V ₅ -V ₆)×	1572 /	4573
39H	V ₅₇ '	V ₄ +(V ₃ -V ₄)×	2769 /	4573	V ₅₇ '	V ₆ +(V ₅ -V ₆)×	1804 /	4573
3AH	V ₅₈ '	V ₄ +(V ₃ -V ₄)×	2480 /	4573	V ₅₈ '	V ₆ +(V ₅ -V ₆)×	2093 /	4573
3BH	V ₅₉ '	V ₄ +(V ₃ -V ₄)×	2135 /	4573	V ₅₉ '	V ₆ +(V ₅ -V ₆)×	2438 /	4573
3CH	V ₆₀ '	V ₄ +(V ₃ -V ₄)×	1733 /	4573	V ₆₀ '	V ₆ +(V ₅ -V ₆)×	2840 /	4573
3DH	V ₆₁ '	V ₄ +(V ₃ -V ₄)×	1331 /	4573	V ₆₁ '	V ₆ +(V ₅ -V ₆)×	3242 /	4573
3EH	V ₆₂ '	V ₄ +(V ₃ -V ₄)×	872 /	4573	V ₆₂ '	V ₆ +(V ₅ -V ₆)×	3701 /	4573
3FH	V ₆₃ '	V ₄			V ₆₃ '	V ₅		

6. RELATIONSHIP BETWEEN INPUT DATA AND OUTPUT PIN

Data format : 6 bits x 2 RGBs (6 dots)

Input width : 36 bits (2-pixel data)

(1) R,/L = H (Right shift)

Output	S ₁	S ₂	S ₃	S ₄	...	S ₅₂₇	S ₃₈₄
Data	D ₀₀ to D ₀₅	D ₁₀ to D ₁₅	D ₂₀ to D ₂₅	D ₃₀ to D ₃₅	...	D ₄₀ to D ₄₅	D ₅₀ to D ₅₅

(2) R,/L = L (Left shift)

Output	S ₁	S ₂	S ₃	S ₄	...	S ₅₂₇	S ₃₈₄
Data	D ₀₀ to D ₀₅	D ₁₀ to D ₁₅	D ₂₀ to D ₂₅	D ₃₀ to D ₃₅	...	D ₄₀ to D ₄₅	D ₅₀ to D ₅₅

POL	Note S _{2n-1}	Note S _{2n}
L	V ₀ to V ₄	V ₅ to V ₉
H	V ₅ to V ₉	V ₀ to V ₄

Note S_{2n-1} (Odd output), S_{2n} (Even output)

7. RELATIONSHIP BETWEEN STB CLK AND OUTPUT WAVEFORM

www.DataSheet4U.com

Figure 7-1. Input Circuit Block Diagram

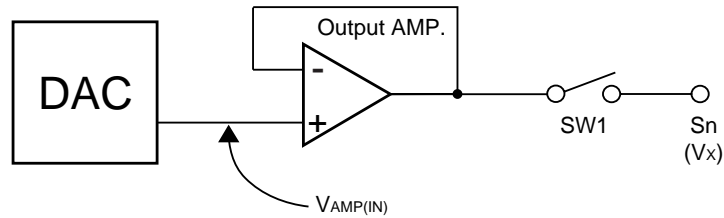
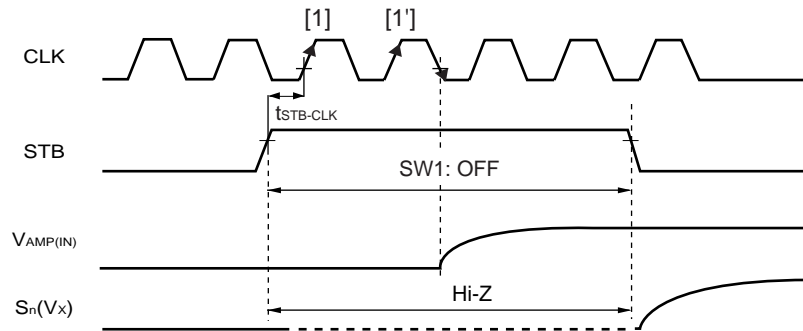

Figure 7-2. Output Circuit Timing Waveform



STB = H is loaded with the rising edge of CLK[1]. However, when not satisfying the specification of $t_{STB-CLK}$, STB = H is loaded with the rising edge of the next CLK[1']. Latch operation of display data is completed with the falling edge of the next CLK which loaded STB = H. Therefore, in order to complete latch operation of display data, it is necessary to input at least 2 CLK in STB = H period. Besides, after loading STB=H to the timing of [1], it is necessary to continue inputting CLK.

8. RELATIONSHIP BETWEEN STB, POL AND OUTPUT WAVEFORM

When the STB is high level, all outputs became Hi-Z and the gray-scale voltage is output to the LCD in synchronization with the falling edge of STB.

Therefore, high drive time of the output amplifier as below is determined by the CLK number of the required SRC pin setting. Be sure to avoid using such as extremely changing the CLK frequency (ex. CLK stop).

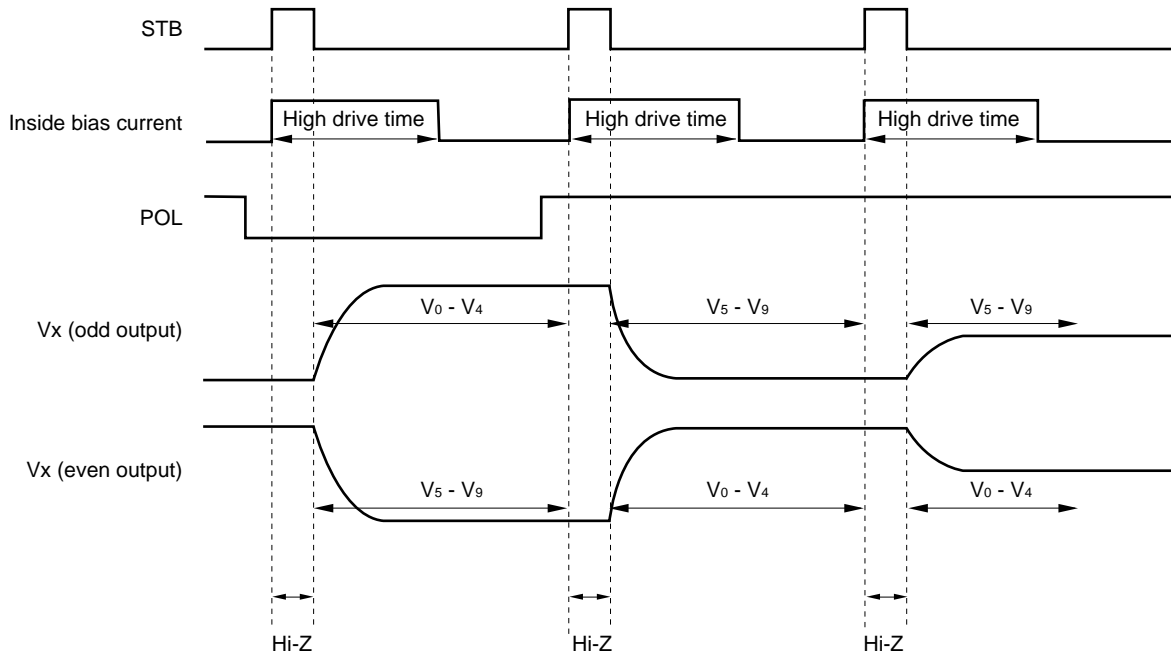

9. SRC AND HIGH DRIVE TIME

The μPD160061A can control high drive time of the output amplifier by SRC pin logic (refer to below figure).

SRC = H or open (high drive time: standard mode): High drive time (PW_{hp}) of the output amplifier is in 64 CLK period from falling edge of the STB.

SRC = L (high drive time: long-term mode): High drive time (PW_{hp}) of the output amplifier is in 128 CLK period from falling edge of the STB.

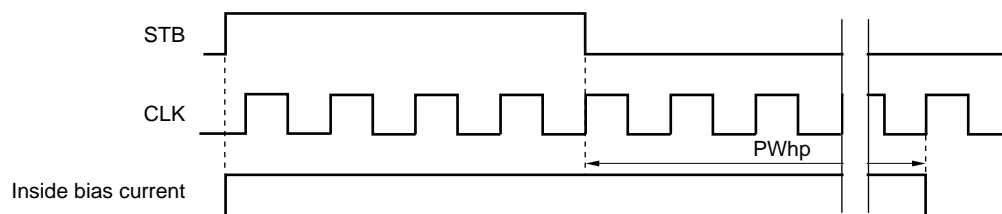

We recommend a thorough simulation of the output amplifier in advance when set the SRC pin.

10. BIAS CURRENT CONTROL BY LPC AND HPC

The μPD160061A can control the bias current of the output amplifier in high drive period and low drive period.

Bias Current	LPC	HPC
High	H	L
Middle	H or open	L
Normal	L or open	H or open
Low	H	H or open

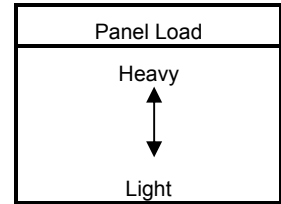

We recommend a thorough simulation of the output amplifier in advance, when set the LPC and HPC pins.
Refer to the table below for the example of the combination of setting level and panel load, with driver part supply voltage.

	Example of Condition	LPC	HPC	SRC
Example 1	Load: $R_L = 5\text{ k}\Omega$, $C_L = 75\text{ pF}$ Driver part supply voltage: $V_{DD2} = 7.5\text{ V}$	L or open	L	H or open
		Bias current mode: Middle		
Example 2	Load: $R_L = 5\text{ k}\Omega$, $C_L = 75\text{ pF}$ Driver part supply voltage: $V_{DD2} = 9.0\text{ V}$	L or open	H or open	H or open
		Bias current mode: Normal		
Example 3	Load: $R_L = 40\text{ k}\Omega$, $C_L = 80\text{ pF}$ Driver part supply voltage: $V_{DD2} = 9.0\text{ V}$	H	L	L
		Bias current mode: High		

11. ELECTRICAL SPECIFICATIONS

Absolute Maximum Ratings (T_A = 25°C, V_{SS1} = V_{SS2} = 0 V)

Parameter	Symbol	Rating	Unit
Logic Part Supply Voltage	V _{DD1}	-0.5 to +4.0	V
Driver Part Supply Voltage	V _{DD2}	-0.5 to +10.0	V
Logic Part Input Voltage	V _{I1}	-0.5 to V _{DD1} + 0.5	V
Driver Part Input Voltage	V _{I2}	-0.5 to V _{DD2} + 0.5	V
Logic Part Output Voltage	V _{O1}	-0.5 to V _{DD1} + 0.5	V
Driver Part Output Voltage	V _{O2}	-0.5 to V _{DD2} + 0.5	V
Operating Ambient Temperature	T _A	-10 to +75	°C
Storage Temperature	T _{stg}	-55 to +125	°C

Caution Product quality may suffer if the absolute maximum rating is exceeded even momentarily for any parameter. That is, the absolute maximum ratings are rated values at which the product is on the verge of suffering physical damage, and therefore the product must be used under conditions that ensure that the absolute maximum ratings are not exceeded.

Recommended Operating Range (T_A = -10 to +75°C, V_{SS1} = V_{SS2} = 0 V)

Parameter	Symbol	Condition	MIN.	TYP.	MAX.	Unit
Logic Part Supply Voltage	V _{DD1}		2.3		3.6	V
Driver Part Supply Voltage	V _{DD2}		7.5	8.5	9.5	V
High-Level Input Voltage	V _{IH}		0.7 V _{DD1}		V _{DD1}	V
Low-Level Input Voltage	V _{IL}		0		0.3 V _{DD1}	V
γ-Corrected Voltage	V ₀ to V ₄ V ₅ to V ₉	7.5 V ≤ V _{DD1} ≤ 9.5 V	0.5 V _{DD2}		V _{DD2} - 0.2	V
		7.5 V ≤ V _{DD1} < 8.5 V	0.2		0.5 V _{DD2} - 0.3	V
		8.5 V ≤ V _{DD1} ≤ 9.5 V	0.2		0.5 V _{DD2}	V
Driver Part Output Voltage	V _O		0.2		V _{DD2} - 0.2	V
Clock Frequency	f _{CLK}	2.3 V ≤ V _{DD1} < 2.7 V			40	MHz
		2.7 V ≤ V _{DD1} ≤ 3.6 V			65	MHz

★ **Electrical Characteristics (T_A = -10 to +75°C, V_{DD1} = 2.3 to 3.6 V, V_{DD2} = 7.5 to 9.5 V, V_{SS1} = V_{SS2} = 0 V)**

Parameter	Symbol	Condition	MIN.	TYP.	MAX.	Unit
Input Leak Current	I _{IL}	Except LPC, HPC, SRC			±1.0	μA
		LPC, HPC, SRC			±150	μA
High-Level Output Voltage	V _{OH}	STHR (STHL), I _{OH} = 0 mA	V _{DD1} - 0.1			V
Low-Level Output Voltage	V _{OL}	STHR (STHL), I _{OL} = 0 mA			0.1	V
γ-Corrected Resistance	R _γ	V ₀ to V ₄ = V ₅ to V ₉ = 4.0 V, V _{DD2} = 8.5 V	7.9	15.8	23.7	kΩ
Driver Output Current	I _{VOH}	V _{DD2} = 8.0 V, V _X = 7.0 V, V _{OUT} = 6.5 V ^{Note1}			- 20	μA
	I _{VOL}	V _{DD2} = 8.0 V, V _X = 1.0 V, V _{OUT} = 1.5 V ^{Note1}	20			μA
Output Voltage Deviation	ΔV _O	T _A = 25°C,		±10	±20	mV
Output Swing Difference Deviation	ΔV _{P-P}	V _{DD1} = 3.3 V, V _{DD2} = 8.5 V, V _{OUT} = 2.0 V, 4.25 V, 6.5 V		±3	±15	mV
Logic Part Dynamic Current Consumption ^{Note2, 3, 4}	I _{DD1}	V _{DD1}		4	12	mA
Driver Part Dynamic Current Consumption ^{Note2, 4}	I _{DD22}	V _{DD2} , with no load		3.5	8	mA

- Notes**
1. V_X refers to the output voltage of analog output pins S₁ to S₃₈₄. V_{OUT} refers to the voltage applied to analog output pins S₁ to S₃₈₄.
 2. Specified at f_{STB} = 65 kHz and f_{CLK} = 54 MHz.
 3. The TYP. values refer to an all black or all white input pattern. The MAX. value refers to the measured values in the dot checkerboard input pattern.
 4. Refers to the current consumption per driver when cascades are connected under the assumption of XGA single-sided mounting (8 units).

Switching Characteristics (T_A = -10 to +75°C, V_{DD1} = 2.3 to 3.6 V, V_{DD2} = 7.5 to 9.5 V, V_{SS1} = V_{SS2} = 0 V)

Parameter	Symbol	Condition	MIN.	TYP.	MAX.	Unit
Start Pulse Delay Time	t _{PLH1}	C _L = 15 pF, 2.3 V ≤ V _{DD1} < 2.7 V			20	ns
		C _L = 10 pF, 2.7 V ≤ V _{DD1} ≤ 3.6 V			10.5	ns
	t _{PLH1}	C _L = 10 pF, 2.3 V ≤ V _{DD1} < 2.7 V			20	ns
		C _L = 10 pF, 2.7 V ≤ V _{DD1} ≤ 3.6 V			10.5	ns
Driver Output Delay Time	t _{PLH2}	C _L = 75 pF, R _L = 5 kΩ,			5	μs
	t _{PLH3}	LPC = L or open,			8	μs
	t _{PHL2}	HPC = H or open,			5	μs
	t _{PHL3}	SRC = H or open			8	μs
Input Capacitance	C _{i1}	Logic input of exclude STHR (STHL), T _A = 25°C			10	pF
	C _{i2}	STHR (STHL), T _A = 25°C			5	pF

<Measurement condition>

R_{Ln} = 1 kΩ, C_{Ln} = 15 pF

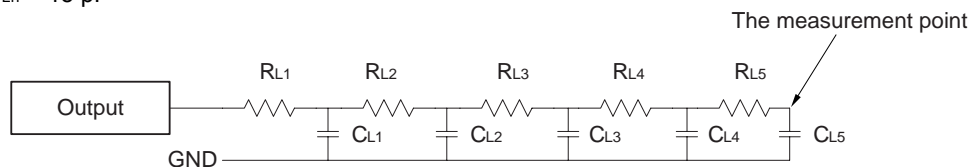

Timing Requirements (T_A = -10 to +75°C, V_{DD1} = 2.3 to 3.6 V, V_{SS1} = 0 V, t_r = t_f = 5.0 ns)

Parameter	Symbol	Condition	MIN.	TYP.	MAX.	Unit
Clock Pulse Width	PW _{CLK}	2.3 V ≤ V _{DD1} < 2.7 V	25			ns
		2.7 V ≤ V _{DD1} ≤ 3.6 V	15			ns
Clock Pulse High Period	PW _{CLK(H)}	2.3 V ≤ V _{DD1} < 2.7 V	6			ns
		2.7 V ≤ V _{DD1} ≤ 3.6 V	4			ns
Clock Pulse Low Period	PW _{CLK(L)}	2.3 V ≤ V _{DD1} < 2.7 V	6			ns
		2.7 V ≤ V _{DD1} ≤ 3.6 V	4			ns
Data Setup Time	t _{SETUP1}		4			ns
Data Hold Time	t _{HOLD1}		0			ns
Start Pulse Setup Time	t _{SETUP2}		4			ns
Start Pulse Hold Time	t _{HOLD2}		0			ns
POL21, POL22 Setup Time	t _{SETUP3}		4			ns
POL21, POL22 Hold Time	t _{HOLD3}		0			ns
STB Pulse Width	PW _{STB}		2			CLK
Last Data Timing	t _{LDT}		2			CLK
STB-CLK Time	t _{STB-CLK}	STB ↑ → CLK ↑	9			ns
Time Between STB and Start Pulse	t _{STB-STH}	STB ↑ → STHR(STHL) ↑	2			CLK
POL-STB Time	t _{POL-STB}	POL ↑ or ↓ → STB ↑	-5			ns
STB-POL Time	t _{STB-POL}	STB ↓ → POL ↓ or ↑	6			ns

Remark Unless otherwise specified, the input level is defined to be V_{IH} = 0.7 V_{DD1}, V_{IL} = 0.3 V_{DD1}.

12. RECOMMENDED MOUNTING CONDITIONS

The following conditions must be met for mounting conditions of the μPD160061A.

For more details, refer to the **Semiconductor Device Mount Manual**

(<http://www.necel.com/pkg/en/mount/index.html>).

Please consult with our sales offices in case other mounting process is used, or in case the mounting is done under different conditions.

μPD160061AN - xxx: TCP (TAB package)

Mounting Condition	Mounting Method	Condition
Thermocompression	Soldering	Heating tool 300 to 350°C, heating for 2 to 3 seconds, pressure 100 g (per solder)
	ACF (Adhesive Conductive Film)	Temporary bonding 70 to 100°C, pressure 3 to 8 kg/cm ² , time 3 to 5 seconds. Real bonding 165 to 180°C, pressure 25 to 45 kg/cm ² , time 30 to 40 seconds. (When using the anisotropy conductive film SUMIZAC1003 of Sumitomo Bakelite, Ltd.)

Caution To find out the detailed conditions for mounting the ACF part, please contact the ACF manufacturing company. Be sure to avoid using two or more mounting methods at a time.

NOTES FOR CMOS DEVICES

① PRECAUTION AGAINST ESD FOR SEMICONDUCTORS

Note:

Strong electric field, when exposed to a MOS device, can cause destruction of the gate oxide and ultimately degrade the device operation. Steps must be taken to stop generation of static electricity as much as possible, and quickly dissipate it once, when it has occurred. Environmental control must be adequate. When it is dry, humidifier should be used. It is recommended to avoid using insulators that easily build static electricity. Semiconductor devices must be stored and transported in an anti-static container, static shielding bag or conductive material. All test and measurement tools including work bench and floor should be grounded. The operator should be grounded using wrist strap. Semiconductor devices must not be touched with bare hands. Similar precautions need to be taken for PW boards with semiconductor devices on it.

② HANDLING OF UNUSED INPUT PINS FOR CMOS

Note:

No connection for CMOS device inputs can be cause of malfunction. If no connection is provided to the input pins, it is possible that an internal input level may be generated due to noise, etc., hence causing malfunction. CMOS devices behave differently than Bipolar or NMOS devices. Input levels of CMOS devices must be fixed high or low by using a pull-up or pull-down circuitry. Each unused pin should be connected to V_{DD} or GND with a resistor, if it is considered to have a possibility of being an output pin. All handling related to the unused pins must be judged device by device and related specifications governing the devices.

③ STATUS BEFORE INITIALIZATION OF MOS DEVICES

Note:

Power-on does not necessarily define initial status of MOS device. Production process of MOS does not define the initial operation status of the device. Immediately after the power source is turned ON, the devices with reset function have not yet been initialized. Hence, power-on does not guarantee out-pin levels, I/O settings or contents of registers. Device is not initialized until the reset signal is received. Reset operation must be executed immediately after power-on for devices having reset function.