

# LM3691

## High Accuracy, Miniature 1A, Step-Down DC-DC Converter for Portable Applications

### General Description

The LM3691 step-down DC-DC converter is optimized for powering ultra-low voltage circuits from a single Li-Ion cell or 3 cell NiMH/NiCd batteries. It provides up to 1A load current, over an input voltage range from 2.3V to 5.5V. There are several different fixed voltage output options available.

LM3691 has a mode-control pin that allows the user to select Forced PWM mode or ECO mode that changes modes between gated PWM mode and PWM automatically depending on the load. In ECO, LM3691 offers superior efficiency and very low  $I_q$  under light load conditions. ECO mode extends the battery life through reduction of the quiescent current during light load conditions and system standby.

The LM3691 is available in a 6-bump micro SMD package. Only three external surface-mount components, a 1  $\mu$ H inductor, a 4.7  $\mu$ F input capacitor and a 4.7  $\mu$ F output capacitor, are required.

### Features

- $V_{OUT} = 0.75V$  to  $3.3V$
- $\pm 1\%$  DC output voltage precision
- $2.3 \leq V_{IN} \leq 5.5V$
- 4 MHz switching frequency
- 64  $\mu A$  (typ.) quiescent current in ECO mode
- 1A maximum load capability
- Automatic ECO/PWM mode switching
- Mode Pin to select ECO/Forced PWM mode
- 1  $\mu H$  inductor, 4.7  $\mu F$  input capacitor (0603(1608) case size) and 4.7  $\mu F$  output capacitor (0603(1608) case size)
- Current overload and thermal shutdown protections
- Only three tiny surface-mount external components required (solution size less than 15 mm<sup>2</sup>)

### Applications

- Mobile Phones
- Hand-Held Radios
- MP3 players
- Portable Hard Disk Drives

### Typical Application Circuit

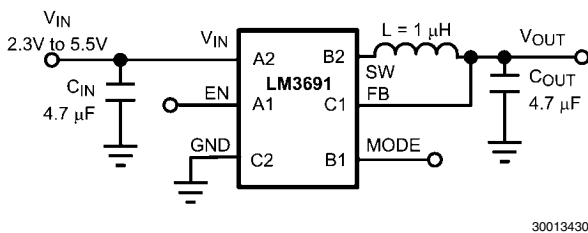

30013430

FIGURE 1. Typical Application Circuit

Efficiency vs. Output Current  
( $V_{OUT} = 1.8V$ , ECO Mode)

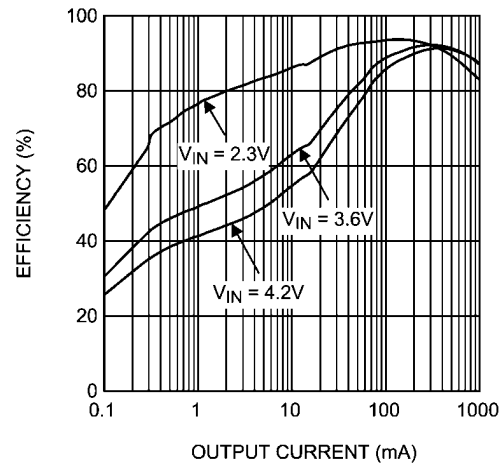

30013466

## Connection Diagram and Package Mark Information

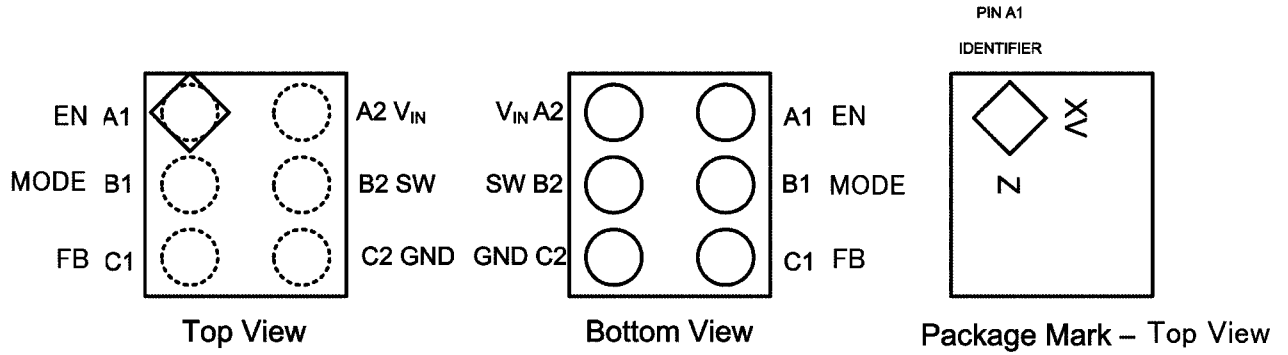

30013406

**FIGURE 2. 6-Bump Thin Micro SMD Package, Large Bump  
NS Package Number TLA06LCA**

Note: The actual physical placement of the package marking will vary from part to part. The package marking "X" designates the date code; "V" is an NSC internal code for die traceability. Both will vary in production.

### Pin Descriptions

Pin Micro SMD	Name	Description
A1	EN	Enable pin. The device is in shutdown mode when voltage to this pin is <0.4V and enabled when >1.2V. Do not leave this pin floating.
B1	Mode	Mode Pin: Mode = 1, Forced PWM Mode = 0, ECO Do not leave this pin floating.
C1	FB	Feedback analog input. Connect directly to the output filter capacitor. (Figure 1)
A2	VIN	Power supply input. Connect to the input filter capacitor. (Figure 1)
B2	SW	Switching node connection to the internal PFET switch and NFET synchronous rectifier.
C2	GND	Ground pin.

## Ordering Information

Voltage Option V	Order Number 6-bump Micro SMD	Package Marking	Supplied As
0.75	LM3691TL-0.75	V	250 units, Tape-and-Reel
	LM3691TLX-0.75	V	3000 units, Tape-and-Reel
0.85*	LM3691TL-0.85	TBD	250 units, Tape-and-Reel
	LM3691TLX-0.85	TBD	3000 units, Tape-and-Reel
0.9*	LM3691TL-0.9	TBD	250 units, Tape-and-Reel
	LM3691TLX-0.9	TBD	3000 units, Tape-and-Reel
1.0*	LM3691TL-1.0	TBD	250 units, Tape-and-Reel
	LM3691TLX-1.0	TBD	3000 units, Tape-and-Reel
1.1*	LM3691TL-1.1	TBD	250 units, Tape-and-Reel
	LM3691TLX-1.1	TBD	3000 units, Tape-and-Reel
1.2	LM3691TL-1.2	X	250 units, Tape-and-Reel
	LM3691TLX-1.2	X	3000 units, Tape-and-Reel
1.3*	LM3691TL-1.3	TBD	250 units, Tape-and-Reel
	LM3691TLX-1.3	TBD	3000 units, Tape-and-Reel
1.375*	LM3691TL-1.375	TBD	250 units, Tape-and-Reel
	LM3691TLX-1.375	TBD	3000 units, Tape-and-Reel
1.5	LM3691TL-1.5	Y	250 units, Tape-and-Reel
	LM3691TLX-1.5	Y	3000 units, Tape-and-Reel
1.6*	LM3691TL-1.6	TBD	250 units, Tape-and-Reel
	LM3691TLX-1.6	TBD	3000 units, Tape-and-Reel
1.8	LM3691TL-1.8	Z	250 units, Tape-and-Reel
	LM3691TLX-1.8	Z	3000 units, Tape-and-Reel
2.5	LM3691TL-2.5	8	250 units, Tape-and-Reel
	LM3691TLX-2.5	8	3000 units, Tape-and-Reel
3.3*	LM3691TL-3.3	TBD	250 units, Tape-and-Reel
	LM3691TLX-3.3	TBD	3000 units, Tape-and-Reel

\* If any of the voltage options other than the released voltages are required, please contact the National Semiconductor Sales Office/Distributors for availability.

## Absolute Maximum Ratings (Note 1)

If Military/Aerospace specified devices are required, please contact the National Semiconductor Sales Office/Distributors for availability and specifications.

If Military/Aerospace specified devices are required, please contact the National Semiconductor Sales Office/Distributors for availability and specifications.

$V_{IN}$ Pin to GND	-0.2V to 6.0V
EN, MODE pin to GND	-0.2V to 6.0V
FB, SW pin	(GND-0.2V) to ( $V_{IN} + 0.2V$ ) w/ 6.0V max
Junction Temperature ( $T_{J-MAX}$ )	+150°C
Storage Temperature Range	-65°C to +150°C
Continuous Power Dissipation (Note 3)	Internally Limited
Maximum Lead Temperature (Soldering, 10 sec.)	260°C
ESD Rating (Note 4)	
Human Body Model	2 kV
Machine Model	200V

## Operating Ratings (Notes 1, 2)

Input Voltage Range	2.3V to 5.5V
Recommended Load Current	0 mA to 1000 mA
Junction Temperature ( $T_J$ ) Range	-30°C to +125°C
Ambient Temperature ( $T_A$ ) Range (Note 5)	-30°C to +85°C

## Thermal Properties

Junction-to-Ambient Thermal Resistance ( $\theta_{JA}$ ) (Note 6) (micro SMD)	85°C/W
---	--------

**Electrical Characteristics** (Notes 2, 7, 8) Limits in standard typeface are for  $T_A = 25^\circ\text{C}$ . Limits in **boldface** type apply over the operating ambient temperature range ( $-30^\circ\text{C} \leq T_A = T_J \leq +85^\circ\text{C}$ ). Unless otherwise noted, specifications apply to the LM3691 open loop Typical Application Circuit with  $V_{IN} = EN = 3.6V$ .

Symbol	Parameter	Condition	Min	Typ	Max	Units
$V_{FB}$	Feedback Voltage	PWM Mode. No load $V_{OUT} = 1.1V$ to 3.3V	<b>-1</b>		<b>+1</b>	%
		PWM Mode. No load $V_{OUT} = 0.75V$ to 1.0V	<b>-10</b>		<b>+10</b>	mV
$I_{SHDN}$	Shutdown Supply Current	EN = 0V		0.03	<b>1</b>	$\mu\text{A}$
$I_{Q\_ECO}$	ECO Mode $I_q$	ECO Mode		64	<b>80</b>	$\mu\text{A}$
$I_{Q\_PWM}$	PWM Mode $I_q$	PWM Mode		490	<b>600</b>	$\mu\text{A}$
$R_{DS(on)(P)}$	Pin-Pin Resistance for PFET	$V_{IN} = V_{GS} = 3.6V$ , $I_O = 200\text{ mA}$		160	<b>250</b>	m $\Omega$
$R_{DS(on)(N)}$	Pin-Pin Resistance for NFET	$V_{IN} = V_{GS} = 3.6V$ , $I_O = -200\text{ mA}$		115	<b>180</b>	m $\Omega$
$I_{LIM}$	Switch Peak Current Limit	Open loop	<b>1250</b>	1500	<b>1700</b>	mA
$V_{IH}$	Logic High Input		<b>1.2</b>			V
$V_{IL}$	Logic Low Input				<b>0.4</b>	V
$I_{EN,MODE}$	Input Current			0.01	<b>1</b>	$\mu\text{A}$
$F_{SW}$	Switching Frequency	PWM Mode	<b>3.6</b>	4	<b>4.4</b>	MHz
$V_{ON}$	UVLO threshold	$V_{IN}$ rising		2.2		V
		$V_{IN}$ falling		2.1		V

**Note 1:** Absolute Maximum Ratings indicate limits beyond which damage to the component may occur. Operating Ratings are conditions under which operation of the device is guaranteed. Operating Ratings do not imply guaranteed performance limits. For guaranteed performance limits and associated test conditions, see the Electrical Characteristics tables.

**Note 2:** All voltages are with respect to the potential at the GND pin.

**Note 3:** Internal thermal shutdown circuitry protects the device from permanent damage. Thermal shutdown engages at  $T_J = 150^\circ\text{C}$  (typ.) and disengages at  $T_J = 130^\circ\text{C}$  (typ.).

**Note 4:** The Human body model is a 100 pF capacitor discharged through a 1.5 k $\Omega$  resistor into each pin. The machine model is a 200 pF capacitor discharged directly into each pin. MIL-STD-883 3015.7

**Note 5:** In applications where high power dissipation and/or poor package resistance is present, the maximum ambient temperature may have to be derated. Maximum ambient temperature ( $T_{A-MAX}$ ) is dependent on the maximum operating junction temperature ( $T_{J-MAX}$ ), the maximum power dissipation of the device in the application ( $P_{D-MAX}$ ) and the junction to ambient thermal resistance of the package ( $\theta_{JA}$ ) in the application, as given by the following equation:  $T_{A-MAX} = T_{J-MAX} - (\theta_{JA} \times P_{D-MAX})$ . Due to the pulsed nature of testing the part, the temp in the Electrical Characteristic table is specified as  $T_A = T_J$ .

**Note 6:** Junction-to-ambient thermal resistance is highly application and board layout dependent. In applications where high power dissipation exists, special care must be given to thermal dissipation issues in board design.

**Note 7:** Min and Max limits are guaranteed by design, test or statistical analysis. Typical numbers are not guaranteed, but do represent the most likely norm.

**Note 8:** The parameters in the electrical characteristic table are tested under open loop conditions at  $V_{IN} = 3.6V$  unless otherwise specified. For performance over the input voltage range and closed loop condition, refer to the datasheet curves.

# Block Diagram

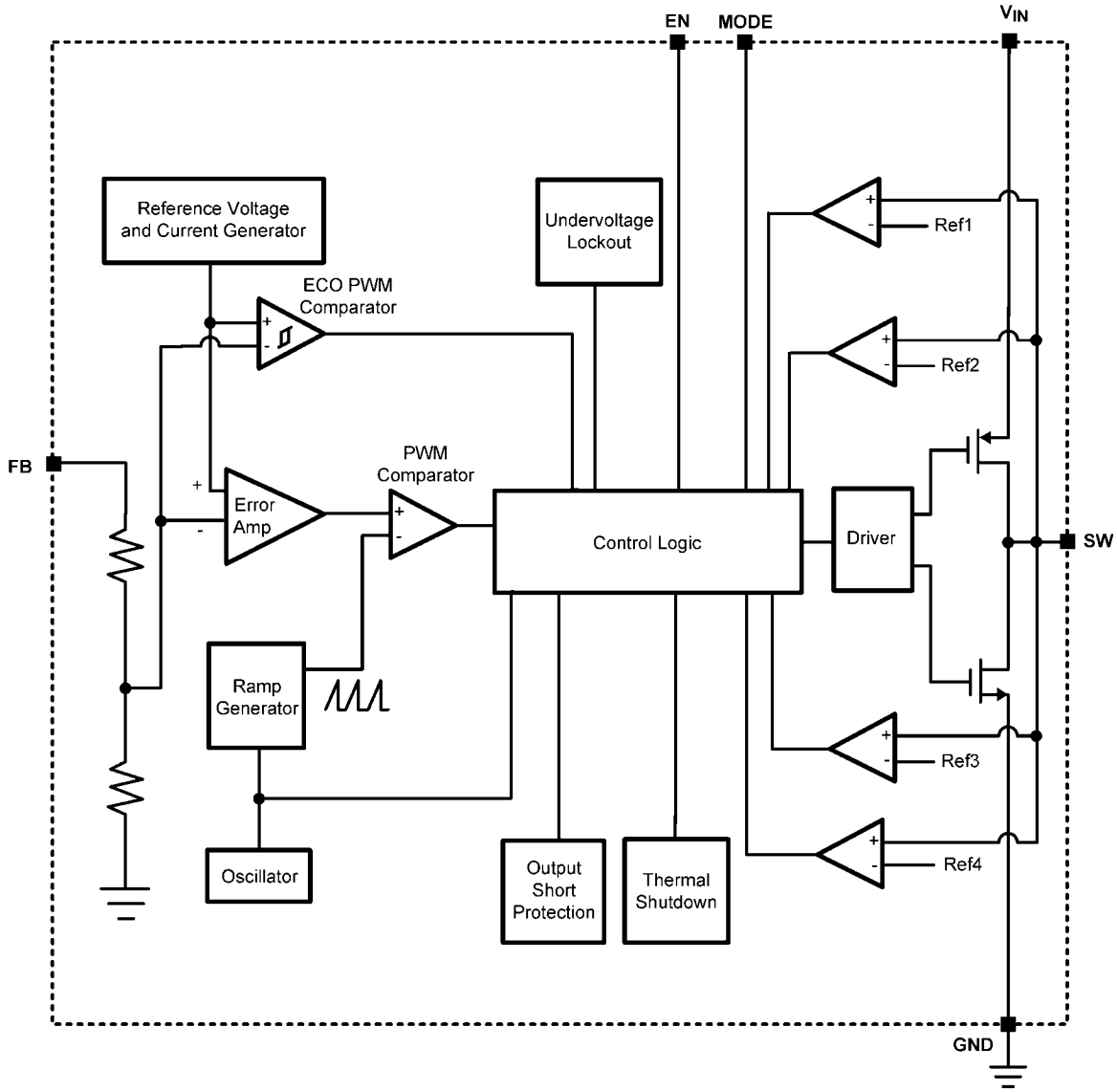

30013431

FIGURE 3. Simplified Functional Diagram

**Typical Performance Characteristics** LM3691TL Typical Application Circuit (page 1),  $V_{IN} = 3.6V$ ,  $V_{OUT} = 1.8V$ ,  $T_A = 25^\circ$ ,  $L = 1.0 \mu H$ , 2520, (LQM2HP1R0),  $C_{IN} = C_{OUT} = 4.7 \mu F$ , 0603(1608), 6.3V, (C1608X5R0J475K) unless otherwise noted.

**Quiescent Supply current vs. Supply Voltage  
No Switching (ECO Mode)**

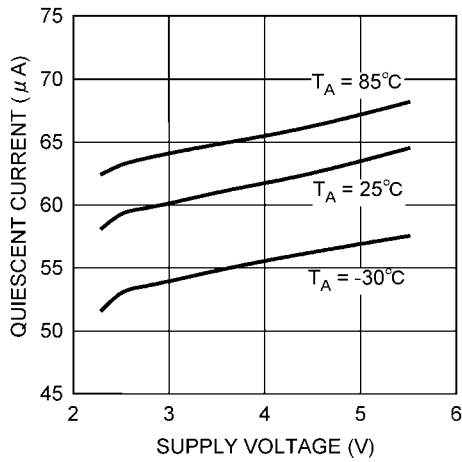

30013455

**Quiescent Supply current vs. Supply Voltage  
No Switching (PWM Mode)**

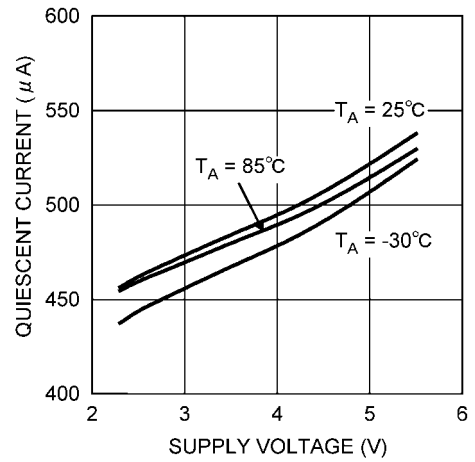

30013456

**Shutdown Current vs. Temp  
( $V_{OUT} = 1.8V$ )**

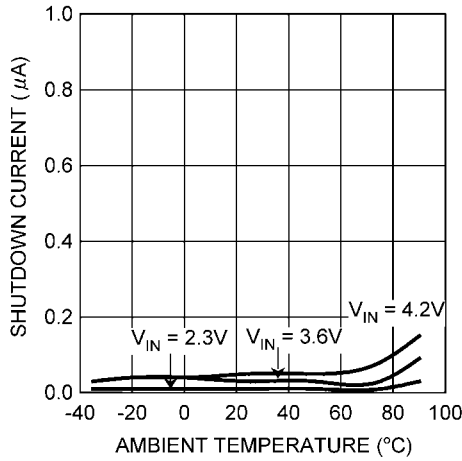

30013457

**Switching Frequency vs. Temp  
( $V_{OUT} = 1.8V$ , PWM Mode)**

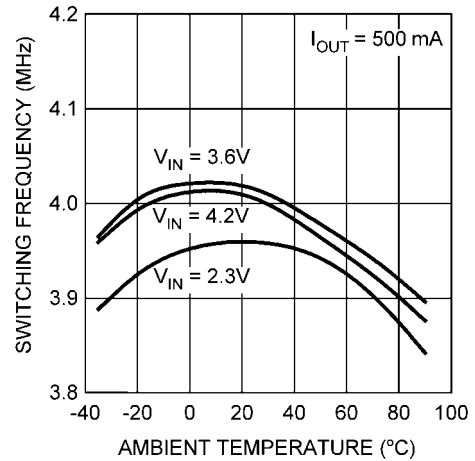

30013458

**Output Voltage vs. Supply Voltage**  
( $V_{OUT} = 0.75V$ )

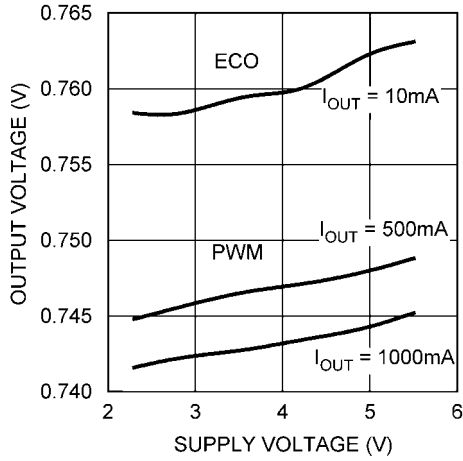

30013459

**Output Voltage vs. Supply Voltage**  
( $V_{OUT} = 1.8V$ )

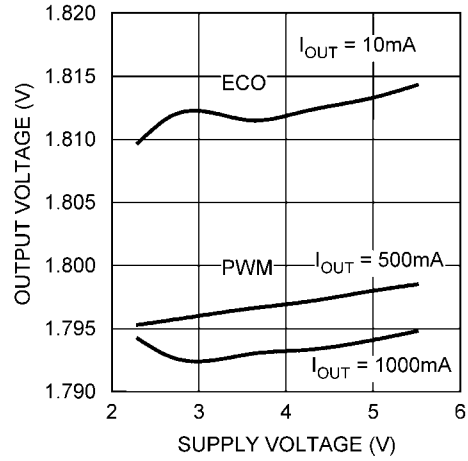

30013460

**Output Voltage vs. Output Current**  
( $V_{OUT} = 0.75V$ )

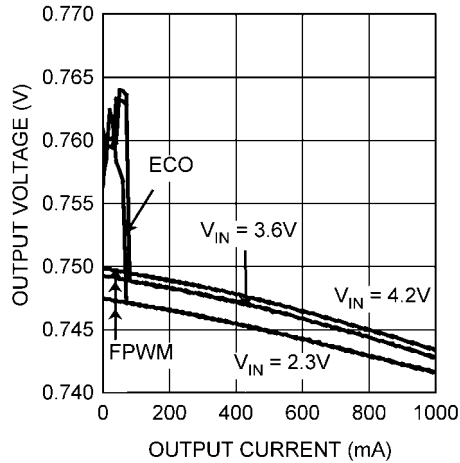

30013461

**Output Voltage vs. Output Current**  
( $V_{OUT} = 1.8V$ )

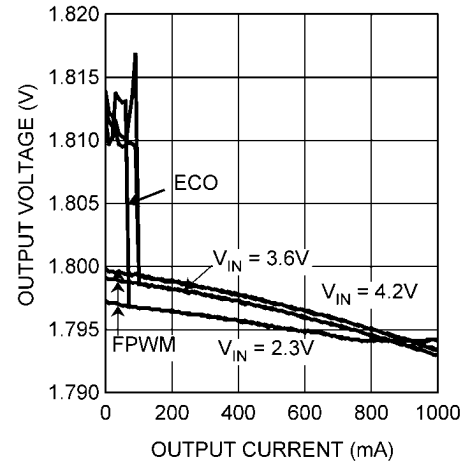

30013462

**Input Current vs. Output Current**  
( $V_{OUT} = 0.75V$ )

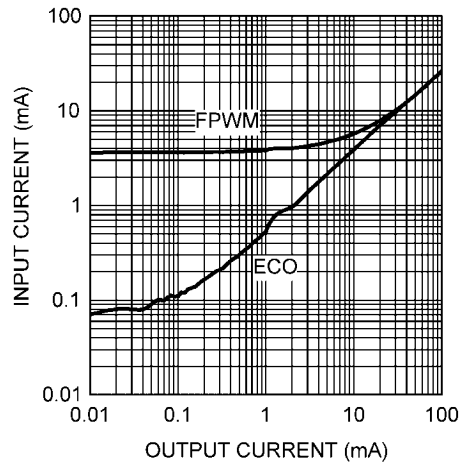

30013463

**Input Current vs. Output Current**  
( $V_{OUT} = 1.8V$ )

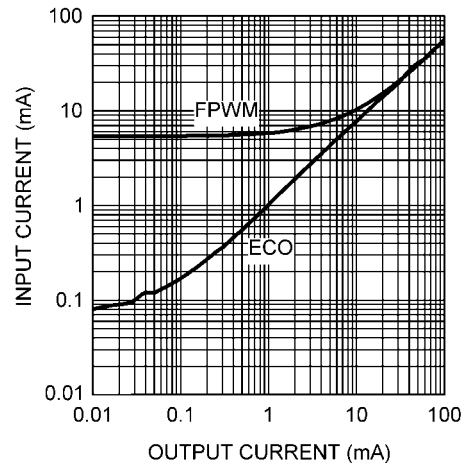

30013464

**Efficiency vs. Output Current**  
( $V_{OUT} = 0.75V$ , ECO Mode)

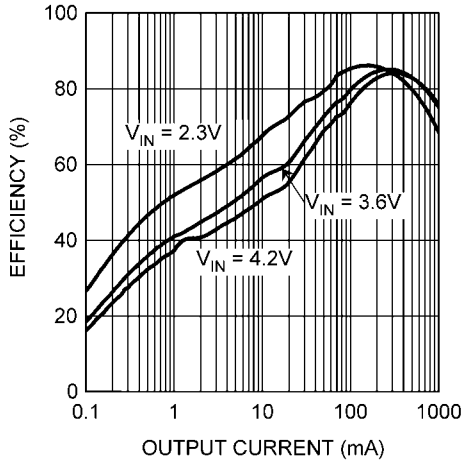

30013465

**Efficiency vs. Output Current**  
( $V_{OUT} = 1.8V$ , ECO Mode)

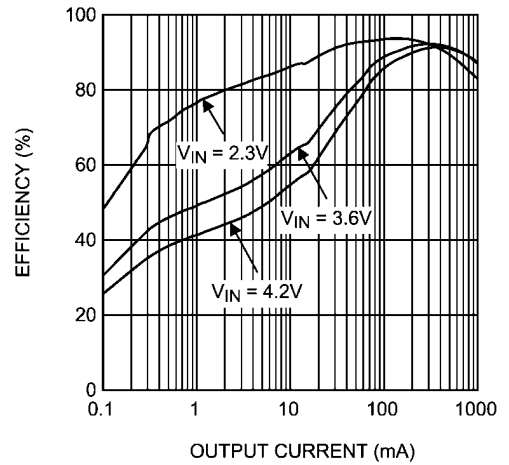

30013466

**Efficiency vs. Output Current**  
( $V_{OUT} = 2.5V$ , ECO Mode)

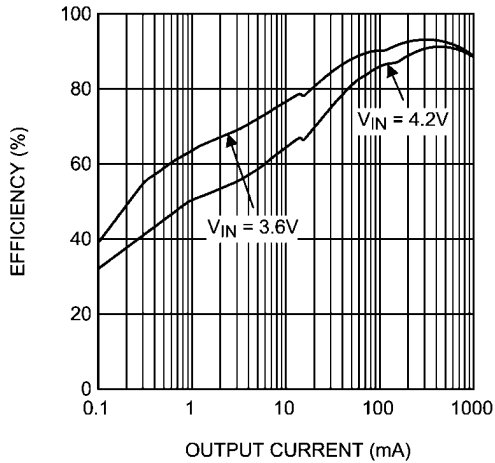

30013443

**Efficiency vs. Output Current**  
( $V_{OUT} = 0.75V$ , FPWM Mode)

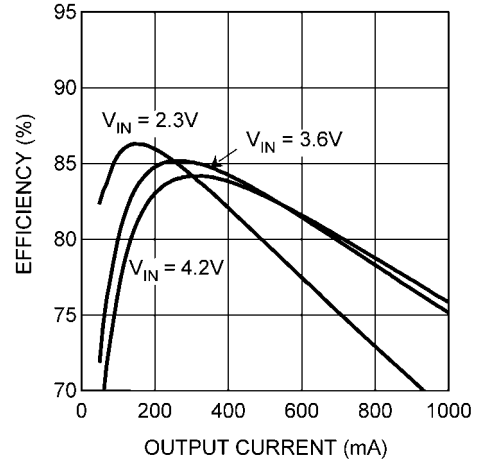

30013467

**Efficiency vs. Output Current**  
( $V_{OUT} = 1.8V$ , FPWM Mode)

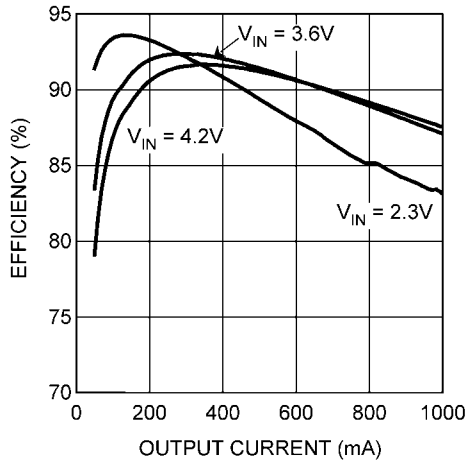

30013468

**Efficiency vs. Output Current**  
( $V_{OUT} = 2.5V$ , FPWM Mode)

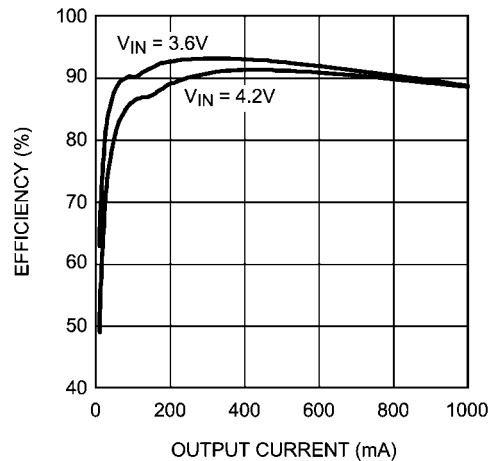

300134a0



**Load Current Threshold vs. Supply Voltage**  
( $V_{OUT} = 0.75V$ , ECO Mode to PWM Mode)

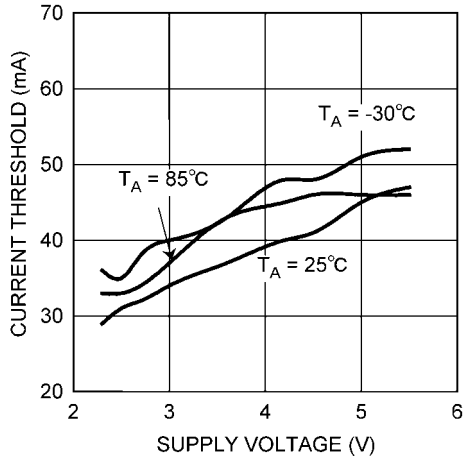

30013469

**Load Current Threshold vs. Supply Voltage**  
( $V_{OUT} = 1.8V$ , ECO Mode to PWM Mode)

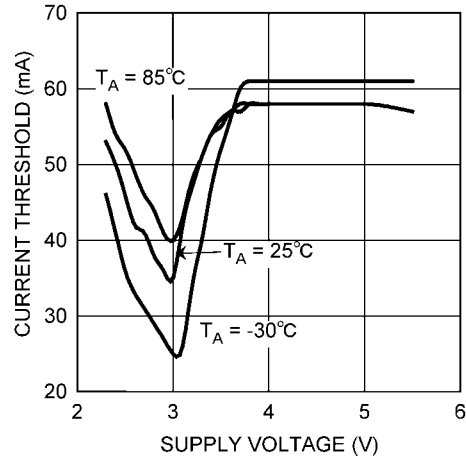

30013470

**Output Voltage Ripple vs. Supply Voltage**  
( $V_{OUT} = 0.75V$ )

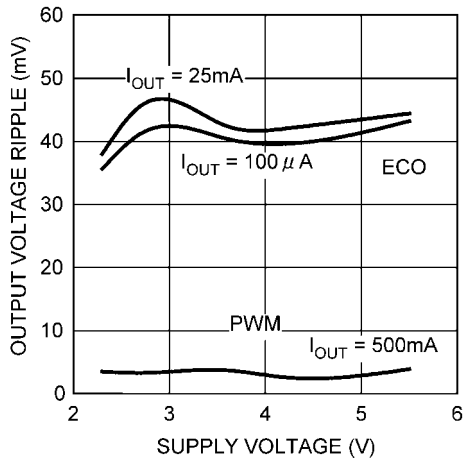

30013471

**Output Voltage Ripple vs. Supply Voltage**  
( $V_{OUT} = 1.8V$ )

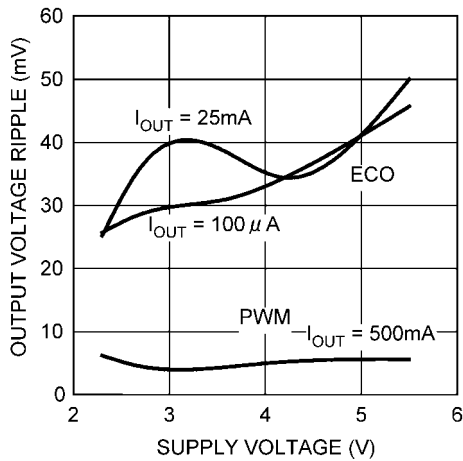

30013472

**Closed Loop Current Limit vs. Temperature**  
( $V_{OUT} = 0.75V$ )

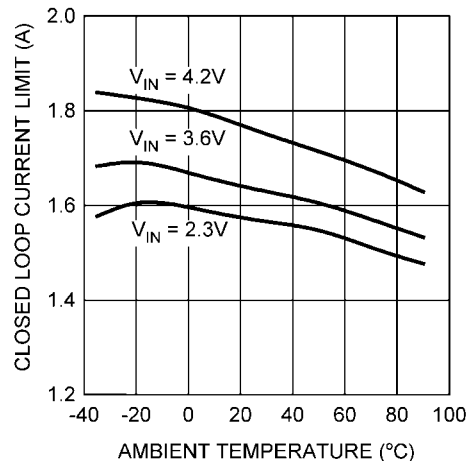

30013473

**Closed Loop Current Limit vs. Temperature**  
( $V_{OUT} = 1.8V$ )

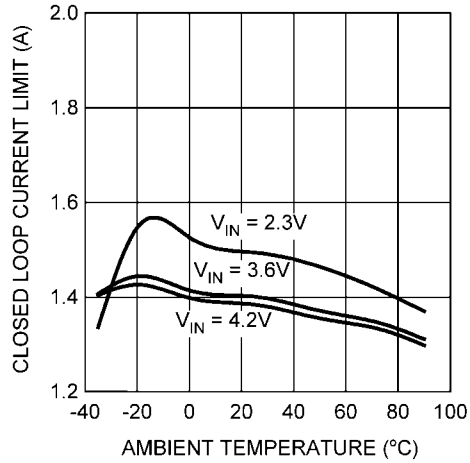

30013474

**Line Transient Response**  
( $V_{OUT} = 0.75V$ , PWM Mode)

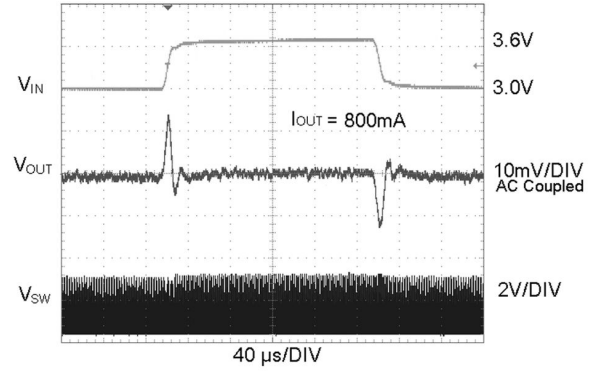

30013475

**Line Transient Response**  
( $V_{OUT} = 1.8V$ , PWM Mode)

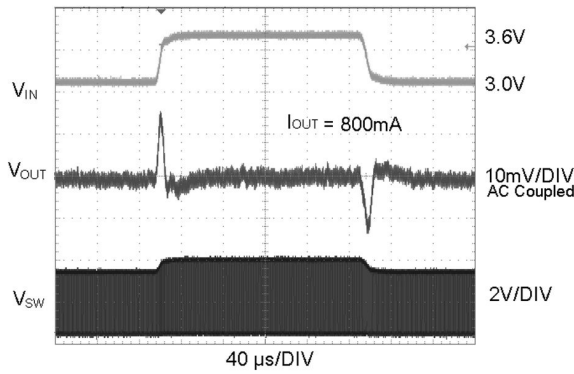

30013478

**Load Transient Response**  
( $V_{OUT} = 0.75V$ , ECO Mode 1mA to 25 mA)

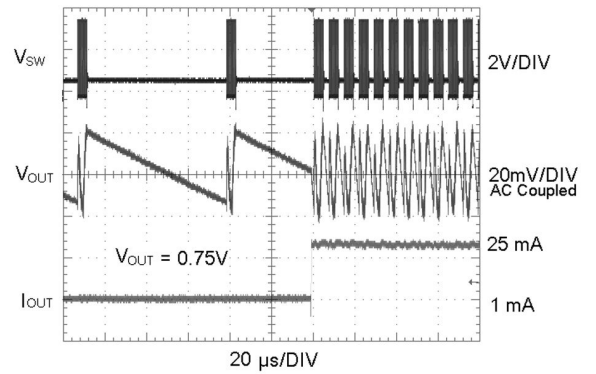

30013479

**Load Transient Response**  
( $V_{OUT} = 0.75V$ , ECO Mode 25 mA to 1mA)

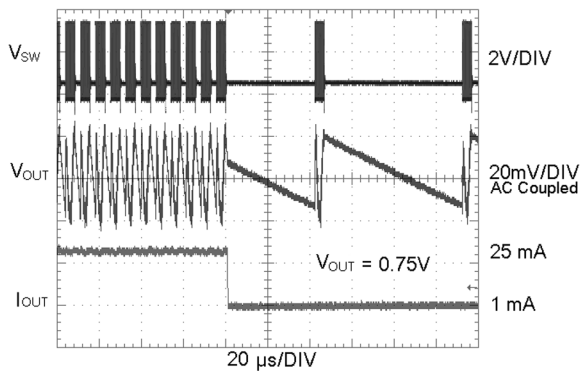

30013480

**Load Transient Response**  
( $V_{OUT} = 1.8V$ , ECO Mode 1mA to 25 mA)

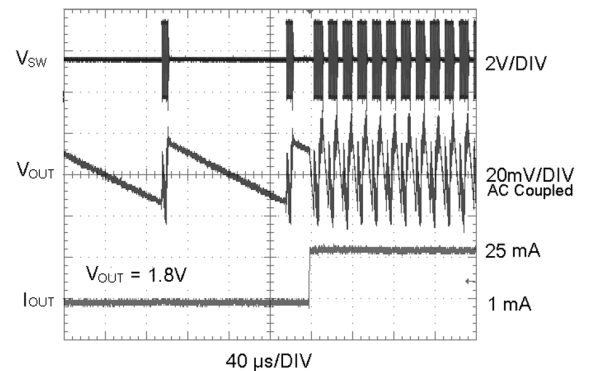

30013481

**Load Transient Reponse**  
( $V_{OUT} = 1.8V$ , ECO Mode 25 mA to 1mA)

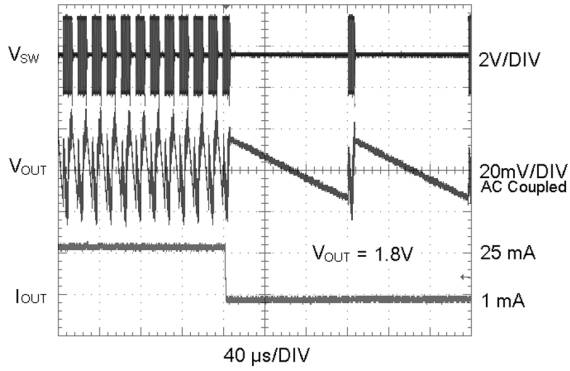

30013482

**Load Transient Reponse**  
( $V_{OUT} = 0.75V$ , ECO Mode to PWM Mode)

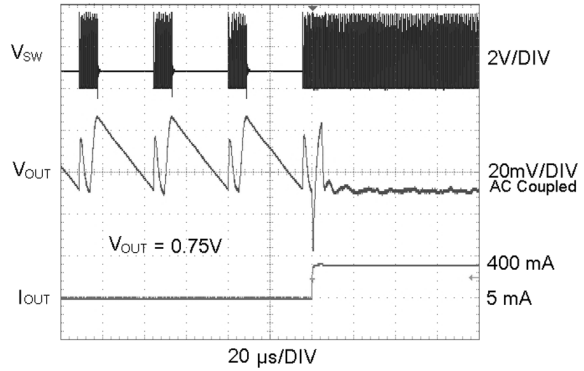

30013483

**Load Transient Reponse**  
( $V_{OUT} = 0.75V$ , PWM Mode to ECO Mode)

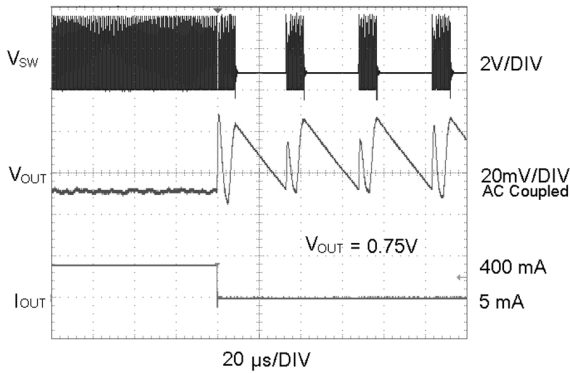

30013484

**Load Transient Reponse**  
( $V_{OUT} = 1.8V$ , ECO Mode to PWM Mode)

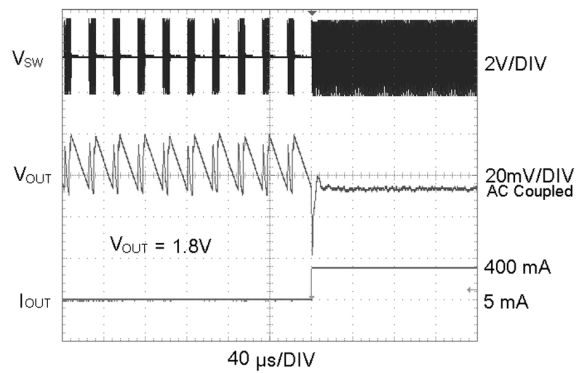

30013485

**Load Transient Reponse**  
( $V_{OUT} = 2.5V$ , ECO Mode to PWM Mode)

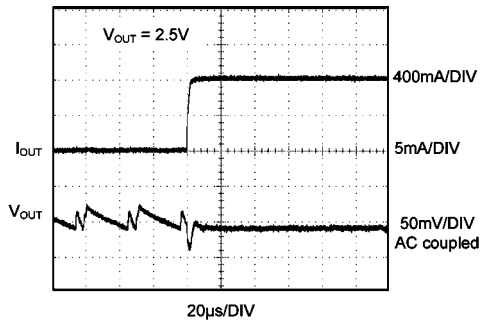

30013452

**Load Transient Reponse**  
( $V_{OUT} = 2.5V$ , ECO Mode to PWM Mode)

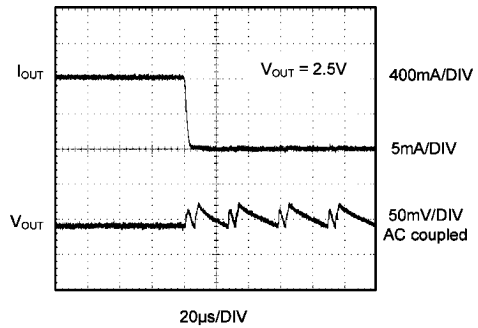

30013453

**Load Transient Reponse**  
( $V_{OUT} = 1.8V$ , FPWM Mode)

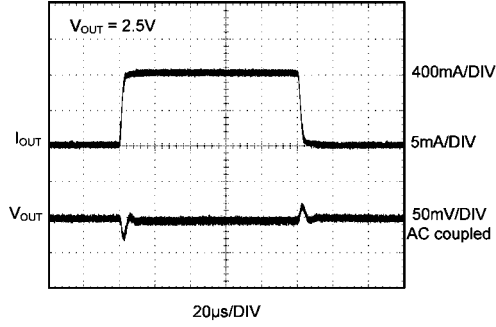

30013490

**Load Transient Reponse**  
( $V_{OUT} = 0.75V$ , PWM Mode)

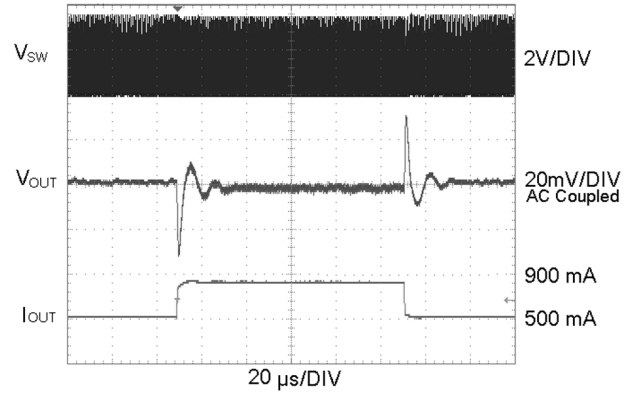

30013491

**Load Transient Reponse**  
( $V_{OUT} = 1.8V$ , PWM Mode)

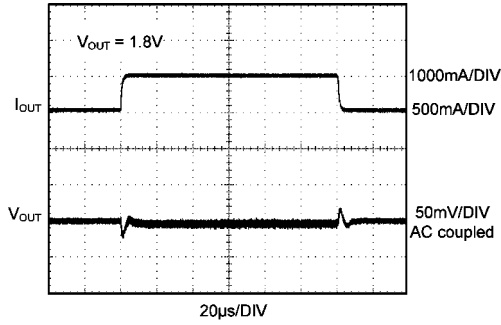

30013492

**Load Transient Reponse**  
( $V_{OUT} = 2.5V$ , PWM Mode)

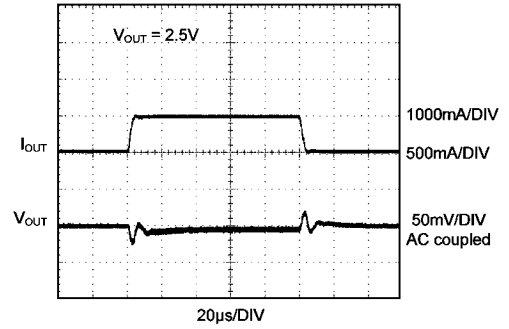

30013446

**Start Up into ECO Mode**  
( $V_{OUT} = 0.75V$ ,  $R_{OUT} = 750\Omega$ )

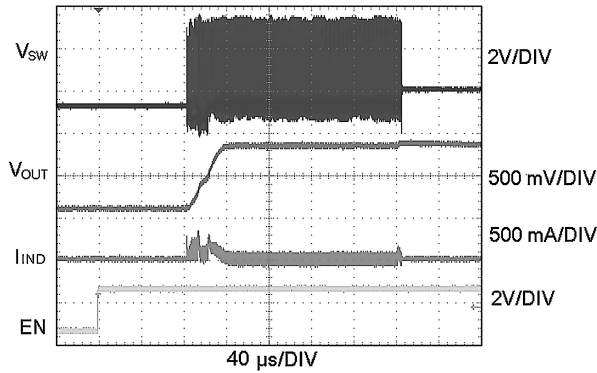

30013495

**Start Up into PWM Mode**  
( $V_{OUT} = 0.75V$ ,  $R_{OUT} = 2.5\Omega$ )

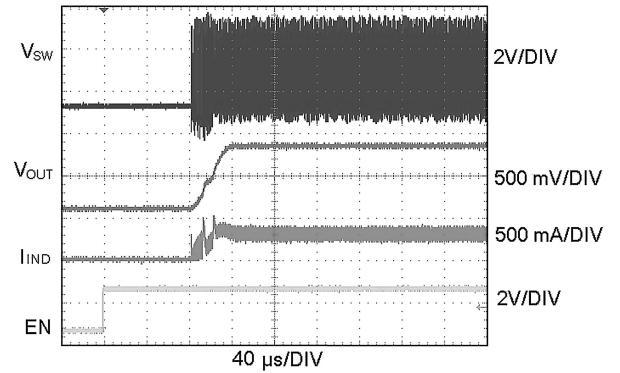

30013496

Start Up into ECO Mode  
( $V_{OUT} = 1.8V$ ,  $R_{OUT} = 1.8 k\Omega$ )

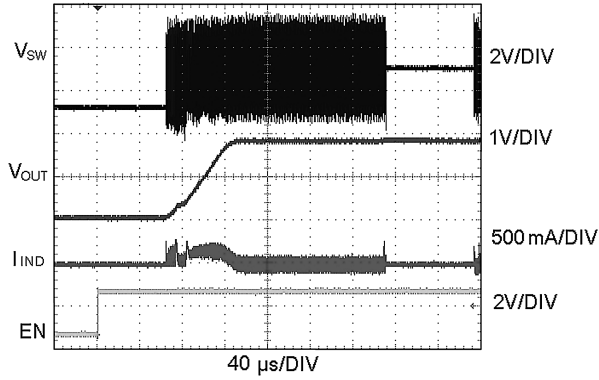

Start Up into PWM Mode  
( $V_{OUT} = 1.8V$ ,  $R_{OUT} = 6\Omega$ )

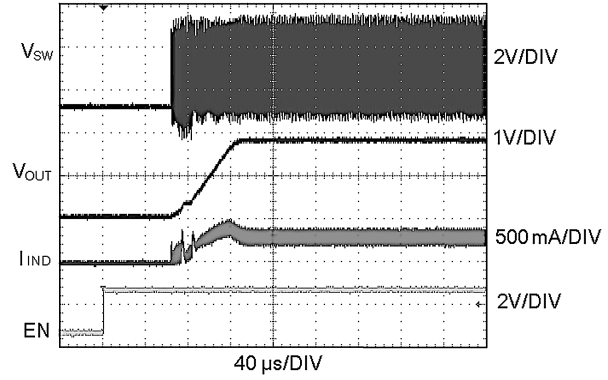

## Operation Description

### DEVICE INFORMATION

The LM3691, a high-efficiency, step-down DC-DC switching buck converter, delivers a constant voltage from either a single Li-Ion or three cell NiMH/NiCd battery to portable devices such as cell phones and PDAs. Using a voltage mode architecture with synchronous rectification, the LM3691 has the ability to deliver up to 1000 mA depending on the input voltage and output voltage, ambient temperature, and the inductor chosen.

There are three modes of operation depending on the current required - PWM (Pulse Width Modulation), ECO, and shutdown. The device operates in PWM mode at load currents of approximately 50 mA (typ.) or higher. Lighter output current loads cause the device to automatically switch into ECO mode for reduced current consumption and a longer battery life. Shutdown mode turns off the device, offering the lowest current consumption ( $I_{SHUTDOWN} = 0.03 \mu\text{A}$  typ.). Additional features include soft-start, under voltage protection, current overload protection, and thermal shutdown protection. As shown in *Figure 1*, only three external power components are required for implementation.

### CIRCUIT OPERATION

The LM3691 operates as follows. During the first portion of each switching cycle, the control block in the LM3691 turns on the internal PFET switch. This allows current to flow from the input through the inductor to the output filter capacitor and load. The inductor limits the current to a ramp with a slope of  $(V_{IN} - V_{OUT})/L$ , by storing energy in a magnetic field. During the second portion of each cycle, the controller turns the PFET switch off, blocking current flow from the input, and then turns the NFET synchronous rectifier on. The inductor draws current from ground through the NFET to the output filter capacitor and load, which ramps the inductor current down with a slope of  $-V_{OUT}/L$ .

The output filter stores charge when the inductor current is high, and releases it when low, smoothing the voltage across the load. The output voltage is regulated by modulating the PFET switch on time to control the average current sent to the load. The effect is identical to sending a duty-cycle modulated rectangular wave formed by the switch and synchronous rectifier at the SW pin to a low-pass filter formed by the inductor and output filter capacitor. The output voltage is equal to the average voltage at the SW pin.

### PWM OPERATION

During PWM operation, the converter operates as a voltage-mode controller with input voltage feed forward. This allows the converter to achieve excellent load and line regulation. The DC gain of the power stage is proportional to the input voltage. To eliminate this dependence, feed forward inversely proportional to the input voltage is introduced. While in PWM mode, the output voltage is regulated by switching at a constant frequency and then modulating the energy per cycle to control power to the load. At the beginning of each clock cycle the PFET switch is turned on and the inductor current ramps up until the comparator trips and the control logic turns off the switch. The current limit comparator can also turn off the switch in case the current limit of the PFET is exceeded. Then the NFET switch is turned on and the inductor current ramps down. The next cycle is initiated by the clock turning off the NFET and turning on the PFET.

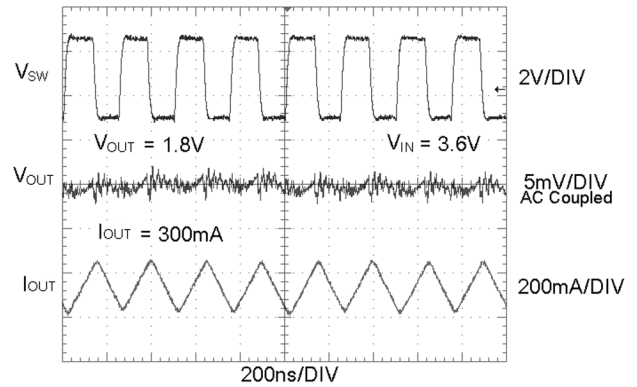

FIGURE 4. Typical PWM Operation

### Internal Synchronous Rectification

While in PWM mode, the LM3691 uses an internal NFET as a synchronous rectifier to reduce rectifier forward voltage drop and associated power loss. Synchronous rectification provides a significant improvement in efficiency whenever the output voltage is relatively low compared to the voltage drop across an ordinary rectifier diode.

### Current Limiting

A current limit feature allows the LM3691 to protect itself and external components during overload conditions. PWM mode implements current limit using an internal comparator that trips at 1500 mA (typ.). If the output is shorted to ground and output voltage becomes lower than 0.3V (typ.), the device enters a timed current limit mode where the switching frequency will be one fourth, and NFET synchronous rectifier is disabled, thereby preventing excess current and thermal runaway.

### ECO OPERATION

Setting mode pin low places the LM3691 in Auto mode. By doing so the part switches from ECO (ECONomy) state to FPWM (Forced Pulse Width Modulation) state based on output load current. At light loads (less than 50 mA), the converter enters ECO mode. In this mode the part operates with low  $I_q$ . During ECO operation, the converter positions the output voltage slightly higher (+30 mV typ.) than the nominal output voltage in FPWM operation. Because the reference is set higher, the output voltage increases to reach the target voltage when the part goes from sleep state to switching state. Once this voltage is reached the converter enters sleep mode, thereby reducing switching losses and improving light load efficiency. The output voltage ripple is slightly higher in ECO mode (30 mV peak-peak ripple typ.).

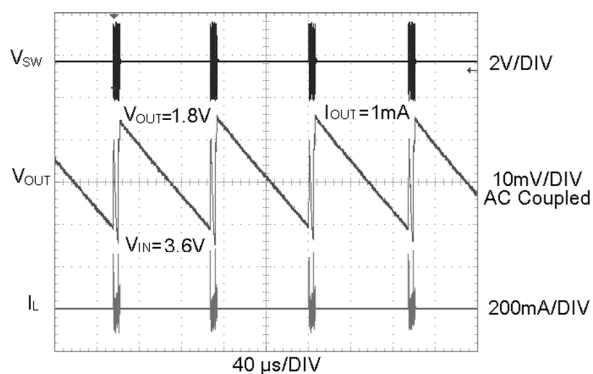

30013498

**FIGURE 5. Typical ECO Operation**

#### FORCED PWM MODE

Setting Mode pin high (>1.2V) places the LM3691 in Forced PWM. The part is in forced PWM regardless of the load.

#### SHUTDOWN MODE

Setting the EN input pin low (<0.4V) places the LM3691 in shutdown mode. During shutdown the PFET switch, NFET

switch, reference, control and bias circuitry of the LM3691 are turned off. Setting EN high (>1.2V) enables normal operation. When turning on the device with EN soft-start is activated. EN pin should be set low to turn off the LM3691 during system power up and under-voltage conditions when the supply is less than 2.3V. Do not leave the EN pin floating.

#### SOFT-START

The LM3691 has a soft-start circuit that limits in-rush current during start-up. Output voltage increase rate is 30 mV/μsec (at  $V_{OUT} = 1.8V$  typ.) during soft-start.

#### THERMAL SHUTDOWN PROTECTION

The LM3691 has a thermal overload protection function that operates to protect itself from short-term misuse and overload conditions. When the junction temperature exceeds around 150°C, the device inhibits operation. Both the PFET and the NFET are turned off. When the temperature drops below 130°C, normal operation resumes. Prolonged operation in thermal overload conditions may damage the device and is considered bad practice.

## Application Information

### INDUCTOR SELECTION

DC bias current characteristics of inductors must be considered. Different manufacturers follow different saturation current rating specifications, so attention must be given to details. DC bias curves should be requested from them as part of the inductor selection process.

**Minimum value of inductance to guarantee good performance is 0.5  $\mu\text{H}$  at 1.5A ( $I_{\text{LIM}}$  typ.) bias current over the ambient temp range.** The inductor's DC resistance should be less than  $0.1\Omega$  for good efficiency at high current condition. The inductor AC loss (resistance) also affects conversion efficiency. Higher Q factor at switching frequency usually gives better efficiency at light load to middle load.

Table 1 lists suggested inductors and suppliers

### INPUT CAPACITOR SELECTION

A ceramic input capacitor of 4.7  $\mu\text{F}$ , 6.3V/10V is sufficient for most applications. Place the input capacitor as close as possible to the  $V_{\text{IN}}$  pin and GND pin of the device. A larger value or higher voltage rating may be used to improve input voltage filtering. Use X7R, X5R or B types; do not use Y5V or F. DC bias characteristics of ceramic capacitors must be considered when selecting case sizes like 0402. **Minimum input capacitance to guarantee good performance is 2.2  $\mu\text{F}$  at maximum input voltage DC bias including tolerances and over ambient temp range.**

The input filter capacitor supplies current to the PFET (high-side) switch in the first half of each cycle and reduces voltage ripple imposed on the input power source. A ceramic capacitor's low ESR provides the best noise filtering of the input voltage spikes due to this rapidly changing current. Select an input filter capacitor with sufficient ripple current rating. The input current ripple can be calculated as:

$$I_{\text{RMS}} = I_{\text{OUTMAX}} \times \sqrt{\frac{V_{\text{OUT}}}{V_{\text{IN}}} \times \left( 1 - \frac{V_{\text{OUT}}}{V_{\text{IN}}} + \frac{r^2}{12} \right)}$$

$$r = \frac{(V_{\text{IN}} - V_{\text{OUT}}) \times V_{\text{OUT}}}{L \times f \times I_{\text{OUTMAX}} \times V_{\text{IN}}}$$

TABLE 1. Suggested Inductors and Their Suppliers

Model	Vendor	Dimensions LxWxH (mm)	D.C.R (m $\Omega$ )
LQM2HPN1R0MG0	Murata	2.5 x 2.0 x 1.0	55
MLP2520S1R0L	TDK	2.5 x 2.0 x 1.0	60
KSLI252010BG1R0	Hltachi Metals	2.5 x 2.0 x 1.0	80
MIPSZ2012D1R0	FDK	2.0 x 1.25 x 1.0	90

TABLE 2. Suggested Capacitors and Their Suppliers

Model	Type	Vendor	Voltage Rating (V)	Case Size Inch (mm)
<b>4.7 <math>\mu\text{F}</math> for <math>C_{\text{IN}}</math> and <math>C_{\text{OUT}}</math></b>				
C1608X5R0J475K	Ceramic	TDK	6.3	0603 (1608)
C1608X5R1A475K	Ceramic	TDK	10.0	0603 (1608)

### OUTPUT CAPACITOR SELECTION

Use a 4.7 $\mu\text{F}$ , 6.3V ceramic capacitor, X7R, X5R or B types; do not use Y5V or F. DC bias voltage characteristics of ceramic capacitors must be considered. DC bias characteristics vary from manufacturer to manufacturer, and DC bias curves should be requested from them as part of the capacitor selection process. The output filter capacitor smooths out current flow from the inductor to the load, helps maintain a steady output voltage during transient load changes and reduces output voltage ripple. These capacitors must be selected with sufficient capacitance and sufficiently low ESR to perform these functions. **Minimum output capacitance to guarantee good performance is 2.2  $\mu\text{F}$  at the output voltage DC bias including tolerances and over ambient temp range.**

The output voltage ripple is caused by the charging and discharging of the output capacitor and also due to its  $R_{\text{ESR}}$  and can be calculated as:

Voltage peak-to-peak ripple due to capacitance =

$$V_{\text{PP-C}} = \frac{I_{\text{RIPPLE}}}{4 * f * C}$$

Voltage peak-to-peak ripple due to ESR =

$$V_{\text{PP-ESR}} = (2 * I_{\text{RIPPLE}}) * R_{\text{ESR}}$$

Because these two components are out of phase the rms value can be used to get an approximate value of peak-to-peak ripple.

Voltage peak-to-peak ripple, root mean squared =

$$V_{\text{PP-RMS}} = \sqrt{V_{\text{PP-C}}^2 + V_{\text{PP-ESR}}^2}$$

Note that the output voltage ripple is dependent on the current ripple and the equivalent series resistance of the output capacitor ( $R_{\text{ESR}}$ ). The  $R_{\text{ESR}}$  is frequency dependent (as well as temperature dependent); make sure the value used for calculations is at the switching frequency of the part.

Table 2 lists suggested capacitors and suppliers.



#### MICRO SMD PACKAGE ASSEMBLY AND USE

Use of the Micro SMD package requires specialized board layout, precision mounting and careful re-flow techniques, as detailed in National Semiconductor Application Note 1112. Refer to the section *Surface Mount Technology (SMD) Assembly Considerations*. For best results in assembly, alignment ordinals on the PC board should be used to facilitate placement of the device. The pad style used with micro SMD package must be the NSMD (Non-Solder Mask Defined) type. This means that the solder-mask opening is larger than the pad size. This prevents a lip that otherwise forms if the solder-mask and pad overlap, from holding the device off the surface of the board and interfering with mounting. See Application Note 1112 for specific instructions how to do this.

The 6-bump package used for LM3691 has 300-micron solder balls and requires 10.82 mils pads for mounting on the circuit board. The trace to each pad should enter the pad with a 90° entry angle to prevent debris from being caught in deep

corners. Initially, the trace to each pad should be 7 mil wide, for a section approximately 7 mil long or longer, as a thermal relief. Then each trace should neck up or down to its optimal width. The important criteria is symmetry. This ensures the solder bumps on the LM3691 re-flow evenly and that the device solders level to the board. In particular, special attention must be paid to the pads for bumps A2 and C2, because GND and  $V_{IN}$  are typically connected to large copper planes.

The micro SMD package is optimized for the smallest possible size in applications with red or infrared opaque cases. Because the micro SMD package lacks the plastic encapsulation characteristic of larger devices, it is vulnerable to light. Backside metallization and/or epoxy coating, along with front side shading by the printed circuit board, reduce this sensitivity. However, the package has exposed die edges. In particular, micro SMD devices are sensitive to light, in the red and infrared range, shining on the package's exposed die edges.

**Physical Dimensions** inches (millimeters) unless otherwise noted

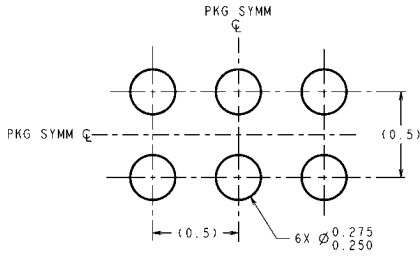

DIMENSIONS ARE IN MILLIMETERS  
 DIMENSIONS IN ( ) FOR REFERENCE ONLY

**LAND PATTERN RECOMMENDATION**

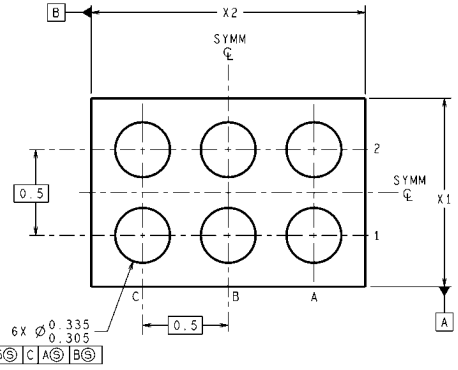
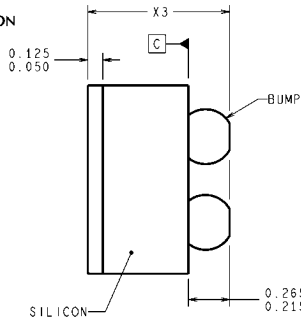
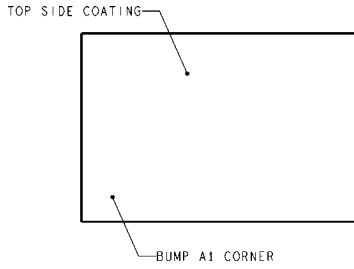

⊕ 0.005 C | A | B

TLA06XXX (Rev C)

6-bump Thin Micro SMD, Large Bump  
 NS Package Number TLA06LCA  
 X1 = 1.260 mm ± 0.030 mm  
 X2 = 1.565 mm ± 0.030 mm  
 X3 = 0.600 mm ± 0.075 mm



## Notes

For more National Semiconductor product information and proven design tools, visit the following Web sites at:

Products		Design Support	
Amplifiers	<a href="http://www.national.com/amplifiers">www.national.com/amplifiers</a>	WEBENCH® Tools	<a href="http://www.national.com/webench">www.national.com/webench</a>
Audio	<a href="http://www.national.com/audio">www.national.com/audio</a>	App Notes	<a href="http://www.national.com/appnotes">www.national.com/appnotes</a>
Clock and Timing	<a href="http://www.national.com/timing">www.national.com/timing</a>	Reference Designs	<a href="http://www.national.com/refdesigns">www.national.com/refdesigns</a>
Data Converters	<a href="http://www.national.com/adc">www.national.com/adc</a>	Samples	<a href="http://www.national.com/samples">www.national.com/samples</a>
Interface	<a href="http://www.national.com/interface">www.national.com/interface</a>	Eval Boards	<a href="http://www.national.com/evalboards">www.national.com/evalboards</a>
LVDS	<a href="http://www.national.com/lvds">www.national.com/lvds</a>	Packaging	<a href="http://www.national.com/packaging">www.national.com/packaging</a>
Power Management	<a href="http://www.national.com/power">www.national.com/power</a>	Green Compliance	<a href="http://www.national.com/quality/green">www.national.com/quality/green</a>
Switching Regulators	<a href="http://www.national.com/switchers">www.national.com/switchers</a>	Distributors	<a href="http://www.national.com/contacts">www.national.com/contacts</a>
LDOs	<a href="http://www.national.com/ldo">www.national.com/ldo</a>	Quality and Reliability	<a href="http://www.national.com/quality">www.national.com/quality</a>
LED Lighting	<a href="http://www.national.com/led">www.national.com/led</a>	Feedback/Support	<a href="http://www.national.com/feedback">www.national.com/feedback</a>
Voltage Reference	<a href="http://www.national.com/vref">www.national.com/vref</a>	Design Made Easy	<a href="http://www.national.com/easy">www.national.com/easy</a>
PowerWise® Solutions	<a href="http://www.national.com/powerwise">www.national.com/powerwise</a>	Solutions	<a href="http://www.national.com/solutions">www.national.com/solutions</a>
Serial Digital Interface (SDI)	<a href="http://www.national.com/sdi">www.national.com/sdi</a>	Mil/Aero	<a href="http://www.national.com/milaero">www.national.com/milaero</a>
Temperature Sensors	<a href="http://www.national.com/tempsensors">www.national.com/tempsensors</a>	Solar Magic®	<a href="http://www.national.com/solarmagic">www.national.com/solarmagic</a>
Wireless (PLL/VCO)	<a href="http://www.national.com/wireless">www.national.com/wireless</a>	Analog University®	<a href="http://www.national.com/AU">www.national.com/AU</a>

THE CONTENTS OF THIS DOCUMENT ARE PROVIDED IN CONNECTION WITH NATIONAL SEMICONDUCTOR CORPORATION ("NATIONAL") PRODUCTS. NATIONAL MAKES NO REPRESENTATIONS OR WARRANTIES WITH RESPECT TO THE ACCURACY OR COMPLETENESS OF THE CONTENTS OF THIS PUBLICATION AND RESERVES THE RIGHT TO MAKE CHANGES TO SPECIFICATIONS AND PRODUCT DESCRIPTIONS AT ANY TIME WITHOUT NOTICE. NO LICENSE, WHETHER EXPRESS, IMPLIED, ARISING BY ESTOPPEL OR OTHERWISE, TO ANY INTELLECTUAL PROPERTY RIGHTS IS GRANTED BY THIS DOCUMENT.

TESTING AND OTHER QUALITY CONTROLS ARE USED TO THE EXTENT NATIONAL DEEMS NECESSARY TO SUPPORT NATIONAL'S PRODUCT WARRANTY. EXCEPT WHERE MANDATED BY GOVERNMENT REQUIREMENTS, TESTING OF ALL PARAMETERS OF EACH PRODUCT IS NOT NECESSARILY PERFORMED. NATIONAL ASSUMES NO LIABILITY FOR APPLICATIONS ASSISTANCE OR BUYER PRODUCT DESIGN. BUYERS ARE RESPONSIBLE FOR THEIR PRODUCTS AND APPLICATIONS USING NATIONAL COMPONENTS. PRIOR TO USING OR DISTRIBUTING ANY PRODUCTS THAT INCLUDE NATIONAL COMPONENTS, BUYERS SHOULD PROVIDE ADEQUATE DESIGN, TESTING AND OPERATING SAFEGUARDS.

EXCEPT AS PROVIDED IN NATIONAL'S TERMS AND CONDITIONS OF SALE FOR SUCH PRODUCTS, NATIONAL ASSUMES NO LIABILITY WHATSOEVER, AND NATIONAL DISCLAIMS ANY EXPRESS OR IMPLIED WARRANTY RELATING TO THE SALE AND/OR USE OF NATIONAL PRODUCTS INCLUDING LIABILITY OR WARRANTIES RELATING TO FITNESS FOR A PARTICULAR PURPOSE, MERCHANTABILITY, OR INFRINGEMENT OF ANY PATENT, COPYRIGHT OR OTHER INTELLECTUAL PROPERTY RIGHT.

### LIFE SUPPORT POLICY

**NATIONAL'S PRODUCTS ARE NOT AUTHORIZED FOR USE AS CRITICAL COMPONENTS IN LIFE SUPPORT DEVICES OR SYSTEMS WITHOUT THE EXPRESS PRIOR WRITTEN APPROVAL OF THE CHIEF EXECUTIVE OFFICER AND GENERAL COUNSEL OF NATIONAL SEMICONDUCTOR CORPORATION.** As used herein:

Life support devices or systems are devices which (a) are intended for surgical implant into the body, or (b) support or sustain life and whose failure to perform when properly used in accordance with instructions for use provided in the labeling can be reasonably expected to result in a significant injury to the user. A critical component is any component in a life support device or system whose failure to perform can be reasonably expected to cause the failure of the life support device or system or to affect its safety or effectiveness.

National Semiconductor and the National Semiconductor logo are registered trademarks of National Semiconductor Corporation. All other brand or product names may be trademarks or registered trademarks of their respective holders.

Copyright© 2009 National Semiconductor Corporation

For the most current product information visit us at [www.national.com](http://www.national.com)



**National Semiconductor  
Americas Technical  
Support Center**  
Email: [support@nsc.com](mailto:support@nsc.com)  
Tel: 1-800-272-9959

**National Semiconductor Europe  
Technical Support Center**  
Email: [europe.support@nsc.com](mailto:europe.support@nsc.com)  
German Tel: +49 (0) 180 5010 771  
English Tel: +44 (0) 870 850 4288

**National Semiconductor Asia  
Pacific Technical Support Center**  
Email: [ap.support@nsc.com](mailto:ap.support@nsc.com)

**National Semiconductor Japan  
Technical Support Center**  
Email: [jpn.feedback@nsc.com](mailto:jpn.feedback@nsc.com)