

## Rectifier diodes fast, soft-recovery

## BY329F, BY329X series

### FEATURES

- Low forward volt drop
- Fast switching
- Soft recovery characteristic
- High thermal cycling performance
- Isolated mounting tab

### SYMBOL

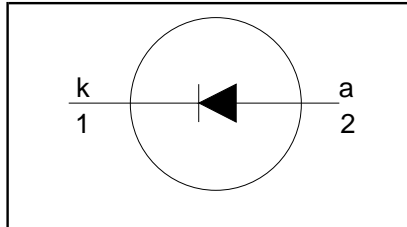

### QUICK REFERENCE DATA

$$V_R = 800 \text{ V} / 1000 \text{ V} / 1200 \text{ V}$$

$$I_{F(AV)} = 8 \text{ A}$$

$$I_{FSM} \leq 65 \text{ A}$$

$$t_{rr} \leq 145 \text{ ns}$$

### GENERAL DESCRIPTION

Glass-passivated double diffused rectifier diodes featuring low forward voltage drop, fast reverse recovery and soft recovery characteristic. The devices are intended for use in TV receivers, monitors and switched mode power supplies.

The BY329F series is supplied in the conventional leaded SOD100 package.  
The BY329X series is supplied in the conventional leaded SOD113 package.

### PINNING

PIN	DESCRIPTION
1	cathode
2	anode
tab	isolated

### SOD100

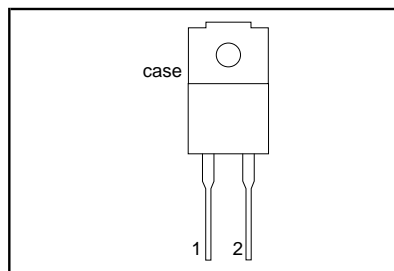

### SOD113

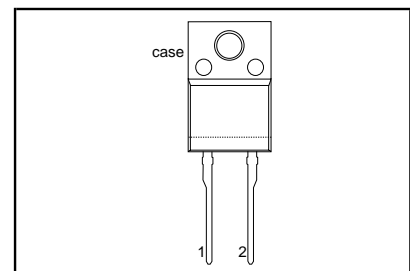

### LIMITING VALUES

Limiting values in accordance with the Absolute Maximum System (IEC 134).

SYMBOL	PARAMETER	CONDITIONS	MIN.	MAX.			UNIT
				-800	-1000	-1200	
$V_{RSM}$	Peak non-repetitive reverse voltage	<b>BY329F / BY329X</b>	-	800	1000	1200	V
$V_{RRM}$	Peak repetitive reverse voltage		-	800	1000	1200	V
$V_{RWM}$	Crest working reverse voltage		-	600	800	1000	V
$I_{F(AV)}$	Average forward current <sup>1</sup>	square wave; $\delta = 0.5$ ; $T_{hs} \leq 83^\circ\text{C}$ sinusoidal; $a = 1.57$ ; $T_{hs} \leq 90^\circ\text{C}$	-	8			A
$I_{F(RMS)}$	RMS forward current		-	11			A
$I_{FRM}$	Peak repetitive forward current	$t = 25 \mu\text{s}$ ; $\delta = 0.5$ ; $T_{hs} \leq 83^\circ\text{C}$	-	16			A
$I_{FSM}$	Peak non-repetitive forward current.	$t = 10 \text{ ms}$ $t = 8.3 \text{ ms}$ sinusoidal; $T_j = 150^\circ\text{C}$ prior to surge; with reapplied	-	65			A
		$V_{RWM(max)}$	-	71			A
$I^2t$	$I^2t$ for fusing	$t = 10 \text{ ms}$	-	28			A <sup>2</sup> s
$T_{sig}$	Storage temperature		-40	150			°C
$T_j$	Operating junction temperature		-	150			°C

1. Neglecting switching and reverse current losses.

**Rectifier diodes  
fast, soft-recovery**
**BY329F, BY329X series**
**ISOLATION LIMITING VALUE & CHARACTERISTIC**
 $T_{hs} = 25\text{ }^{\circ}\text{C}$  unless otherwise specified

SYMBOL	PARAMETER	CONDITIONS	MIN.	TYP.	MAX.	UNIT
$V_{isol}$	Peak isolation voltage from both terminals to external heatsink	SOD100 package; R.H. $\leq$ 65%; clean and dustfree	-	-	1500	V
$V_{isol}$	R.M.S. isolation voltage from both terminals to external heatsink	SOD113 package; $f = 50\text{-}60\text{ Hz}$ ; sinusoidal waveform; R.H. $\leq$ 65%; clean and dustfree	-	-	2500	V
$C_{isol}$	Capacitance from pin 1 to external heatsink	$f = 1\text{ MHz}$	-	10	-	pF

**THERMAL RESISTANCES**

SYMBOL	PARAMETER	CONDITIONS	MIN.	TYP.	MAX.	UNIT
$R_{th\ j\text{-}hs}$	Thermal resistance junction to heatsink	with heatsink compound	-	-	4.8	K/W
$R_{th\ j\text{-}a}$	Thermal resistance junction to ambient	without heatsink compound in free air.	-	55	5.9	K/W

**STATIC CHARACTERISTICS**
 $T_j = 25\text{ }^{\circ}\text{C}$  unless otherwise stated

SYMBOL	PARAMETER	CONDITIONS	MIN.	TYP.	MAX.	UNIT
$V_F$	Forward voltage	$I_F = 20\text{ A}$	-	1.5	1.85	V
$I_R$	Reverse current	$V_R = V_{RWM}$ ; $T_j = 125\text{ }^{\circ}\text{C}$	-	0.1	1.0	mA

**DYNAMIC CHARACTERISTICS**
 $T_j = 25\text{ }^{\circ}\text{C}$  unless otherwise stated

SYMBOL	PARAMETER	CONDITIONS	MIN.	TYP.	MAX.	UNIT
$t_{rr}$	Reverse recovery time	$I_F = 1\text{ A}$ ; $V_R \geq 30\text{ V}$ ; $-di_F/dt = 50\text{ A}/\mu\text{s}$	-	125	145	ns
$Q_s$	Reverse recovery charge	$I_F = 2\text{ A}$ ; $V_R \geq 30\text{ V}$ ; $-di_F/dt = 20\text{ A}/\mu\text{s}$	-	0.5	0.7	$\mu\text{C}$
$di_R/dt$	Maximum slope of the reverse recovery current	$I_F = 2\text{ A}$ ; $-di_F/dt = 20\text{ A}/\mu\text{s}$	-	50	60	$\text{A}/\mu\text{s}$

Rectifier diodes  
fast, soft-recovery

BY329F, BY329X series

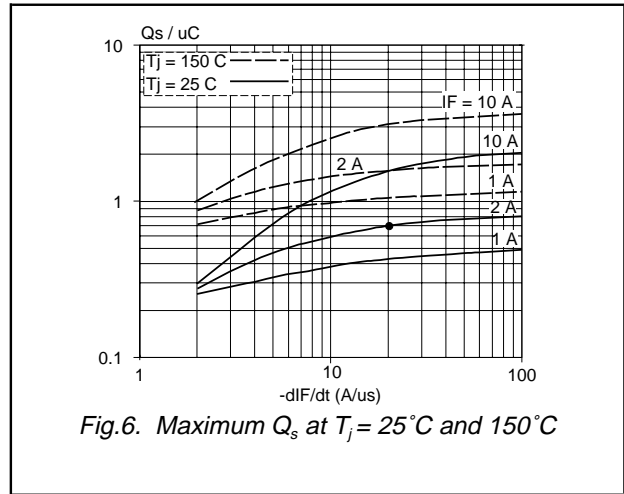
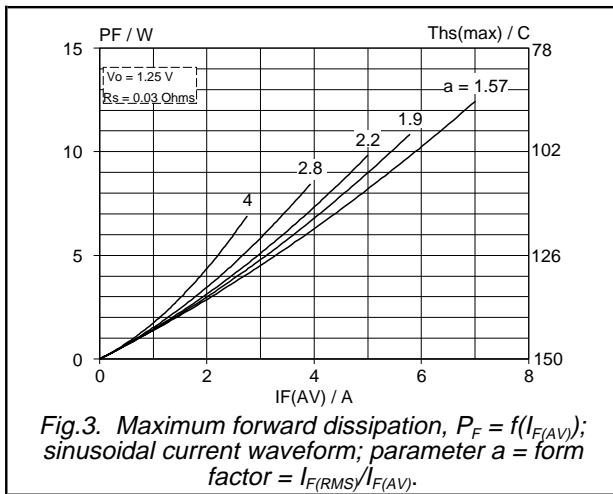
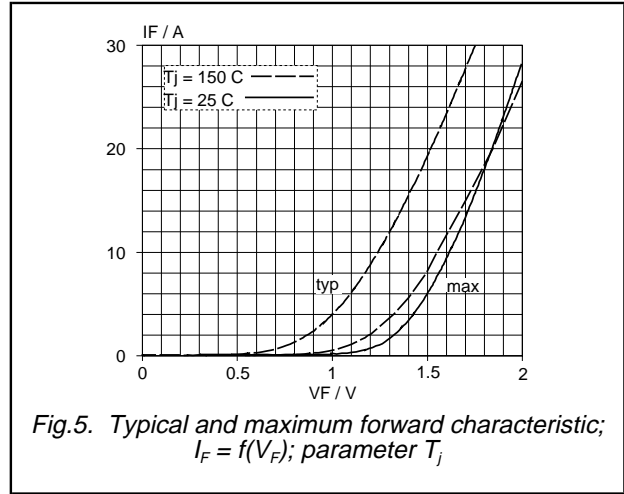
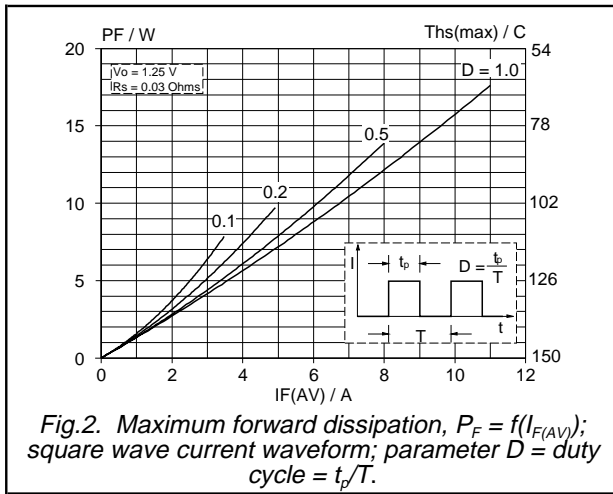
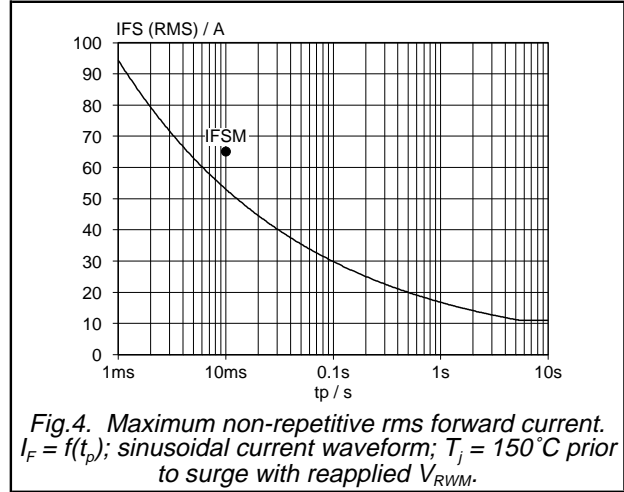
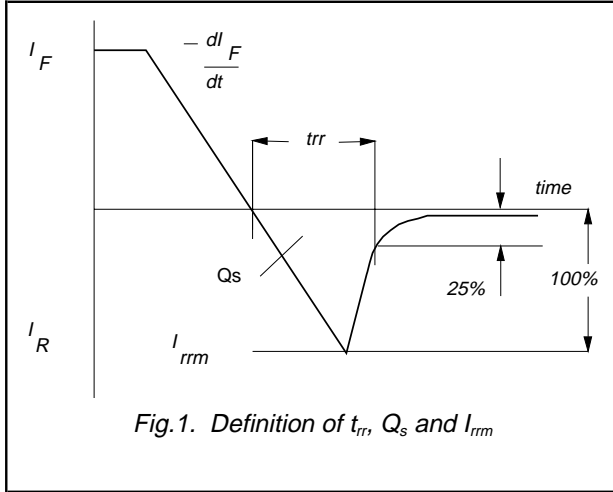

Rectifier diodes  
fast, soft-recovery

BY329F, BY329X series

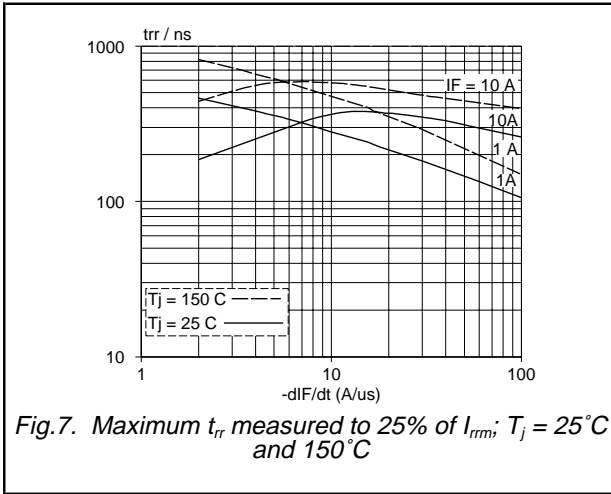

Fig.7. Maximum  $t_{rr}$  measured to 25% of  $I_{rrm}$ ;  $T_j = 25^\circ\text{C}$  and  $150^\circ\text{C}$

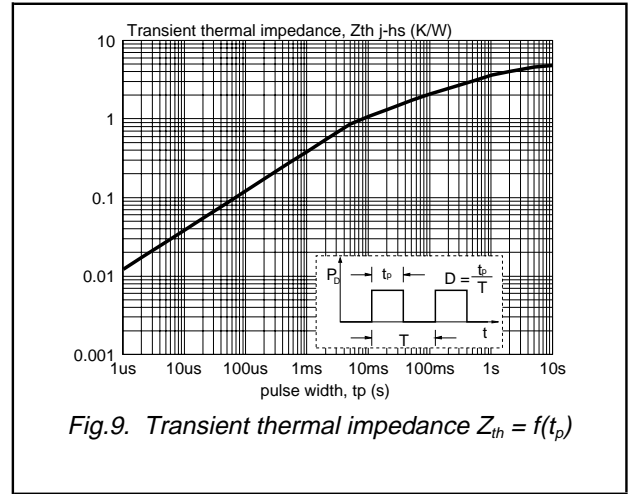

Fig.9. Transient thermal impedance  $Z_{th} = f(t_p)$

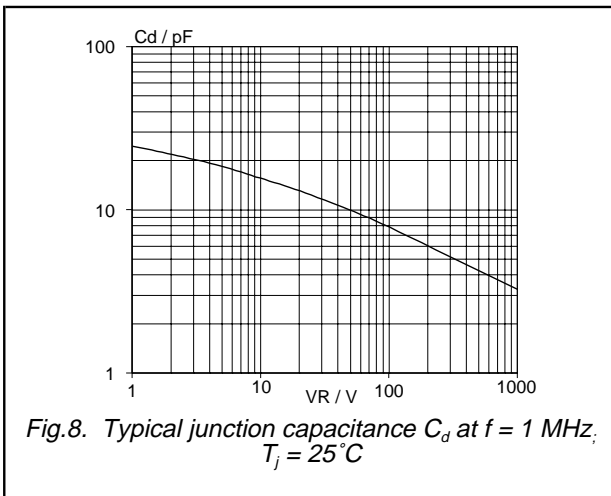

Fig.8. Typical junction capacitance  $C_d$  at  $f = 1\text{ MHz}$ ;  $T_j = 25^\circ\text{C}$

Rectifier diodes  
fast, soft-recovery

BY329F, BY329X series

**MECHANICAL DATA**

Dimensions in mm

Net Mass: 2 g

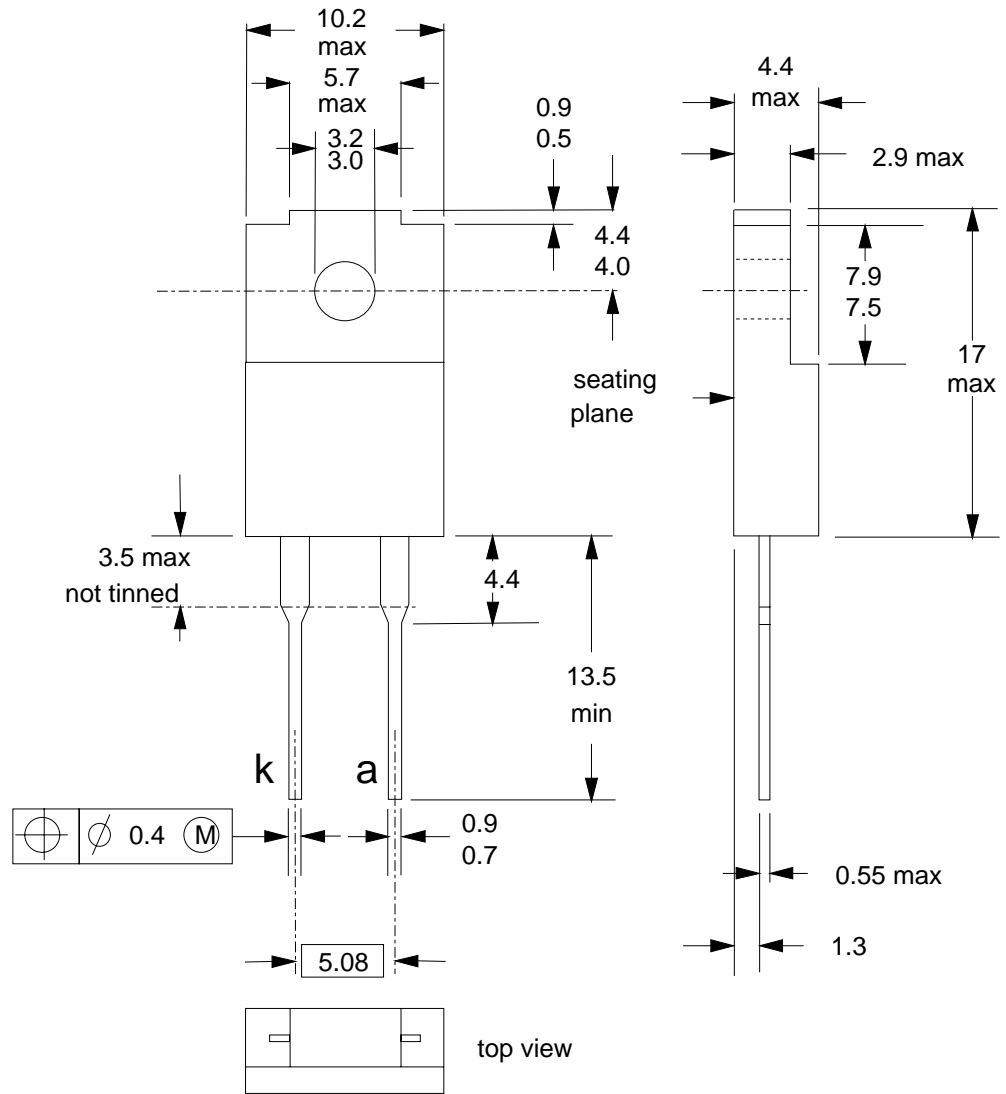

Fig.10. SOD100; The seating plane is electrically isolated from all terminals.

**Notes**

1. Refer to mounting instructions for F-pack envelopes.
2. Epoxy meets UL94 V0 at 1/8".

Rectifier diodes  
fast, soft-recovery

BY329F, BY329X series

**MECHANICAL DATA**

Dimensions in mm

Net Mass: 2 g

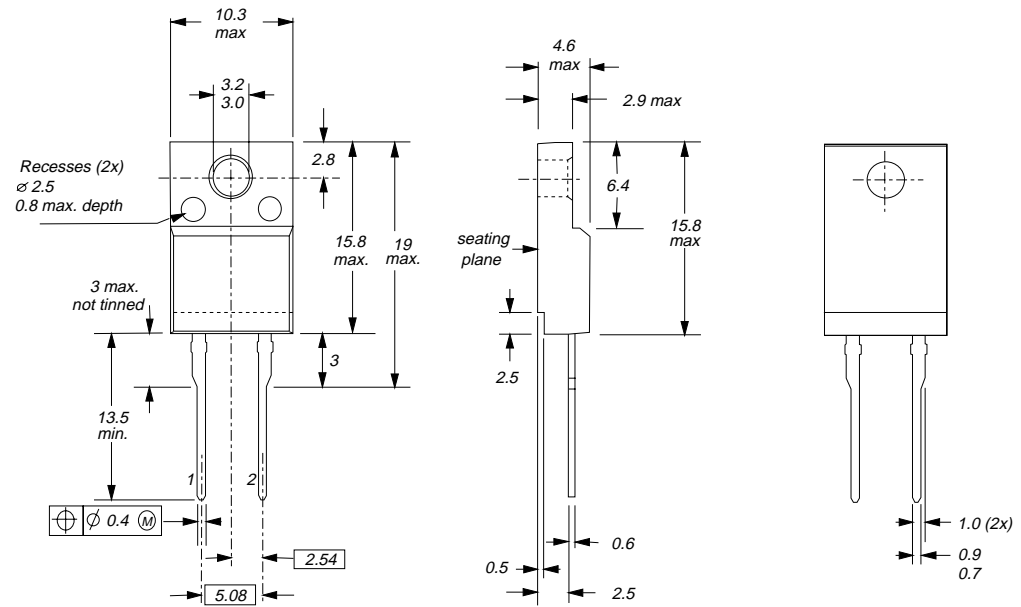

Fig.11. SOD113; The seating plane is electrically isolated from all terminals.

**Notes**

1. Refer to mounting instructions for F-pack envelopes.
2. Epoxy meets UL94 V0 at 1/8".

**Rectifier diodes  
fast, soft-recovery**
**BY329F, BY329X series**
**DEFINITIONS**

<b>Data sheet status</b>	
Objective specification	This data sheet contains target or goal specifications for product development.
Preliminary specification	This data sheet contains preliminary data; supplementary data may be published later.
Product specification	This data sheet contains final product specifications.
<b>Limiting values</b>	
Limiting values are given in accordance with the Absolute Maximum Rating System (IEC 134). Stress above one or more of the limiting values may cause permanent damage to the device. These are stress ratings only and operation of the device at these or at any other conditions above those given in the Characteristics sections of this specification is not implied. Exposure to limiting values for extended periods may affect device reliability.	
<b>Application information</b>	
Where application information is given, it is advisory and does not form part of the specification.	
© <b>Philips Electronics N.V. 1998</b>	
All rights are reserved. Reproduction in whole or in part is prohibited without the prior written consent of the copyright owner.	
The information presented in this document does not form part of any quotation or contract, it is believed to be accurate and reliable and may be changed without notice. No liability will be accepted by the publisher for any consequence of its use. Publication thereof does not convey nor imply any license under patent or other industrial or intellectual property rights.	

**LIFE SUPPORT APPLICATIONS**

These products are not designed for use in life support appliances, devices or systems where malfunction of these products can be reasonably expected to result in personal injury. Philips customers using or selling these products for use in such applications do so at their own risk and agree to fully indemnify Philips for any damages resulting from such improper use or sale.