

# LM3410

## 525kHz/1.6MHz, Constant Current Boost and SEPIC LED Driver with Internal Compensation

### General Description

The LM3410 constant current LED driver is a monolithic, high frequency, PWM step-up DC/DC converter in 5-pin SOT23, 6-pin LLP, & 8-pin eMSOP packages. With a minimum of external components the LM3410 is easy to use. It can drive 2.5A typical peak currents with an internal 160mΩ NMOS switch. Switching frequency is internally set to either 525kHz or 1.60MHz, allowing the use of extremely small surface mount inductors and chip capacitors. Even though the operating frequency is high, efficiencies up to 88% are easy to achieve. External shutdown is included, featuring an ultra-low stand-by current of 80nA. The LM3410 utilizes current-mode control and internal compensation to provide high-performance over a wide range of operating conditions. Additional features include dimming, pulse-by-pulse current limit, and thermal shutdown.

### Features

- Space Saving SOT23-5 & 6-LLP Package
- Wide Input voltage range of 2.7V to 5.5V
- Wide Output voltage range of 3V to 24V
- 2.1A switch current over full temperature range
- Two High Switching Frequencies Available:
  - 525 kHz (LM3410-Y)
  - 1.6 MHz (LM3410-X)
- 160 mΩ NMOS Switch
- 190 mV Internal Voltage Reference
- Internal Soft-Start
- Current-Mode, PWM Operation

### Applications

- Portable Illumination
- LED Backlight Current Source
- Lilon Backlight OLED Driver
- Handheld Devices

### Typical Boost Application Circuit

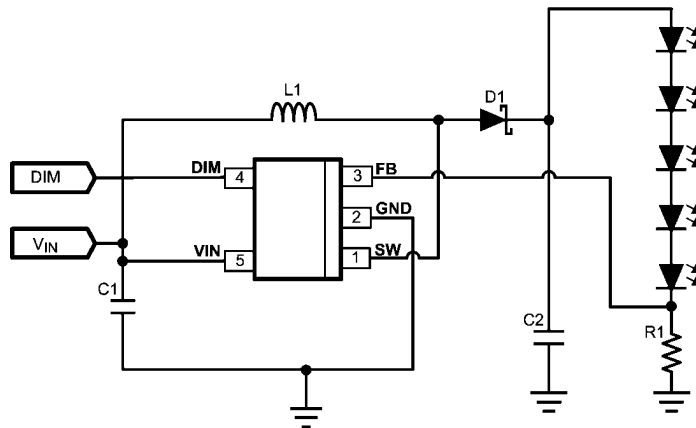

## Connection Diagrams

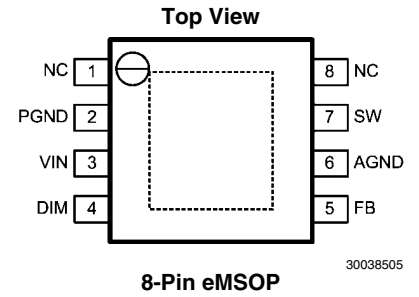
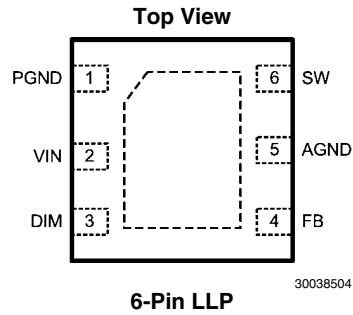
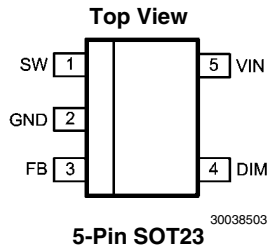

## Ordering Information

Frequency	Order Number	Package Type	Package Drawing	Supplied As
525 kHz	LM3410YMF	SOT23-5	MF05A	1000 units tape & reel
	LM3410YMF <sub>X</sub>			3000 units tape & reel
	LM3410YSD	LLP-6	SDE06A	1000 units tape & reel
	LM3410YSD <sub>X</sub>			4500 units tape & reel
	LM3410YMY	eMSOP-8	MUJ08A	1000 units tape & reel
	LM3410YMY <sub>X</sub>			3500 units tape & reel
1.6 MHz	LM3410XMF	SOT23-5	MF05A	1000 units tape & reel
	LM3410XMF <sub>X</sub>			3000 units tape & reel
	LM3410XSD	LLP-6	SDE06A	1000 units tape & reel
	LM3410XSD <sub>X</sub>			4500 units tape & reel
	LM3410XMY	eMSOP-8	MUJ08A	1000 units tape & reel
	LM3410XMY <sub>X</sub>			3500 units tape & reel

## Pin Description - 5-Pin SOT23

Pin	Name	Function
1	SW	Output switch. Connect to the inductor, output diode.
2	GND	Signal and power ground pin. Place the bottom resistor of the feedback network as close as possible to this pin.
3	FB	Feedback pin. Connect FB to external resistor divider to set output voltage.
4	DIM	Dimming & shutdown control input. Logic high enables operation. Duty Cycle from 0 to 100%. Do not allow this pin to float or be greater than VIN + 0.3V.
5	VIN	Supply voltage for power stage, and input supply voltage.

## Pin Description - 6 Pin LLP

Pin	Name	Function
1	PGND	Power ground pin. Place PGND and output capacitor GND close together.
2	VIN	Supply voltage for power stage, and input supply voltage.
3	DIM	Dimming & shutdown control input. Logic high enables operation. Duty Cycle from 0 to 100%. Do not allow this pin to float or be greater than VIN + 0.3V.
4	FB	Feedback pin. Connect FB to external resistor divider to set output voltage.
5	AGND	Signal ground pin. Place the bottom resistor of the feedback network as close as possible to this pin & pin 4.
6	SW	Output switch. Connect to the inductor, output diode.
DAP	GND	Signal & Power ground. Connect to pin 1 & pin 5 on top layer. Place 4-6 vias from DAP to bottom layer GND plane.

## Pin Description - 8 Pin eMSOP

Pin	Name	Function
1	-	No Connect
2	PGND	Power ground pin. Place PGND and output capacitor GND close together.
3	VIN	Supply voltage for power stage, and input supply voltage.
4	DIM	Dimming & shutdown control input. Logic high enables operation. Duty Cycle from 0 to 100%. Do not allow this pin to float or be greater than VIN + 0.3V.
5	FB	Feedback pin. Connect FB to external resistor divider to set output voltage.
6	AGND	Signal ground pin. Place the bottom resistor of the feedback network as close as possible to this pin & pin 5
7	SW	Output switch. Connect to the inductor, output diode.
8	-	No Connect
DAP	GND	Signal & Power ground. Connect to pin 2 & pin 6 on top layer. Place 4-6 vias from DAP to bottom layer GND plane.

**Physical Dimensions** inches (millimeters) unless otherwise noted

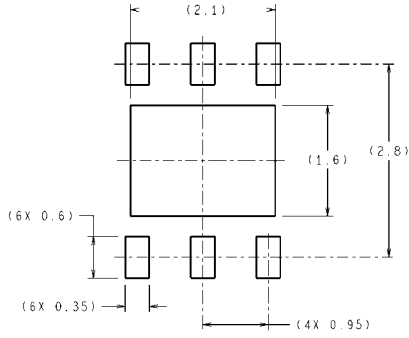

RECOMMENDED LAND PATTERN

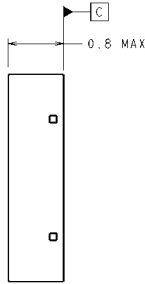
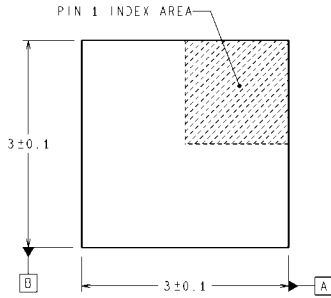

DIMENSIONS ARE IN MILLIMETERS  
DIMENSION IN ( ) FOR REFERENCE ONLY

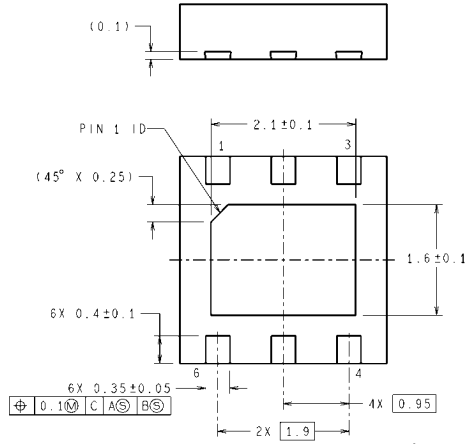

SDE06A (Rev A)

**6-Lead LLP Package**  
**NS Package Number SDE06A**

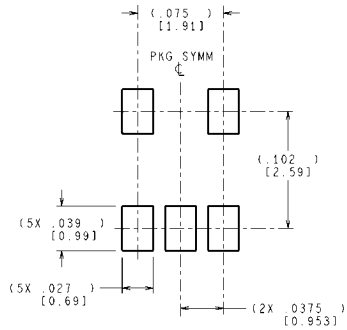
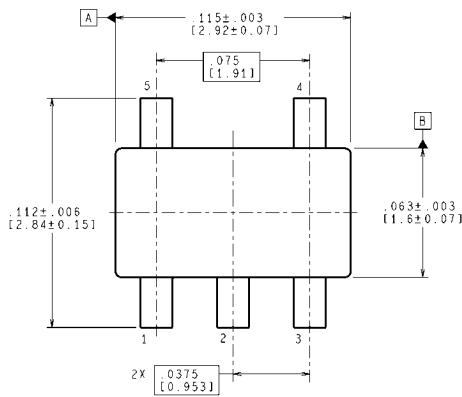

LAND PATTERN RECOMMENDATION

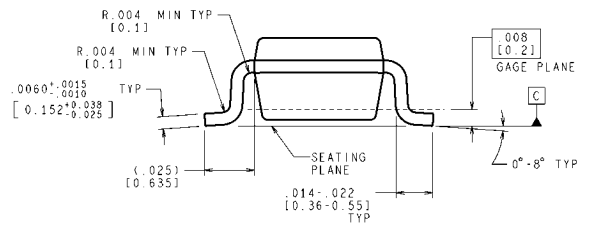
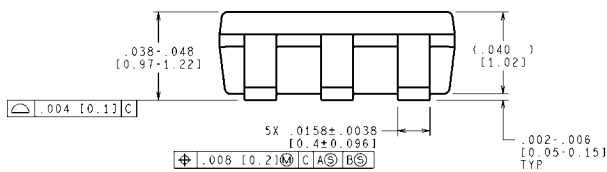

CONTROLLING DIMENSION IS INCH  
VALUES IN [ ] ARE MILLIMETERS  
DIMENSIONS IN ( ) FOR REFERENCE ONLY

**5-Lead SOT23-5 Package**  
**NS Package Number MF05A**

MF05A (Rev C)

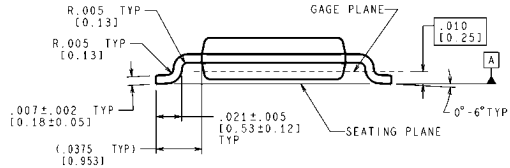
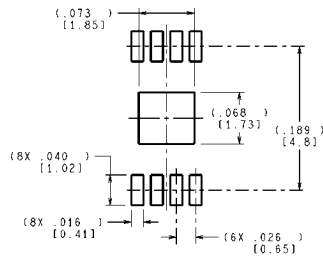
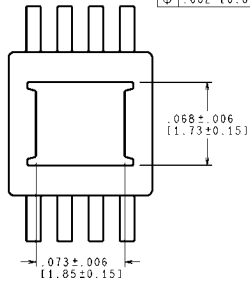
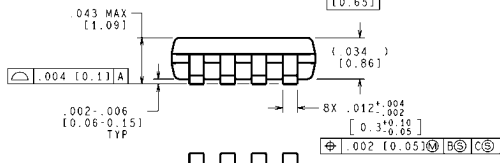
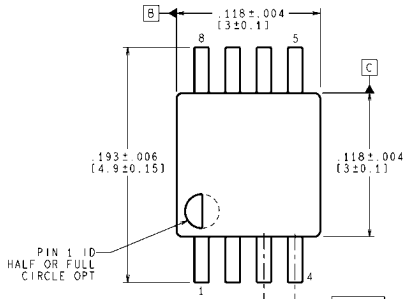

CONTROLLING DIMENSION IS INCH  
VALUES IN [ ] ARE MILLIMETERS

**8-Lead eMSOP Package**  
**NS Package Number MUY08A**

MUY08A (Rev A)

## Notes

THE CONTENTS OF THIS DOCUMENT ARE PROVIDED IN CONNECTION WITH NATIONAL SEMICONDUCTOR CORPORATION ("NATIONAL") PRODUCTS. NATIONAL MAKES NO REPRESENTATIONS OR WARRANTIES WITH RESPECT TO THE ACCURACY OR COMPLETENESS OF THE CONTENTS OF THIS PUBLICATION AND RESERVES THE RIGHT TO MAKE CHANGES TO SPECIFICATIONS AND PRODUCT DESCRIPTIONS AT ANY TIME WITHOUT NOTICE. NO LICENSE, WHETHER EXPRESS, IMPLIED, ARISING BY ESTOPPEL OR OTHERWISE, TO ANY INTELLECTUAL PROPERTY RIGHTS IS GRANTED BY THIS DOCUMENT.

TESTING AND OTHER QUALITY CONTROLS ARE USED TO THE EXTENT NATIONAL DEEMS NECESSARY TO SUPPORT NATIONAL'S PRODUCT WARRANTY. EXCEPT WHERE MANDATED BY GOVERNMENT REQUIREMENTS, TESTING OF ALL PARAMETERS OF EACH PRODUCT IS NOT NECESSARILY PERFORMED. NATIONAL ASSUMES NO LIABILITY FOR APPLICATIONS ASSISTANCE OR BUYER PRODUCT DESIGN. BUYERS ARE RESPONSIBLE FOR THEIR PRODUCTS AND APPLICATIONS USING NATIONAL COMPONENTS. PRIOR TO USING OR DISTRIBUTING ANY PRODUCTS THAT INCLUDE NATIONAL COMPONENTS, BUYERS SHOULD PROVIDE ADEQUATE DESIGN, TESTING AND OPERATING SAFEGUARDS.

EXCEPT AS PROVIDED IN NATIONAL'S TERMS AND CONDITIONS OF SALE FOR SUCH PRODUCTS, NATIONAL ASSUMES NO LIABILITY WHATSOEVER, AND NATIONAL DISCLAIMS ANY EXPRESS OR IMPLIED WARRANTY RELATING TO THE SALE AND/OR USE OF NATIONAL PRODUCTS INCLUDING LIABILITY OR WARRANTIES RELATING TO FITNESS FOR A PARTICULAR PURPOSE, MERCHANTABILITY, OR INFRINGEMENT OF ANY PATENT, COPYRIGHT OR OTHER INTELLECTUAL PROPERTY RIGHT.

### LIFE SUPPORT POLICY

**NATIONAL'S PRODUCTS ARE NOT AUTHORIZED FOR USE AS CRITICAL COMPONENTS IN LIFE SUPPORT DEVICES OR SYSTEMS WITHOUT THE EXPRESS PRIOR WRITTEN APPROVAL OF THE CHIEF EXECUTIVE OFFICER AND GENERAL COUNSEL OF NATIONAL SEMICONDUCTOR CORPORATION.** As used herein:

Life support devices or systems are devices which (a) are intended for surgical implant into the body, or (b) support or sustain life and whose failure to perform when properly used in accordance with instructions for use provided in the labeling can be reasonably expected to result in a significant injury to the user. A critical component is any component in a life support device or system whose failure to perform can be reasonably expected to cause the failure of the life support device or system or to affect its safety or effectiveness.

National Semiconductor and the National Semiconductor logo are registered trademarks of National Semiconductor Corporation. All other brand or product names may be trademarks or registered trademarks of their respective holders.

Copyright© 2007 National Semiconductor Corporation

For the most current product information visit us at [www.national.com](http://www.national.com)



**National Semiconductor  
Americas Customer  
Support Center**  
Email:  
[new.feedback@nsc.com](mailto:new.feedback@nsc.com)  
Tel: 1-800-272-9959

**National Semiconductor Europe  
Customer Support Center**  
Fax: +49 (0) 180-530-85-86  
Email: [europe.support@nsc.com](mailto:europe.support@nsc.com)  
Deutsch Tel: +49 (0) 69 9508 6208  
English Tel: +49 (0) 870 24 0 2171  
Français Tel: +33 (0) 1 41 91 8790

**National Semiconductor Asia  
Pacific Customer Support Center**  
Email: [ap.support@nsc.com](mailto:ap.support@nsc.com)

**National Semiconductor Japan  
Customer Support Center**  
Fax: 81-3-5639-7507  
Email: [jpn.feedback@nsc.com](mailto:jpn.feedback@nsc.com)  
Tel: 81-3-5639-7560