



Micro Commercial Components
 21201 Itasca Street Chatsworth
 CA 91311
 Phone: (818) 701-4933
 Fax: (818) 701-4939

UPS120E THRU UPS140E

Features

- High Power Surface Mount Package
- Guard Ring Protection
- Low Forward Voltage
- Integral Heat Sink/Locking Tabs
- Compatible with Automatic Insertion Equipment

1 Amp Schottky Rectifier 20 to 40 Volts

Maximum Ratings

- Operating Temperature: -55°C to +150°C
- Storage Temperature: -55°C to +150°C
- Maximum Thermal Resistance; 30°C/W Junction To Tab
- Maximum Thermal Resistance; 10°C/W Junction To Bottom

| MCC Catalog Number | Device Marking | Maximum Recurrent Peak Reverse Voltage | Maximum RMS Voltage | Maximum DC Blocking Voltage |
|--------------------|----------------|--|---------------------|-----------------------------|
| UPS120E | UPS120E | 20V | 14V | 20V |
| UPS130E | UPS130E | 30V | 21V | 30V |
| UPS140E | UPS140E | 40V | 28V | 40V |

DO-216AA (POWERMITE™)

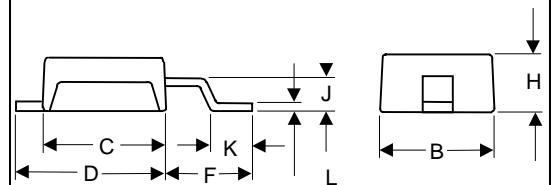
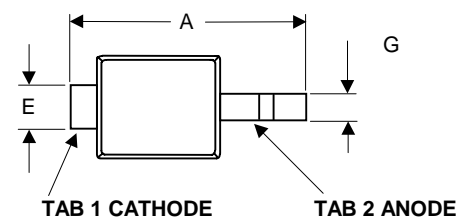

Electrical Characteristics @ 25°C Unless Otherwise Specified

| | | | |
|---|-------------|----------------|---|
| Average Forward Current | $I_{F(AV)}$ | 1.0A | $T_J = 130^\circ\text{C}$ |
| Peak Forward Surge Current | I_{FSM} | 50A | 8.3ms, half sine |
| Maximum Instantaneous Forward Voltage UPS120E UPS130-140E | V_F | .45 V .55 V | $I_{FM} = 1.0\text{A};$ $T_J = 25^\circ\text{C}^*$ |
| Maximum DC Reverse Current At Rated DC Blocking Voltage | I_R | 1.0uA 500uA | $T_J = 25^\circ\text{C}$ $T_J = 125^\circ\text{C}$ |
| Typical Junction Capacitance | C_J | 150pF | Measured at 1.0MHz, $V_R=4.0\text{V}$ |

*Pulse test: Pulse width 200 μsec , Duty cycle 2%

| DIM | DIMENSIONS | | | | NOTE |
|-----|------------|------|------|------|------|
| | INCHES | | MM | | |
| A | .143 | .153 | 3.63 | 3.89 | |
| B | .070 | .080 | 1.78 | 2.03 | |
| C | .070 | .080 | 1.78 | 2.03 | |
| D | .087 | .097 | 2.21 | 2.46 | |
| E | .029 | .039 | 0.74 | 0.99 | |
| F | .051 | .061 | 1.30 | 1.55 | |
| G | ---- | .026 | ---- | 0.66 | |
| H | .035 | .045 | 0.89 | 1.14 | |
| J | .021 | .031 | 0.53 | 0.79 | |
| K | ---- | .025 | ---- | 0.64 | |
| L | ---- | .006 | ---- | 0.15 | |

NOTE: POWERMITE™ package is patental by microsemi corp.

Figure 1
Typical Forward Characteristics

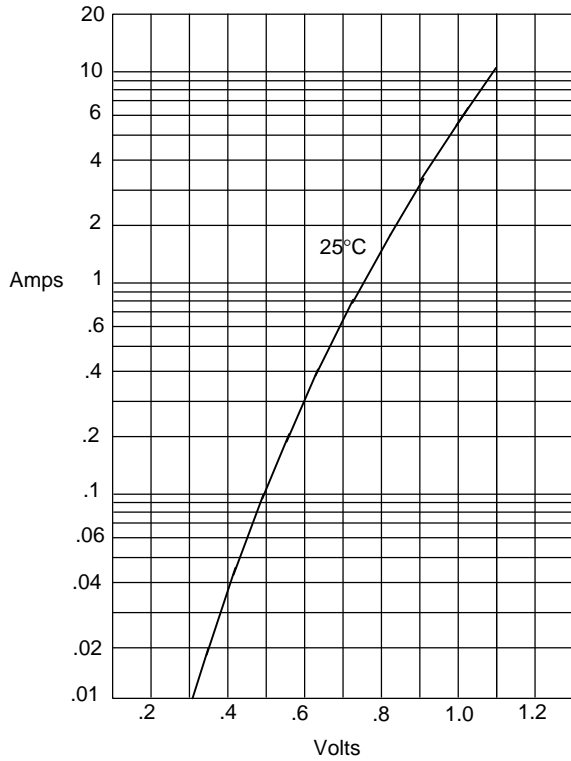

Instantaneous Forward Current - Amperes versus Instantaneous Forward Voltage - Volts

Figure 2
Forward Derating Curve

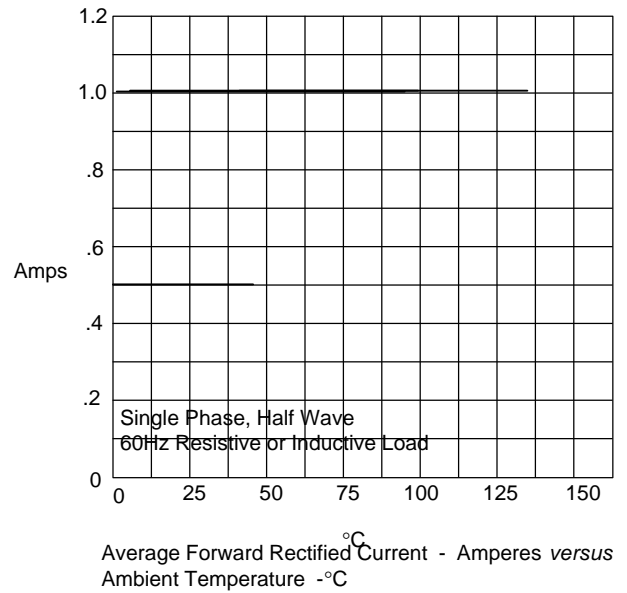

Average Forward Rectified Current - Amperes versus Ambient Temperature - °C

Figure 3
Junction Capacitance

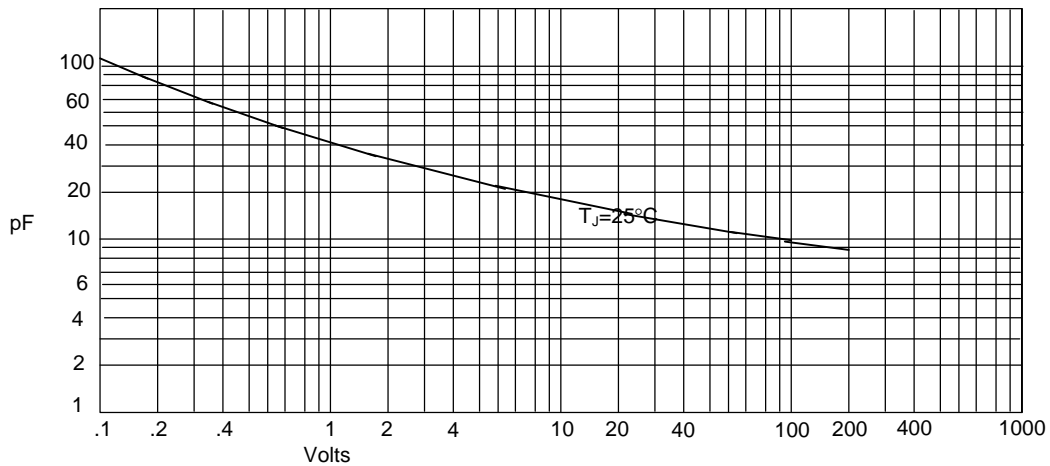

Junction Capacitance - pF versus Reverse Voltage - Volts

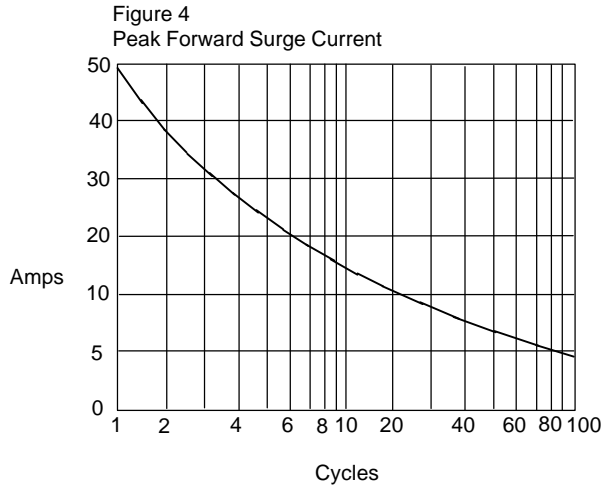

Peak Forward Surge Current - Amperes *versus* Number Of Cycles At 60Hz - Cycles

Figure 6
Reverse Recovery Time Characteristic And Test Circuit Diagram

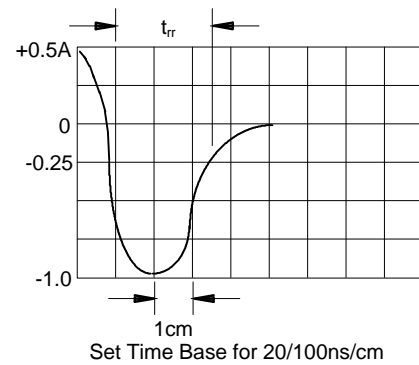
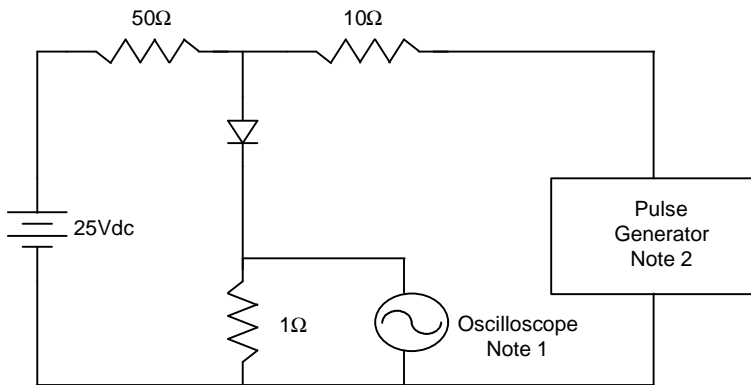

- Notes:
1. Rise Time = 7ns max.
Input impedance = 1 megohm, 22pF
 2. Rise Time = 10ns max.
Source impedance = 50 ohms
 3. Resistors are non-inductive