

International
IR Rectifier

89CNQ...A Series

SCHOTTKY RECTIFIER
 New GenIII D-61 Package

80 Amp

Major Ratings and Characteristics

Characteristics	89CNQ...A	Units
$I_{F(AV)}$ Rectangular waveform	80	A
V_{RRM}	135 to 150	V
I_{FSM} @tp = 5 μ s sine	4300	A
V_F @40 Apk, $T_J = 125^\circ\text{C}$ (perleg)	0.69	V
T_J range	-55 to 175	$^\circ\text{C}$



Description/Features

The 89CNQ...A center tap Schottky rectifier module has been optimized for very low forward voltage drop, with moderate leakage. The proprietary barrier technology allows for reliable operation up to 175 $^\circ\text{C}$ junction temperature. Typical applications are in switching power supplies, converters, free wheeling diodes, and reverse battery protection.

- 175 $^\circ\text{C}$ T_J operation
- Center tap module
- High purity, high temperature epoxy encapsulation for enhanced mechanical strength and moisture resistance
- Low forward voltage drop
- High frequency operation
- Guard ring for enhanced ruggedness and long term reliability

New fully transfer-mold low profile, small footprint, high current package

Case Styles

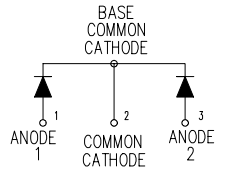
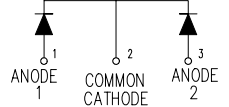
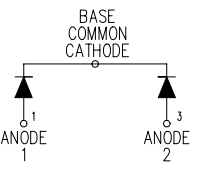
89CNQ...A	89CNQ...ASM	89CNQ...ASL
		
		
D61-8	D61-8-SM	D61-8-SL

89CNQ...A Series

Bulletin PD-20046 rev. C 07/02

International
IR Rectifier

Voltage Ratings

Part number	89CNQ135A	89CNQ150A
V_R Max. DC Reverse Voltage (V)	135	150
V_{RWM} Max. Working Peak Reverse Voltage (V)		

Absolute Maximum Ratings

Parameters	89CNQ	Units	Conditions
$I_{F(AV)}$ Max. Av. Forward Current (Per Leg) See Fig. 5 (Per Device)	40 80	A	50% duty cycle @ $T_C = 130^\circ\text{C}$, rectangular waveform (Rated V_R)
I_{FSM} Max. Peak One Cycle Non-Repetitive Surge Current (Per Leg) See Fig. 7	4300 500	A	5 μs Sine or 3 μs Rect. pulse 10ms Sine or 6ms Rect. pulse Following any rated load condition and with rated V_R applied
E_{AS} Non-Repetitive Avalanche Energy (Per Leg)	9	mJ	$T_J = 25^\circ\text{C}$, $I_{AS} = 1$ Amps, $L = 18$ mH
I_{AR} Repetitive Avalanche Current (Per Leg)	1.0	A	Current decaying linearly to zero in 1 μsec Frequency limited by T_J max. $V_A = 1.5 \times V_R$ typical

Electrical Specifications

Parameters	89CNQ	Units	Conditions
V_{FM} Max. Forward Voltage Drop (Per Leg) See Fig. 1 (1)	0.99	V	@ 40A
	1.14	V	@ 80A
	0.69	V	@ 40A
	0.78	V	@ 80A
I_{RM} Typical Reverse Leakage Current (Per Leg) See Fig. 2 (1)	1.5	mA	$T_J = 25^\circ\text{C}$
	21	mA	$T_J = 125^\circ\text{C}$
C_T Max. Junction Capacitance (Per Leg)	980	pF	$V_R = 5V_{DC}$, (test signal range 100Khz to 1Mhz) 25°C
L_S Typical Series Inductance (Per Leg)	5.5	nH	Measured lead to lead 5mm from package body
dv/dt Max. Voltage Rate of Change (Rated V_R)	10000	V/ μs	

(1) Pulse Width < 300 μs , Duty Cycle <2%

Thermal-Mechanical Specifications

Parameters	89CNQ	Units	Conditions
T_J Max. Junction Temperature Range	-55 to 175	$^\circ\text{C}$	
T_{stg} Max. Storage Temperature Range	-55 to 175	$^\circ\text{C}$	
R_{thJC} Max. Thermal Resistance Junction to Case (Per Leg)	0.85	$^\circ\text{C/W}$	DC operation
R_{thJC} Max. Thermal Resistance Junction to Case (Per Package)	0.42	$^\circ\text{C/W}$	DC operation
R_{thCS} Typical Thermal Resistance, Case to Heatsink (D61-8 Only)	0.30	$^\circ\text{C/W}$	Mounting surface, smooth and greased Device flatness < 5 mils
wt Approximate Weight	7.8 (0.28)	g (oz.)	
T Mounting Torque (D61-8 Only)	Min. 40 (35)	Kg-cm (lbf-in)	
	Max. 58 (50)		

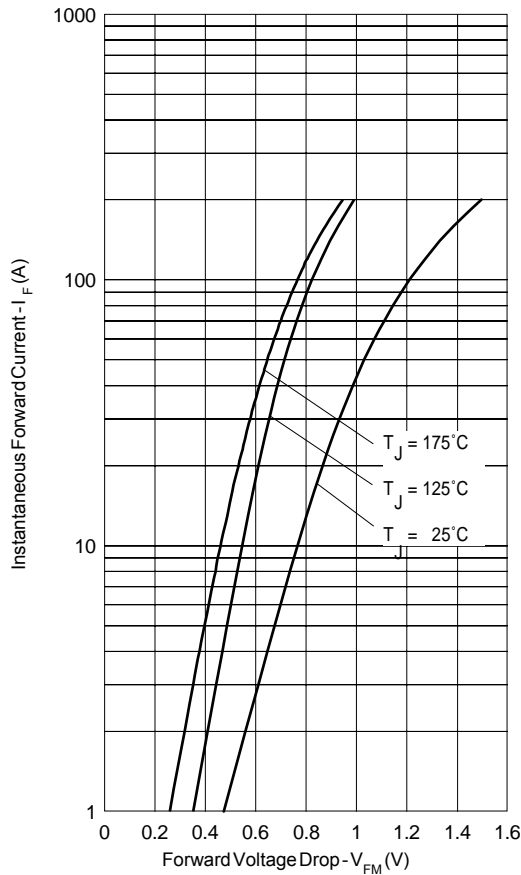

Fig. 1 - Max. Forward Voltage Drop Characteristics (Per Leg)

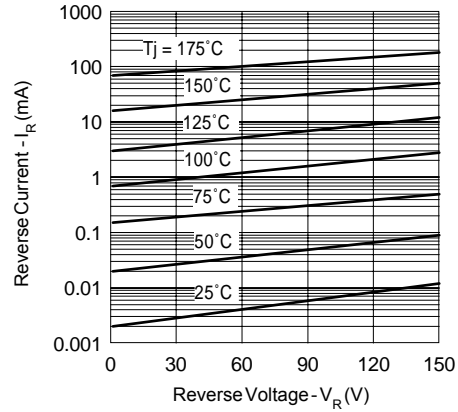

Fig. 2 - Typical Values Of Reverse Current Vs. Reverse Voltage (Per Leg)

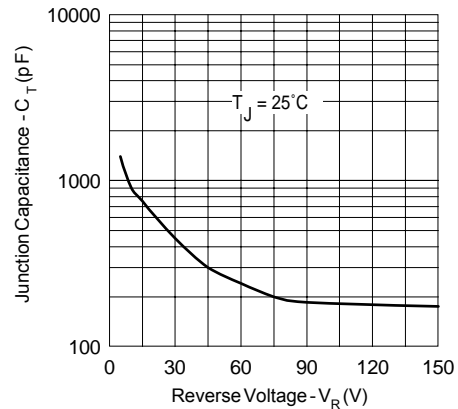

Fig. 3 - Typical Junction Capacitance Vs. Reverse Voltage (Per Leg)

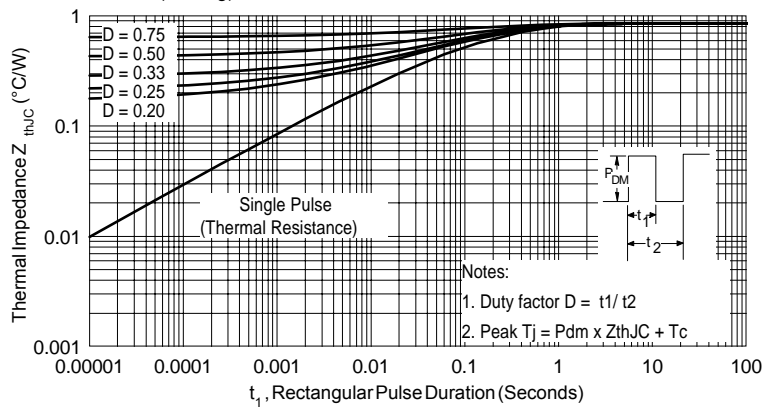

Fig. 4 - Max. Thermal Impedance Z_{thJC} Characteristics (Per Leg)

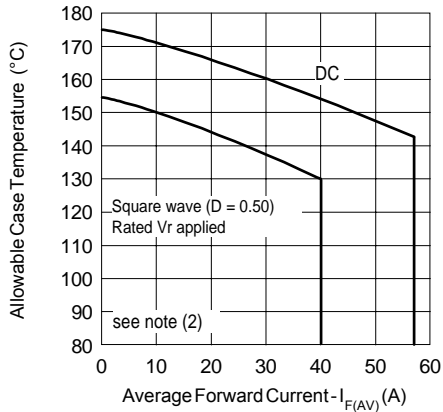

Fig. 5 - Max. Allowable Case Temperature Vs. Average Forward Current (Per Leg)

Average Power Loss (Watts)

Fig. 6 - Forward Power Loss Characteristics (Per Leg)

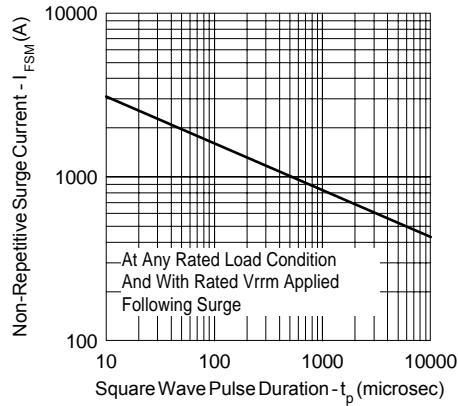

Fig. 7 - Max. Non-Repitative Surge Current (Per Leg)

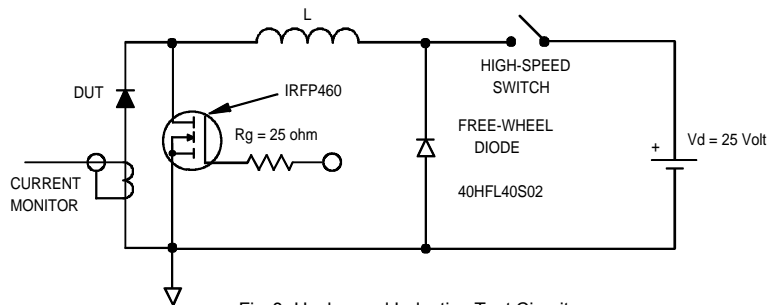
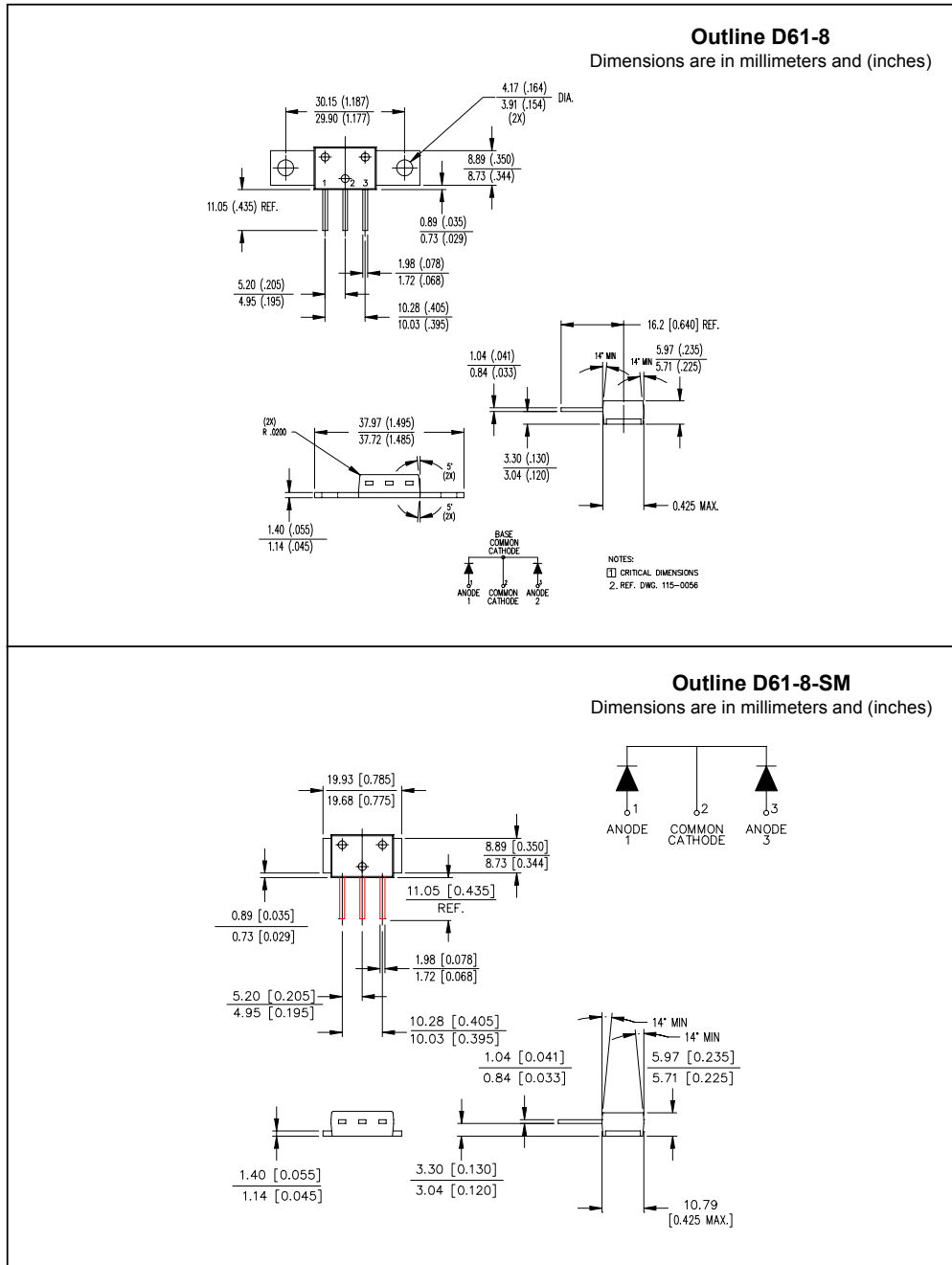

Fig. 8 - Unclamped Inductive Test Circuit

- (2) Formula used: $T_C = T_J - (P_d + P_{d_{REV}}) \times R_{thJC}$
 $P_d = \text{Forward Power Loss} = I_{F(AV)} \times V_{FM} @ (I_{F(AV)}/D)$ (see Fig. 6);
 $P_{d_{REV}} = \text{Inverse Power Loss} = V_{R1} \times I_R (1-D); I_R @ V_{R1} = \text{Rated } V_R$

Outline Table



Outline D61-8-SM
 Dimensions are in millimeters and (inches)

Outline Table

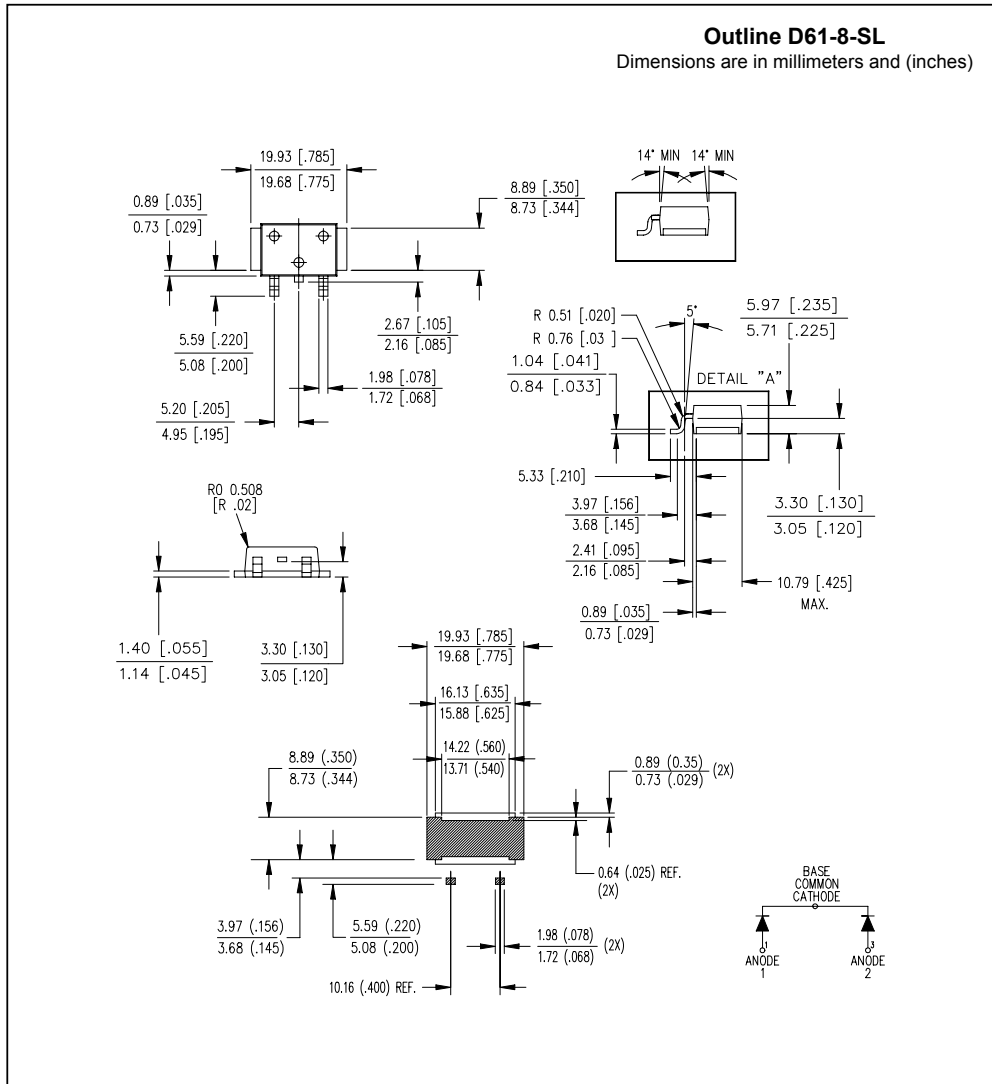

Part Marking Information

EXAMPLE: THIS IS A 89CNQ150A WITH
 LOT CODE 89 09
 ASSEMBLED ON WW 45, 2000
 IN THE ASSEMBLY LINE "A"

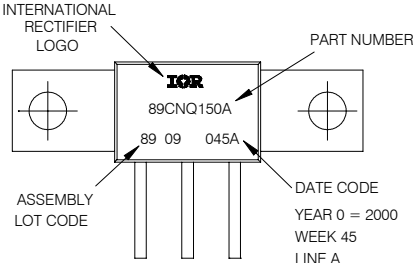

D61-8

EXAMPLE: THIS IS A 89CNQ150ASM WITH
 LOT CODE 89 09
 ASSEMBLED ON WW 45, 2000
 IN THE ASSEMBLY LINE "A"

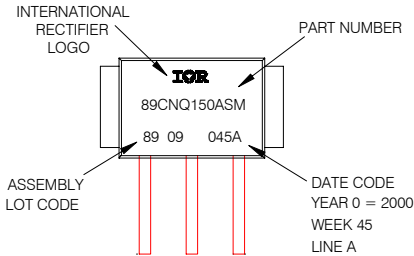

D61-8-SM

EXAMPLE: THIS IS A 89CNQ150ASL WITH
 LOT CODE 89 09
 ASSEMBLED ON WW 45, 2000
 IN THE ASSEMBLY LINE "A"

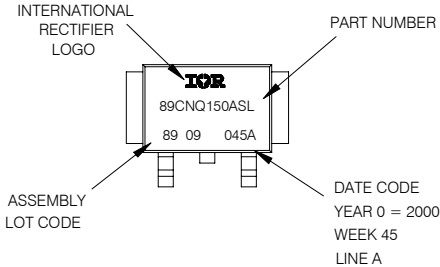

D61-8-SL

Data and specifications subject to change without notice.
This product has been designed and qualified for Industrial Level.
Qualification Standards can be found on IR's Web site.

International
IOR Rectifier

IR WORLD HEADQUARTERS: 233 Kansas St., El Segundo, California 90245, USA Tel: (310) 252-7105
TAC Fax: (310) 252-7309
Visit us at www.irf.com for sales contact information. 07/02