

Typical Applications

- CATV Amplifiers
- Cable Modems
- Broadband Gain Blocks
- Return Channel Amplifier
- Base Stations

Product Description

The RF2318 is a broadband general purpose, low cost high linearity RF amplifier IC. The device is manufactured on an advanced Gallium Arsenide Heterojunction Bipolar Transistor (HBT) process, and has been designed for use as an easily cascadable 75Ω gain block. The gain flatness of better than 1.0dB from 5MHz to 1000MHz, and the high linearity, make this part ideal for cable TV applications. Other applications include IF and RF amplification in wireless voice and data communication products operating in frequency bands up to 5000MHz. The device is self-contained with 75Ω input and output impedances, and requires only two external DC biasing elements to operate as specified.

Optimum Technology Matching® Applied

- Si BJT       GaAs HBT       GaAs MESFET  
 Si Bi-CMOS       SiGe HBT       Si CMOS

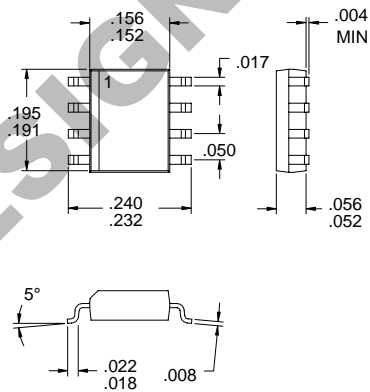

Package Style: SOP-8

Features

- DC to over 5000MHz Operation
- Internally Matched Input and Output
- 8dB Small Signal Gain
- 6dB Noise Figure
- +18dBm Output Power
- Single 9V to 12V Positive Power Supply

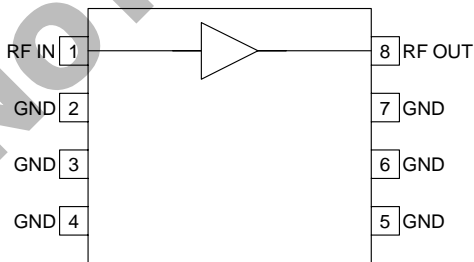

Functional Block Diagram

Ordering Information

- RF2318      Linear Broadband Amplifier  
 RF2318 PCBA-L      Fully Assembled Evaluation Board (DC to 3GHz)  
 RF2318 PCBA-H      Fully Assembled Evaluation Board (3GHz to 6GHz)

RF Micro Devices, Inc.  
7625 Thorndike Road  
Greensboro, NC 27409, USA

Tel (336) 664 1233  
Fax (336) 664 0454  
<http://www.rfmd.com>

## Absolute Maximum Ratings

Parameter	Rating	Unit
Device Current	70	mA
Input RF Power	+13	dBm
Output Load VSWR	20:1	
Ambient Operating Temperature	-40 to +85	°C
Storage Temperature	-40 to +150	°C



Caution! ESD sensitive device.

RF Micro Devices believes the furnished information is correct and accurate at the time of this printing. However, RF Micro Devices reserves the right to make changes to its products without notice. RF Micro Devices does not assume responsibility for the use of the described product(s).

3

LINEAR CATV  
AMPLIFIERS

Parameter	Specification			Unit	Condition
	Min.	Typ.	Max.		
<b>Overall (50Ω)</b>					T=27°C, V <sub>CC</sub> =9V, I <sub>CC</sub> =60mA, R <sub>C</sub> =30Ω
Frequency Range		DC to 5000		MHz	1 dB Bandwidth
Gain	8	8	9	dB	From 10MHz to 1000MHz
	8	9	10	dB	From 1000MHz to 2000MHz
	10	11	12	dB	From 2000MHz to 5000MHz
Noise Figure		6		dB	From 50MHz to 300MHz, -30°C to +70°C
		6		dB	From 300MHz to 1000MHz, -30°C to +70°C
Input VSWR		1.6:1	1.9:1		From 10MHz to 1800MHz
			1.4:1		From 1800MHz to 5000MHz
Output VSWR		2.0:1	3.0:1		Appropriate values for the DC blocking capacitors and bias inductor are required to maintain these VSWRs at the intended operating frequency range.
			1.9:1		From 10MHz to 1800MHz
			3.0:1		From 1800MHz to 4000MHz
					From 4000MHz to 5000MHz
					Appropriate values for the DC blocking capacitors and bias inductor are required to maintain these VSWRs at the intended operating frequency range.
Output IP <sub>2</sub>		+50		dBm	Tones at 500MHz and 900MHz
Output IP <sub>3</sub>	+30			dBm	At 100MHz
	+33	+35		dBm	At 500MHz
	+30	+33		dBm	At 900MHz
Output P <sub>1dB</sub>		TBD		dBm	At 100MHz
		TBD		dBm	At 500MHz
		TBD		dBm	At 900MHz
Saturated Output Power		TBD		dBm	At 100MHz
Saturated Output Power		18		dBm	At 500MHz
Saturated Output Power		TBD		dBm	At 900MHz
Reverse Isolation		15		dB	From 30MHz to 4000MHz
			20	dB	From 4000MHz to 5000MHz
<b>Power Supply</b>					
Device Voltage (V <sub>D</sub> )		7.0		V	On pin 8, I <sub>CC</sub> =63mA
		6.5		V	On pin 8, I <sub>CC</sub> =49mA
Operating Current Range		63	65	mA	V <sub>D</sub> =7.0V

Parameter	Specification			Unit	Condition
	Min.	Typ.	Max.		
<b>Overall (75Ω)</b>					T=25°C, V <sub>CC</sub> =9V, I <sub>cc</sub> =63mA, R <sub>C</sub> =30Ω, 75Ω System
Frequency Range		DC to 5000		MHz	1dB Bandwidth
Gain		8		dB	
Noise Figure		6		dB	From 30MHz to 2000MHz, -30°C to +70°C
Input VSWR		1.3:1			From 30MHz to 2000MHz, -30°C to +70°C
		1.4:1			From 2000MHz to 4000MHz
		1.6:1			From 4000MHz to 5000MHz
Output VSWR		2.0:1	2.6:1		Appropriate values for the DC blocking capacitors and bias inductor are required to maintain these VSWRs at the intended operating frequency range.
					From 30MHz to 1000MHz, -30°C to +70°C
					From 1000MHz to 5000MHz
					Appropriate values for the DC blocking capacitors and bias inductor are required to maintain these VSWRs at the intended operating frequency range.
Output IP <sub>2</sub>		+54		dBm	Tones at 500MHz and 900MHz
Output IP <sub>3</sub>		TBD		dBm	At 100MHz
	+36	+37		dBm	At 500MHz
		TBD		dBm	At 900MHz
Output P <sub>1dB</sub>		TBD		dBm	At 100MHz
		18		dBm	At 500MHz
		18		dBm	At 900MHz
Saturated Output Power		TBD		dBm	At 100MHz
		19		dBm	At 500MHz
		18.5		dBm	At 900MHz
Reverse Isolation		15	20	dB	From 30MHz to 4000MHz
				dB	From 4000MHz to 5000MHz
CSO		TBD		dB	77 Channels, 36dBmV output/channel
		TBD		dB	110 Channels, 36dBmV output/channel
CTB		TBD		dB	77 Channels, 36dBmV output/channel
		TBD		dB	110 Channels, 36dBmV output/channel
Cross Modulation		TBD		dB	77 Channels, 36dBmV output/channel
		TBD		dB	110 Channels, 36dBmV output/channel

Pin	Function	Description	Interface Schematic
1	RF IN	RF input pin. This pin is NOT internally DC blocked. A DC blocking capacitor, suitable for the frequency of operation, should be used in all applications. The device has internal feedback, and not using a DC blocking capacitor will disable the temperature compensation. The bias of the device can be controlled by this pin. Adding an optional 1kΩ resistor to ground on this pin reduces the bias level, which may be compensated for by a higher supply voltage to maintain the appropriate bias level. The net effect of this is an increased output power capability, as well as higher linearity for signals with high crest factors. DC coupling of the input is not allowed, because this will override the internal feedback loop and cause temperature instability.	
2	GND	Ground connection. Keep traces physically short and connect immediately to ground plane for best performance. Each ground pin should have a via to the ground plane.	
3	GND	Same as pin 2.	
4	GND	Same as pin 2.	
5	GND	Same as pin 2.	
6	GND	Same as pin 2.	
7	GND	Same as pin 2.	
8	RF OUT	RF output and bias pin. Because DC is present on this pin, a DC blocking capacitor, suitable for the frequency of operation, should be used in most applications. For biasing, an RF choke in series with a resistor is needed. The value for the resistor $R_C$ is 30Ω (0.5W) for $V_{CC}=9V$ and 82Ω for $V_{CC}=12V$ . The DC voltage on this pin is typically 7V with a current of 63mA. In lower power applications the value of $R_C$ can be increased to lower the current and $V_D$ on this pin.	

## Application Schematic

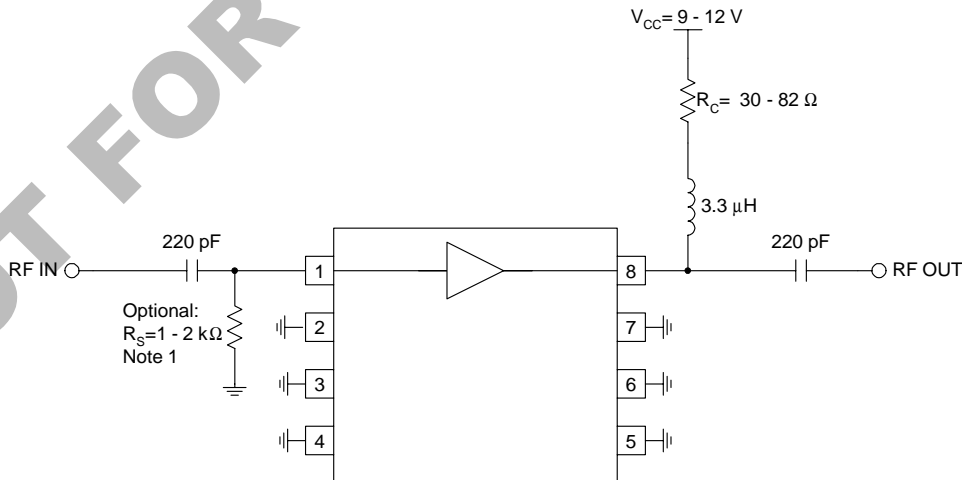

Note 1:  
Optional resistor  $R_s$  can be used to maintain the correct bias level at higher supply voltages. This is useful to increase output capability or linearity for signals with high crest factors.

### Evaluation Board Schematic - DC to 3GHz

(Download [Bill of Materials](http://www.rfmd.com) from www.rfmd.com.)

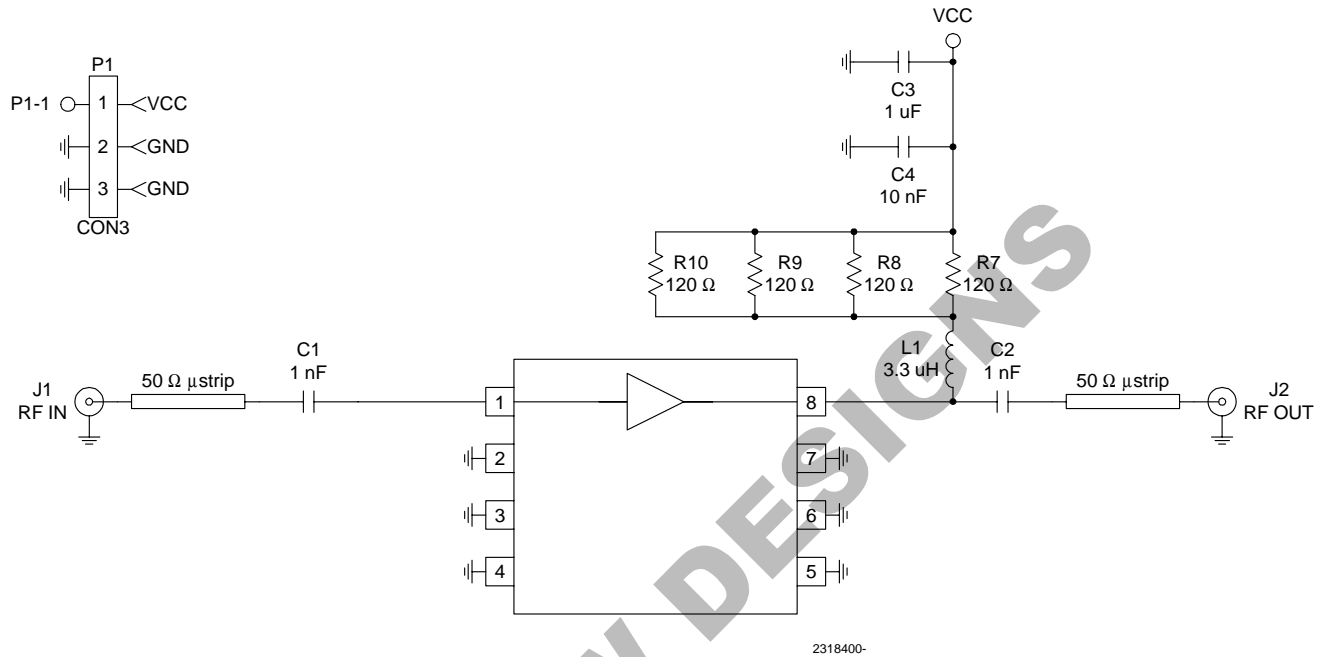

3  
LINEAR CATV  
AMPLIFIERS

### Evaluation Board Schematic - 3GHz to 6GHz

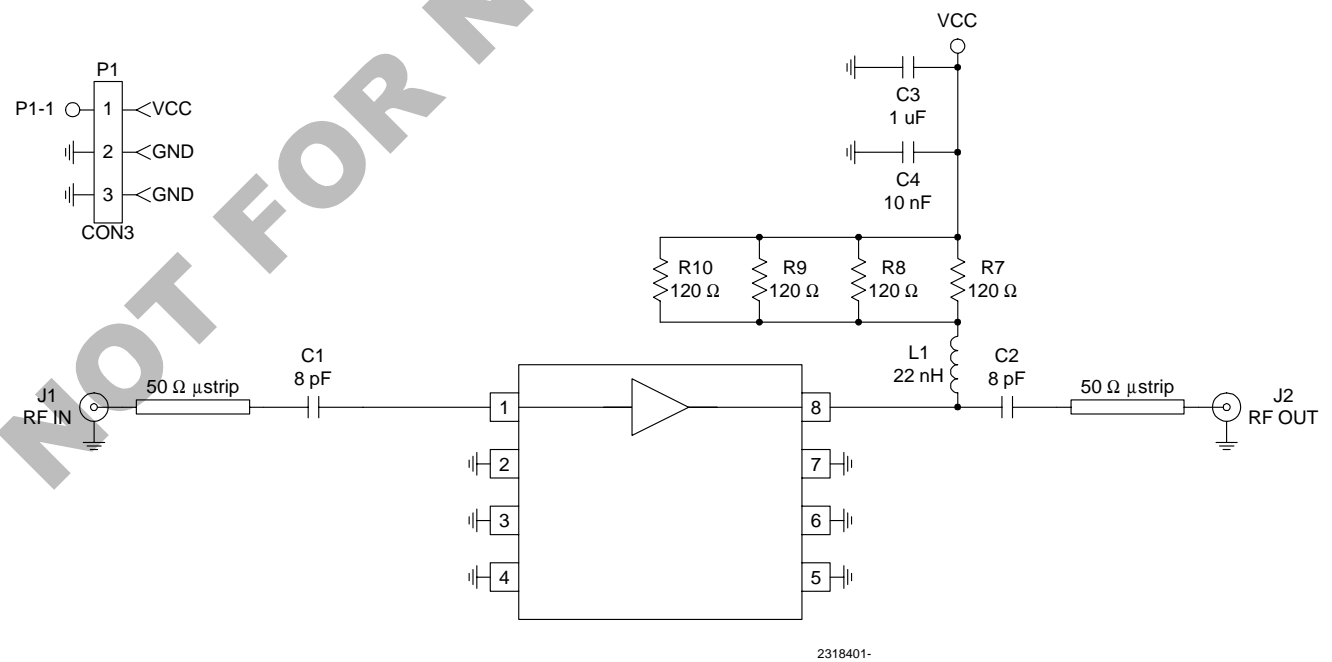

Evaluation Board Layout - DC to 3GHz

Board Size 1.233" x 1.145"

Board Thickness 0.031", Board Material FR-4

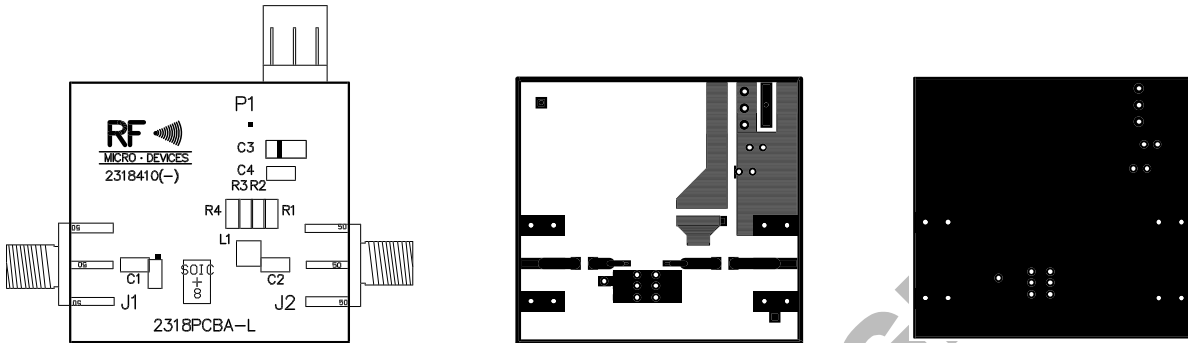

Evaluation Board Layout - 3GHz to 6GHz

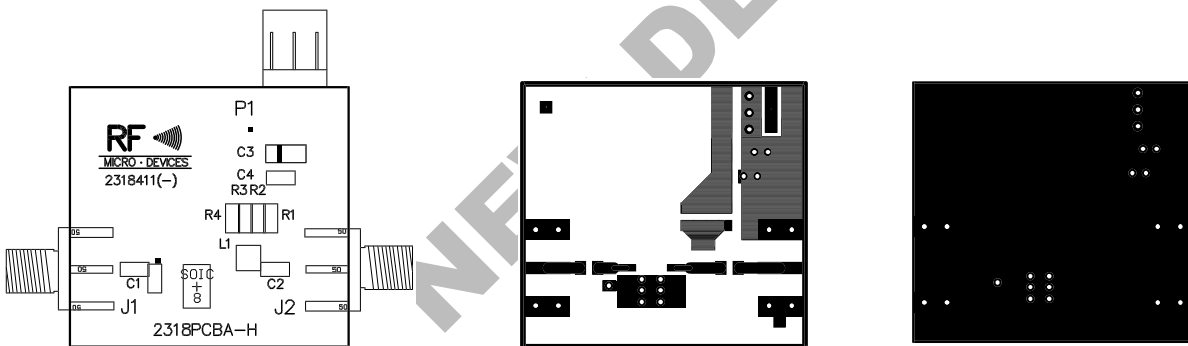

**3**

LINEAR CATV  
AMPLIFIERS

NOT FOR NEW DESIGN