

Specification

UB104S01-2

10.4" (800 x 600) SVGA

Color TFT with Touch

Spec. No.	413-212-101
Version :	1
Total pages :	16
Date :	2001.02.23

**UNIPAC 10.4•COLOR TFT-LCD WITH TOUCH PANEL
MODULE SPECIFICATION**

MODEL NAME: UB104S01-2

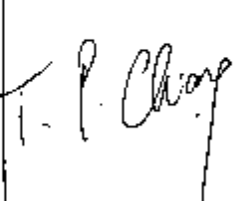
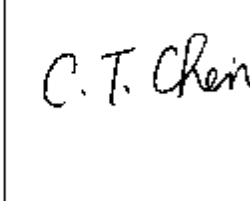
Approved by	Checked by	Prepared by
		

Contents:

A. specifications	Physical P2
B. specifications	Electrical P3
1. assignment	Pin P3
2. Absolute ratings	maximum P4
3. Electrical characteristics	P5
a. Typical operating conditions	P5
b. Display color v. s. input data signals	P6
c. Input signal timing	P7
d. Display position	P8
e. Backlight unit	P8
C. Optical specifications	P10
D. Touch panel specification	P12
E. Reliability test items	P13
F. Display quality	P13
G. Handling precaution	P13
H. Packing form	P14
Appendix:	
Fig.1 LCM outline dimensions	P15
Fig.2 Timing chart	P16

A. Physical specifications

NO.	Item	Specification	Remark
1	Display resolution(pixel)	800(H)×600(V)	
2	Active area(mm)	211.2(H)×158.4(V)	
3	Screen size(inch)	10.4(Diagonal)	
4	Pixel pitch(mm)	0.264(H)×0.264(V)	
5	Color configuration	R. G. B. Vertical stripe	
6	Overall dimension(mm)	236.0(W)×174.3(H)×7.4(D)	Note 1
7	Weight(g)	420 ±10	

Note 1: Refer to Fig. 1.

B. Electrical specifications

1.Pin assignment

(1).Input signal interface

Pin no	Symbol	Function	Etc.
1	V _{CC}	+3.3 V power supply	
2	V _{CC}	+3.3 V power supply	
3	GND	Ground	
4	GND	Ground	
5	RxIN0-	LVDS receiver signal channel 0	
6	RxIN0+		
7	GND	Ground	
8	RxIN1-	LVDS receiver signal channel 1	
9	RxIN1+		
10	GND	Ground	
11	RxIN2-	LVDS receiver signal channel 2	
12	RxIN2+		
13	GND	Ground	
14	CKIN-	LVDS receiver signal clock	
15	CKIN+		
16	GND	Ground	
17	NC	No Connection	
18	NC	No Connection	
19	GND	Ground	
20	GND	Ground	

CN1 (20P) connector: HRS DF 19K-20P-1H or Compatible

(2) LVDS transmitter/receiver signal mapping

	Symbol	Function	
TxIN0	R0	Red data (LSB)	6 bit red display data
TxIN1	R1	Red data	
TxIN2	R2	Red data	
TxIN3	R3	Red data	
TxIN4	R4	Red data	
TxIN5	R5	Red data (MSB)	
TxIN6	G0	Green data (LSB)	6 bit green display data
TxIN7	G1	Green data	
TxIN8	G2	Green data	
TxIN9	G3	Green data	
TxIN10	G4	Green data	
TxIN11	G5	Green data (MSB)	
TxIN12	B0	Blue data (LSB)	6 bits blue display data
TxIN13	B1	Blue data	
TxIN14	B2	Blue data	
TxIN15	B3	Blue data	
TxIN16	B4	Blue data	
TxIN17	B5	Blue data (MSB)	
TxIN18	Hs	Horizontal sync.	
TxIN19	Vs	Vertical sync.	
TxIN20	DE	Data enable	
TxCLKIN	CLK	Clock	Dot clock

2. Absolute maximum ratings

(GND = 0 V)

Parameter	Symbol	Values		Unit	Remark
		Min.	Max.		
Power voltage	V_{CC}	-0.3	4	V_{DC}	At 25•
Input signal voltage	V_{LH}	-0.3	$V_{CC}+0.3$	V_{DC}	At 25•
Operating temperature	T_{op}	0	+60	•	Note 1
Storage temperature	T_{ST}	-20	+70	•	Note 1

Note 1: The relative humidity must not exceed 90% non-condensing at temperatures of 40• or less. At temperatures greater than 40•, the wet bulb temperature must not exceed 39•. When operate at low temperatures, the brightness of CCFL will drop and the lifetime of CCFL will be reduced.

Note 2: The unit should not be exposed to corrosive chemicals.

3. Electrical characteristics

a. Typical operating conditions

	Item	Symbol	Min.	Typ.	Max.	Unit	Remark
Power supply voltage	Input voltage	V_{CC}	3.0	3.3	3.6	V	
	Current consumption	I_A	-	230	-	mArms	Note 1
		I_B	-	260	310	mArms	
	Inrush current	I_{RUSH}	-	-	1500	mApeak	Note 2
Internal logic	Low voltage	V_{IL}	0	-	$0.3 V_{CC}$		
	High voltage	V_{IH}	$0.7 V_{CC}$	-	V_{CC}		
	Power ripple voltage	V_{RP}	-	-	100	mVp-p	

Note 1: Effective value (mArms) at $V_{CC} = 3.3 V/25^\circ$.

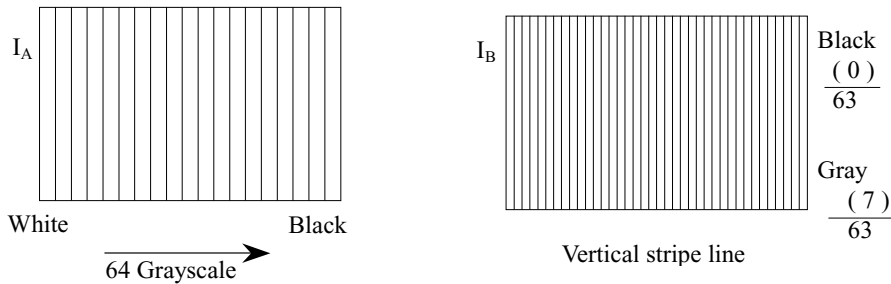

Note 2: Refer to the following power-on condition.

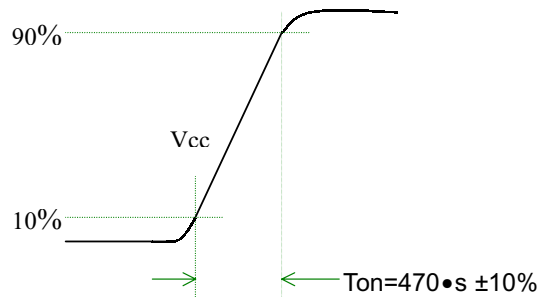

Sequence of Power-on/off and signal-on/off

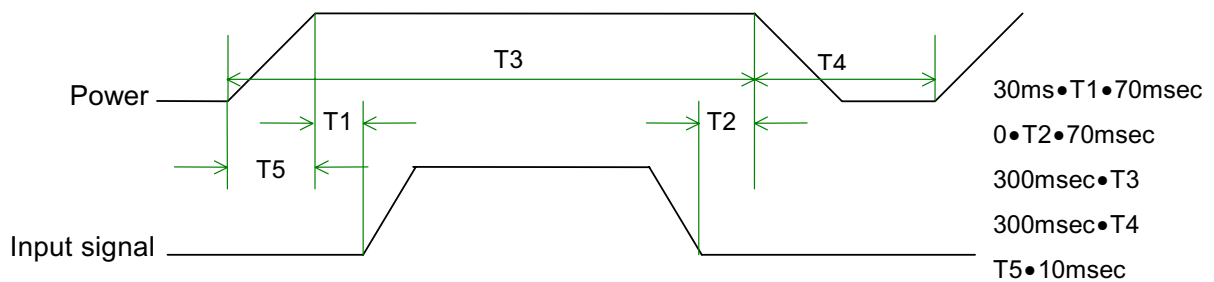

Apply the lamp voltage within the LCD operating range. When the backlight turns on before the LCD operation or the LCD turns off before the backlight turns off, the display may momentarily become abnormal.

Caution

The above on/off sequence should be applied to avoid abnormal function in the display.

In case of handling:

Make sure to turn off the power when you plug the cable into the input connector or pull the cable out of the connector.

b. Display color vs. input data signals

Display colors		Data signal (0 : Low level, 1: High level)																	
		R5	R4	R3	R2	R1	R0	G5	G4	G3	G2	G1	G0	B5	B4	B3	B2	B1	B0
Basic colors	Black	0	0	0	0	0	0	0	0	0	0	0	0	0	0	0	0	0	0
	Blue	0	0	0	0	0	0	0	0	0	0	0	0	1	1	1	1	1	1
	Red	1	1	1	1	1	1	0	0	0	0	0	0	0	0	0	0	0	0
	Magenta	1	1	1	1	1	1	0	0	0	0	0	0	1	1	1	1	1	1
	Green	0	0	0	0	0	0	1	1	1	1	1	1	0	0	0	0	0	0
	Cyan	0	0	0	0	0	0	1	1	1	1	1	1	1	1	1	1	1	1
	Yellow	1	1	1	1	1	1	1	1	1	1	1	1	0	0	0	0	0	0
	White	1	1	1	1	1	1	1	1	1	1	1	1	1	1	1	1	1	1
Red grayscale	Black	0	0	0	0	0	0	0	0	0	0	0	0	0	0	0	0	0	0
		0	0	0	0	0	1	0	0	0	0	0	0	0	0	0	0	0	0
	Dark	0	0	0	0	1	0	0	0	0	0	0	0	0	0	0	0	0	0
	•																		
	•																		
	bright	1	1	1	1	0	1	0	0	0	0	0	0	0	0	0	0	0	0
	1	1	1	1	1	0	0	0	0	0	0	0	0	0	0	0	0	0	
	Red	1	1	1	1	1	1	0	0	0	0	0	0	0	0	0	0	0	
Green grayscale	Black	0	0	0	0	0	0	0	0	0	0	0	0	0	0	0	0	0	0
		0	0	0	0	0	0	0	0	0	0	1	0	0	0	0	0	0	0
	Dark	0	0	0	0	0	0	0	0	0	1	0	0	0	0	0	0	0	0
	•																		
	•																		
	bright	0	0	0	0	0	0	1	1	1	1	0	1	0	0	0	0	0	0
	0	0	0	0	0	0	1	1	1	1	1	0	0	0	0	0	0	0	
	Green	0	0	0	0	0	1	1	1	1	1	1	0	0	0	0	0	0	
Blue grayscale	Black	0	0	0	0	0	0	0	0	0	0	0	0	0	0	0	0	0	0
		0	0	0	0	0	0	0	0	0	0	0	0	0	0	0	0	0	1
	Dark	0	0	0	0	0	0	0	0	0	0	0	0	0	0	0	0	1	0
	•																		
	•																		
	bright	0	0	0	0	0	0	0	0	0	0	0	0	1	1	1	1	0	1
	0	0	0	0	0	0	0	0	0	0	0	0	1	1	1	1	1	0	
	Blue	0	0	0	0	0	0	0	0	0	0	0	1	1	1	1	1	1	

Note: Each basic color can be displayed in 64 gray scales using the 6 bit data signals. By

combining the 18-bit data signals(R, G, B), the 262, 144 colors can be achieved on the display.

c. Input signal timing

Timing diagrams of input signal are shown in Fig 2.

(1). Timing characteristics of input signals

(a) DE mode

Item	Symbol	Min.	Typ.	Max.	Unit	Remark
Clock frequency	Fck	38	40	48	MHz	
Horizontal blanking	Thb1	50	256	500	Clk	
Vertical blanking	Tvb1	10	28	150	Th	

(b) HV mode

Item	Symbol	Min.	Typ.	Max.	Unit	Remark
Clock frequency	Fck	38	40	48	MHz	
Hsync period	Th	850	1056	1300	Clk	
Hsync pulse width	Thw	10	128	-	Clk	
Hsync front porch	Thf	15	40	-	Clk	
Hsync back porch	Thb	10	88	-	Clk	
Hsync blanking	Thb1	50	256	500	Clk	
Vsync period	Tv	610	628	750	Th	
Vsync pulse width	Tvw	1	4	-	Th	
Vsync front porch	Tvf	0	1	-	Th	
Vsync blanking	Tvb1	10	28	150	Th	
Hsync/Vsync phase shift	Tvpd	2	320	-	Clk	

Item	Symbol	Value	Unit	Description
Horizontal display start	The	218	Clk	After falling edge of Hsync, counting 218clk, then getting valid data from 219th
Vertical display start	Tve	25	Th	After falling edge of Vsync, counting 25th, then getting 26th Th's data.

(2). The timing condition of LVDS

Item	Symbol	Min.	Typ.	Max.	Unit
The differential level	•VID•	0.1	-	0.6	V
The common mode input voltage	VIC	$\frac{\bullet\text{VID}\bullet}{2}$	-	$2.4 \bullet \frac{\bullet\text{VID}\bullet}{2}$	V
The input setup time	tsu1	0.5	-	-	ns
The input hold time	th1	0.5	-	-	ns

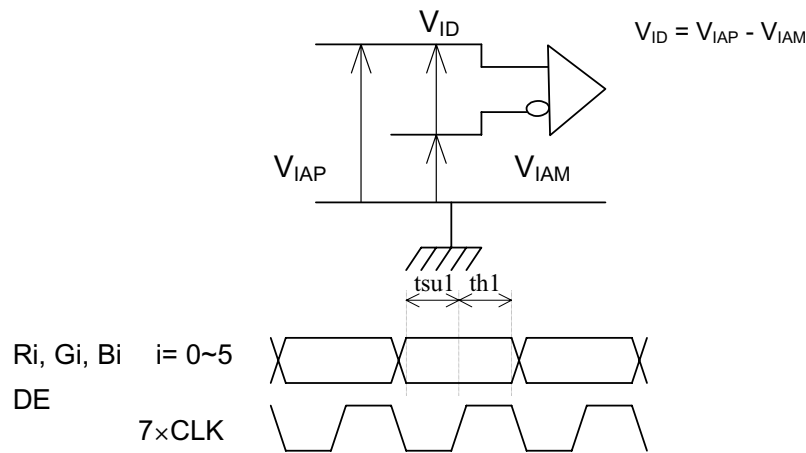

d. Display position

D(1,1)	D(2,1)	D(X,1)	D(799,1)	D(800,1)
D(1,2)	D(2,2)	D(X,2)	D(799,2)	D(800,2)
⋮		⋮	⋮	⋮
D(1,Y)	D(2,Y)	D(X,Y)	D(799,Y)	D(800,Y)
⋮		⋮	⋮	⋮
D(1,599)	D(2,599)	D(X,599)	D(799,599)	D(800,599)
D(1,600)	D(2,600)	D(X,600)	D(799,600)	D(800,600)

e. Backlight unit

The backlight system is an edge-lighting type with a CCFT(Cold Cathode Fluorescent Tube).

The characteristics of a single lamp are shown in the following tables.

Parameter	Symbol	Min.	Typ.	Max.	Unit	Remark
Lamp voltage	V_L	-	560	-	Vrms	Note 1
Lamp current	I_L	-	4.5	-	mArms	Note 1
Power consumption	P_L	-	2.52	-	W	Note 2
Lamp starting voltage	V_s	-	-	1050(T=0•)	Vrms	Note 3
		-	-	800(T=25•)		
Frequency	F_L	-	60	-	KHz	Note 4

Lamp life time	L_L	10000	20000	-	Hr	Note 1, 5
----------------	-------	-------	-------	---	----	-----------

Note 1: $T = 25 \bullet I_L = 4.5\text{mA}$

Note 2: Inverter should be designed with the characteristic of lamp. When you are designing the inverter, the output voltage of the inverter should comply with the following conditions.

- (1). The area under the positive and negative cycles of the waveform of the lamp current and lamp voltage should be area symmetric (the symmetric ratio should be larger than 90%).
- (2). There should not be any spikes in the waveform.
- (3). The waveform should be sine wave as possible.
- (4). Lamp current should not exceed the maximum value within the operating temperature (It is prohibited to over the maximum lamp current even if operated in the non-guaranteed temperature). When lamp current over the maximum value for a long time, it may cause fire. Therefore, it is recommend that the inverter should have the current limit circuit.

Note 3: The inverter open voltage should be designed larger than the lamp starting voltage otherwise backlight may be blinking for a moment after turning on or not be able to turn on. The open voltage should be measured after ballast capacitor. If an inverter has shutdown function it should keep its open voltage for longer than 1 second even if lamp connector is open.

Note 4: Lamp frequency may produce interference with horizontal synchronous frequency and this may cause line flow on the display. Therefore lamp frequency shall be detached from the horizontal synchronous frequency and its harmonics as far as possible in order to avoid interference.

Note 5: Brightness ($I_L = 4.5\text{mA}$) to be decrease to the 50% of the initial value.

Note 6: CN2 connector (backlight): BHSR-02VS-1(JST)

Mating connector: SM02B-BHSS-1-TB (JST)

Pin no.	Symbol	Function	Remark
1	H	CCFL power supply(H.V.)	Cable color: Pink
2	L	CCFL power supply(GND)	Cable color: White

C. Optical specifications – including touch panel(Note 1, Note 2, Note 3)

Item	Symbol	Condition	Specification			Unit	Remark
			Min.	Typ.	Max.		
Response time Rising time Falling time	Tr Tf	●=0°	- -	20 30	40 50	ms	Note 4
Contrast ratio	CR	●=0°	150	250	-		Note 3,5
Viewing angle Top Bottom Left Right		CR●10	10 30 40 40	15 35 45 45	- - - -	deg.	Note 3,6
Brightness	Y_L	●=0°	95	120	-	nit	Note 3,7,8,9
Color chromaticity(CIE)	W_x	●=0°	-	0.316	-		
	W_y		-	0.340	-		
	R_x		-	0.580	-		
	R_y		-	0.315	-		
	G_x		-	0.30	-		
	G_y		-	0.57	-		
	B_x		-	0.145	-		
	B_y		-	0.133	-		
White uniformity	● _w		-	-	1.8		Note 3,10

Note 1: Ambient temperature = 25●.

Note 2: To be measured in dark room after backlight warm up 30 minutes.

Note 3: To be measured with a viewing cone of 1°by Topcon luminance meter BM-5A.

Note 4: Definition of response time:

The output signals of BM-7 are measured when the input signals are changed from “Black” to “White” (falling time) and from “White” to “Black” (rising time), respectively. The response time means the interval between the 10% and 90% of amplitudes. Refer to figure as below.

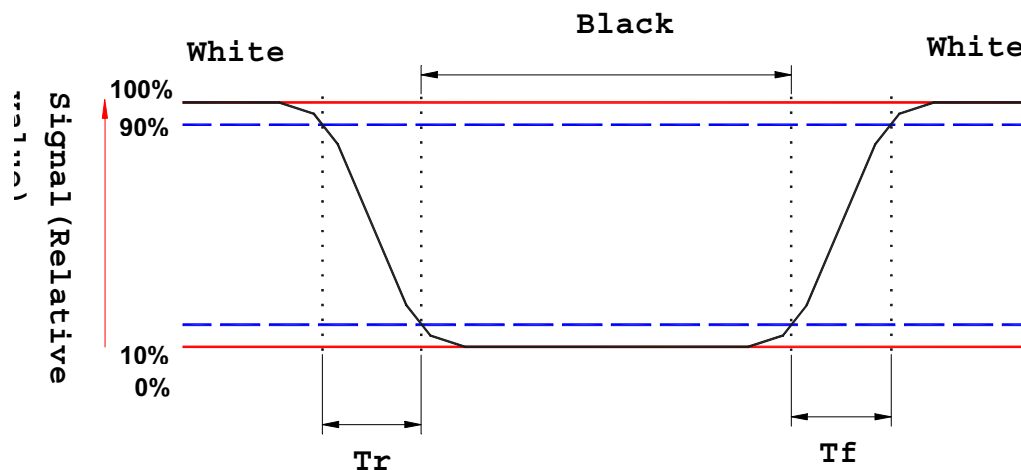

Note 5. Definition of contrast ratio:

Contrast ratio is calculated with the following formula.

$$\text{Contrast ratio (CR)} = \frac{\text{Luminance on the white raster}}{\text{Luminance on the black raster}}$$

Note 6: Definition of brightness: This shall be measured at center of the screen.

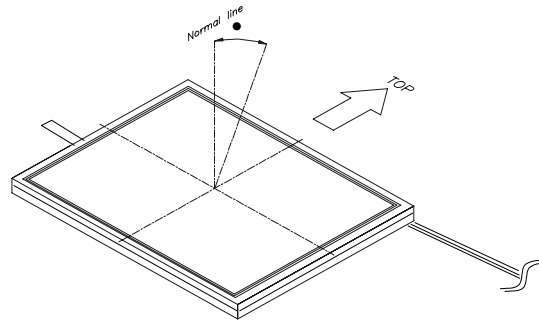

Note 7: Definition of the 13 points (from A to M) on panel, refer to figure as below

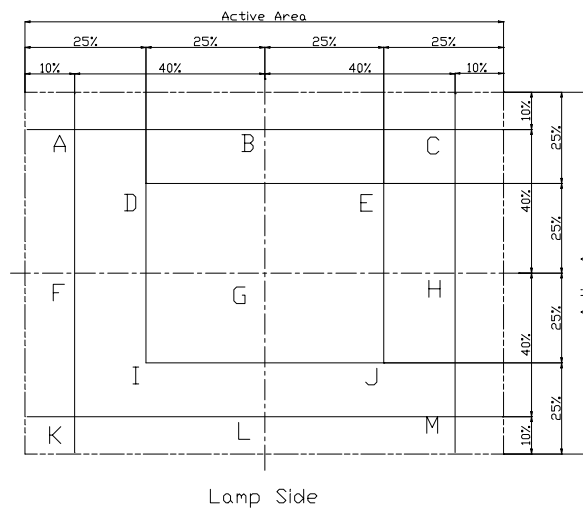

Note 8: Definition of brightness: To average the luminance of center 5 points(D, E,G, I,J)

Note 9: Driving conditions for CCFL : $I_L=4.5$ mA,60KHz Frequency

Note 10: Definition of white uniformity:

$$w = \frac{\text{Maximum Luminance of thirteen points}}{\text{Minimum Luminance of thirteen points}}$$

D. Touch Panel Specification

1. Operating condition

Item	Min.	Typ.	Max.	Unit	Remark
Operating voltage	-	5	-	V _{DC}	

2. Electrical characteristic

Item		Min.	Typ.	Max.	Unit	Remark
Resistance between terminal	XH-XL	150	500	1300	•	
	YH-YL	150	500	1300	•	
Insulation resistance	X-Y	10	-	-	M•	
Linearity	X	-	-	1.5	%	
	Y	-	-	1.5	%	

3. Mechanical characteristic

Item	Min.	Typ.	Max.	Unit	Remark
Pen/Finger input pressure	-	-	120	g	
Surface hardness	-	3	-	H	

CN3: FFC tail

Pin. No.	Symbol	Description
1	XH	High voltage terminal along X-axis
2	YH	High voltage terminal along Y-axis
3	XL	Low voltage terminal along X-axis
4	YL	Low voltage terminal along Y-axis

4. Optical characteristic

Refer to the C. Optical specifications in page 9/15.

E. Reliability test items (Note 1)

Test tem	Test Condition	Remark
High temperature storage	70●, 240Hrs	Note 1, 2, 3
Low temperature storage	-20●, 240Hrs	Note 1, 2, 3
High temperature & high humidity operation	40●, 90%RH, 240Hrs (No condensation)	Note 1, 2, 3
High temperature operation	60●, 240Hrs	Note 1, 2, 3
Low temperature operation	0●, 240Hrs	Note 1, 2, 3
Temperature cycling (non-operation)	-20●~70● 1H, 10mins, 1H, 5cycles	Note 1, 2, 3
Electrostatic discharge (non-operation)	150 pF, 150●, 10kV, 1 second, 9 position on the panel, 10 times each place	Note 3
Vibration (non-operation)	Sweep: 1G, 10Hz ~ 500Hz ~ 10Hz /2.5min 2 hours for each direction X, Y, Z	Note 1, 2, 3
Mechanical shock (non-operation)	50G/11ms, 200G/2ms, ±X, ±Y, ±Z once for each direction	Note 1, 2, 3

Note 1: Evaluation should be tested after storage at room temperature for one hour.

Note 2: There should be no change which might affect the practical display function when the display quality test is conducted under normal operating condition.

Note 3: Judgement : 1. Function OK.

2. No serious image quality degradation.

F. Display quality

The display quality of the color TFT-LCD module should be in compliance with the Unipac's OQC inspection standard.

G. Handling precaution

The Handling of the TFT-LCD should be in compliance with the Unipac's handling principle standard.

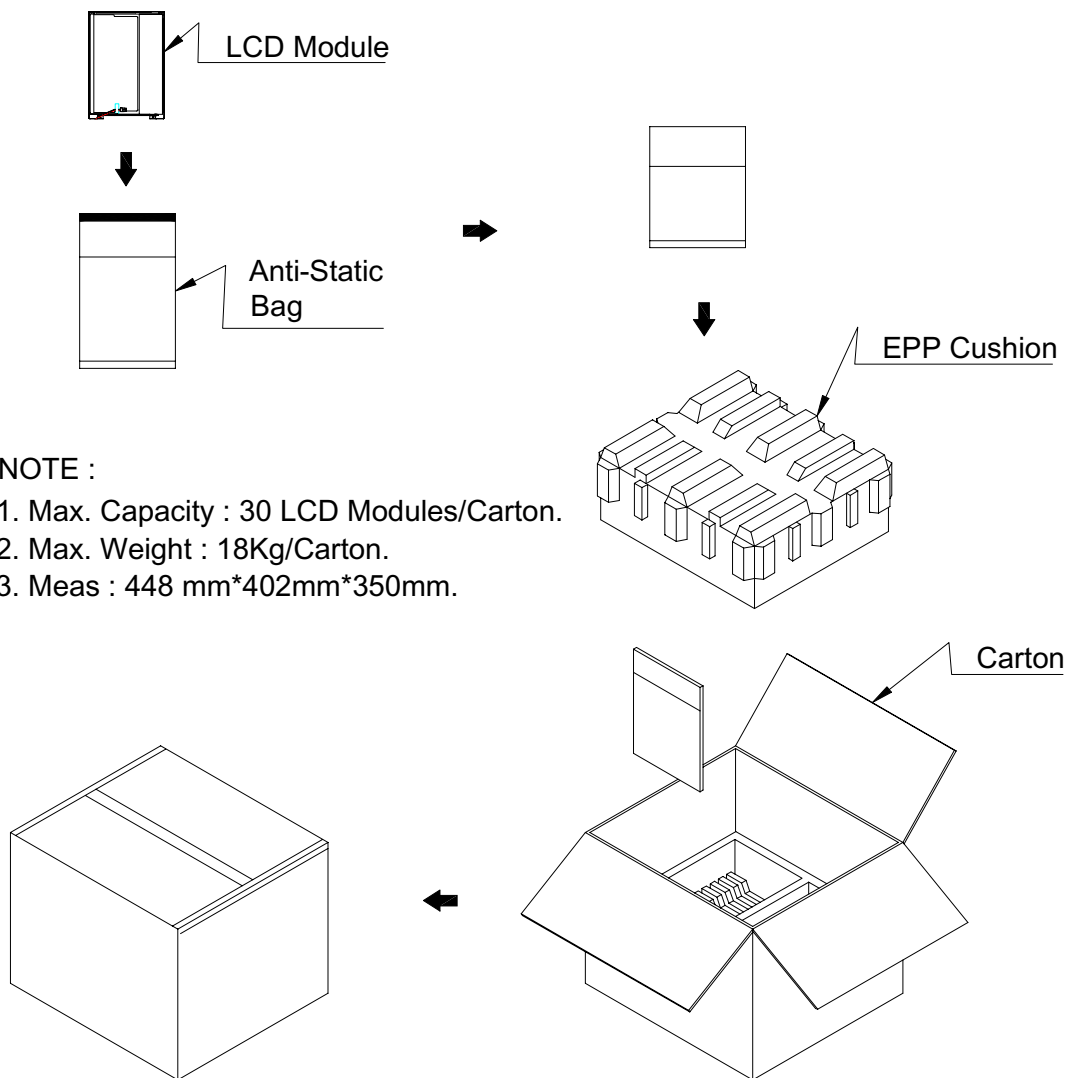
H. Packing form :

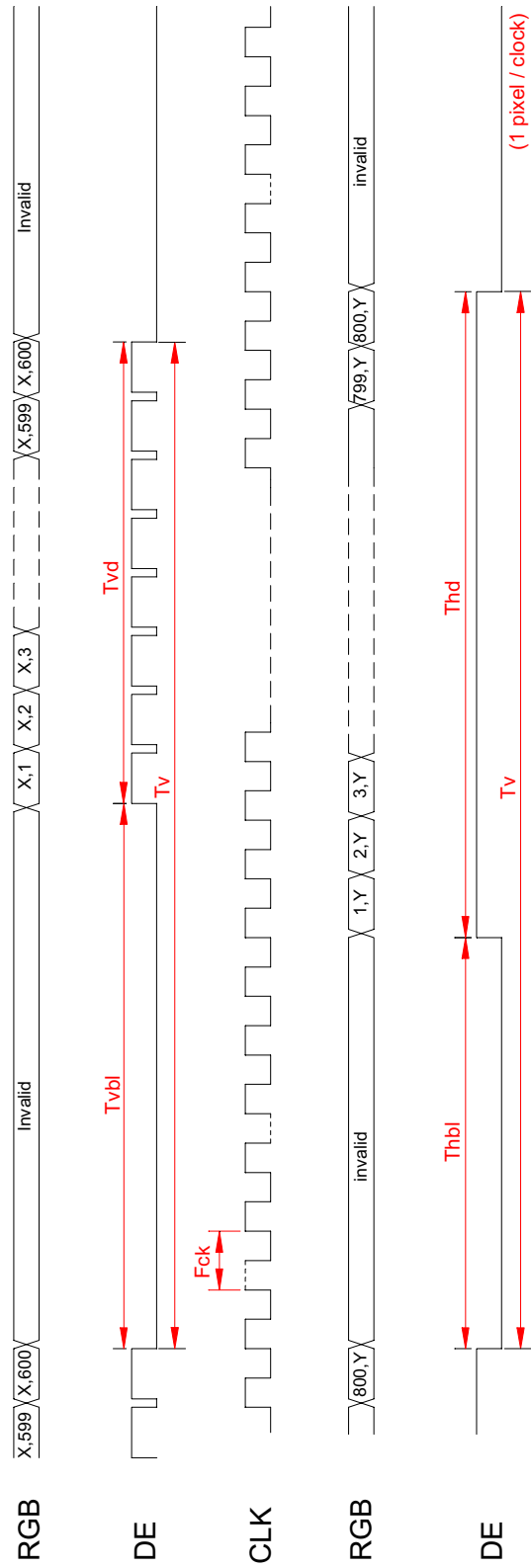

Fig.2 Timing chart