

Diameters 4 - 5 mm •  
 Amplified in d.c. 3 wires •  
 Cable output •

## Housing A-3

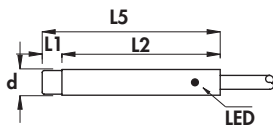

## Housing B-6

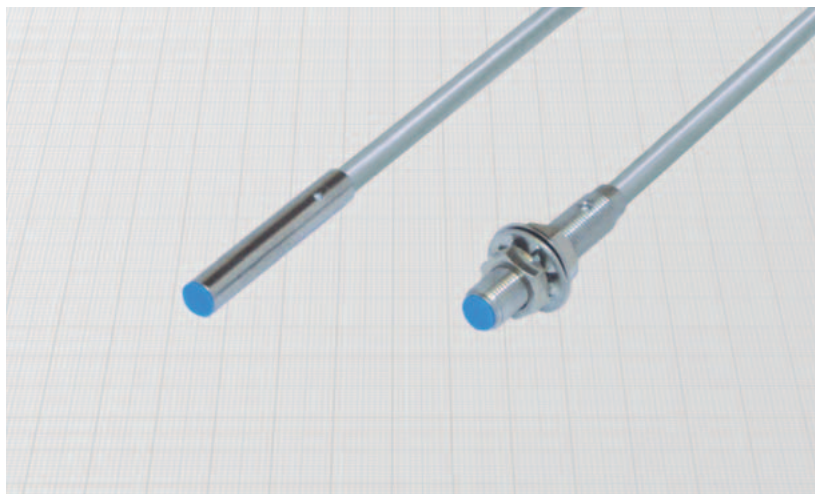
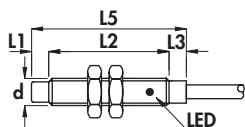

Diameter	M5 x 0,5	
Nut	Size	SW7
	Thickness mm	2,5
Max tightening torque Nm	2	

### Materials:

- Cable: 2 m PVC CEI 20 - 22 II; 90°C; 300 V; O.R.
- Housing: stainless steel
- Sensing face: plastic

### Technical data:

- Supply voltage ( $U_B$ ): 7 ÷ 30 Vdc
- Max ripple: 10%
- No-load supply current ( $I_0$ ): ≤ 10 mA
- Voltage drop ( $U_d$ ): ≤ 1,5 V
- Temperature range: -25° ÷ +70°C
- Max thermal drift of sensing distance  $S_r$ : ± 10%
- Repeat accuracy (R): 2%
- Switching hysteresis (H): 10%
- Degree of protection: IP67
- Switch status indicator: yellow LED
- Cable conductor cross section: 0,15 mm<sup>2</sup>
- Protected against short-circuit and overload (versions with letter K)
- Protected against any wrong connection
- Suppression of initial false impulse
- Electromagnetic compatibility (EMC) according to EN60947-5-2
- Shock and vibration resistance according to EN60068-2-27 EN60068-2-6

www.bdcelectronic.com

Housing	Flush mounting Non flush mounting	L1	L2	L3	L5	Cable diameter	Body diameter (d)	Max switching frequency (f)	Rated operational current ( $I_e$ )	Nominal sensing distance ( $S_n$ ) ± 10%	ORDERING REFERENCES		
											PNP (positive switching)		
A - 3	•	-	25	-	25	3	4	5	200	0,8			
A - 3	•	3	22	-	25	3	4	5	200	1,4			
A - 3	•	-	30	-	30	3	4	5	200	1			
A - 3	•	3	27	-	30	3	4	5	200	1,4			
B - 6	•	-	20	5	25	3	M5 x 0,5	5	200	0,8			
B - 6	•	3	17	5	25	3	M5 x 0,5	5	200	1,4			
B - 6	•	-	25	5	30	3	M5 x 0,5	5	200	1			
B - 6	•	3	22	5	30	3	M5 x 0,5	5	200	1,4			
												NPN (negative switching)	
												Use the above mentioned part number changing the last number 9 with 8 (ie. DCA4/4608LS)	

# CYLINDRICAL INDUCTIVE SENSORS IN METAL HOUSING

- Diameters 6,5 - 8 mm
- Amplified in d.c. 3 and 4 wires
- Cable output

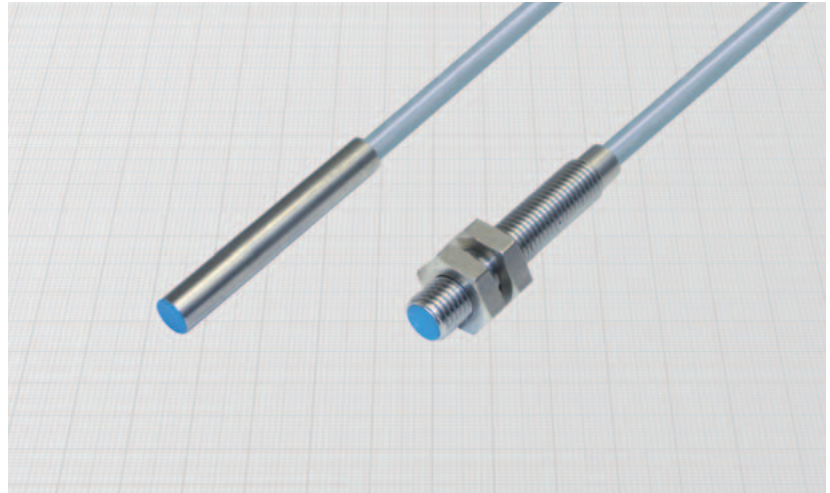
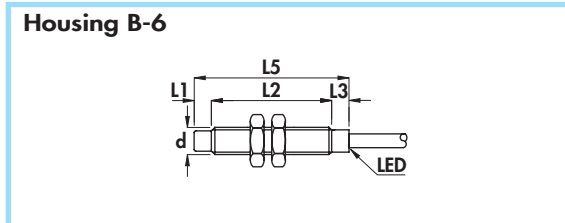
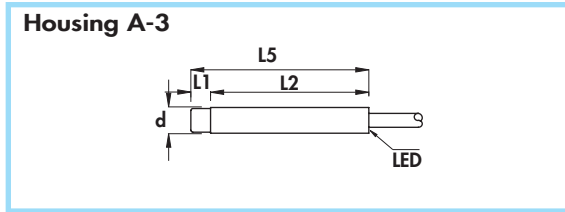

Diameter	M8 x 1	
Nut	Size	SW13
	Thickness mm	4
Max tightening torque Nm	10	

**Materials:**

- Cable: 2 m PVC CEI 20 - 22 II; 90°C; 300 V; O.R.
- Housing: stainless steel
- Sensing face: plastic

**Technical data:**

- Supply voltage ( $U_B$ ): 7 ÷ 30 Vdc
- Max ripple: 10%
- No-load supply current ( $I_0$ ): ≤ 10 mA
- Voltage drop ( $U_d$ ): ≤ 1,5 V
- Temperature range: - 25° ÷ + 70°C
- Max thermal drift of sensing distance  $S_s$ : ± 10%
- Repeat accuracy (R): 2%
- Switching hysteresis (H): 10%
- Degree of protection: IP67
- Switch status indicator: yellow LED
- Cable conductor cross section: 0,15 mm<sup>2</sup> on 4 wires versions  
0,22 mm<sup>2</sup> on 3 wires versions

- Protected against short-circuit and overload
- Protected against any wrong connection
- Suppression of initial false impulse
- Electromagnetic compatibility (EMC) according to EN60947-5-2
- Shock and vibration resistance according to EN60068-2-27 EN60068-2-6

Housing	Flush mounting Non flush mounting	L1	L2	L3	L5	Cable diameter	Body diameter (d)	Max switching frequency (f)	No-load supply current ( $I_0$ )	Nominal sensing distance ( $S_n$ ) ±10%	ORDERING REFERENCES		
											PNP (positive switching)		
A - 3	•	-	45	-	45	3,5	6,5	4	200	1,5			
A - 3	•	5	40	-	45	3,5	6,5	3	200	2,5	<b>DCA6,5/4609LKS</b> <b>DCA6,5/5609LKS</b>	<b>DCA6,5/4619LKS</b> <b>DCA6,5/5619LKS</b>	<b>DCA6,5/4629LKS</b> <b>DCA6,5/5629LKS</b>
A - 3	•	-	45	-	45	3,5	8	4	200	1,5	<b>DCA8/4609LKS</b>	<b>DCA8/4619LKS</b>	<b>DCA8/4629LKS</b>
B - 6	•	-	40	5	45	3,5	M8 x 1	4	200	1,5	<b>DCA8/4609KS</b>	<b>DCA8/4619KS</b>	<b>DCA8/4629KS</b>
A - 3	•	5	40	-	45	3,5	8	3	200	2,5	<b>DCA8/5609LKS</b>	<b>DCA8/5619LKS</b>	<b>DCA8/5629LKS</b>
B - 6	•	5	35	5	45	3,5	M8 x 1	3	200	2,5	<b>DCA8/5609KS</b>	<b>DCA8/5619KS</b>	<b>DCA8/5629KS</b>

**NPN (negative switching)**

Use the above mentioned part number changing the last number 9 with 8 (ie. DCA6,5/4608LKS)

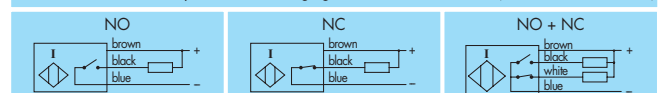

**Diameters 12 mm •**  
**Amplified in d.c. 3 and 4 wires •**  
**Cable output •**

## Housing B-3

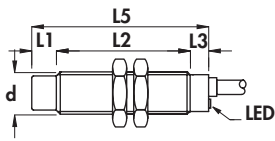

## Housing D

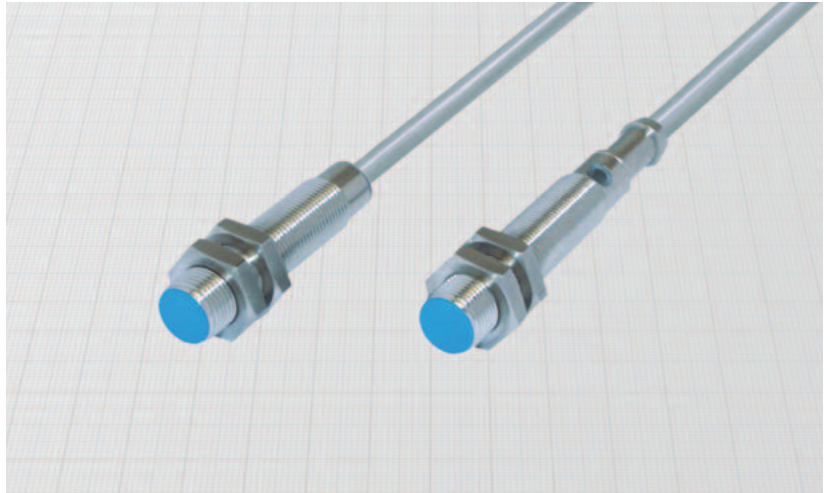
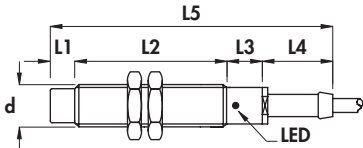

Diameter		M12 x 1	M14 x 1	M16 x 1
Nut	Size	SW17	SW17	SW22
	Thickness mm	4	4	4
Max tightening torque Nm		15	20	25

### Materials:

- Cable: 2 m PVC CEI 20 - 22 II; 90°C; 300 V; O.R.
- Housing: nickel plated brass
- Sensing face: plastic

### Technical data:

- Supply voltage ( $U_B$ ): 5 ÷ 40 Vdc
- Max ripple: 10%
- No-load supply current ( $I_0$ ): ≤ 10 mA
- Voltage drop ( $U_d$ ): ≤ 1,5 V
- Temperature range: -25° ÷ +75°C
- Max thermal drift of sensing distance  $S_r$ : ± 10%
- Repeat accuracy (R): 2%
- Switching hysteresis (H): 10%
- Degree of protection: IP67
- Switch status indicator: yellow LED
- Cable conductor cross section: 0,35 mm<sup>2</sup> on 3 wires  
0,25 mm<sup>2</sup> on 4 wires

- Protected against short-circuit and overload
- Protected against any wrong connection
- Suppression of initial false impulse
- Electromagnetic compatibility (EMC) according to EN60947-5-2
- Shock and vibration resistance according to EN60068-2-27 EN60068-2-6

Housing	Flush mounting Non flush mounting	L1	L2	L3	L4	L5	Cable diameter	Body diameter (d)	Max switching frequency (f)	Rated operational current (I <sub>e</sub> )	Nominal sensing distance (S <sub>n</sub> ) ± 10%	ORDERING REFERENCES		
												mm	mm	mm
B-3	•	-	43	7	-	50	4	M12 x 1	2	200	2			
D	•	-	50	10	20	80	4	M12 x 1	2	200	2	<b>DCA12/4609KS</b>	<b>DCA12/4619KS</b>	<b>DCA12/4629KS</b>
B-3	•	7	36	7	-	50	4	M12 x 1	1,5	200	4	<b>DCA12/4709KS</b>	<b>DCA12/4719KS</b>	<b>DCA12/4729KS</b>
D	•	7	43	10	20	80	4	M12 x 1	1,5	200	4	<b>DCA12/5609KS</b>	<b>DCA12/5619KS</b>	<b>DCA12/5629KS</b>
												<b>DCA12/5709KS</b>	<b>DCA12/5719KS</b>	<b>DCA12/5729KS</b>

### NPN (negative switching)

Use the above mentioned part number changing the last number 9 with 8 (ie DCA12/4608KS)

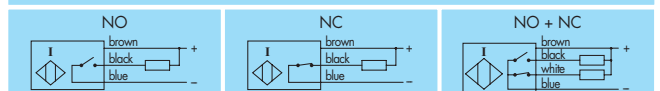

# CYLINDRICAL INDUCTIVE SENSORS IN METAL HOUSING

- Diameters 18 mm
- Amplified in d.c. 3 and 4 wires
- Cable output

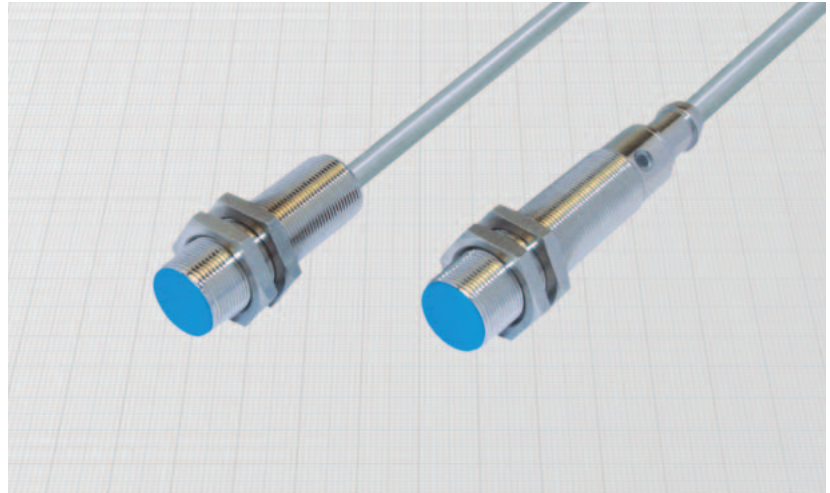
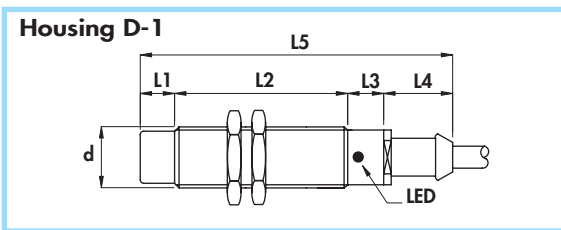
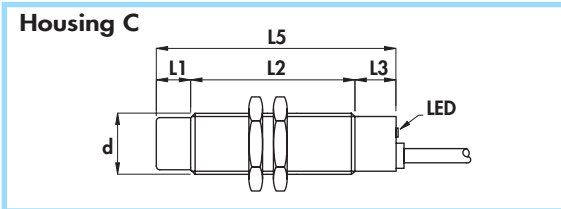
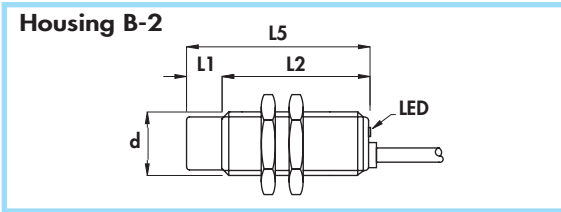

Diameter	M18 x 1	
Nut	Size	SW24
	Thickness mm	4
Max tightening torque Nm	35	

### Materials:

- Cable: 2 m PVC CEI 20 - 22 II; 90°C; 300 V; O.R.
- Housing: nickel plated brass
- Sensing face: plastic

### Technical data:

- Supply voltage ( $U_B$ ): 5 ÷ 60 V
- Max ripple: 10%
- No-load supply current ( $I_0$ ): ≤ 10 mA
- Voltage drop ( $U_d$ ): ≤ 2,2 V
- Temperature range: - 25° ÷ + 75°C
- Max thermal drift of sensing distance  $S_s$ : ± 10%
- Repeat accuracy (R): 2%
- Switching hysteresis (H): 10%
- Degree of protection: IP67
- Switch status indicator: yellow LED
- Cable conductor cross section: 0,50 mm<sup>2</sup>
- Protected against short-circuit and overload
- Protected against any wrong connection
- Suppression of initial false impulse
- Electromagnetic compatibility (EMC) according to EN60947-5-2
- Shock and vibration resistance according to EN60068-2-27 EN60068-2-6

Housing	Flush mounting Non flush mounting	L1	L2	L3	L4	L5	Cable diameter	Body diameter (d)	Max switching frequency (f)	No-load supply current (I <sub>0</sub> )	Nominal sensing distance (S <sub>n</sub> ) ± 10%	ORDERING REFERENCES		
												PNP (positive switching)		
												NO	NC	NO + NC
B-2	•	-	50	-	-	50	5	M18 x 1	1	400	5	<b>DCA18/4A09KS</b>	<b>DCA18/4A19KS</b>	<b>DCA18/4A29KS</b>
B-2	•	10	40	-	-	50	5	M18 x 1	1	400	8	<b>DCA18/5A09KS</b>	<b>DCA18/5A19KS</b>	<b>DCA18/5A29KS</b>
C	•	-	58	12	-	70	5	M18 x 1	1	400	5	<b>DCA18/4609KS</b>	<b>DCA18/4619KS</b>	<b>DCA18/4629KS</b>
D-1	•	-	60	12	20	92	6	M18 x 1	1	400	5	<b>DCA18/4709KS</b>	<b>DCA18/4719KS</b>	<b>DCA18/4729KS</b>
C	•	10	48	12	-	70	5	M18 x 1	1	400	8	<b>DCA18/5609KS</b>	<b>DCA18/5619KS</b>	<b>DCA18/5629KS</b>
D-1	•	10	50	12	20	92	6	M18 x 1	1	400	8	<b>DCA18/5709KS</b>	<b>DCA18/5719KS</b>	<b>DCA18/5729KS</b>
												NPN (negative switching)		
												Use the above mentioned part number changing the last number 9 with 8 (ie DCA18/4A08KS)		
												NO	NC	NO + NC



# CYLINDRICAL INDUCTIVE SENSORS IN METAL HOUSING

- Diameters 30 - 45 mm •
- Amplified in d.c. 3 and 4 wires •
- Cable output •

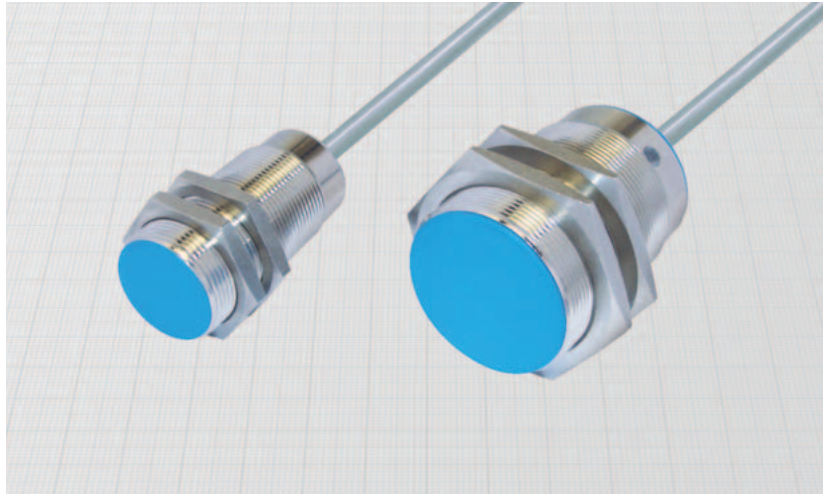
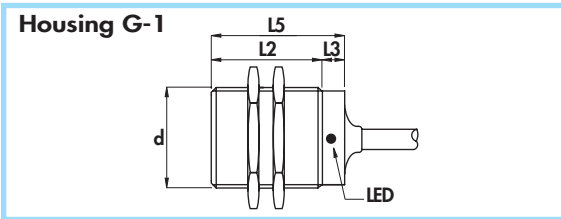
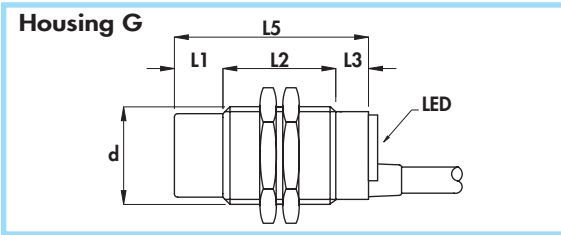
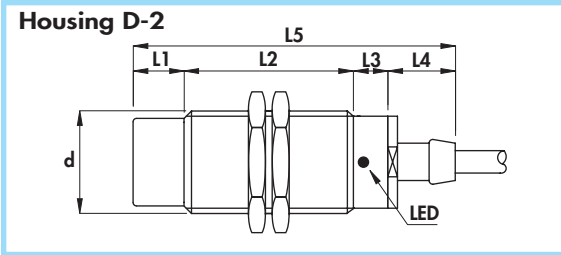

Diameter	M30 x 1,5	M45 x 1,5
Nut	Size	SW36
	Thickness mm	5
Max tightening torque Nm	80	70

### Materials:

- Cable: 2 m PVC CEI 20 - 22 II; 90°C; 300 V; O.R.
- Housing: nickel plated brass
- Sensing face: plastic

### Technical data:

- Supply voltage ( $U_B$ ): 7 ÷ 60 Vdc
- Max ripple: 10%
- No-load supply current ( $I_0$ ): ≤ 10 mA
- Voltage drop ( $U_d$ ): ≤ 2,2 V
- Temperature range: -25° ÷ +75°C
- Max thermal drift of sensing distance  $S_T$ : ± 10%
- Repeat accuracy (R): 2%
- Switching hysteresis (H): 10%
- Degree of protection: IP67
- Switch status indicator: yellow LED
- Cable conductor cross section: 0,50 mm<sup>2</sup>
- Protected against short-circuit and overload
- Protected against any wrong connection
- Suppression of initial false impulse
- Electromagnetic compatibility (EMC) according to EN60947-5-2
- Shock and vibration resistance according to EN60068-2-27 EN60068-2-6



Housing	Flush mounting Non flush mounting	L1	L2	L3	L4	L5	Cable diameter	Body diameter (d)	Max switching frequency (f)	No-load supply current (I <sub>0</sub> )	Nominal sensing distance (S <sub>n</sub> ) ± 10%	ORDERING REFERENCES		
												PNP (positive switching)		
												NO	NC	NO + NC
												brown	brown	brown
												black	black	black
												blue	blue	white
												blue	blue	blue
G	•	-	50	10	-	60	6	M30 x 1,5	0,8	400	10	<b>DCA30/4609KS</b>	<b>DCA30/4619KS</b>	<b>DCA30/4629KS</b>
D-2	•	-	65	10	20	95	6	M30 x 1,5	0,8	400	10	<b>DCA30/4709KS</b>	<b>DCA30/4719KS</b>	<b>DCA30/4729KS</b>
G	•	15	35	10	-	60	6	M30 x 1,5	0,4	400	15	<b>DCA30/5609KS</b>	<b>DCA30/5619KS</b>	<b>DCA30/5629KS</b>
D-2	•	15	50	10	20	95	6	M30 x 1,5	0,4	400	15	<b>DCA30/5709KS</b>	<b>DCA30/5719KS</b>	<b>DCA30/5729KS</b>
G-1	•	-	50	10	-	60	6	M45 x 1,5	0,15	400	20	<b>DCA45/4609KS</b>	<b>DCA45/4619KS</b>	<b>DCA45/4629KS</b>
												NPN (negative switching)		
												Use the above mentioned part number changing the last number 9 with 8 (ie DCA30/4608KS)		
												NO	NC	NO + NC
												brown	brown	brown
												black	black	black
												blue	blue	white
												blue	blue	blue

# CYLINDRICAL INDUCTIVE SENSORS IN METAL HOUSING

- Diameters 4 - 5 - 6,5 - 8 mm
- Amplified in c.c.
- Connector output M8 x 1

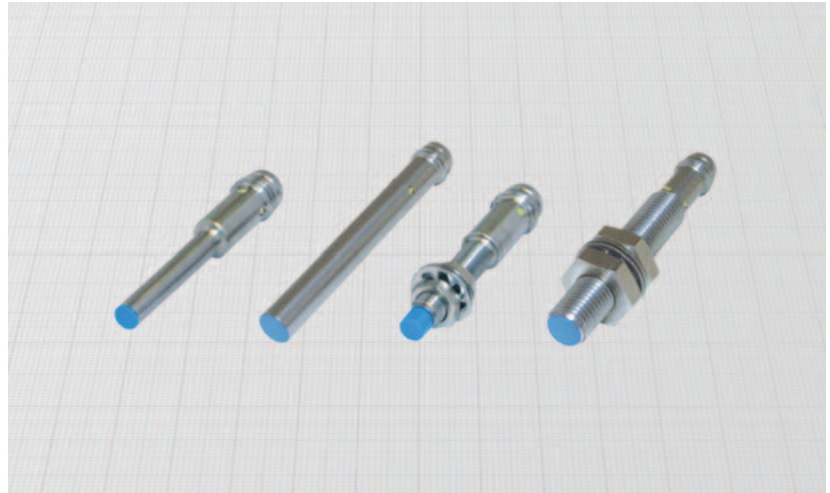
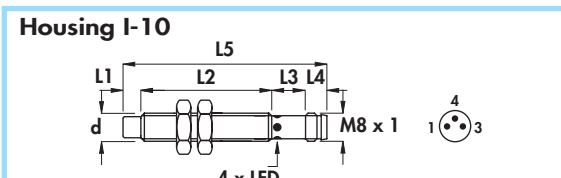
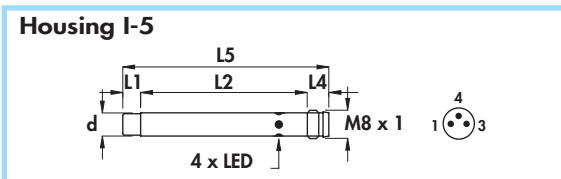
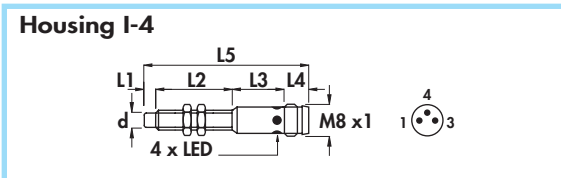
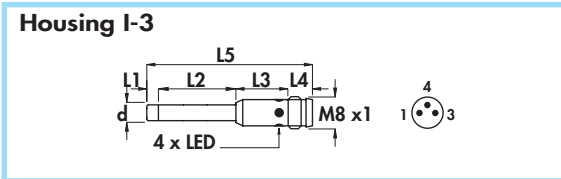

Diameter	M5x0,5	M8 x 1
Nut	Size	SW7
	Thickness mm	2,5
Max tightening torque Nm	2	10

## Materials:

- Housing: stainless steel
- Sensing face: plastic

## Technical data:

- Supply voltage ( $U_B$ ): 7 ÷ 30 Vdc
- Max ripple: 10%
- No-load supply current ( $I_0$ ): ≤ 10 mA
- Voltage drop ( $U_d$ ): ≤ 1,5 V
- Temperature range: -25° ÷ +70°C
- Max thermal drift of sensing distance  $S_s$ : ± 10%
- Repeat accuracy (R): 2%
- Switching hysteresis (H): 10%
- Degree of protection: IP67
- Switch status indicator: yellow LED
- Protected against short-circuit and overload
- Protected against any wrong connection
- Suppression of initial false impulse
- Electromagnetic compatibility (EMC) according to EN60947-5-2
- Shock and vibration resistance according to EN60068-2-27 EN60068-2-6

Housing	Flush mounting Non flush mounting	L1	L2	L3	L4	L5	Female connector	Body diameter (d)	Max switching frequency (f)	Rated operational current (I <sub>o</sub> )	Nominal sensing distance (S <sub>s</sub> ) ± 10%	ORDERING REFERENCES	
												mm	mm
I-3	•	-	22	12	5,5	39,5	11-12	4	5	200	1		
I-3	•	3	19	12	5,5	39,5	11-12	4	5	200	1,4		
I-4	•	-	22	12	5,5	39,5	11-12	M5 x 0,5	5	200	1		
I-4	•	3	19	12	5,5	39,5	11-12	M5 x 0,5	5	200	1,4		
I-5	•	-	48,5	-	5,5	54	11-12	6,5	4	200	1,5		
I-5	•	5	43,5	-	5,5	54	11-12	6,5	3	200	2,5		
I-10	•	-	40	8,5	5,5	54	11-12	M8 x 1	4	200	1,5		
I-10	•	5	35	8,5	5,5	54	11-12	M8 x 1	3	200	2,5		
												<b>NPN (negative switching)</b> Use the above mentioned part number changing the last number 9 with 8 (ie. DCA4/4908LKS)	

**Diameters 8 - 12 mm •**  
**Amplified in d.c. •**  
**Connector output M12 x 1 •**

## Housing I-11

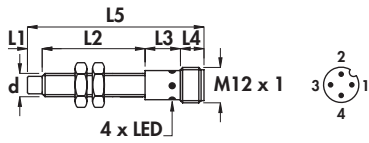

## Housing I-7

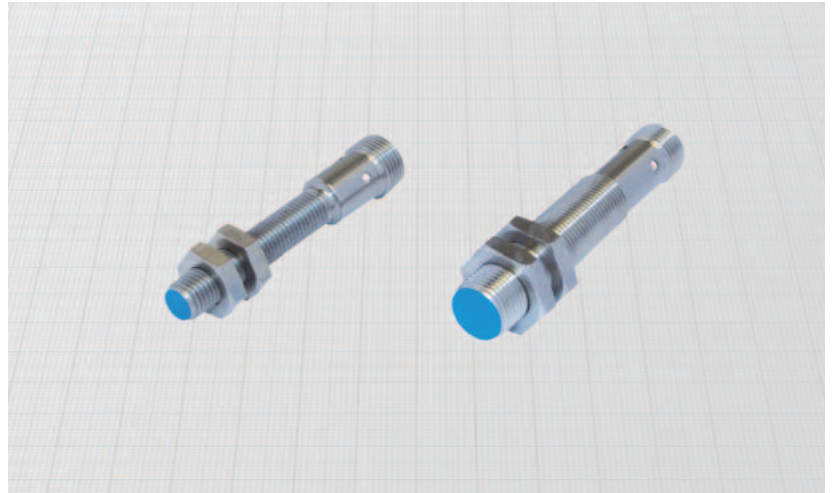
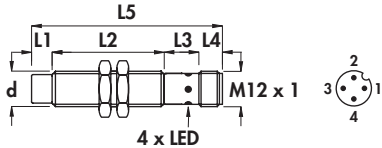

Diameter		M8 x 1	M12 x 1
Nut	Size	SW13	SW17
	Thickness mm	4	4
Max tightening torque Nm		10	15

### Materials:

- Housing diametro 8 mm: stainless steel
- Housing diametro 12 mm: nickel plated brass
- Sensing face: plastic

### Technical data:

- Supply voltage ( $U_B$ ): diameter 8 mm 7 ÷ 30 Vdc  
diameter 12 mm 5 ÷ 40 Vdc
- Max ripple: 10%
- No-load supply current ( $I_o$ ): ≤ 10 mA
- Voltage drop ( $U_d$ ): ≤ 1,5 V
- Temperature range: -25° ÷ +75°C
- Max thermal drift of sensing distance  $S_s$ : ± 10%
- Repeat accuracy (R): 2%
- Switching hysteresis (H): 10%
- Degree of protection: IP67
- Switch status indicator: yellow LED
- Protected against short-circuit and overload
- Protected against any wrong connection
- Suppression of initial false impulse
- Electromagnetic compatibility (EMC) according to EN60947-5-2
- Shock and vibration resistance according to EN60068-2-27 EN60068-2-6

Housing	Flush mounting Non flush mounting	L1	L2	L3	L4	L5	Female connector	Body diameter (d)	Max switching frequency (f)	Rated operational current (I <sub>e</sub> )	Nominal sensing distance (S <sub>n</sub> ) ± 10%	ORDERING REFERENCES		
												PNP (positive switching)		
I-11	•	-	40	12	8	60	6 - 8B-10	M8 x 1	4	200	1,5			
I-11	•	5	35	12	8	60	6 - 8B-10	M8 x 1	3	200	2,5	<b>DCA8/4309KS</b> <b>DCA8/5309KS</b>	<b>DCA8/43C9KS</b> <b>DCA8/53C9KS</b>	<b>DCA8/4329KS</b> <b>DCA8/5329KS</b>
I-7	•	-	43	15	8	66	6 - 8B-10	M12 x 1	2	200	2			
I-7	•	7	36	15	8	66	6 - 8B-10	M12 x 1	1,5	200	4	<b>DCA12/4309KS</b> <b>DCA12/5309KS</b>	<b>DCA12/43C9KS</b> <b>DCA12/53C9KS</b>	<b>DCA12/4329KS</b> <b>DCA12/5329KS</b>
												NPN (negative switching)		
												Use the above mentioned part number changing the last number 9 with 8 (ie DCA8/4308KS)		

# CYLINDRICAL INDUCTIVE SENSORS IN METAL HOUSING

- Diameters 18 - 30 - 45 mm
- Amplified in d.c.
- Connector output M12 x 1

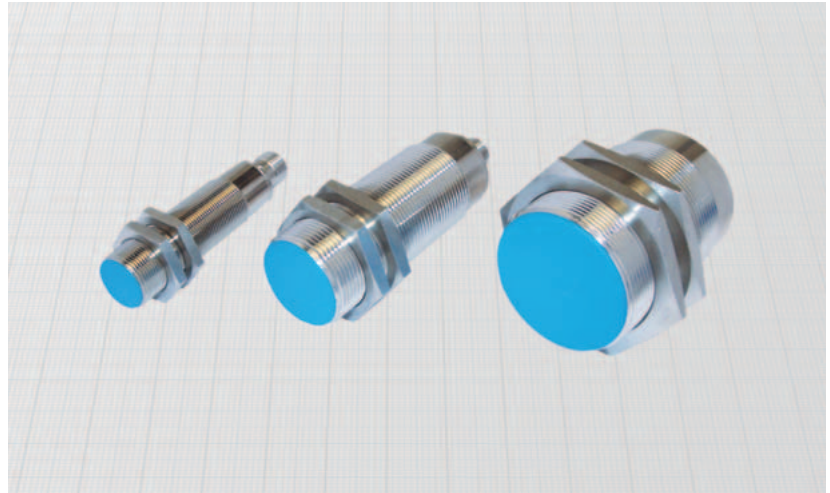
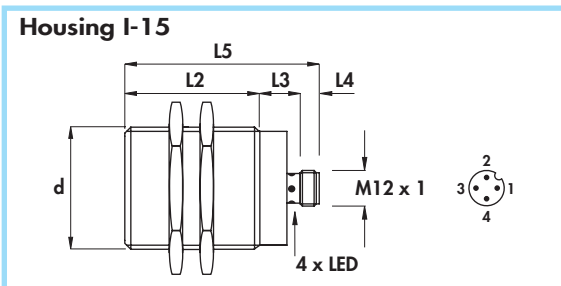
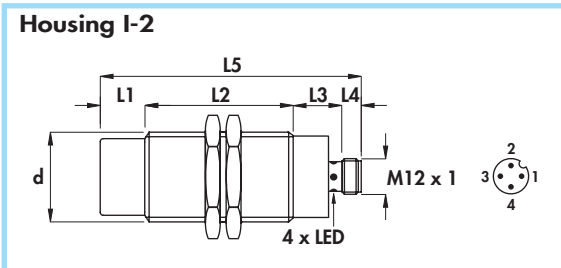
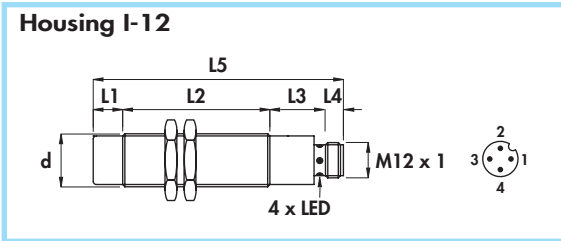

Diameter	M18 x 1	M30 x 1,5	M45 x 1,5
Nut	Size	SW24	SW36
	Thickness mm	4	5
Max tightening torque Nm	35	80	70

**Materials:**

- Housing: nickel plated brass
- Sensing face: plastic

**Technical data:**

- Supply voltage ( $U_B$ ):
  - diameter 18 mm  $5 \div 60$  Vdc
  - diameters 30 and 45 mm  $7 \div 60$  Vdc
- Max ripple: 10%
- No-load supply current ( $I_0$ ):  $\leq 10$  mA
- Voltage drop ( $U_d$ ):  $\leq 2,2$  V
- Temperature range:  $-25^\circ \div +75^\circ\text{C}$
- Max thermal drift of sensing distance  $S_T$ :  $\pm 10\%$
- Repeat accuracy (R): 2%
- Switching hysteresis (H): 10%
- Degree of protection: IP67
- Switch status indicator: yellow LED
- Protected against short-circuit and overload
- Protected against any wrong connection
- Suppression of initial false impulse
- Electromagnetic compatibility (EMC) according to EN60947-5-2
- Shock and vibration resistance according to EN60068-2-27 EN60068-2-6

Housing	Flush mounting Non flush mounting	L1	L2	L3	L4	L5	Female connector	Body diameter (d)	Max switching frequency (f)	Rated operational current (I <sub>e</sub> )	Nominal sensing distance (S <sub>n</sub> ) ±10%	ORDERING REFERENCES		
												PNP (positive switching)		
		mm	mm	mm	mm	mm	n°	mm	KHz	mA	mm	NO	NC	NO + NC
I-12	•	-	50	19	8	77	6-8B-10	M18 x 1	1	400	5			
I-12	•	10	50	19	8	87	6-8B-10	M18 x 1	1	400	8	<b>DCA18/4309KS</b>	<b>DCA18/43C9KS</b>	<b>DCA18/4329KS</b>
												<b>DCA18/5309KS</b>	<b>DCA18/53C9KS</b>	<b>DCA18/5329KS</b>
I-2	•	-	65	17	8	90	6-8B-10	M30 x 1,5	0,8	400	10	<b>DCA30/4309KS</b>	<b>DCA30/43C9KS</b>	<b>DCA30/4329KS</b>
I-2	•	15	50	17	8	90	6-8B-10	M30 x 1,5	0,4	400	15	<b>DCA30/5309KS</b>	<b>DCA30/53C9KS</b>	<b>DCA30/5329KS</b>
I-15	•	-	50	19	8	77	6-8B-10	M45 x 1,5	0,15	400	20	<b>DCA45/4309KS</b>	<b>DCA45/43C9KS</b>	<b>DCA45/4329KS</b>

**NPN (negative switching)**

Use the above mentioned part number changing the last number 9 with 8 (ie DCA18/4308KS)

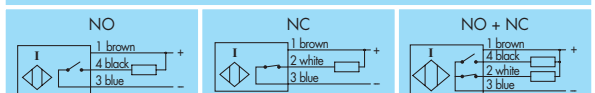



# CYLINDRICAL INDUCTIVE SENSORS IN METAL HOUSING

- Diameter 18 mm •
- Amplified in d.c. •
- Connector output C1 - C2 •

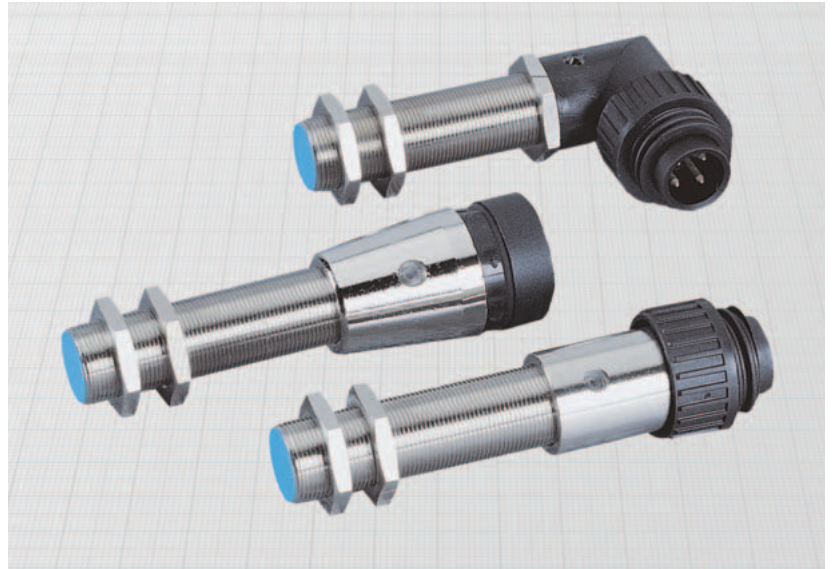
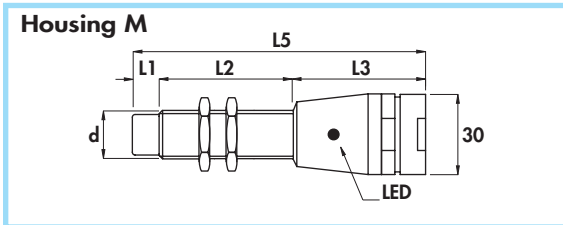
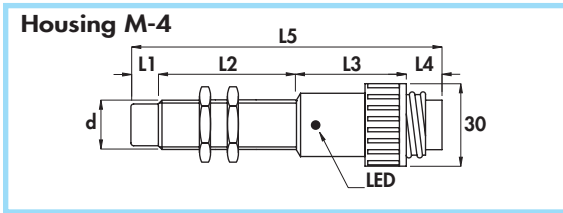
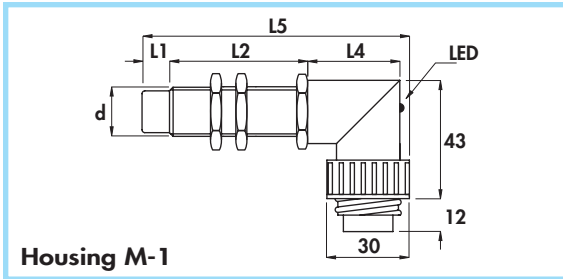

Diameter	M18 x 1	
Nut	Size	SW24
	Thickness mm	4
Max tightening torque Nm	35	

**Materials:**

- Housing: nickel plated brass
- Sensing face and socket connector: plastic

**Technical data:**

- Supply voltage ( $U_B$ ):  $5 \div 60$  Vdc
- Max ripple: 10%
- No-load supply current ( $I_0$ ):  $\leq 10$  mA
- Voltage drop ( $U_d$ ):  $\leq 2,2$  V
- Temperature range:  $-25^\circ \div +75^\circ$  C
- Max thermal drift of sensing distance  $S_T$ :  $\pm 10\%$
- Repeat accuracy (R): 2%
- Switching hysteresis (H): 10%
- Degree of protection: IP65
- Switch status indicator: yellow LED
- Protected against short-circuit and overload
- Protected against any wrong connection
- Suppression of initial false impulse
- Electromagnetic compatibility (EMC) according to EN60947-5-2
- Shock and vibration resistance according to EN60068-2-27 EN60068-2-6

Housing	Mounting	L1	L2	L3	L4	L5	Female connector	Body diameter (d)	Max switching frequency (f)	Rated operational current (I <sub>e</sub> )	Nominal sensing distance (S <sub>T</sub> ) ±10%	ORDERING REFERENCES	
												PNP (positive switching)	
M-1	Flush mounting	-	60	-	33	96	1	M18 x 1	1	400	5		
M-4	Non flush mounting	-	60	40	13	113	1	M18 x 1	1	400	5		
M-1	Flush mounting	10	50	-	33	96	1	M18 x 1	1	400	8		
M-4	Non flush mounting	10	50	40	13	113	1	M18 x 1	1	400	8		

**NPN (negative switching)**  
Use the above mentioned part number changing the last number 9 with 8 (ie DCA18/4208KS)

		NO		NC	

**PNP (positive switching)**

		NO		NC		NO + NC	

Housing	Mounting	L1	L2	L3	L4	L5	n°	mm	KHz	mA	mm	NO	NC	NO + NC
M	Flush mounting	-	60	50	-	110	2	M18 x 1	1	400	5	DCA18/4E09KS	DCA18/4E19KS	DCA18/4E29KS
M	Non flush mounting	10	50	50	-	110	2	M18 x 1	1	400	8	DCA18/5E09KS	DCA18/5E19KS	DCA18/5E29KS

**NPN (negative switching)**  
Use the above mentioned part number changing the last number 9 with 8 (ie DCA18/4E08KS)

		NO		NC		NO + NC	

# CYLINDRICAL INDUCTIVE SENSORS IN METAL HOUSING

- Diameter 30 mm
- Amplified in d.c.
- Connector output C1 - C2

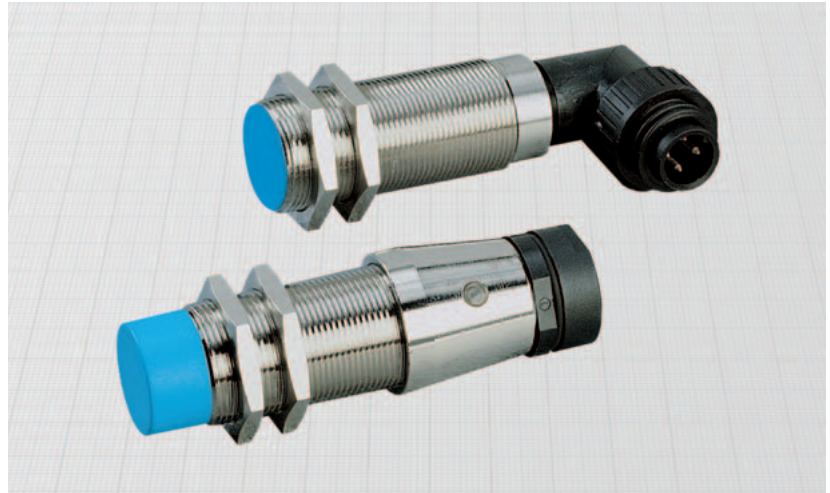
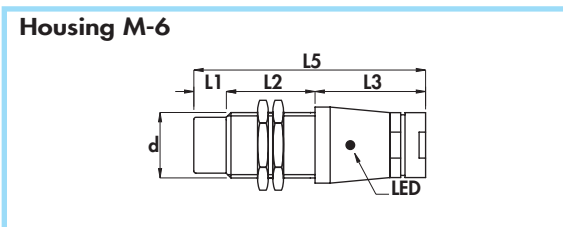
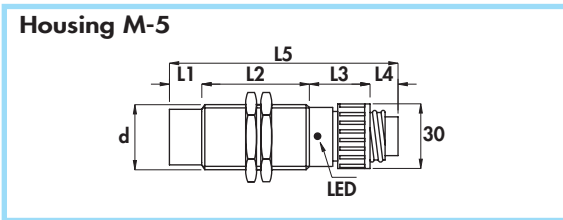
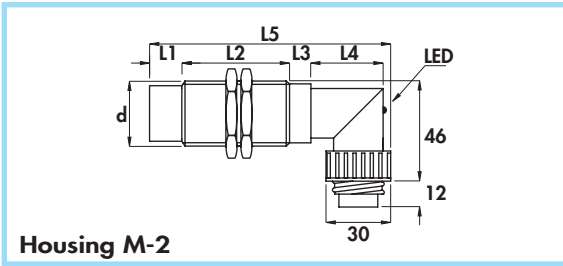

Diameter	M30 x 1,5	
Nut	Size	SW36
	Thickness mm	5
Max tightening torque Nm	80	

### Materials:

- Housing: nickel plated brass
- Sensing face and socket connector: plastic

### Technical data:

- Supply voltage ( $U_b$ ): 7 ÷ 60 Vdc
- Max ripple: 10%
- No-load supply current ( $I_o$ ): ≤ 10 mA
- Voltage drop ( $U_d$ ): ≤ 2,2 V
- Temperature range: - 25° ÷ + 75°C
- Max thermal drift of sensing distance  $S_T$ : ± 10%
- Repeat accuracy (R): 2%
- Switching hysteresis (H): 10%
- Degree of protection: IP65
- Switch status indicator: yellow LED
- Protected against short-circuit and overload
- Protected against any wrong connection
- Suppression of initial false impulse
- Electromagnetic compatibility (EMC) according to EN60947-5-2
- Shock and vibration resistance according to EN60068-2-27 EN60068-2-6

Housing	Flush mounting Non flush mounting	L1	L2	L3	L4	L5	Female connector	Body diameter (d)	Max switching frequency (f)	No-load supply current (I <sub>o</sub> )	Nominal sensing distance (S <sub>T</sub> ) ±10%	ORDERING REFERENCES			
		mm	mm	mm	mm	mm						n°	mm	KHz	mA
M-2	•	-	65	10	40	115	1	M30 x 1,5	0,8	400	10			<b>DCA30/4209KS</b>	<b>DCA30/4219KS</b>
M-5	•	-	65	28	13	106	1	M30 x 1,5	0,8	400	10			<b>DCA30/4409KS</b>	<b>DCA30/4419KS</b>
M-2	•	15	50	10	40	115	1	M30 x 1,5	0,4	400	15			<b>DCA30/5209KS</b>	<b>DCA30/5219KS</b>
M-5	•	15	50	28	13	106	1	M30 x 1,5	0,4	400	15			<b>DCA30/5409KS</b>	<b>DCA30/5419KS</b>

### NPN (negative switching)

Use the above mentioned part number changing the last number 9 with 8 (ie DCA30/4208KS)



### PNP (positive switching)

Housing	Flush mounting Non flush mounting	L1	L2	L3	L4	L5	Female connector	Body diameter (d)	Max switching frequency (f)	No-load supply current (I <sub>o</sub> )	Nominal sensing distance (S <sub>T</sub> ) ±10%	ORDERING REFERENCES					
		mm	mm	mm	mm	mm						n°	mm	KHz	mA	mm	PNP (positive switching)
M-6	•	-	56	51	-	107	2	M30 x 1,5	0,8	400	10				<b>DCA30/4E09KS</b>	<b>DCA30/4E19KS</b>	<b>DCA30/4E29KS</b>
M-6	•	15	41	51	-	107	2	M30 x 1,5	0,4	400	15				<b>DCA30/5E09KS</b>	<b>DCA30/5E19KS</b>	<b>DCA30/5E29KS</b>

### NPN (negative switching)

Use the above mentioned part number changing the last number 9 with 8 (ie. DCA30/4E08KS)

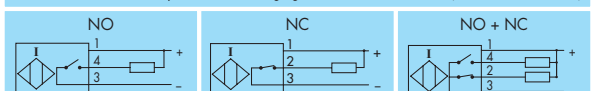

Diameter 45 mm •  
 Amplified in d.c. •  
 Connector output C1 - C2 •

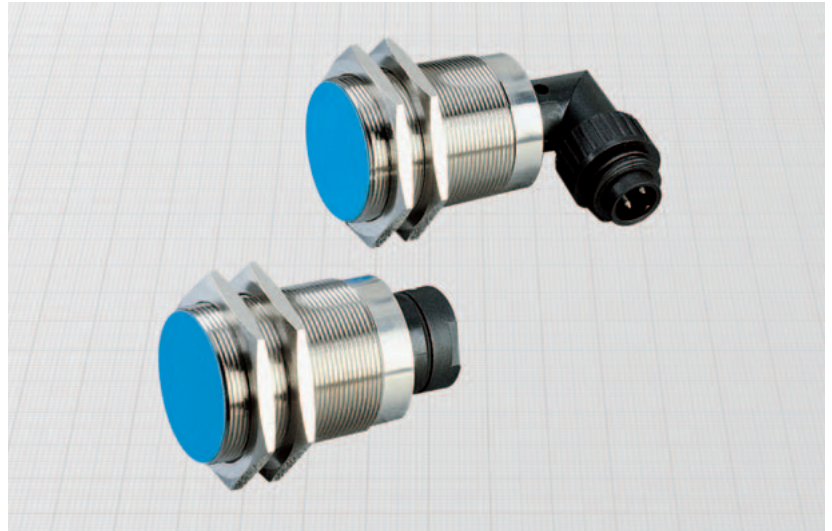
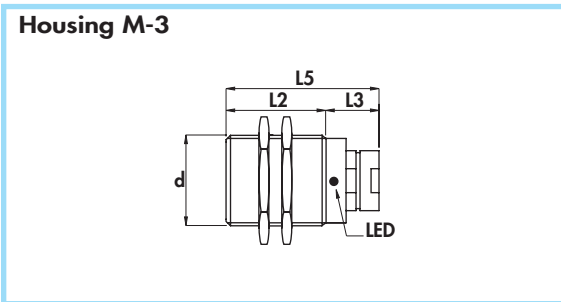
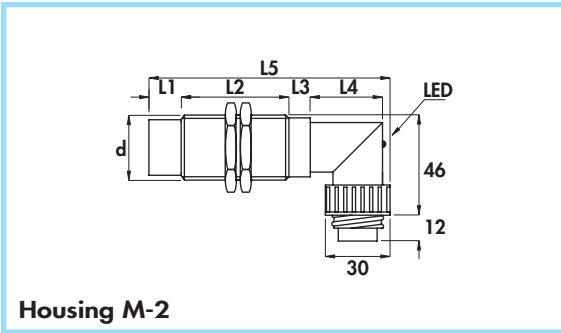

Diameter	M45 x 1,5	
Nut	Size	SW55
	Thickness mm	5
Max tightening torque Nm	70	

**Materials:**

- Housing: nickel plated brass
- Sensing face and socket connector: plastic

**Technical data:**

- Supply voltage ( $U_B$ ):  $7 \div 60$  Vdc
- Max ripple: 10%
- No-load supply current ( $I_0$ ):  $\leq 10$  mA
- Voltage drop ( $U_d$ ):  $\leq 2,2$  V
- Temperature range:  $-25^\circ \div +75^\circ$  C
- Max thermal drift of sensing distance  $S_T$ :  $\pm 10\%$
- Repeat accuracy (R): 2%
- Switching hysteresis (H): 10%
- Degree of protection: IP65
- Switch status indicator: yellow LED
- Protected against short-circuit and overload
- Protected against any wrong connection
- Suppression of initial false impulse
- Electromagnetic compatibility (EMC) according to EN60947-5-2
- Shock and vibration resistance according to EN60068-2-27 EN60068-2-6

Housing	Mounting	L1	L2	L3	L4	L5	Female connector	Body diameter (d)	Max switching frequency (f)	Rated operational current (I <sub>e</sub> )	Nominal sensing distance (S <sub>T</sub> ) ± 10%	ORDERING REFERENCES	
												PNP (positive switching)	
M-2	•	-	50	10	42	102	1	M45 x 1,5	0,15	400	20	 NO	 NC
												<b>DCA45/4209KS</b>	<b>DCA45/4219KS</b>
M-2	•	-	50	10	42	102	1	M45 x 1,5	0,15	400	20	NPN (negative switching) Use the above mentioned part number changing the last number 9 with 8 (ie DCA45/4208KS)	
												 NO	 NC
M-3	•	-	50	28	-	78	2	M45 x 1,5	0,15	400	20	PNP (positive switching)	
												 NO	 NC
M-3	•	-	50	28	-	78	2	M45 x 1,5	0,15	400	20	NPN (negative switching) Use the above mentioned part number changing the last number 9 with 8 (ie DCA45/4E08KS)	
												 NO	 NC

# CYLINDRICAL INDUCTIVE SENSORS IN METAL HOUSING

- **SHORT SERIES**
- **Amplified in d.c. 3 wires**
- **Cable output**

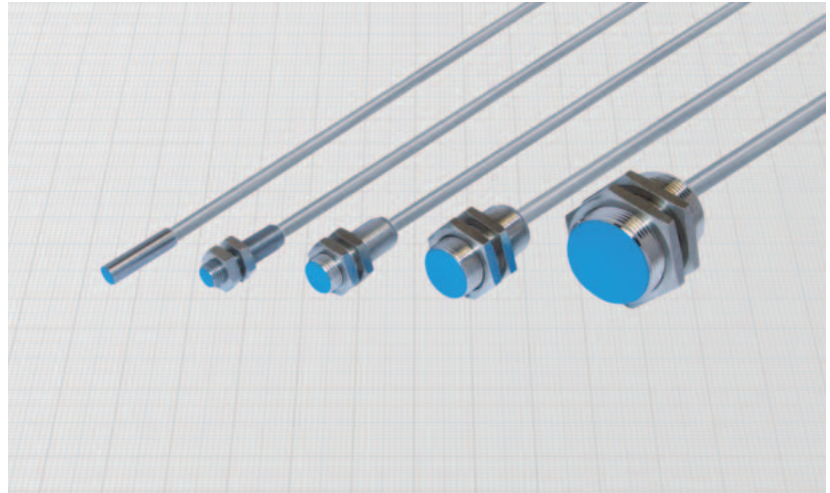
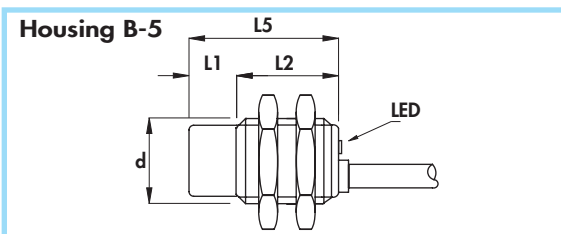
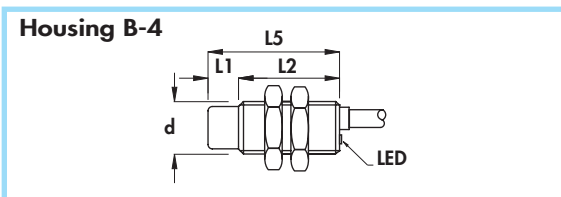
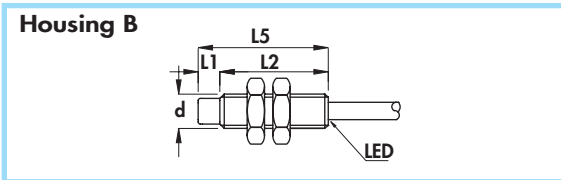
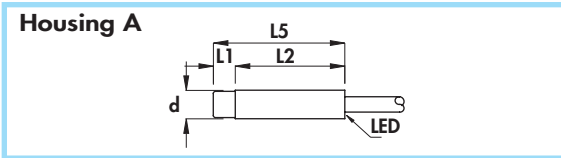

Diameter		M8 x 1	M12 x 1	M18 x 1	M30 x 1,5
Nut	Size	SW13	SW17	SW24	SW36
	Thickness mm	4	4	4	5
Max tightening torque Nm		10	15	35	80

## Materials:

- Cable: 2 m PVC CEI 20 - 22 II; 90°C; 300 V; O.R.
- Housing 6,5 and 8 mm: stainless steel
- Housing 12 ÷ 30 mm: nickel plated brass
- Sensing face: plastic

## Technical data:

- Supply voltage ( $U_B$ ): see ordering references
- Max ripple: 10%
- No-load supply current ( $I_0$ ):  $\leq 10$  mA
- Voltage drop ( $U_d$ ):  $\leq 1,5$  V
- Temperature range:  $-25^\circ \div +70^\circ\text{C}$
- Max thermal drift of sensing distance  $S_s$ :  $\pm 10\%$
- Repeat accuracy (R): 2%
- Switching hysteresis (H): 10%
- Degree of protection: IP67
- Switch status indicator: yellow LED
- Cable conductor cross section: 0,22 mm<sup>2</sup> on 6,5 and 8 mm  
0,35 mm<sup>2</sup> on 12 mm  
0,50 mm<sup>2</sup> on 18 and 30 mm

- Protected against short-circuit and overload
- Protected against any wrong connection
- Suppression of initial false impulse
- Electromagnetic compatibility (EMC) according to EN60947-5-2
- Shock and vibration resistance according to EN60068-2-27 EN60068-2-6

Housing	Flush mounting Non flush mounting	L1	L2	L3	L4	L5	Cable diameter	Body diameter (d)	Supply voltage ( $U_B$ )	Max switching frequency (f)	No-load supply current ( $I_0$ )	Nominal sensing distance ( $S_n \pm 10\%$ )	ORDERING REFERENCES	
													PNP (positive switching)	
A	•	-	30	-	-	30	3,5	6,5	7 ÷ 30	4	200	1,5		
A	•	5	25	-	-	30	3,5	6,5	7 ÷ 30	3	200	2,5	<b>DSA6,5/4609LKS</b> <b>DSA6,5/5609LKS</b>	<b>DSA6,5/4619LKS</b> <b>DSA6,5/5619LKS</b>
B	•	-	30	-	-	30	3,5	M8 x 1	7 ÷ 30	4	200	1,5	<b>DSA8/4609KS</b>	<b>DSA8/4619KS</b>
B	•	5	25	-	-	30	3,5	M8 x 1	7 ÷ 30	3	200	2,5	<b>DSA8/5609KS</b>	<b>DSA8/5619KS</b>
B-4	•	-	30	-	-	30	4	M12 x 1	7 ÷ 40	2	200	2	<b>DSA12/4609KS</b>	<b>DSA12/4619KS</b>
B-4	•	7	23	-	-	30	4	M12 x 1	7 ÷ 40	1,5	200	4	<b>DSA12/5609KS</b>	<b>DSA12/5619KS</b>
B-5	•	-	30	-	-	30	5	M18 x 1	5 ÷ 40	0,8	200	5	<b>DSA18/4609KS</b>	<b>DSA18/4619KS</b>
B-5	•	10	20	-	-	30	5	M18 x 1	5 ÷ 40	0,6	200	8	<b>DSA18/5609KS</b>	<b>DSA18/5619KS</b>
B-5	•	-	35	-	-	35	6	M30 x 1,5	7 ÷ 40	0,8	200	10	<b>DSA30/4609KS</b>	<b>DSA30/4619KS</b>
B-5	•	15	20	-	-	35	6	M30 x 1,5	7 ÷ 40	0,4	200	15	<b>DSA30/5609KS</b>	<b>DSA30/5619KS</b>

## NPN (negative switching)

Use the above mentioned part number changing the last number 9 with 8 (ie. DSA6,5/4608LKS)

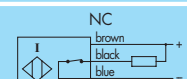
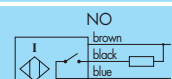



**SHORT SERIES - diameters 6,5 - 8 mm •**  
**Amplified in d.c. •**  
**Connector output M8 x 1 •**

**Housing I-8**

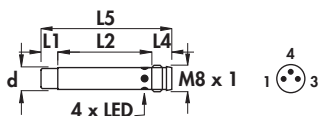

**Housing I-6**

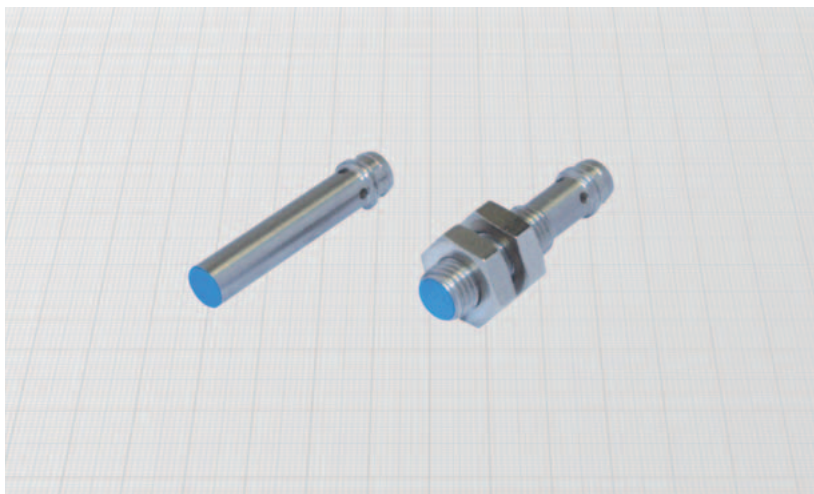
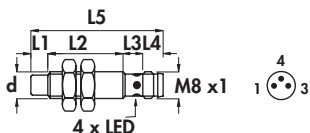

Diameter	M8 x 1	
Nut	Size	SW13
	Thickness mm	4
Max tightening torque Nm	10	

**Materials:**

- Housing: stainless steel
- Sensing face: plastic

**Technical data:**

- Supply voltage ( $U_B$ ):  $7 \div 30$  Vdc
- Max ripple: 10%
- No-load supply current ( $I_0$ ):  $\leq 10$  mA
- Voltage drop ( $U_d$ ):  $\leq 1,5$  V
- Temperature range:  $-25^\circ \div +70^\circ\text{C}$
- Max thermal drift of sensing distance  $S_r$ :  $\pm 10\%$
- Repeat accuracy (R): 2%
- Switching hysteresis (H): 10%
- Degree of protection: IP67
- Switch status indicator: yellow LED
- Protected against short-circuit and overload
- Protected against any wrong connection
- Suppression of initial false impulse
- Electromagnetic compatibility (EMC) according to EN60947-5-2
- Shock and vibration resistance according to EN60068-2-27 EN60068-2-6

Housing	Flush mounting Non flush mounting	L1	L2	L3	L4	L5	Female connector	Body diameter (d)	Max switching frequency (f)	Rated operational current (I <sub>e</sub> )	Nominal sensing distance (S <sub>n</sub> ) ± 10%	ORDERING REFERENCES	
												PNP (positive switching)	
												NO	NC
I-8	•	-	29,5	-	5,5	35	11 - 12	6,5	4	200	1,5	<b>DSA6,5/4909LKS</b>	<b>DSA6,5/4919LKS</b>
I-8	•	5	24,5	-	5,5	35	11 - 12	6,5	3	200	2,5	<b>DSA6,5/5909LKS</b>	<b>DSA6,5/5919LKS</b>
I-6	•	-	21	8,5	5,5	35	11 - 12	M8 x 1	4	200	1,5	<b>DSA8/4909KS</b>	<b>DSA8/4919KS</b>
I-6	•	5	16	8,5	5,5	35	11 - 12	M8 x 1	3	200	2,5	<b>DSA8/5909KS</b>	<b>DSA8/5919KS</b>
												NPN (negative switching)	
												Use the above mentioned part number changing the last number 9 with 8 (ie. DCA45/4E08KS)	

# CYLINDRICAL INDUCTIVE SENSORS IN METAL HOUSING

- **SHORT SERIES** - diameters 8 - 12 - 18 - 30 mm
- **Amplified in d.c.**
- Connector output M12 x 1

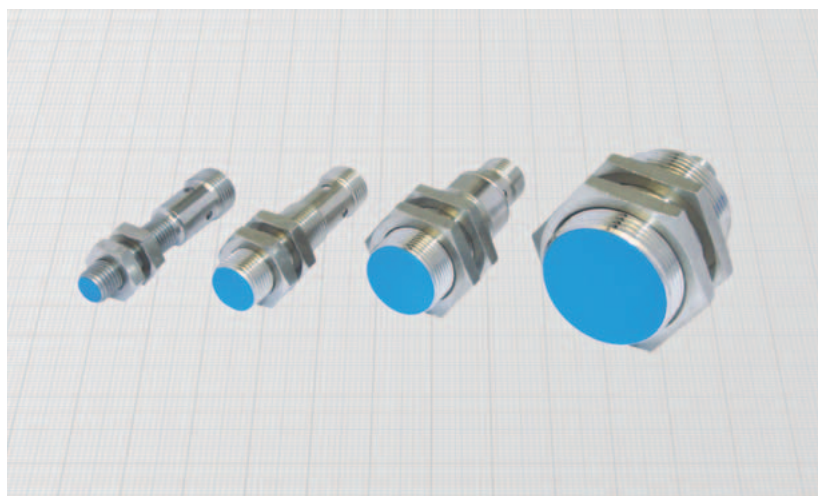
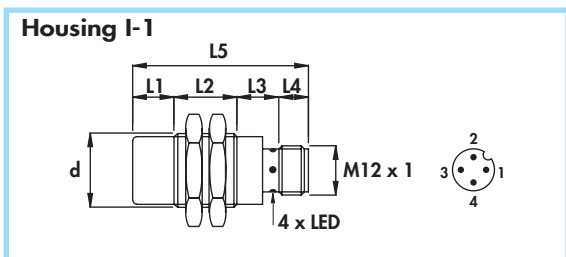
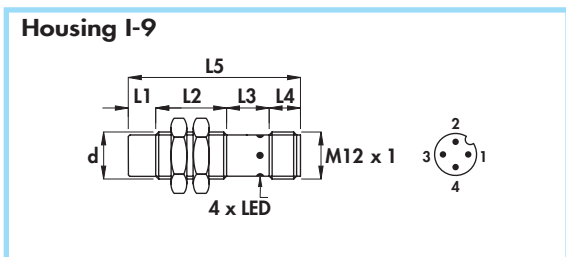
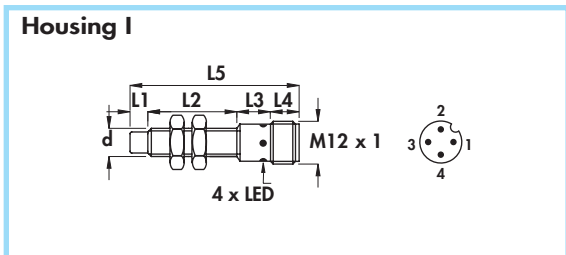

Diameter	M8 x 1	M12 x 1	M18 x 1	M30 x 1,5	
Nut	Size	SW13	SW17	SW24	SW36
	Thickness mm	4	4	4	5
Max tightening torque Nm	10	15	35	80	

**Materials:**

- Housing 8 mm: stainless steel
- Housing 12 ÷ 30 mm: nickel plated brass
- Sensing face: plastic

**Technical data:**

- Supply voltage ( $U_b$ ): see ordering references
- Max ripple: 10%
- No-load supply current ( $I_o$ ):  $\leq 10$  mA
- Voltage drop ( $U_d$ ):  $\leq 1,5$  V
- Temperature range:  $-25^\circ \div +70^\circ$  C
- Max thermal drift of sensing distance  $S_r$ :  $\pm 10\%$
- Repeat accuracy (R): 2%
- Switching hysteresis (H): 10%
- Degree of protection: IP67
- Switch status indicator: yellow LED
- Protected against short-circuit and overload
- Protected against any wrong connection
- Suppression of initial false impulse
- Electromagnetic compatibility (EMC) according to EN60947-5-2
- Shock and vibration resistance according to EN60068-2-27 EN60068-2-6

Housing	Flush mounting Non flush mounting	L1	L2	L3	L4	L5	Female connector	Body diameter (d)	Supply voltage ( $U_b$ )	Max switching frequency (f)	Rated operational current ( $I_e$ )	Nominal sensing distance ( $S_n$ ) $\pm 10\%$	ORDERING REFERENCES	
													PNP (positive switching)	
		mm	mm	mm	mm	mm	n°	mm	V (min - max)	KHz	mA	mm	NO	NC
I	•	-	26	13	8	47	6-8B-10	M8 x 1	7 ÷ 30	4	200	1,5		
	•	5	21	13	8	47	6-8B-10	M8 x 1	7 ÷ 30	3	200	2,5		
I-9	•	-	30	10	8	48	6-8B-10	M12 x 1	7 ÷ 40	2	200	2		
	•	7	23	10	8	48	6-8B-10	M12 x 1	7 ÷ 40	1	200	4		
I-1	•	-	25	16	8	49	6-8B-10	M18 x 1	5 ÷ 40	0,8	200	5		
	•	10	15	16	8	49	6-8B-10	M18 x 1	5 ÷ 40	0,6	200	8		
I-1	•	-	25	17	8	50	6-8B-10	M30 x 1,5	7 ÷ 40	0,8	200	10		
	•	15	25	17	8	65	6-8B-10	M30 x 1,5	7 ÷ 40	0,4	200	15		

**NPN (negative switching)**

Use the above mentioned part number changing the last number 9 with 8 (ie. DSA8/4308KS)



Extended sensing distance - diameters 8 - 12 mm •  
 Amplified in d.c. 3 wires •  
 Cable output •

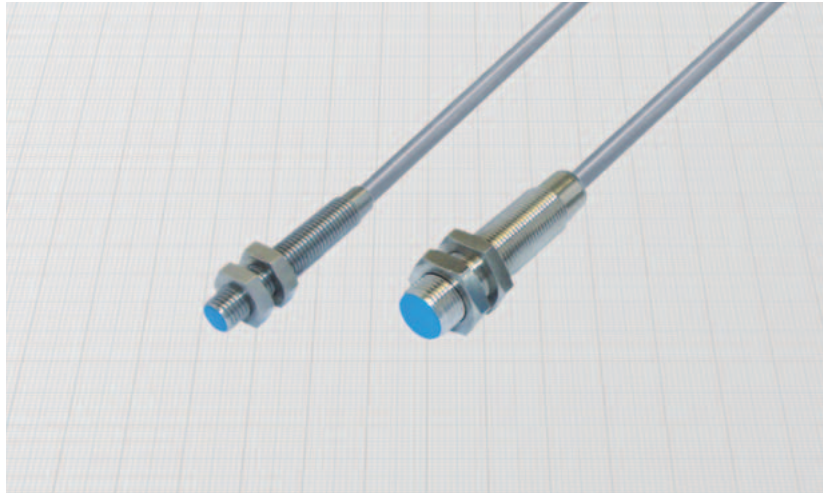
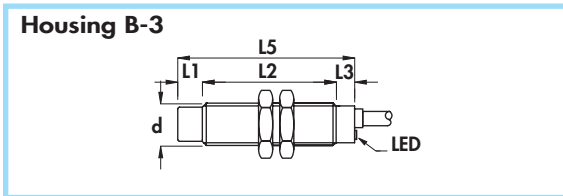
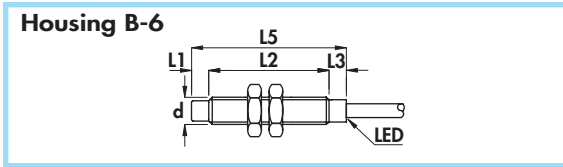

Diameter	M8 x 1	M12 x 1
Nut	Size	SW13
	Thkns mm	4
Max tightening torque Nm	10	15

**Materials:**

- Cable: 2 m PVC CEI 20 - 22 II; 90°C; 300 V; O.R.
- Housing 8 mm: stainless steel
- Housing 12 mm: nickel plated brass
- Sensing face: plastic

**Technical data:**

- Supply voltage ( $U_B$ ): see ordering references
- Max ripple: 10%
- No-load supply current ( $I_0$ ):  $\leq 10$  mA
- Voltage drop ( $U_d$ ):  $\leq 1,5$  V
- Temperature range:  $-20^\circ \div +70^\circ\text{C}$
- Max thermal drift of sensing distance  $S_T$ :  $\pm 10\%$
- Repeat accuracy (R): 4%
- Switching hysteresis (H): 10%
- Degree of protection: IP67
- Switch status indicator: yellow LED
- Cable conductor cross section: 0,22 mm<sup>2</sup> on 8 mm, 0,35 mm<sup>2</sup> on 12 mm
- Protected against short-circuit and overload
- Protected against any wrong connection
- Suppression of initial false impulse
- Electromagnetic compatibility (EMC) according to EN60947-5-2
- Shock and vibration resistance according to EN60068-2-27 EN60068-2-6

www.bdcelectronic.com

Housing	Flush mounting (*) Non flush mounting	L1	L2	L3	L4	L5	Cable diameter	Body diameter (d)	Supply voltage ( $U_B$ )	Max switching frequency (f)	Rated operational current ( $I_e$ )	Nominal sensing distance ( $S_n$ ) $\pm 10\%$	ORDERING REFERENCES	
													PNP (positive switching)	
		mm	mm	mm	mm	mm	mm	mm	V (min - max)	Hz	mA	mm		
B-6	•	-	40	5	-	45	3,5	M8 x 1	7÷30	800	200	2	<b>DCAE8/4609KS</b>	<b>DCAE8/4619KS</b>
B-6	•	-	40	5	-	45	3,5	M8 x 1	7÷30	800	200	2,5	<b>DCE8/4609KS</b>	<b>DCE8/4619KS</b>
B-6	•	5	35	5	-	45	3,5	M8 x 1	7÷30	400	200	3	<b>DCAE8/5609KS</b>	<b>DCAE8/5619KS</b>
B-6	•	5	35	5	-	45	3,5	M8 x 1	7÷30	400	200	3,5	<b>DCE8/5609KS</b>	<b>DCE8/5619KS</b>
B-3	•	-	43	7	-	50	4	M12 x 1	7÷40	800	200	3	<b>DCAE12/4609KS</b>	<b>DCAE12/4619KS</b>
B-3	•	-	43	7	-	50	4	M12 x 1	7÷40	800	200	4	<b>DCE12/4609KS</b>	<b>DCE12/4619KS</b>
B-3	•	7	36	7	-	50	4	M12 x 1	7÷40	600	200	5	<b>DCAE12/5609KS</b>	<b>DCAE12/5619KS</b>
B-3	•	7	36	7	-	50	4	M12 x 1	7÷40	600	200	6	<b>DCE12/5609KS</b>	<b>DCE12/5619KS</b>

(\*) Note: See mounting precautions (pag. 22)

**NPN (negative switching)**  
 Use the above mentioned part number changing the last number 9 with 8 (ie. DCE8/4608KS)



## CYLINDRICAL INDUCTIVE SENSORS IN METAL HOUSING

- Extended sensing distance - diameters 18 - 30 mm
- Amplified in d.c. 3 wires
- Cable output

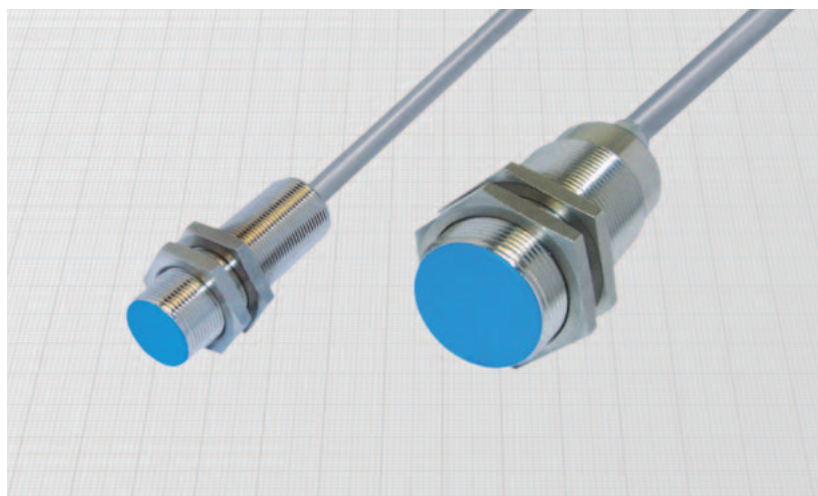
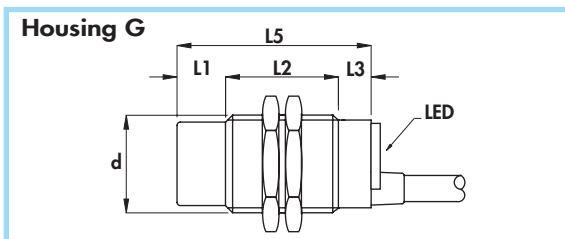
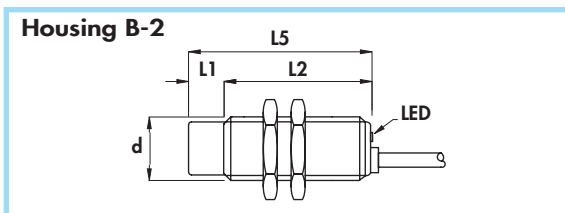

Diameter		M18 x 1	M30 x 1,5
Nut	Size	SW24	SW36
	Thkns mm	4	5
Max tightening torque Nm		35	80

### Materials:

- Cable: 2 m PVC CEI 20 - 22 II; 90°C; 300 V; O.R.
- Housing: nickel plated brass
- Sensing face: plastic

### Technical data:

- Supply voltage ( $U_B$ ): see ordering references
- Max ripple: 10%
- No-load supply current ( $I_0$ ):  $\leq 10$  mA
- Voltage drop ( $U_d$ ):  $\leq 1,5$  V
- Temperature range:  $-20^\circ \div +70^\circ\text{C}$
- Max thermal drift of sensing distance  $S_s$ :  $\pm 10\%$
- Repeat accuracy (R): 4%
- Switching hysteresis (H): 10%
- Degree of protection: IP67
- Switch status indicator: yellow LED
- Cable conductor cross section: 0,50 mm<sup>2</sup>
- Protected against short-circuit and overload
- Protected against any wrong connection
- Suppression of initial false impulse
- Electromagnetic compatibility (EMC) according to EN60947-5-2
- Shock and vibration resistance according to EN60068-2-27 EN60068-2-6

Housing	Flush mounting (*) Non flush mounting	L1	L2	L3	L4	L5	Cable diameter	Body diameter (d)	Supply voltage ( $U_B$ )	Max switching frequency (f)	Rated operational current ( $I_e$ )	Nominal sensing distance ( $S_n$ ) $\pm 10\%$	ORDERING REFERENCES	
													PNP (positive switching)	
		mm	mm	mm	mm	mm	mm	V (min - max)	Hz	mA	mm			
B - 2	•	-	50	-	-	50	5	M18 x 1	7÷40	300	200	8	<b>DCAE18/4A09KS</b>	<b>DCAE18/4A19KS</b>
B - 2	•	-	50	-	-	50	5	M18 x 1	7÷40	300	200	10	<b>DCE18/4A09KS</b>	<b>DCE18/4A19KS</b>
B - 2	•	10	40	-	-	50	5	M18 x 1	7÷40	200	200	12	<b>DCAE18/5A09KS</b>	<b>DCAE18/5A19KS</b>
B - 2	•	10	40	-	-	50	5	M18 x 1	7÷40	200	200	14	<b>DCE18/5A09KS</b>	<b>DCE18/5A19KS</b>
G	•	-	50	10	-	60	6	M30 x 1,5	7÷40	100	200	15	<b>DCAE30/4609KS</b>	<b>DCAE30/4619KS</b>
G	•	-	50	10	-	60	6	M30 x 1,5	7÷40	100	200	20	<b>DCE30/4609KS</b>	<b>DCE30/4619KS</b>
G	•	15	35	10	-	60	6	M30 x 1,5	7÷40	100	200	20	<b>DCAE30/5609KS</b>	<b>DCAE30/5619KS</b>
G	•	15	35	10	-	60	6	M30 x 1,5	7÷40	100	200	28	<b>DCE30/5609KS</b>	<b>DCE30/5619KS</b>

(\*) Note: See mounting precautions (pag. 22)

**NPN (negative switching)**  
Use the above mentioned part number changing the last number 9 with 8 (ie. DCE8/4608KS)





- Extended sensing distance •
- Amplified in d.c. •
- Connector output M8 x 1 •

## Housing I-5

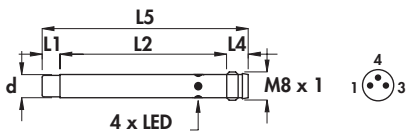

## Housing I-10

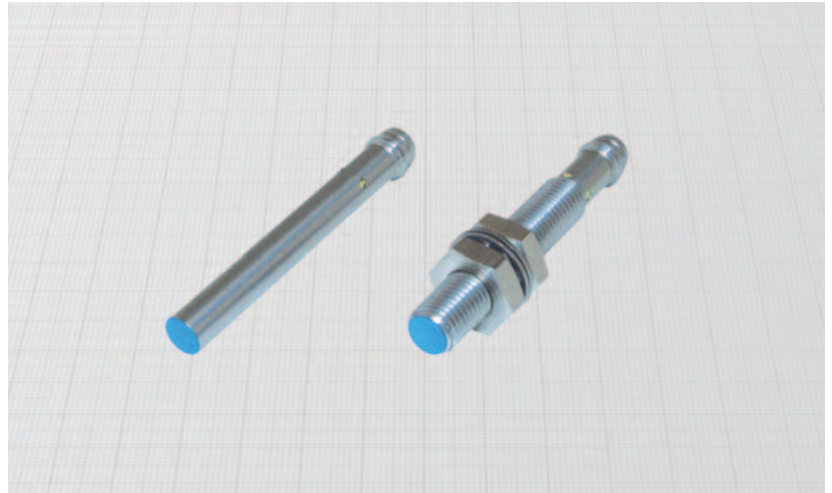
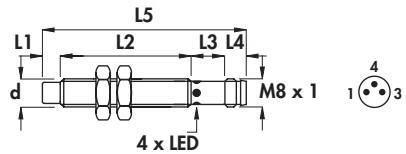

Diameter	M8 x 1	
Nut	Size	SW13
	Thickness mm	4
Max tightening torque Nm	10	

### Materials:

- Housing: stainless steel
- Sensing face: plastic

### Technical data:

- Supply voltage ( $U_B$ ): 7 ÷ 30 Vdc
- Max ripple: 10%
- No-load supply current ( $I_0$ ): ≤ 10 mA
- Voltage drop ( $U_d$ ): ≤ 1,5 V
- Temperature range: -20° ÷ +70°C
- Max thermal drift of sensing distance  $S_T$ : ± 10%
- Repeat accuracy (R): 4%
- Switching hysteresis (H): 10%
- Degree of protection: IP67
- Switch status indicator: yellow LED
- Protected against short-circuit and overload
- Protected against any wrong connection
- Suppression of initial false impulse
- Electromagnetic compatibility (EMC) according to EN60947-5-2
- Shock and vibration resistance according to EN60068-2-27 EN60068-2-6

www.bdc-electronic.com

Housing	Flush mounting (*) Non flush mounting	L1	L2	L3	L4	L5	Female connector	Body diameter (d)	Max switching frequency (f)	Rated operational current (I <sub>e</sub> )	Nominal sensing distance (S <sub>n</sub> ) ± 10%	ORDERING REFERENCES	
												PNP (positive switching)	
		mm	mm	mm	mm	mm	n°	mm	Hz	mA	mm		
I-5	•	-	48,5	-	5,5	54	11 - 12	6,5	800	200	2	<b>DCAE6,5/4909LKS</b>	<b>DCAE6,5/4919LKS</b>
I-5	•	-	48,5	-	5,5	54	11 - 12	6,5	800	200	2,5	<b>DCE6,5/4909LKS</b>	<b>DCE6,5/4919LKS</b>
I-5	•	5	43,5	-	5,5	54	11 - 12	6,5	400	200	3	<b>DCAE6,5/5909LKS</b>	<b>DCAE6,5/5919LKS</b>
I-5	•	5	43,5	-	5,5	54	11 - 12	6,5	400	200	3,5	<b>DCE6,5/5909LKS</b>	<b>DCE6,5/5919LKS</b>
I-10	•	-	40	8,5	5,5	54	11 - 12	M8 x 1	800	200	2	<b>DCAE8/4909KS</b>	<b>DCAE8/4919KS</b>
I-10	•	-	40	8,5	5,5	54	11 - 12	M8 x 1	800	200	2,5	<b>DCE8/4909KS</b>	<b>DCE8/4919KS</b>
I-10	•	5	35	8,5	5,5	54	11 - 12	M8 x 1	400	200	3	<b>DCAE8/5909KS</b>	<b>DCAE8/5919KS</b>
I-10	•	5	35	8,5	5,5	54	11 - 12	M8 x 1	400	200	3,5	<b>DCE8/5909KS</b>	<b>DCE8/5919KS</b>

(\*) Note: See mounting precautions (pag. 22)

### NPN (negative switching)

Use the above mentioned part number changing the last number 9 with 8 (ie. DCAE6,5/4908LKS)

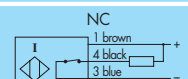
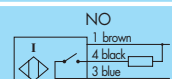

# CYLINDRICAL INDUCTIVE SENSORS IN METAL HOUSING

- Extended sensing distance - diameter 8 - 12 mm
- Amplified in d.c.
- Connector output M12 x 1

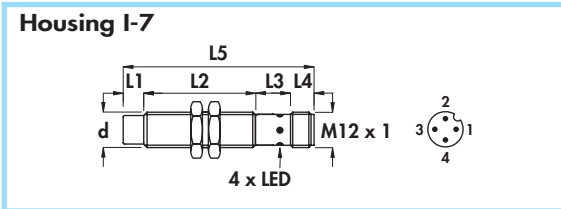
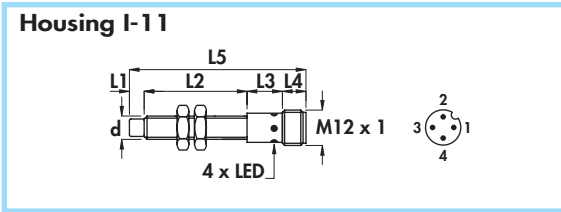

Diameter	M8 x 1	M12 x 1
Nut	Size	SW13
	Thkns mm	4
Max tightening torque Nm	10	15

**Materials:**

- Housing 8 mm: stainless steel
- Housing 12 mm: nickel plated brass
- Sensing face: plastic

**Technical data:**

- Supply voltage ( $U_B$ ): see ordering references
- Max ripple: 10%
- Rated operational current ( $I_o$ ): 200 mA
- No-load supply current ( $I_o$ ):  $\leq 10$  mA
- Voltage drop ( $U_d$ ):  $\leq 1,5$  V
- Temperature range:  $-20^\circ \div +70^\circ\text{C}$
- Max thermal drift of sensing distance  $S_p$ :  $\pm 10\%$
- Repeat accuracy (R): 4%
- Switching hysteresis (H): 10%
- Degree of protection: IP67
- Switch status indicator: yellow LED
- Protected against short-circuit and overload
- Protected against any wrong connection
- Suppression of initial false impulse
- Electromagnetic compatibility (EMC) according to EN60947-5-2
- Shock and vibration resistance according to EN60068-2-27 EN60068-2-6

Housing	Flush mounting (*) Non flush mounting	L1	L2	L3	L4	L5	Female connector	Body diameter (d)	Supply voltage ( $U_B$ )	Max switching frequency (f)	Nominal sensing distance ( $S_n$ ) $\pm 10\%$	ORDERING REFERENCES	
		mm	mm	mm	mm	mm						n°	mm
I-11	•	-	40	12	8	60	6-8B-10	M8 x 1	7 ÷ 30	800	2		
I-11	•	-	40	12	8	60	6-8B-10	M8 x 1	7 ÷ 30	800	2,5	<b>DCAE8/4309KS</b>	<b>DCAE8/43C9KS</b>
I-11	•	5	35	12	8	60	6-8B-10	M8 x 1	7 ÷ 30	400	3	<b>DCE8/4309KS</b>	<b>DCE8/43C9KS</b>
I-11	•	5	35	12	8	60	6-8B-10	M8 x 1	7 ÷ 30	400	3,5	<b>DCAE8/5309KS</b>	<b>DCAE8/53C9KS</b>
I-11	•	5	35	12	8	60	6-8B-10	M8 x 1	7 ÷ 30	400	3,5	<b>DCE8/5309KS</b>	<b>DCE8/53C9KS</b>
I-7	•	-	43	15	8	66	6-8B-10	M12 x 1	7 ÷ 40	800	3	<b>DCAE12/4309KS</b>	<b>DCAE12/43C9KS</b>
I-7	•	-	43	15	8	66	6-8B-10	M12 x 1	7 ÷ 40	800	4	<b>DCE12/4309KS</b>	<b>DCE12/43C9KS</b>
I-7	•	7	36	15	8	66	6-8B-10	M12 x 1	7 ÷ 40	600	5	<b>DCAE12/5309KS</b>	<b>DCAE12/53C9KS</b>
I-7	•	7	36	15	8	66	6-8B-10	M12 x 1	7 ÷ 40	600	6	<b>DCE12/5309KS</b>	<b>DCE12/53C9KS</b>

(\*) Note: See mounting precautions (pag. 22)

**NPN (negative switching)**  
Use the above mentioned part number changing the last number 9 with 8 (ie. DCE8/4308KS)

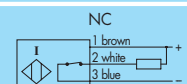
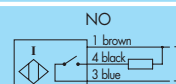

**Extended sensing distance - diameters 18 - 30 mm •**  
**Amplified in d.c. •**  
**Connector output M12 x 1 •**

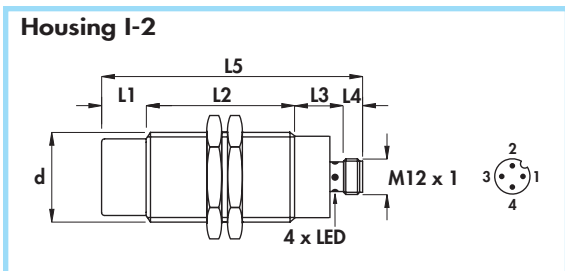
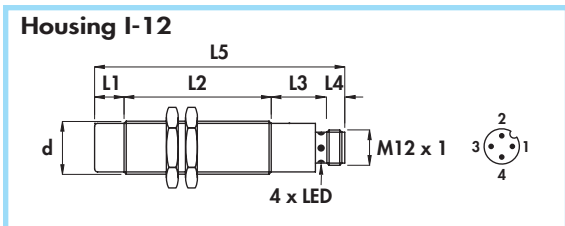

Diameter	M18 x 1	M30 x 1,5
Nut	Size	SW24
	Thkns mm	4
Max tightening torque Nm	35	80

### Materials:

- Housing: nickel plated brass
- Sensing face: plastic

### Technical data:

- Supply voltage ( $U_B$ ): see ordering references
- Max ripple: 10%
- Rated operational current ( $I_B$ ): 200 mA
- No-load supply current ( $I_0$ ):  $\leq 10$  mA
- Voltage drop ( $U_d$ ):  $\leq 1,5$  V
- Temperature range:  $-20^\circ \div +70^\circ\text{C}$
- Max thermal drift of sensing distance  $S_r$ :  $\pm 10\%$
- Repeat accuracy (R): 4%
- Switching hysteresis (H): 10%
- Degree of protection: IP67
- Switch status indicator: yellow LED
- Protected against short-circuit and overload
- Protected against any wrong connection
- Suppression of initial false impulse
- Electromagnetic compatibility (EMC) according to EN60947-5-2
- Shock and vibration resistance according to EN60068-2-27 EN60068-2-6

Housing	Flush mounting (*) Non flush mounting	L1	L2	L3	L4	L5	Female connector	Body diameter (d)	Supply voltage ( $U_B$ )	Max switching frequency (f)	Nominal sensing distance ( $S_n$ ) $\pm 10\%$	ORDERING REFERENCES	
												PNP (positive switching)	
I-12	•	-	50	19	8	77	6-8B-10	M18 x 1	7 ÷ 40	300	10		
I-12	•	-	50	19	8	77	6-8B-10	M18 x 1	7 ÷ 40	300	10		
I-12	•	10	50	19	8	87	6-8B-10	M18 x 1	7 ÷ 40	200	14		
I-12	•	10	50	19	8	87	6-8B-10	M18 x 1	7 ÷ 40	200	14		
I-2	•	-	65	17	8	90	6-8B-10	M30 x 1,5	7 ÷ 40	100	20		
I-2	•	-	65	17	8	90	6-8B-10	M30 x 1,5	7 ÷ 40	100	20		
I-2	•	15	50	17	8	90	6-8B-10	M30 x 1,5	7 ÷ 40	100	28		
I-2	•	15	50	17	8	90	6-8B-10	M30 x 1,5	7 ÷ 40	100	28		

(\*) Note: See mounting precautions (pag. 22)

NPN (negative switching)	
Use the above mentioned part number changing the last number 9 with 8 (ie. DCE8/4308KS)	

# CYLINDRICAL INDUCTIVE SENSORS IN METAL HOUSING

- **SHORT SERIES - Extended sensing distance**
- **Amplified in d.c. 3 wires**
- **Cable output**

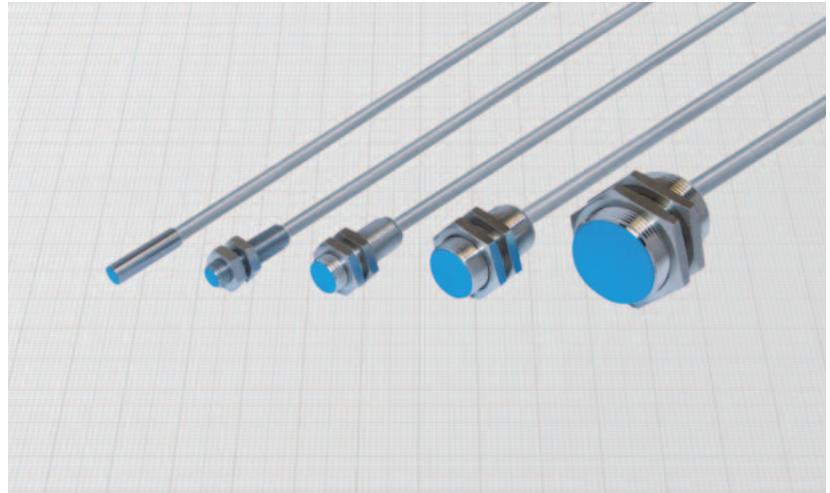
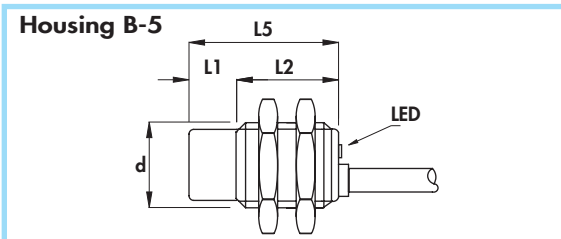
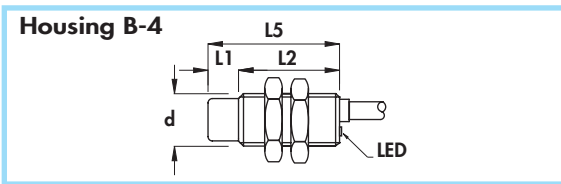
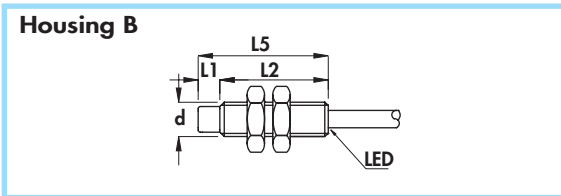
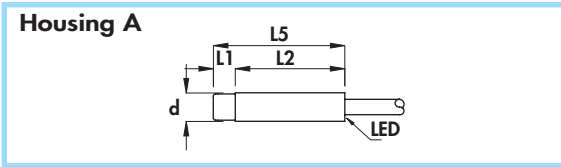

Diameter	M8 x 1	M12 x 1	M18 x 1	M30 x 1,5
Nut	Size	SW13	SW17	SW24
	Thickness mm	4	4	4
Max tightening torque Nm	10	15	35	80

**Materials:**

- Cable: 2 m PVC CEI 20 - 22 II; 90°C; 300 V; O.R.
- Housing 6,5 and 8 mm: stainless steel
- Housing 12 ÷ 30 mm: nickel plated brass
- Sensing face: plastic

**Technical data:**

- Supply voltage ( $U_b$ ): see ordering references
- Max ripple: 10%
- No-load supply current ( $I_0$ ):  $\leq 10$  mA
- Voltage drop ( $U_d$ ):  $\leq 1,5$  V
- Temperature range:  $-20^\circ \div +70^\circ$  C
- Max thermal drift of sensing distance  $S_T$ :  $\pm 10\%$
- Repeat accuracy (R): 4%
- Switching hysteresis (H): 10%
- Degree of protection: IP67
- Switch status indicator: yellow LED
- Cable conductor cross section: 0,22 mm<sup>2</sup> on 6,5 and 8 mm  
0,35 mm<sup>2</sup> on 12 mm  
0,50 mm<sup>2</sup> on 18 and 30 mm

- Protected against short-circuit and overload
- Protected against any wrong connection
- Suppression of initial false impulse
- Electromagnetic compatibility (EMC) according to EN60947-5-2
- Shock and vibration resistance according to EN60068-2-27 EN60068-2-6

Housing	Flush mounting (*) Non flush mounting	L1	L2	L3	L4	L5	Cable diameter	Body diameter (d)	Supply voltage ( $U_b$ )	Max switching frequency (f)	Rated operational current ( $I_e$ )	Nominal sensing distance ( $S_n$ ) $\pm 10\%$	ORDERING REFERENCES	
		mm	mm	mm	mm	PNP (positive switching)								
		NO brown black blue		NC brown black blue										
A	•	-	30	-	-	30	3,5	6,5	7 ÷ 30	800	200	2,5	<b>DSE6,5/4609LKS</b>	<b>DSE6,5/4619LKS</b>
B	•	-	30	-	-	30	3,5	M8 x 1	7 ÷ 30	800	200	2,5	<b>DSE8/4609KS</b>	<b>DSE8/4619KS</b>
B-4	•	-	30	-	-	30	4	M12 x 1	7 ÷ 30	800	200	4	<b>DSE12/4609KS</b>	<b>DSE12/4619KS</b>
B-4	•	7	23	-	-	30	4	M12 x 1	7 ÷ 30	600	200	6	<b>DSE12/5609KS</b>	<b>DSE12/5619KS</b>
B-5	•	-	35	-	-	35	5	M18 x 1	7 ÷ 40	300	200	10	<b>DSE18/4609KS</b>	<b>DSE18/4619KS</b>
B-5	•	10	25	-	-	35	5	M18 x 1	7 ÷ 40	200	200	14	<b>DSE18/5609KS</b>	<b>DSE18/5619KS</b>
B-5	•	-	35	-	-	35	6	M30 x 1,5	7 ÷ 40	100	200	20	<b>DSE30/4609KS</b>	<b>DSE30/4619KS</b>
B-5	•	15	20	-	-	35	6	M30 x 1,5	7 ÷ 40	100	200	28	<b>DSE30/5609KS</b>	<b>DSE30/5619KS</b>

(\*) Note: See mounting precautions (pag. 22)

**NPN (negative switching)**  
Use the above mentioned part number changing the last number 9 with 8 (ie. DSE6,5/4608LKS)

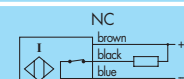
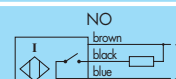



**SHORT SERIES - Extended sensing distance •  
Amplified in d.c. •  
Connector output M8 x 1 •**

**Housing I-8**

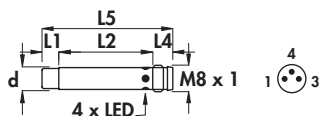

**Housing I-6**

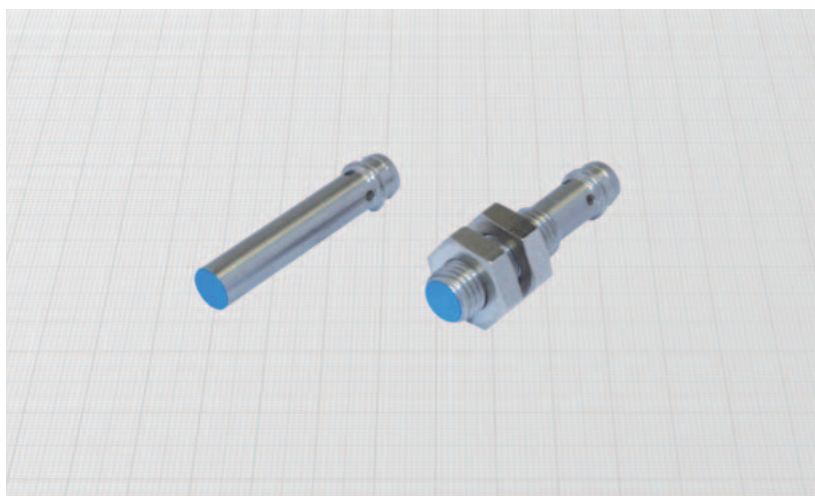
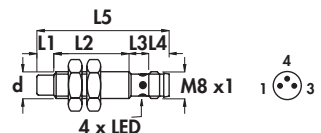

Diameter	M8 x 1	
Nut	Size	SW13
	Thickness mm	4
Max tightening torque Nm	10	

**Materials:**

- Housing: stainless steel
- Sensing face: plastic

**Technical data:**

- Supply voltage ( $U_B$ ):  $7 \div 30$  Vdc
- Max ripple: 10%
- No-load supply current ( $I_0$ ):  $\leq 10$  mA
- Voltage drop ( $U_d$ ):  $\leq 1,5$  V
- Temperature range:  $-20^\circ \div +70^\circ$  C
- Max thermal drift of sensing distance  $S_r$ :  $\pm 10\%$
- Repeat accuracy (R): 4%
- Switching hysteresis (H): 10%
- Degree of protection: IP67
- Switch status indicator: yellow LED
- Protected against short-circuit and overload
- Protected against any wrong connection
- Suppression of initial false impulse
- Electromagnetic compatibility (EMC) according to EN60947-5-2
- Shock and vibration resistance according to EN60068-2-27 EN60068-2-6

Housing	Flush mounting (*) Non flush mounting	L1	L2	L3	L4	L5	Female connector	Body diameter (d)	Max switching frequency (f)	Rated operational current (I <sub>e</sub> )	Nominal sensing distance (S <sub>n</sub> ) ±10%	ORDERING REFERENCES	
												PNP (positive switching)	
I-8	•	-	29,5	-	5,5	35	11 - 12	6,5	800	200	2,5	NO 1 brown 4 black 3 blue	NC 1 brown 4 black 3 blue
I-6	•	-	21	8,5	5,5	35	11 - 12	M8 x 1	800	200	2,5	<b>DSE6,5/4909LKS</b>	<b>DSE6,5/4919LKS</b>
												<b>DSE8/4909KS</b>	<b>DSE8/4919KS</b>

(\*) Note: See mounting precautions (pag. 22)

NPN (negative switching)	
Use the above mentioned part number changing the last number 9 with 8 (ie. DSE6,5/4908LKS)	
NO 1 brown 4 black 3 blue	NC 1 brown 4 black 3 blue

# CYLINDRICAL INDUCTIVE SENSORS IN METAL HOUSING

- **SHORT SERIES** - Extended sensing distance
- **Amplified in d.c.**
- Connector output M12 x 1

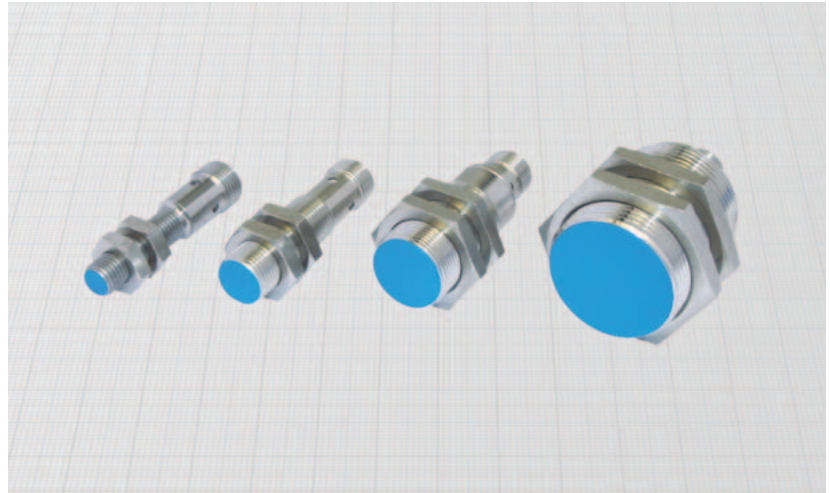
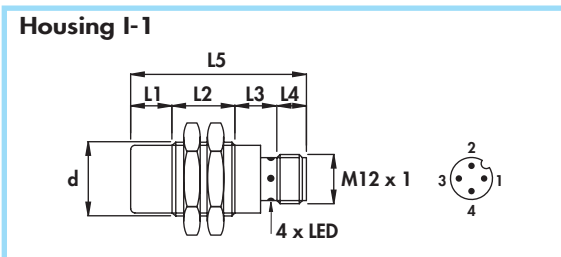
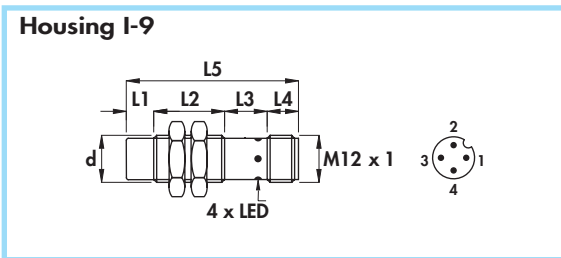
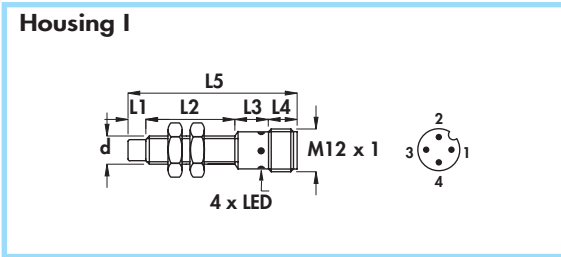

Diameter	M8 x 1	M12 x 1	M18 x 1	M30 x 1,5
Nut	Size	SW13	SW17	SW24
	Thickness mm	4	4	4
Max tightening torque Nm	10	15	35	80

**Materials:**

- Housing 8 mm: stainless steel
- Housing 12 ÷ 30 mm: nickel plated brass
- Sensing face: plastic

**Technical data:**

- Supply voltage ( $U_B$ ): see ordering references
- Max ripple: 10%
- Rated operational current ( $I_o$ ): 200 mA
- No-load supply current ( $I_o$ ):  $\leq 10$  mA
- Voltage drop ( $U_d$ ):  $\leq 1,5$  V
- Temperature range:  $-20^\circ \div +70^\circ\text{C}$
- Max thermal drift of sensing distance  $S_T$ :  $\pm 10\%$
- Repeat accuracy (R): 4%
- Switching hysteresis (H): 10%
- Degree of protection: IP67
- Switch status indicator: yellow LED
- Protected against short-circuit and overload
- Protected against any wrong connection
- Suppression of initial false impulse
- Electromagnetic compatibility (EMC) according to EN60947-5-2
- Shock and vibration resistance according to EN60068-2-27 EN60068-2-6

Housing	Flush mounting (*) Non flush mounting	L1	L2	L3	L4	L5	Female connector	Body diameter (d)	Supply voltage ( $U_B$ )	Max switching frequency (f)	Nominal sensing distance ( $S_n$ ) $\pm 10\%$	ORDERING REFERENCES	
												PNP (positive switching)	
												NO	NC
I	•	-	26	13	8	47	6-8B-10	M8 x 1	7 ÷ 30	800	2,5		
I-9	•	-	30	10	8	48	6-8B-10	M12 x 1	7 ÷ 30	800	4	<b>DSE8/4309KS</b>	<b>DSE8/43C9KS</b>
I-9	•	7	23	10	8	48	6-8B-10	M12 x 1	7 ÷ 30	600	6	<b>DSE12/4309KS</b> <b>DSE12/5309KS</b>	<b>DSE12/43C9KS</b> <b>DSE12/53C9KS</b>
I-1	•	-	30	19	8	57	6-8B-10	M18 x 1	7 ÷ 40	300	10	<b>DSE18/4309KS</b> <b>DSE18/5309KS</b>	<b>DSE18/43C9KS</b> <b>DSE18/53C9KS</b>
I-1	•	10	25	15	8	58	6-8B-10	M18 x 1	7 ÷ 40	200	14	<b>DSE30/4309KS</b> <b>DSE30/5309KS</b>	<b>DSE30/43C9KS</b> <b>DSE30/53C9KS</b>
I-1	•	-	25	17	8	50	6-8B-10	M30 x 1,5	7 ÷ 40	100	20	<b>DSE30/4309KS</b> <b>DSE30/5309KS</b>	<b>DSE30/43C9KS</b> <b>DSE30/53C9KS</b>
I-1	•	15	25	17	8	65	6-8B-10	M30 x 1,5	7 ÷ 40	100	28		

(\*) Note: See mounting precautions (pag. 22)

**NPN (negative switching)**  
Use the above mentioned part number changing the last number 9 with 8 (ie. DSE8/4308KS)



# CYLINDRICAL INDUCTIVE SENSORS IN METAL HOUSING

- With extended temperature range (- 40° ÷ + 85°C) •
- Amplified in d.c. 3 and 4 wires •
- Cable output •

**Housing A-3**

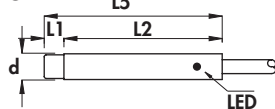

**Housing B-6**

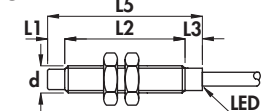

**Housing B-3**

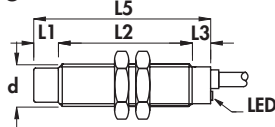

**Housing G**

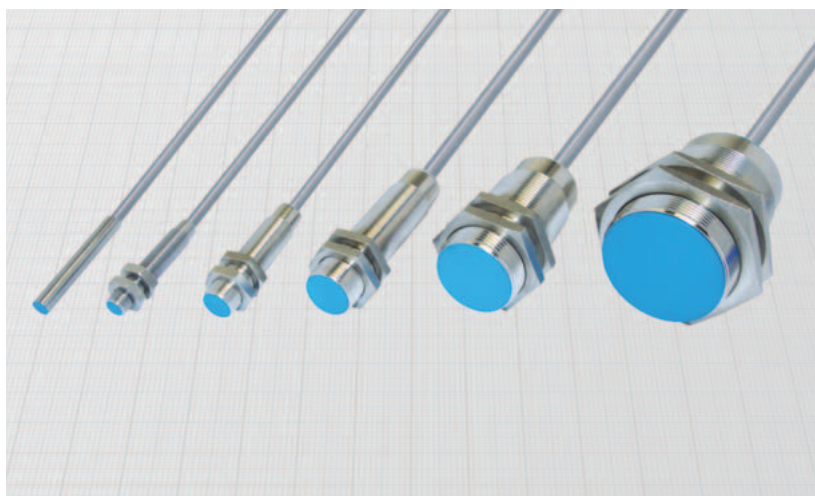
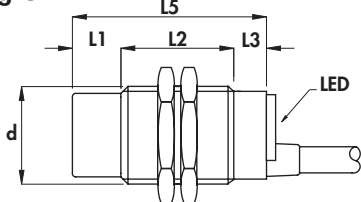

Diameter		M8 x 1	M12 x 1	M18 x 1	M30 x 1,5	M45 x 1,5
Nut	Size	SW13	SW17	SW24	SW36	SW55
	Thkns mm	4	4	4	5	5
Max tightening torque Nm		10	15	35	80	70

**Materials:**

- Cable: 2 m thermoplastic 140°C; 300 V; O.R.
- Housing 6,5 and 8 mm: stainless steel
- Housing 12 ÷ 45 mm: nickel plated brass
- Sensing face: plastic

**Technical data:**

- Supply voltage (U<sub>B</sub>): 10 ÷ 30 Vdc
- Max ripple: 10%
- No-load supply current (I<sub>0</sub>): ≤ 10 mA
- Voltage drop (U<sub>d</sub>): see ordering references
- Temperature range: - 40° ÷ + 85°C
- Max thermal drift of sensing distance S<sub>r</sub>: ± 10%
- Repeat accuracy (R): 2%
- Switching hysteresis (H): 10%
- Degree of protection: IP67
- Switch status indicator: yellow LED
- Cable conductor cross section: 0,35 mm<sup>2</sup> on 6,5 - 8 - 12 mm  
0,50 mm<sup>2</sup> on 18, 30 and 45 mm
- Protected against short-circuit and overload
- Protected against any wrong connection
- Suppression of initial false impulse
- Electromagnetic compatibility (EMC) according to EN60947-5-2
- Shock and vibration resistance according to EN60068-2-27 EN60068-2-6

Housing	Flugh mounting Non flush mounting	L2	L3	L5	Cable diameter	Body diameter (d)	Voltage drop (U <sub>d</sub> )	Max switching frequency (f)	Rated operational current (I <sub>e</sub> )	Nominal sensing distance (S <sub>n</sub> ) ± 10%	ORDERING REFERENCES			
											PNP (positive switching)			
		mm	mm	mm	mm	mm	V	KHz	mA	mm	NO	NC	NO + NC	
A-3	•	45	-	45	4	6,5	1,5	4	150	1,5				
B-6	•	40	5	45	4	M8 x 1	1,5	4	150	1,5				
B-3	•	43	7	50	4	M12 x 1	1,5	2	150	2				
B-3	•	58	12	70	5	M18 x 1	2,2	1	250	5				
G	•	50	10	60	6	M30 x 1,5	2,2	0,8	250	10				
G	•	50	10	60	6	M45 x 1,5	2,2	0,15	250	20				
												NPN (negative switching)		
												Use the above mentioned part number changing the last number 9 with 8 (ie. DCA6,5/4608LKST)		
		mm	mm	mm	mm	mm	V	KHz	mA	mm	NO	NC	NO + NC	

# CYLINDRICAL INDUCTIVE SENSORS IN METAL HOUSING

- With extended temperature range (-40° ÷ + 85°C)
- Amplified in d.c. 3 and 4 wires
- Connector output M12 x 1

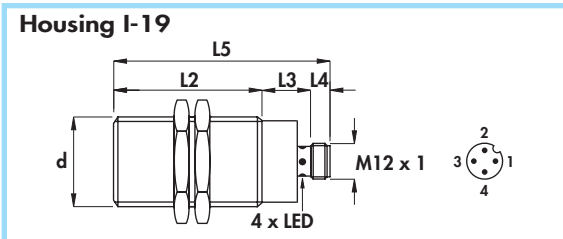
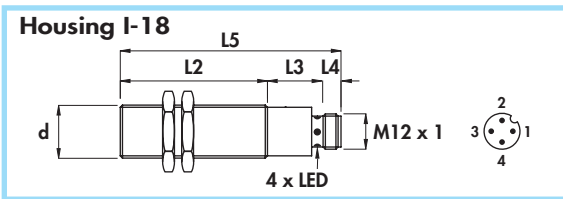
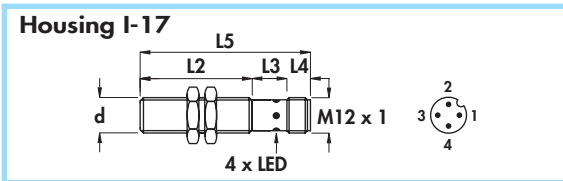
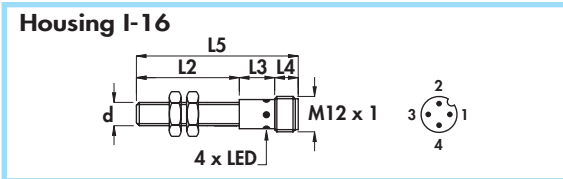

Diameter	M8 x 1	M12 x 1	M18 x 1	M30 x 1,5	M45 x 1,5	
Nut	Size	SW13	SW17	SW24	SW36	SW55
	Thkns mm	4	4	4	5	5
Max tightening torque Nm	10	15	35	80	70	

**Materials:**

- Housing 8 mm: stainless steel
- Housing 12 ÷ 45 mm: nickel plated brass
- Sensing face: plastic

**Technical data:**

- Supply voltage (U<sub>B</sub>): 10 ÷ 30 Vdc
- Max ripple: 10%
- No-load supply current (I<sub>0</sub>): ≤ 10 mA
- Voltage drop (U<sub>d</sub>): see ordering references
- Temperature range: -40° ÷ + 85°C
- Max thermal drift of sensing distance S<sub>r</sub>: ± 10%
- Repeat accuracy (R): 2%
- Switching hysteresis (H): 10%
- Degree of protection: IP67
- Switch status indicator: yellow LED
- Protected against short-circuit and overload
- Protected against any wrong connection
- Suppression of initial false impulse
- Electromagnetic compatibility (EMC) according to EN60947-5-2
- Shock and vibration resistance according to EN60068-2-27 EN60068-2-6

Housing	Flush mounting Non flush mounting	L2	L3	L4	L5	Female connector (see pag. H-1)	Body diameter (d)	Voltage drop (U <sub>d</sub> )	Max switching frequency (f <sub>y</sub> )	Rated operational current (I <sub>o</sub> )	Nominal sensing dist. (S <sub>r</sub> ) ± 10%	ORDERING REFERENCES			
												PNP (positive switching)			
												NO	NC	NO + NC	
I-16	•	40	12	8	60	8B-10...T	M8 x 1	1,5	4	150	1,5				-
I-17	•	43	15	8	66	8B-10...T	M12 x 1	1,5	2	150	2				DCA12/4329KST
I-18	•	50	19	8	77	8B-10...T	M18 x 1	2,2	1	250	5				DCA18/4329KST
I-19	•	65	17	8	90	8B-10...T	M30 x 1,5	2,2	0,8	250	10				DCA30/4329KST
I-19	•	50	19	8	77	8B-10...T	M45 x 1,5	2,2	0,15	250	20				DCA45/4329KST

**NPN (negative switching)**

Use the above mentioned part number changing the last number 9 with 8 (ie. DCA8/4308KST)

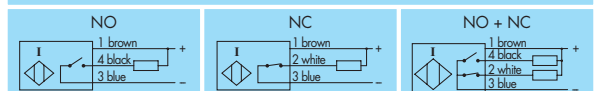



For high temperatures (-25° ÷ +125°C) •  
 Amplified in d.c. 3 and 4 wires •  
 Cable output •

**Housing A-3**

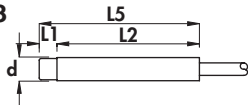

**Housing B-6**

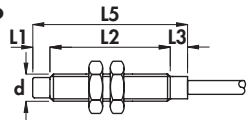

**Housing B-3**

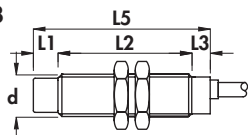

**Housing B-7**

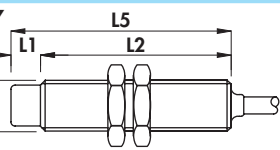

**Housing G**

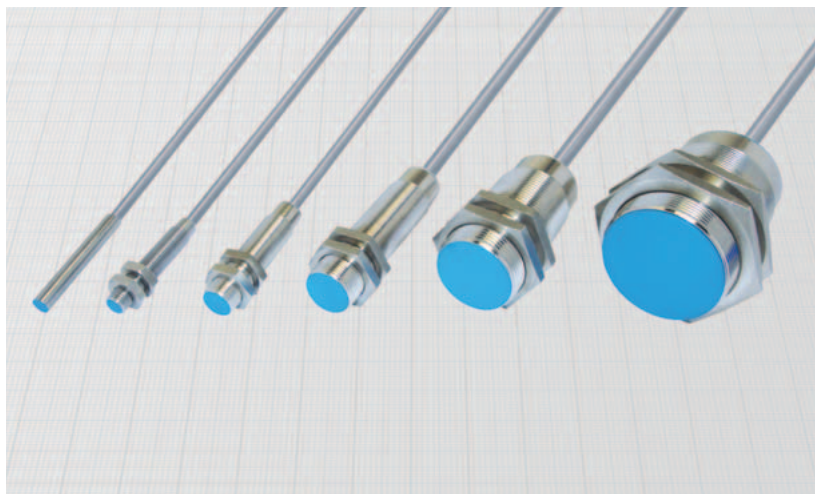
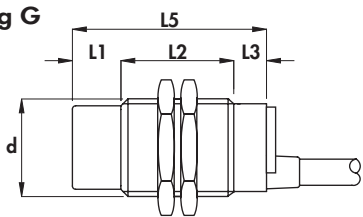

Diameter		M8 x 1	M12 x 1	M18 x 1	M30 x 1,5	M45 x 1,5
Nut	Size	SW13	SW17	SW24	SW36	SW55
	Thickness mm	4	4	4	5	5
Max tightening torque Nm		10	15	35	80	70

**Materials:**

- Cable: 2 m thermoplastic 140°C; 300 V; O.R.
- Housing 6,5 and 8 mm: stainless steel
- Housing 12 ÷ 45 mm: nickel plated brass
- Sensing face: plastic

**Technical data:**

- Supply voltage (U<sub>B</sub>): 10 ÷ 30 Vdc
- Max ripple: 10%
- No-load supply current (I<sub>0</sub>): ≤ 10 mA
- Voltage drop (U<sub>d</sub>): see ordering references
- Temperature range: -25° ÷ +125°C
- Max thermal drift of sensing distance S<sub>r</sub>: ± 10%
- Repeat accuracy (R): 2%
- Switching hysteresis (H): 10%
- Degree of protection: IP67
- Cable conductor cross section: 0,35 mm<sup>2</sup> on 6,5 - 8 - 12 mm  
0,50 mm<sup>2</sup> on 18 - 30 - 45 mm

- Protected against short-circuit and overload
- Protected against any wrong connection
- Suppression of initial false impulse
- Electromagnetic compatibility (EMC) according to EN60947-5-2
- Shock and vibration resistance according to EN60068-2-27 EN60068-2-6



Housing	Flush mounting Non flush mounting	L2	L3	L5	Cable diameter	Body diameter (d)	Voltage drop (U <sub>d</sub> )	Max switching frequency (f)	Rated operational current (I <sub>0</sub> )	Nominal sensing distance (S <sub>n</sub> ) ± 10%	ORDERING REFERENCES		
											PNP (positive switching)		
		mm	mm	mm	mm	mm	V	KHz	mA	mm	NO	NC	NO + NC
A-3	•	45	-	45	4	6,5	1,5	4	150	1,5			-
B-6	•	40	5	45	4	M8 x 1	1,5	4	150	1,5			-
B-3	•	43	7	50	4	M12 x 1	1,5	2	150	2			-
B-7	•	65	-	65	5	M18 x 1	2,2	1	250	5			DCA18/4629KT
G	•	50	10	60	6	M30 x 1,5	2,2	0,8	250	10			DCA30/4629KT
G	•	50	10	60	6	M45 x 1,5	2,2	0,15	250	20			DCA45/4629KT

**NPN (negative switching)**

Use the above mentioned part number changing the last number 9 with 8 (ie. DCA6,5/4608LKT)

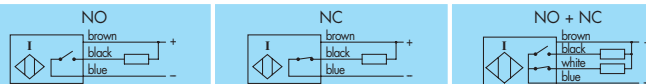

# CYLINDRICAL INDUCTIVE SENSORS IN METAL HOUSING

- For high temperatures (-25° ÷ + 120°C)
- Amplified in d.c. 3 and 4 wires
- Connector output M12 x 1

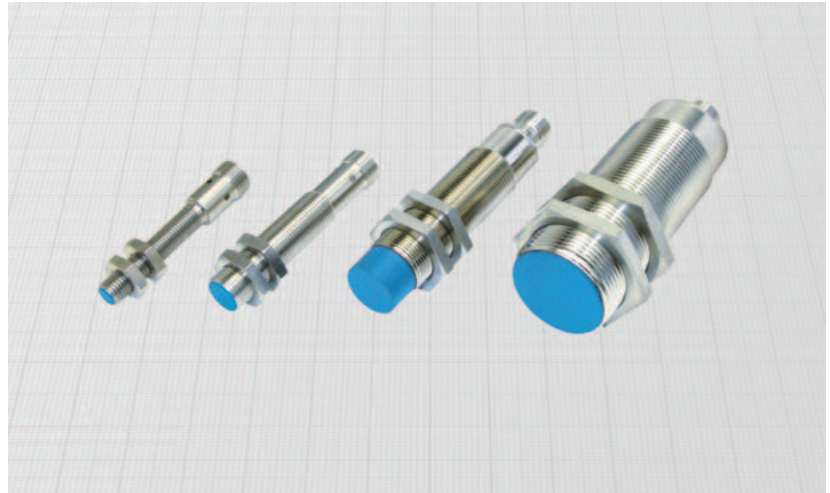
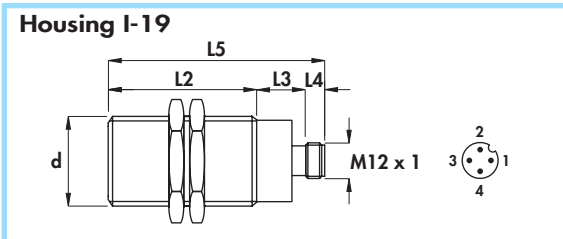
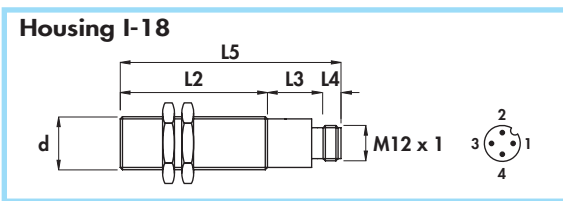
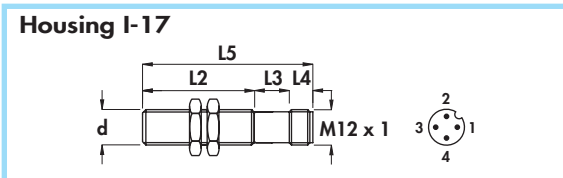
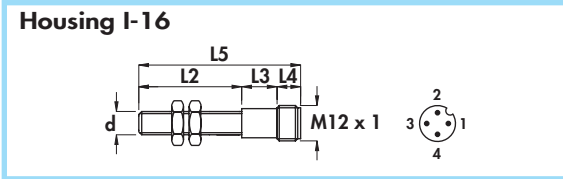

Diameter		M8 x 1	M12 x 1	M18 x 1	M30 x 1,5
Nut	Size	SW13	SW17	SW24	SW36
	Thickness mm	4	4	4	5
Max tightening torque Nm		10	15	35	80

### Materials:

- Housing 8 mm: stainless steel
- Housing 12 ÷ 30 mm: nickel plated brass
- Sensing face: plastic

### Technical data:

- Supply voltage ( $U_b$ ): 10 ÷ 30 Vdc
- Max ripple: 10%
- No-load supply current ( $I_o$ ): ≤ 10 mA
- Voltage drop ( $U_d$ ): see ordering references
- Temperature range: -25° ÷ +120° C
- Max thermal drift of sensing distance  $S_T$ : ± 10%
- Repeat accuracy (R): 2%
- Switching hysteresis (H): 10%
- Degree of protection: IP67
- Protected against short-circuit and overload
- Protected against any wrong connection
- Suppression of initial false impulse
- Electromagnetic compatibility (EMC) according to EN60947-5-2
- Shock and vibration resistance according to EN60068-2-27 EN60068-2-6

Housing	Flush mounting Non flush mounting	L2	L3	L4	L5	Female connector (see pag. H - 1)	Body diameter (d)	Voltage drop ( $U_d$ )	Max switching frequency (f)	Rated operational current ( $I_o$ )	Nominal sensing dist. ( $S_T$ ) ± 10%	ORDERING REFERENCES		
												PNP (positive switching)		
		mm	mm	mm	mm	n°	mm	V	KHz	mA	mm	NO	NC	NO + NC
I-11	•	40	12	8	60	8B-10...T	M8 x 1	1,5	4	150	1,5			-
I-7	•	43	15	8	66	8B-10...T	M12 x 1	1,5	2	150	2			DCA12/4329KT
I-12	•	50	19	8	77	8B-10...T	M18 x 1	2,2	1	250	5			DCA18/4329KT
I-2	•	65	17	8	90	8B-10...T	M30 x 1,5	2,2	0,8	250	10			DCA30/4329KT
I-2	•	50	19	8	77	8B-10...T	M45 x 1,5	2,2	0,15	250	20			DCA45/4329KT

### NPN (negative switching)

Use the above mentioned part number changing the last number 9 with 8 (ie. DCA8/4308KT)

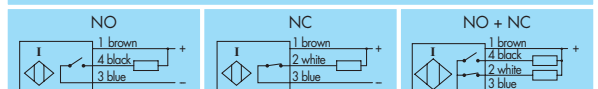

- Degree of protection IP68 •
- Amplified in d.c. 3 and 4 wires •
- Cable and connector output M12 x 1 •

## Housing J-1

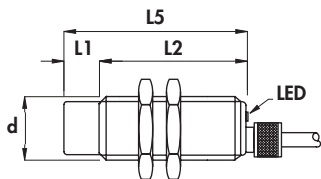

## Housing J-2

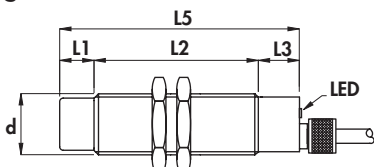

## Housing I-12

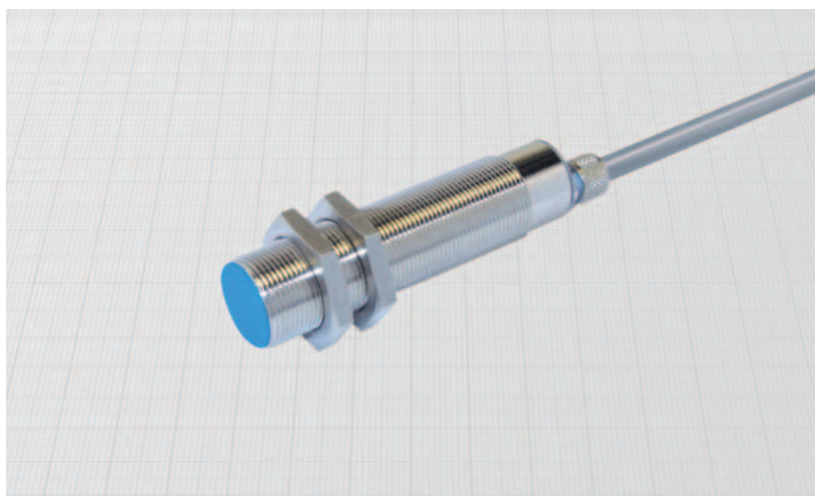
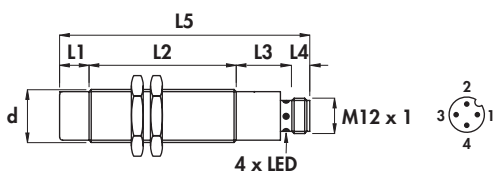

### General Features:

This new series solves definitively the problem of the ingress of liquids to the inner parts of the sensors. Thanks to the inner hermetic sealing they can be submitted to no-stop jets of liquids under pressure even in presence of temperature changes. They find application in automatic washing machinery, in machines subject to water jets and in continuous immersion applications.

### Technical data:

- Supply voltage ( $U_b$ ): 7 ÷ 60 Vdc
- Max ripple: 10%
- Rated operational current ( $I_o$ ): 400 mA
- No-load supply current ( $I_o$ ): ≤ 10 mA
- Voltage drop ( $U_d$ ): ≤ 2,2 V
- Temperature range: -25° ÷ +75°C
- Max thermal drift of sensing distance  $S_r$ : ± 10%
- Repeat accuracy (R): 2%
- Switching hysteresis (H): 10%
- Degree of protection: IP68
- Switch status indicator: yellow LED
- Cable conductor cross section: 0,50 mm<sup>2</sup>
- Protected against short-circuit and overload
- Protected against any wrong connection
- Suppression of initial false impulse
- Electromagnetic compatibility (EMC) according to EN60947-5-2
- Shock and vibration resistance according to EN60068-2-27 EN60068-2-6

Diameter	M18 x 1	
Nut	Size	SW24
	Thickness mm	4
Max tightening torque Nm	35	

### Materials:

- Cable: 2 m PVC CEI 20 - 22 II; 90°C; 300 V; O.R.
- Housing and gland: nickel plated brass
- Sensing face: plastic

Housing	Mounting	L1	L2	L3	L4	L5	Cable diameter	Female connector	Body diameter (d)	Max switching frequency (f)	Nominal sensing distance ( $S_n$ ) ± 10%	ORDERING REFERENCES		
												PNP (positive switching)		
												NO	NC	NO + NC
J-1	•	-	50	-	-	50	5	-	M18 x 1	1	5	DCA18/4A09KSJ	DCA18/4A19KSJ	-
J-1	•	10	40	-	-	50	5	-	M18 x 1	1	8	DCA18/5A09KSJ	DCA18/5A19KSJ	-
J-2	•	-	58	12	-	70	5	-	M18 x 1	1	5	DCA18/4609KSJ	DCA18/4619KSJ	DCA18/4629KSJ
J-2	•	10	48	12	-	70	5	-	M18 x 1	1	8	DCA18/5609KSJ	DCA18/5619KSJ	DCA18/5629KSJ
I-12	•	-	50	19	8	77	-	6-8B-10	M18 x 1	1	5	DCA18/4309KSJ	DCA18/43C9KSJ	DCA18/4329KSJ
I-12	•	10	50	19	8	87	-	6-8B-10	M18 x 1	1	8	DCA18/5309KSJ	DCA18/53C9KSJ	DCA18/5329KSJ

NPN (negative switching)		
NO	NC	NO + NC
(*) Note: In versions with connector use the white wire.		

# CYLINDRICAL INDUCTIVE SENSORS IN METAL HOUSING

- **SHORT SERIES - degree of protection IP68**
- **Amplified in d.c. 3 wires**
- Cable and connector output M12 x 1

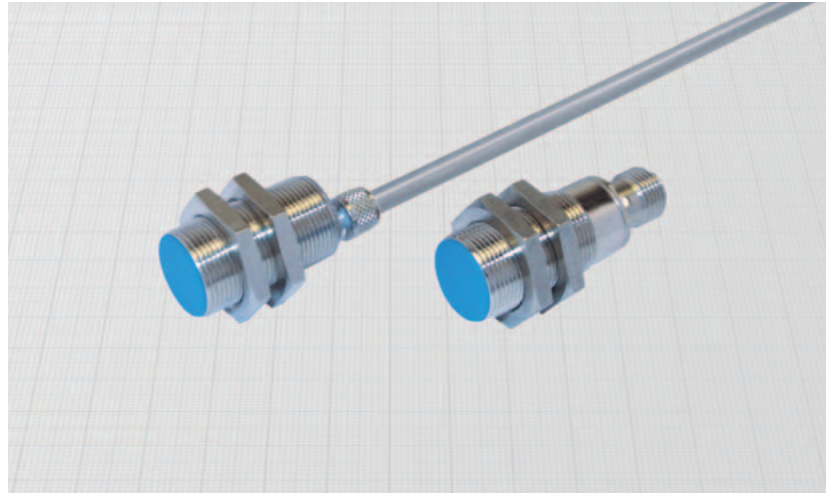
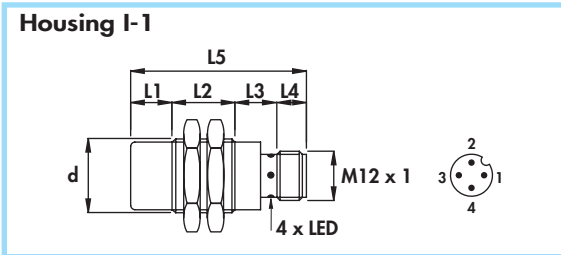
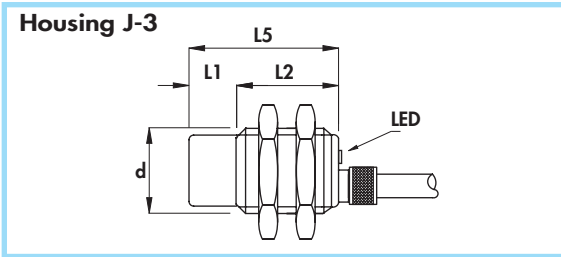

Diameter	M18 x 1	
Nut	Size	SW24
	Thickness mm	4
Max tightening torque Nm	35	

### Materials:

- Cable: 2 m PVC CEI 20 - 22 II; 90°C; 300 V; O.R.
- Housing and gland: nickel plated brass
- Sensing face: plastic

### General Features:

This new series solves definitively the problem of the ingress of liquids to the inner parts of the sensors. Thanks to the inner hermetic sealing they can be submitted to no-stop jets of liquids under pressure even in presence of temperature changes. They find application in automatic washing machinery, in machines subject to water jets and in continuous immersion applications.

### Technical data:

- Supply voltage ( $U_b$ ): 5 ÷ 40 Vdc
- Max ripple: 10%
- No-load supply current ( $I_o$ ): ≤ 10 mA
- Voltage drop ( $U_d$ ): ≤ 1,5 V
- Temperature range: -25° ÷ +70°C
- Max thermal drift of sensing distance  $S_T$ : ± 10%
- Repeat accuracy (R): 2%
- Switching hysteresis (H): 10%
- Degree of protection: IP68
- Switch status indicator: yellow LED
- Cable conductor cross section: 0,50 mm<sup>2</sup>
- Protected against short-circuit and overload
- Protected against any wrong connection
- Suppression of initial false impulse
- Electromagnetic compatibility (EMC) according to EN60947-5-2
- Shock and vibration resistance according to EN60068-2-27 EN60068-2-6

www.bdc-electronic.com

Housing	Flush mounting Non flush mounting	L1	L2	L3	L4	L5	Cable diameter	Female connector	Body diameter (d)	Max switching frequency (f)	Rated operational current (I <sub>e</sub> )	Nominal sensing distance (S <sub>n</sub> ) ± 10%	ORDERING REFERENCES	
													PNP (positive switching)	
J-3	•	-	30	-	-	30	5	-	M18 x 1	0,8	200	5		
J-3	•	10	20	-	-	30	5	-	M18 x 1	0,6	200	8	<b>DSA18/4609KSJ</b> <b>DSA18/5609KSJ</b>	<b>DSA18/4619KSJ</b> <b>DSA18/5619KSJ</b>
I-1	•	-	25	15	8	48	-	6-8B-10	M18 x 1	0,8	200	5		
I-1	•	10	15	15	8	48	-	6-8B-10	M18 x 1	0,6	200	8		
													NPN (negative switching)	
													Use the above mentioned part number changing the last number 9 with 8 (ie. DSA18/4608KSJ)	



- Non polarized
- Amplified in d.c. 2 wires
- Cable output

**Housing B-6**

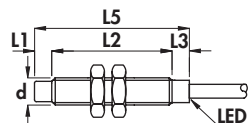

**Housing B-3**

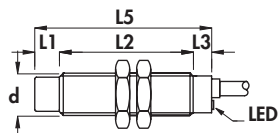

**Housing B-2**

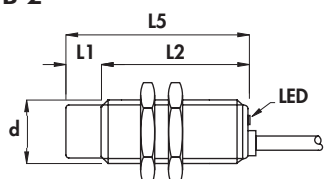

**Housing G**

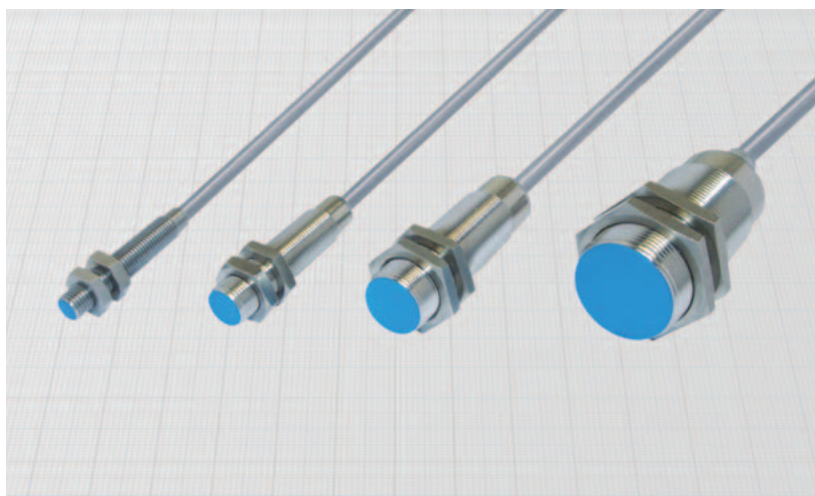
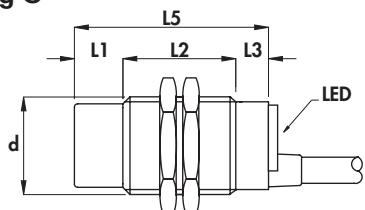

Diameter		M8 x 1	M12 x 1	M18 x 1	M30 x 1,5
Nut	Size	SW13	SW17	SW24	SW36
	Thickness mm	4	4	4	5
Max tightening torque Nm		10	15	35	80

**Materials:**

- Cable: 2 m PVC CEI 20 - 22 II; 90°C; 300 V; O.R.
- Housing 8 mm: stainless steel
- Housing 12-18-30 mm: nickel plated brass
- Sensing face: plastic PBT

**General Features:**

These sensors are not polarized and the load can be connected on both positive and negative lead (function PNP or NPN). So they can replace traditional mechanical microswitches in many applications.

**Technical data:**

- Supply voltage ( $U_B$ ): 10 ÷ 55 Vdc
- Max ripple: 10%
- Off-state current ( $I_o$ ): ≤ 1 mA
- Minimum operational current ( $I_m$ ): 5 mA
- Voltage drop ( $U_d$ ) with  $I_e = 10$  mA: ≤ 5 V
- Voltage drop ( $U_d$ ) with  $I_e = 100$  mA: ≤ 6 V
- Temperature range: -25° ÷ +70°C
- Max thermal drift of sensing distance  $S_s$ : ± 10%
- Repeat accuracy (R): 2%
- Switching hysteresis (H): 10%
- Degree of protection: IP67
- Switch status indicator: yellow LED
- Cable conductor cross section: 0,34 mm<sup>2</sup> on 8 and 12 mm  
0,50 mm<sup>2</sup> on 18 mm  
0,75 mm<sup>2</sup> on 30 mm
- Protected against short-circuit and overload (versions with letter K)
- Suppression of initial false impulse
- Electromagnetic compatibility (EMC) according to EN60947-5-2
- Shock and vibration resistance according to EN60068-2-27 EN60068-2-6

Housing	Flush mounting Non flush mounting	L1	L2	L3	L4	L5	Cable diameter	Body diameter (d)	Nominal sensing distance ( $S_n$ ) ± 10%	Max switching frequency (f)	Rated operational current ( $I_e$ )	ORDERING REFERENCES	
		mm	mm	mm	mm	mm						mm	mm
B-6	•	-	40	5	-	45	4	M8 x 1	1,5	1200	100	DCM8/4600S	DCM8/4610S
B-6	•	5	35	5	-	45	4	M8 x 1	2,5	1000	100	DCM8/5600S	DCM8/5610S
B-3	•	-	43	7	-	50	4	M12 x 1	2	1200	200	DCM12/4600KS	DCM12/4610KS
B-3	•	7	36	7	-	50	4	M12 x 1	4	1000	200	DCM12/5600KS	DCM12/5610KS
B-2	•	-	50	-	-	50	5	M18 x 1	5	1100	250	DCM18/4A00KS	DCM18/4A10KS
B-2	•	10	40	-	-	50	5	M18 x 1	8	700	250	DCM18/5A00KS	DCM18/5A10KS
G	•	-	50	10	-	60	6	M30 x 1,5	10	800	250	DCM30/4600KS	DCM30/4610KS
G	•	15	35	10	-	60	6	M30 x 1,5	15	400	250	DCM30/5600KS	DCM30/5610KS

# CYLINDRICAL INDUCTIVE SENSORS IN METAL HOUSING

- Non polarized
- Amplified in d.c. 2 wires
- Connector output

## Housing I-11

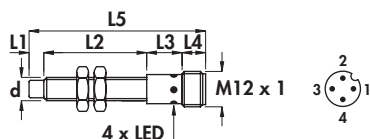

## Housing I-7

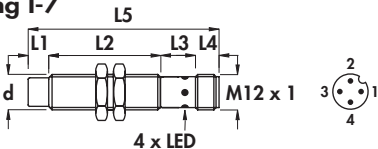

## Housing I-12

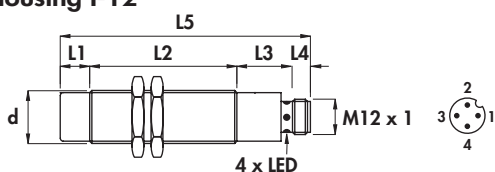

## Housing I-2

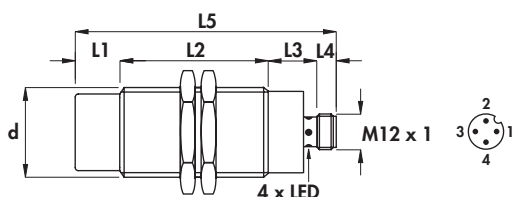

Diameter	M8 x 1	M12 x 1	M18 x 1	M30 x 1,5
Nut Size	SW13	SW17	SW24	SW36
Nut Thickness mm	4	4	4	5
Max tightening torque Nm	10	15	35	80

## Materials:

- Housing 8 mm: stainless steel
- Housing 12- 18 - 30 mm: nickel plated brass
- Sensing face: plastic PBT

www.bdc-electronic.com

## General Features:

These sensors are not polarized and the load can be connected on both positive and negative sectors (function PNP or NPN). So they can replace traditional mechanical microswitches in many applications. Utilization of connectors without LED is recommended.

## Technical data:

- Supply voltage ( $U_b$ ): 10 ÷ 55 Vdc
- Max ripple: 10%
- Off-state current ( $I_o$ ): ≤ 1 mA
- Minimum operational current ( $I_m$ ): 5 mA
- Voltage drop ( $U_d$ ) with  $I_e = 10$  mA: ≤ 5 V
- Voltage drop ( $U_d$ ) with  $I_e = 100$  mA: ≤ 6 V
- Temperature range: -25° ÷ +70°C
- Max thermal drift of sensing distance  $S_r$ : ± 10%
- Repeat accuracy (R): 2%
- Switching hysteresis (H): 10%
- Degree of protection: IP67
- Switch status indicator: yellow LED
- Protected against short-circuit and overload (versions with letter K)
- Suppression of initial false impulse
- Electromagnetic compatibility (EMC) according to EN60947-5-2
- Shock and vibration resistance according to EN60068-2-27 EN60068-2-6

Housing	Flush mounting Non flush mounting	L1	L2	L3	L4	L5	Female connector	Body diameter (d)	Nominal sensing distance ( $S_r$ ) ±10%	Max switching frequency (f) in d.c.	Rated operational current ( $I_e$ )	ORDERING REFERENCES	
												NO (connectors 3 or 4 wires)	NC (connectors 4 wires)
I-11	•	-	40	12	8	60	6-8B-10	M8 x 1	1,5	1200	100	 <b>DCM8/4300S</b> <b>DCM8/5300S</b>	 <b>DCM8/4310S</b> <b>DCM8/5310S</b>
I-11	•	5	35	12	8	60	6-8B-10	M8 x 1	2,5	1000	100		
I-7	•	-	43	15	8	66	6-8B-10	M12 x 1	2	1200	200	<b>DCM12/4300KS</b> <b>DCM12/5300KS</b>	<b>DCM12/4310KS</b> <b>DCM12/5310KS</b>
I-7	•	7	36	15	8	66	6-8B-10	M12 x 1	4	1000	200		
I-12	•	-	50	19	8	77	6-8B-10	M18 x 1	5	1100	250	<b>DCM18/4300KS</b> <b>DCM18/5300KS</b>	<b>DCM18/4310KS</b> <b>DCM18/5310KS</b>
I-12	•	10	50	19	8	87	6-8B-10	M18 x 1	8	700	250		
I-2	•	-	65	17	8	90	6-8B-10	M30 x 1,5	10	800	250	<b>DCM30/4300KS</b> <b>DCM30/5300KS</b>	<b>DCM30/4310KS</b> <b>DCM30/5310KS</b>
I-2	•	15	50	17	8	90	6-8B-10	M30 x 1,5	15	400	250		

**Stainless steel sensing face •**  
**Amplified in d.c. 3 wires •**  
**Cable output •**

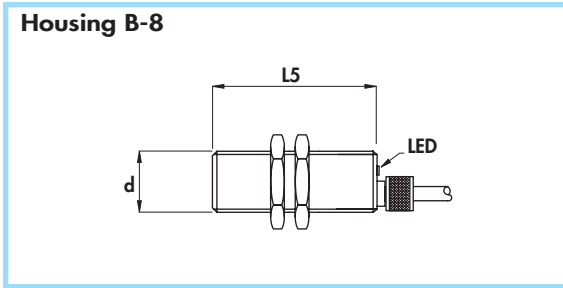

Diameter		M18 x 1
Nut	Size	SW24
	Thickness mm	4
Max tightening torque Nm		35

### Materials:

- Cable: 2 m PVC CEI 20 - 22 II; 90°C; 300 V; O.R.
- Housing: stainless steel
- Sensing face: stainless steel

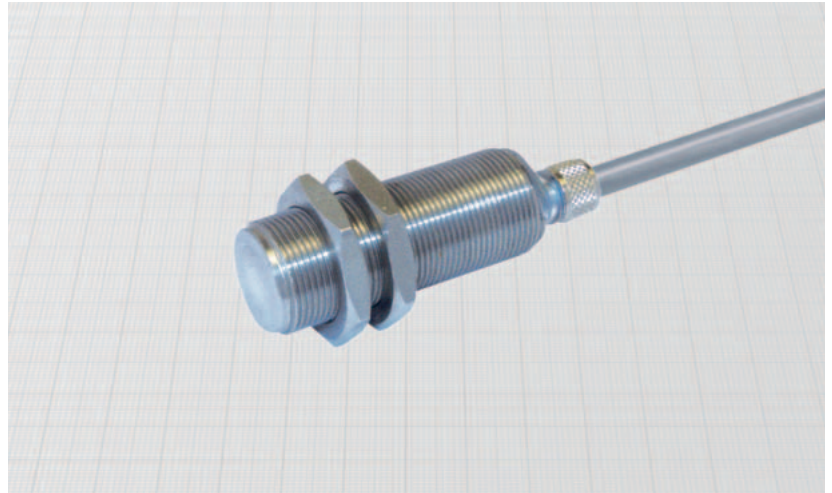

### General Features:

This particular type of sensor has increased mechanical and chemical resistance:

- **fluid ingress resistant**
- **pressure resistant**
- **corrosion resistant**
- **impact resistant**
- **vibration resistant**
- **abrasion and incandescent objects resistant**

These particular characteristics are mainly dependent by the building of the body, which is made from a single solid piece of stainless steel. The absence of junctions doesn't allow the fluid ingress through the sensing face. A very special sealing system on the back side makes of this sensor the ideal solution for the most critical applications.

### Technical data:

- Supply voltage ( $U_B$ ): 7 ÷ 40 Vdc
- Max ripple: 10%
- No-load supply current ( $I_0$ ): ≤ 10 mA
- Voltage drop ( $U_d$ ): ≤ 1,5 V
- Temperature range: -25° ÷ +75°C
- Max thermal drift of sensing distance  $S_r$ : ± 10%
- Repeat accuracy (R): 2%
- Switching hysteresis (H): 10%
- Degree of protection: IP68
- Max pressure on the front side: 50 bar
- Switch status indicator: yellow LED
- Cable conductor cross section: 0,50 mm<sup>2</sup>
- Protected against short-circuit and overload
- Protected against any wrong connection
- Suppression of initial false impulse
- Electromagnetic compatibility (EMC) according to EN60947-5-2
- Shock and vibration resistance according to EN60068-2-27 EN60068-2-6

www.bdc-sensors.com

Housing	Flush mounting (*) Non flush mounting	L1	L2	L3	L4	L5	Cable diameter	Body diameter (d)	Max switching frequency (f <sub>s</sub> )	Rated operational current (I <sub>e</sub> )	Nominal sensing distance (S <sub>n</sub> ) ± 10%	ORDERING REFERENCES			
												PNP (positive switching)			
B-8	•	-	-	-	-	45	5	M18 x 1	50	200	5			<b>DCA18/4609MKSJ</b>	<b>DCA18/4619MKSJ</b>

(\*) Note: See mounting precautions (pag. 22)

NPN (negative switching)	
Use the above mentioned part number changing the last number 9 with 8 (ie. DCA18/4608MKSJ)	

## CYLINDRICAL INDUCTIVE SENSORS IN METAL HOUSING

- Amplified in d.c. 3 wires
- High precision
- Switching hysteresis < 1  $\mu\text{m}$
- Cable output

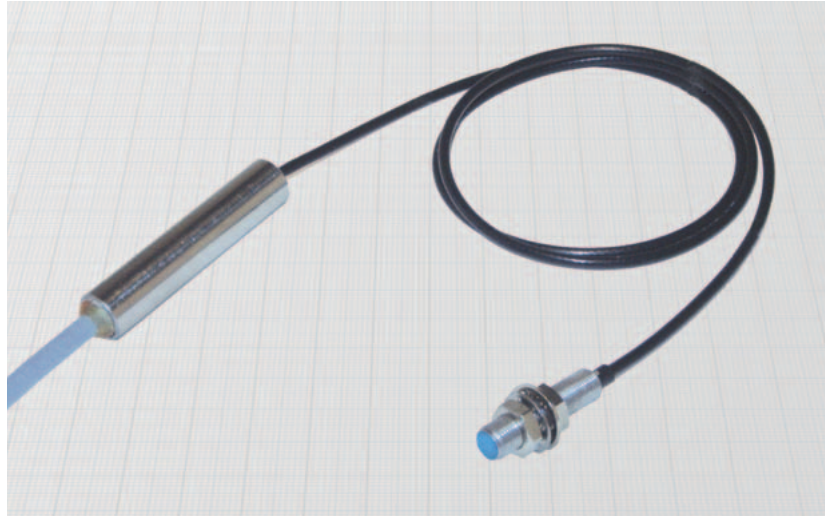

### General Features:

This unique sensor enables the detection of metallic targets with extremely high precision without contact. By using an implemented software algorithm and a laser working process it has a very stable and precise switching point with a hysteresis lower than 1  $\mu\text{m}$ .

### Applications:

- Semiconductors industry
- Quality control instruments
- High precision mechanical devices
- Calibration equipments

### Technical data:

- Supply voltage ( $U_B$ ):  $5 \div 13 \text{ Vdc}$
- Consumption:  $\leq 10 \text{ mA}$
- Voltage drop ( $I_o = 10 \text{ mA}$ ):  $\leq 0.5 \text{ V}$
- Voltage drop ( $I_o = 100 \text{ mA}$ ):  $\leq 1 \text{ V}$
- Output polarity: NPN open collector
- Output logic: normally open
- Repeat accuracy (R):  $< \pm 2 \mu\text{m}$
- Switch hysteresis (H):  $< 1 \mu\text{m}$
- Temperature range:  $10 \div 40^\circ\text{C}$
- Degree of protection: IP67
- Cable conductor cross section:  $0,22 \text{ mm}^2$
- Electromagnetic compatibility (EMC) according to EN60947-5-2 
- Shock and vibration resistance according to EN60068-2-27 EN60068-2-6

Diameter	M5 x 0,5	
Nut	Size	SW7
	Thickness mm	2,5
Max tightening torque Nm	2	

### Materials:

- Cable: [www.khatech.com/Lineart](http://www.khatech.com/Lineart) 2 m PVC CEI 20 - 22 II; 90°C
- Housing sensor and amplifier: stainless steel

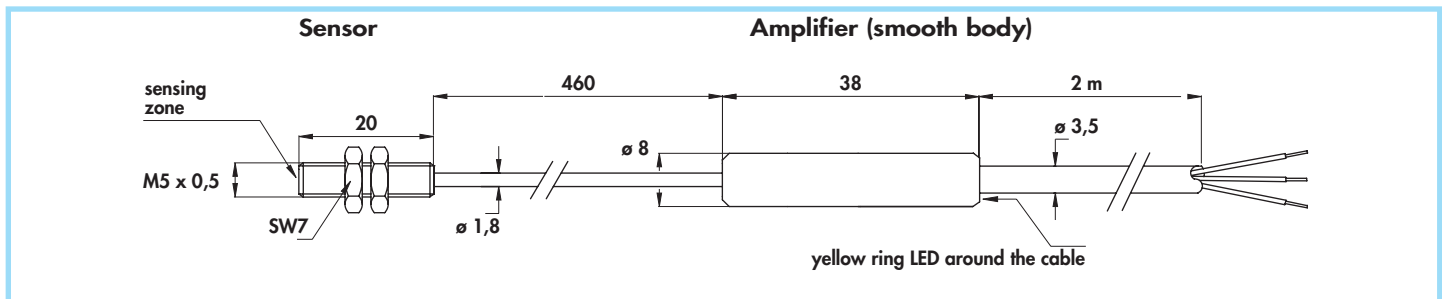

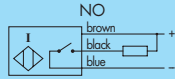
Flush mounting Non flush mounting	Cable diameter	Sensor diameter	Amplifier diameter	Rated operational current ( $I_o$ )	Max switching frequency (f)	Nominal sensing distance ( $S_n$ ) $\pm 10\%$	ORDERING REFERENCES	
							NPN (negative switching)	
	mm	mm	mm	mA	Hz	mm		
•	3,5	M5 x 0,5	8	100	100	0,9	IPS05/4608KS	