

4825898 INTEGRATED POWER

82D 00284 D

7-58-11-23

INTEGRATED POWER

SEMICONDUCTORS, LTD.

1.5 Amp Positive Adjustable Regulators

Description

The IP117A Series are three terminal positive adjustable voltage regulators capable of supplying in excess of 1.5A over a 1.25V to 60V output range. These regulators are exceptionally easy to use and require only two external resistors to set the output voltage. In addition to improved line and load regulation, a major feature of the "A" series is the initial output voltage tolerance, which is guaranteed to be less than 1%. Over full operating conditions, including load, line, and power dissipation, the reference voltage is guaranteed not to vary more than 2%. These devices exhibit current limit, thermal overload protection, and improved power device safe operating area protection, making them essentially indestructible.

Features

- Guaranteed 1% output voltage tolerance
- Guaranteed 0.3% load regulation
- Guaranteed 0.01%/V line regulation
- Internal current limiting constant with temperature
- Internal thermal overload protection
- Improved output transistor safe operating area compensation
- Output adjustable between 1.25V and 60V
- 100% thermal limit burn-in

Connections

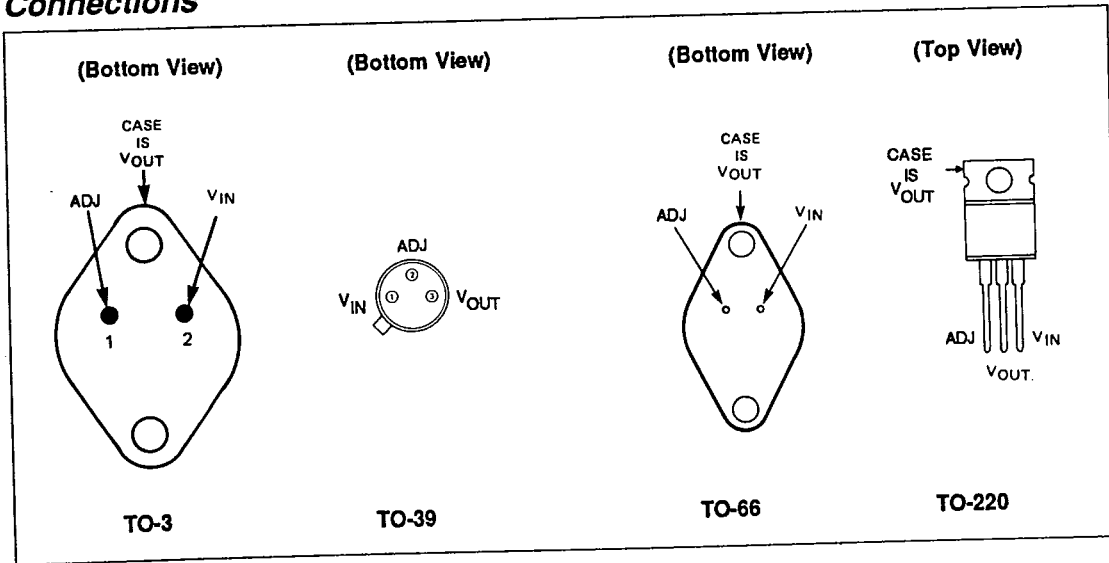

Section 5 - Voltage Regulators
 IP117A, IP217A, IP317A, LM117, LM217, LM317,
 IP117AHV, IP217AHV, IP317AHV,
 LM117HV, LM217HV, LM317HV

Absolute Maximum Ratings

Power Dissipation	Internally Limited	Input to Output Voltage Differential	
Operating Junction Temperature Range		Non-HV	40V
117AHV/117A/117HV/117	-55°C to +150°C	HV Series	60V
217AHV/217A/217HV/217	-25°C to +150°C	Storage Temperature Range	-65°C to +150°C
317AHV/317A/317HV/317	0°C to +125°C	Lead Temperature (Soldering, 10 seconds)	300°C

Absolute maximum ratings are those values beyond which the safety of the device cannot be guaranteed. They are not meant to imply that the device should be operated at these limits. The electrical characteristics provide conditions for actual device operation.

Electrical Characteristics (Notes 1 and 3)

Parameter	Test Conditions	IP117AHV IP217AHV IP117A IP217A			LM117HV LM217HV LM117 LM217			Units	
		Min	Typ	Max	Min	Typ	Max		
Reference Voltage, V_{REF}	$I_{OUT} = 10\text{ mA}$	1.238	1.250	1.262				V	
	$3\text{V} \leq (V_{IN} - V_{OUT}) \leq V_{MAX}$ $10\text{ mA} \leq I_{OUT} \leq I_{MAX}, P \leq P_{MAX}$	• 1.225	1.250	1.270	1.200	1.250	1.300	V	
Line Regulation, $\frac{\Delta V_{OUT}}{\Delta V_{IN}}$	$3\text{V} \leq (V_{IN} - V_{OUT}) \leq V_{MAX}$ (See Note 2)		0.005	0.010		0.010	0.020	%/V	
			0.010	0.020		0.020	0.050	%/V	
Load Regulation, $\frac{\Delta V_{OUT}}{\Delta I_{OUT}}$	$10\text{ mA} \leq I_{OUT} \leq I_{MAX}$ (See Note 2)	$V_{OUT} \leq 5\text{V}$		5	15		5	15	mV
		$V_{OUT} \geq 5\text{V}$		0.1	0.3		0.1	0.3	%
		$V_{OUT} \leq 5\text{V}$	•	15	50		20	50	mV
		$V_{OUT} \geq 5\text{V}$	•	0.3	1.0		0.3	1.0	%
Thermal Regulation	20 msec Pulse		0.002	0.020		0.030	0.070	%/W	
Ripple Rejection	$V_{OUT} = 10\text{V}$, $f = 120\text{ Hz}$	$C_{ADJ} = 0$		65		65		dB	
		$C_{ADJ} = 10\mu\text{F}$	• 66	80		66	80	dB	
Adjust Pin Current, I_{ADJ}			50	100		50	100	μA	
Adjust Pin Current Change, ΔI_{ADJ}	$10\text{ mA} \leq I_{OUT} \leq I_{MAX}$, $2.5\text{V} \leq (V_{IN} - V_{OUT}) \leq V_{MAX}$	•	0.2	5		0.2	5	μA	
Minimum Load Current, I_{MIN}	$(V_{IN} - V_{OUT}) = 40\text{V}$	•	3.5	5		3.5	5	mA	
	$(V_{IN} - V_{OUT}) = 60\text{V}$, HV Series	•	3.5	7		3.5	7	mA	
Current Limit, I_{CL}	$(V_{IN} - V_{OUT}) \leq 15\text{V}$	K, R Package	• 1.5	2.2		1.5	2.2	A	
		H Package	• 0.50	0.80		0.50	0.80	A	
	$(V_{IN} - V_{OUT}) = 40\text{V}$	K, R Package		0.30	0.50		0.30	0.50	A
		H Package		0.15	0.20		0.15	0.20	A
	$(V_{IN} - V_{OUT}) = 60\text{V}$ HV Series	K, R Package			0.10			0.10	A
		H Package			0.03			0.03	A
Temperature Stability, $\frac{\Delta V_{OUT}}{\Delta \text{TEMP}}$		•	1	2		1		%	
Long Term Stability, $\frac{\Delta V_{OUT}}{\Delta \text{TIME}}$	$T_A = 125^\circ\text{C}$, 1000 Hrs.			0.3	1		0.3	1	%
RMS Output Noise (% of V_{OUT}), θ_n	$10\text{ Hz} \leq f \leq 10\text{ kHz}$			0.001			0.001		%
Thermal Resistance Junction to Case, θ_{jc}	K Package			2.3	3		2.3	3	$^\circ\text{C/W}$
	R Package			5	7		5	7	$^\circ\text{C/W}$
	H Package			12	15		12	15	$^\circ\text{C/W}$

Section 5 - Voltage Regulators
 IP117A, IP217A, IP317A, LM117, LM217, LM317,
 IP117AHV, IP217AHV, IP317AHV,
 LM117HV, LM217HV, LM317HV



7-58-11-23

Electrical Characteristics

Parameter	Test Conditions	IP317AHVA IP317A			LM317HV LM317			Units	
		Min	Typ	Max	Min	Typ	Max		
Reference Voltage, V_{REF}	$I_{OUT} = 10\text{ mA}$	1.238	1.250	1.262				V	
	$3V \leq (V_{IN} - V_{OUT}) \leq V_{MAX}$ $10\text{ mA} \leq I_{OUT} \leq I_{MAX}, P \leq P_{MAX}$	• 1.225	1.250	1.270	1.200	1.250	1.300	V	
Line Regulation, $\frac{\Delta V_{OUT}}{\Delta V_{IN}}$	$3V \leq (V_{IN} - V_{OUT}) \leq V_{MAX}$ (See Note 2)		0.005	0.010		0.010	0.040	%/V	
			0.010	0.020		0.020	0.070	%/V	
Load Regulation, $\frac{\Delta V_{OUT}}{\Delta I_{OUT}}$	$10\text{ mA} \leq I_{OUT} \leq I_{MAX}$ (See Note 2)	$V_{OUT} \leq 5V$		5	25		5	25	mV
		$V_{OUT} \geq 5V$		0.1	0.5		0.1	0.5	%
		$V_{OUT} \leq 5V$ •		15	50		20	70	mV
		$V_{OUT} \geq 5V$ •		0.3	1.0		0.3	1.5	%
Thermal Regulation	20 msec Pulse		0.002	0.020		0.030	0.070	%/W	
Ripple Rejection	$V_{OUT} = 10V,$ $f = 120\text{ Hz}$	$C_{ADJ} = 0\mu F$		65			65		dB
		$C_{ADJ} = 10\mu F$ •	66	80		66	80		dB
Adjust Pin Current, I_{ADJ}				50	100		50	100	μA
Adjust Pin Current Change, ΔI_{ADJ}	$10\text{ mA} \leq I_{OUT} \leq I_{MAX},$ $2.5V \leq (V_{IN} - V_{OUT}) \leq V_{MAX}$			0.2	5		0.2	5	μA
Minimum Load Current, I_{MIN}	$(V_{IN} - V_{OUT}) = 40V$			3.5	10		3.5	10	mA
	$(V_{IN} - V_{OUT}) = 60V$			3.5	12		3.5	12	mA
Current Limit, I_{CL}	$(V_{IN} - V_{OUT}) \leq 15V$	K, R, T Package •	1.5	2.2		1.5	2.2		A
		H Package •	0.50	0.80		0.50	0.80		A
	$(V_{IN} - V_{OUT}) = 40V$	K, R, T Package	0.15	0.40		0.15	0.40		A
		H Package	0.075	0.20		0.075	0.20		A
	$(V_{IN} - V_{OUT}) = 60V$	K, R, T Package		0.10			0.10		A
		H Package		0.03			0.03		A
Temperature Stability, $\frac{\Delta V_{OUT}}{\Delta TEMP}$	$T_{MIN} \leq T_j \leq T_{MAX}$			1	2		1		%
Long Term Stability, $\frac{\Delta V_{OUT}}{\Delta TIME}$	1000 Hrs.			0.3	1		0.3	1	%
RMS Output Noise (% of V_{OUT}), e_n	$10\text{ Hz} \leq f \leq 10\text{ kHz}$			0.003			0.003		%
Thermal Resistance Junction to Case, θ_{JC}	K Package			2.3	3		2.3	3	$^{\circ}C/W$
	R Package			5	7		5	7	$^{\circ}C/W$
	T Package			4	5		4	5	$^{\circ}C/W$
	H Package			12	15		12	15	$^{\circ}C/W$

The • denotes the specifications which apply over the full operating temperature range, all others apply at $T_j = 25^{\circ}C$ unless otherwise specified.

Note 1. Unless otherwise specified, $V_{IN} - V_{OUT} = 5V$, and $I_{OUT} = 0.1A$ for the TO-39 (H) Package, and $I_{OUT} = 0.5A$ for the TO-3 (K), TO-66 (R), and TO-220 (T) Packages. Although power dissipation is internally limited, these specifications apply for dissipations up to 2W for the TO-39, and 20W for the TO-3, TO-66 and TO-220. $I_{MAX} = 0.5A$ for the TO-39 and 1.5A for the TO-3, TO-66, and TO-220.

Note 2. Regulation is measured at constant junction temperature, using pulse testing at a low duty cycle. Changes in output voltage due to heating effects are covered under thermal regulation specifications. Load regulation is measured from the bottom of the package for the TO-3, and TO-66, and at the junction of the wide and narrow portion of the output lead for the TO-220, and 1/8" below the base of the package on the output pin of the TO-39.

Note 3. $V_{MAX} = 40V$ for IP117A, IP217A, IP317A, LM117, LM217, LM317.
 $V_{MAX} = 60V$ for IP117AHV, IP217AHV, IP317AHV, LM117HV, LM217HV, LM317HV.

Section 5 - Voltage Regulators
 IP117A, IP217A, IP317A, LM117, LM217, LM317,
 IP117AHV, IP217AHV, IP317AHV,
 LM117HV, LM217HV, LM317HV



T-58-11-23

Typical Performance Characteristics

Load Regulation

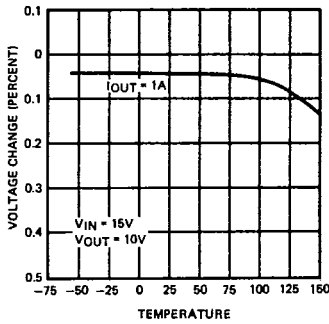

Output Impedance

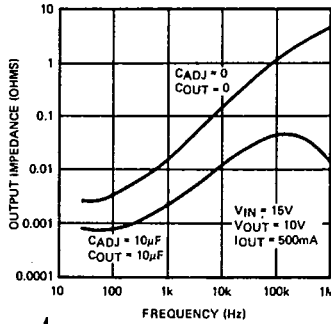

Adjustment Current

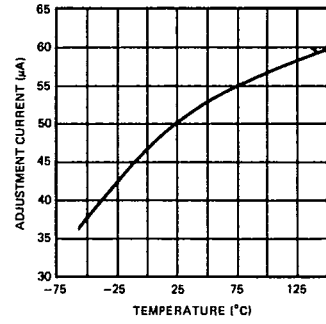

Dropout Voltage

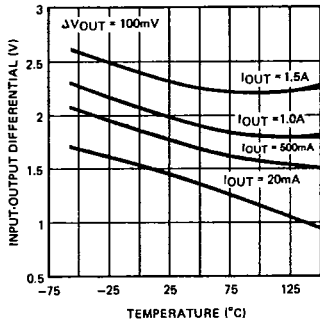

Temperature Stability

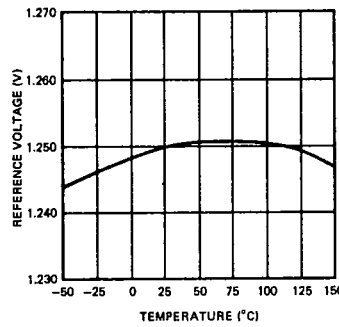

Minimum Operating Current

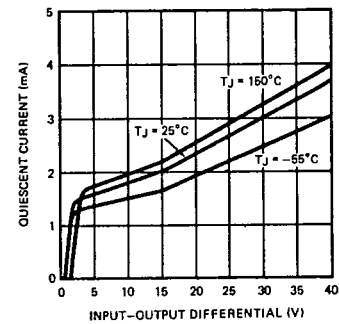

Ripple Rejection

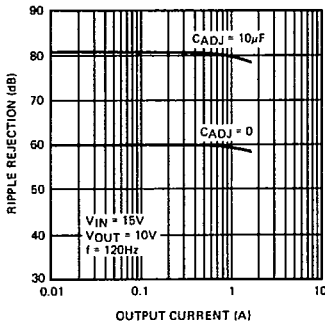

Ripple Rejection

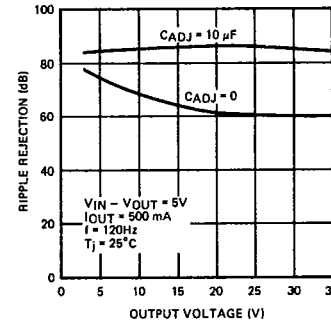

Ripple Rejection

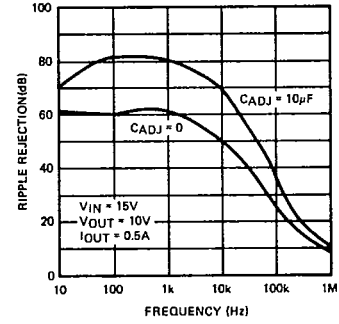

Current Limit TO-3, TO-66 and TO-220

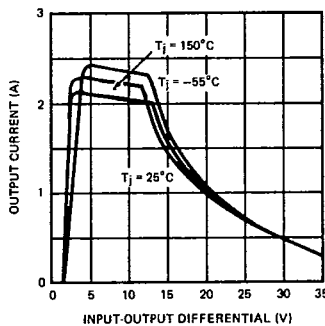

Current Limit TO-3, TO-66 and TO-220

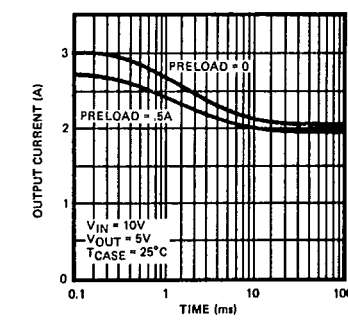

Current Limit TO-3, TO-66 and TO-220

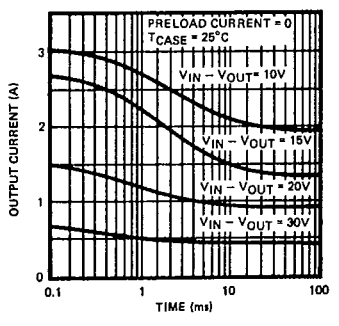

Section 5 - Voltage Regulators
 IP117A, IP217A, IP317A, LM117, LM217, LM317,
 IP117AHV, IP217AHV, IP317AHV,
 LM117HV, LM217HV, LM317HV



T-58-11-23

Typical Performance Characteristics (Cont.)

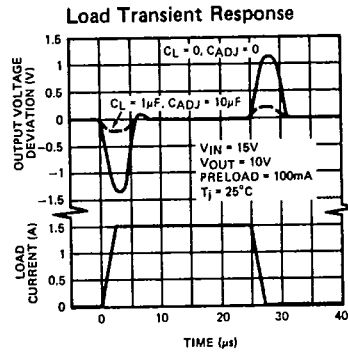
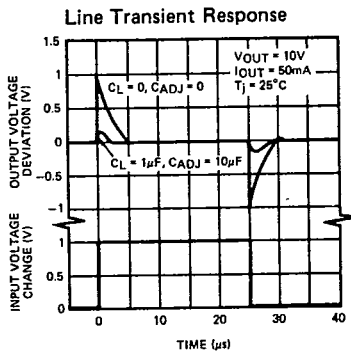

Applications Information

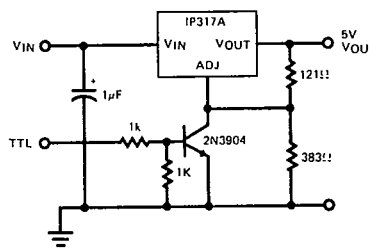
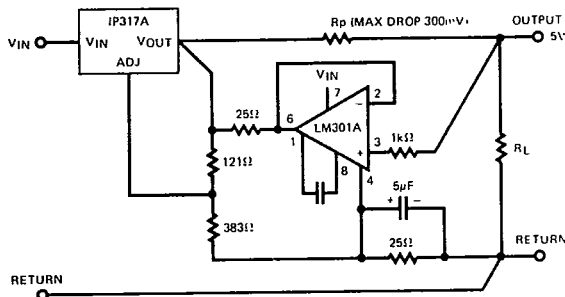

5V Regulator with Shut Down

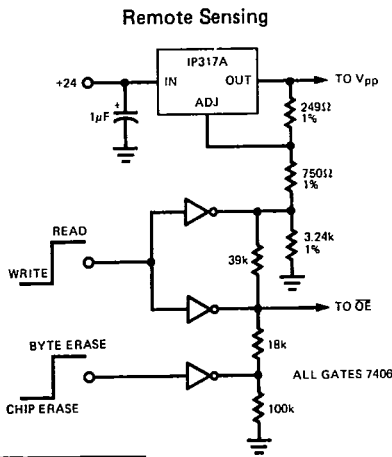

	OE	V_{pp}
READ	0V	5V
WRITE		
BYTE ERASE	5V	21V
CHIP ERASE	12V	21V

2816 EEPROM Supply Programmer for Read/Write Control

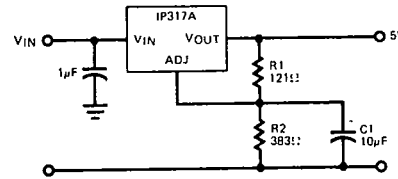

Improving Ripple Rejection

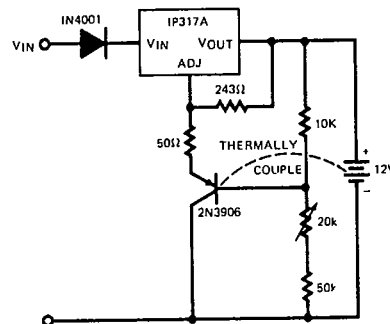

Temperature Compensated Lead Acid Battery Charger

Section 5 - Voltage Regulators
 IP117A, IP217A, IP317A, LM117, LM217, LM317,
 IP117AHV, IP217AHV, IP317AHV,
 LM117HV, LM217HV, LM317HV

4825898 INTEGRATED POWER

82D 00289 D

T-58-11-23

Order Information

Part Number	Temperature Range	Package
IP117AK/IP117AHVK/LM117K/LM117HVK	-55°C to +150°C	TO-3
IP117AH/IP117AHVH/LM117H/LM117HVH	-55°C to +150°C	TO-39
IP117AR/IP117AHVR/IP117R/IP117HVR	-55°C to +150°C	TO-66
IP117AG/IP117AHVG/IP117G/IP117HVG	-55°C to +150°C	Hermetic TO-220
IP217AK/IP217AHVK/LM217K/LM217HVK	-25°C to +150°C	TO-3
IP217AR/IP217AHVR/IP217R/IP227HVR	-25°C to +150°C	TO-66
IP317AK/IP317AHVK/LM317K/LM317HVK	0°C to +125°C	TO-3
IP317AR/IP317AHVR/IP317R/IP317HVR	0°C to +125°C	TO-66
IP317AT/IP317AHVT/LM317T/LM317HVT	0°C to +125°C	TO-220

Section 5 - Voltage Regulators
 IP117A, IP217A, IP317A, LM117, LM217, LM317,
 IP117AHV, IP217AHV, IP317AHV,
 LM117HV, LM217HV, LM317HV

Integrated Power Semiconductors, Ltd. cannot assume responsibility for use of any circuitry other than circuitry entirely embodied in an Integrated Power product. No circuit patent licenses are implied. Integrated Power reserves the right to change the circuitry and specifications without notice at any time.

Integrated Power Semiconductors, Ltd.

2727 Walsh Avenue, Suite 201, Santa Clara, CA 95051 • Telephone: 408-727-2772 • Telex: 350073 (IPS SNTA) • FAX: 408-988-6185
 8 Quaker Drive, West Warwick, RI 02893 • Telephone: 401-821-4260 • Telex: 332948 (IPS RI) • FAX: 401-823-7260
 2081 Business Center Drive, Suite 140, Irvine, CA 92715 • Telephone: 714-752-0188 • FAX: 714-752-5019
 789 Turnpike Street, North Andover, MA 01845 • Telephone: 617-683-9042 • FAX: 617-975-0193

