

**MM54C00/MM74C00 Quad 2-Input NAND Gate**  
**MM54C02/MM74C02 Quad 2-Input NOR Gate**  
**MM54C04/MM74C04 Hex Inverter**  
**MM54C10/MM74C10 Triple 3-Input NAND Gate**  
**MM54C20/MM74C20 Dual 4-Input NAND Gate**

**General Description**

These logic gates employ complementary MOS (CMOS) to achieve wide power supply operating range, low power consumption, high noise immunity and symmetric controlled rise and fall times. With features such as this the 54C/74C logic family is close to ideal for use in digital systems. Function and pin out compatibility with series 54/74 devices minimizes design time for those designers already familiar with the standard 54/74 logic family.

All inputs are protected from damage due to static discharge by diode clamps to  $V_{CC}$  and GND.

**Features**

- Wide supply voltage range 3V to 15V
- Guaranteed noise margin 1V
- High noise immunity 0.45  $V_{CC}$  (typ.)
- Low power consumption 10 nW/package (typ.)
- Low power Fan out of 2 driving 74L TTL compatibility

**Connection Diagrams**

**Dual-In-Line Packages**

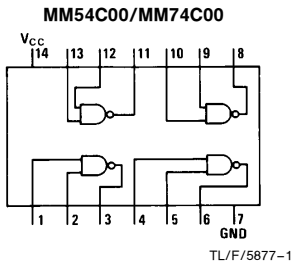

**Top View**  
 Order Number MM54C00 or MM74C00

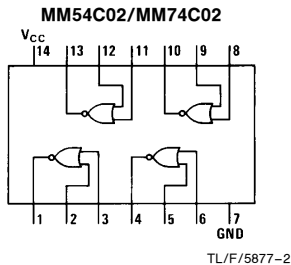

**Top View**  
 Order Number MM54C02 or MM74C02

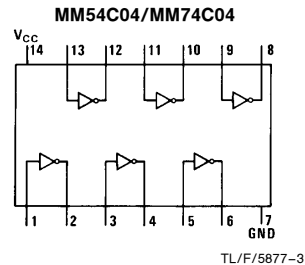

**Top View**  
 Order Number MM54C04 or MM74C04

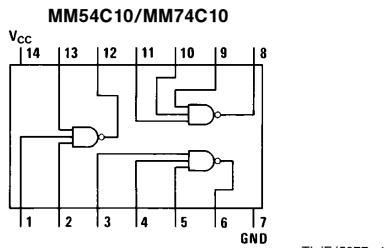

**Top View**  
 Order Number MM54C10 or MM74C10

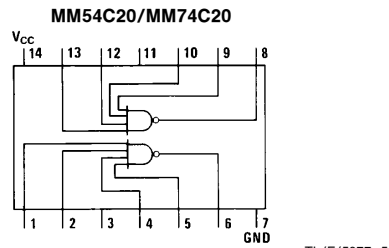

**Top View**  
 Order Number MM54C20 or MM74C20

MM54C00/MM74C00, MM54C02/MM74C02, MM54C04/MM74C04, MM54C10/MM74C10, MM54C20/MM74C20

## Absolute Maximum Ratings

If Military/Aerospace specified devices are required, please contact the National Semiconductor Sales Office/Distributors for availability and specifications.

Voltage at Any Pin	-0.3V to $V_{CC} + 0.3V$
Operating Temperature Range	
54C	-55°C to +125°C
74C	-40°C to +85°C
Storage Temperature Range	-65°C to +150°C

Operating $V_{CC}$ Range	3.0V to 15V
Maximum $V_{CC}$ Voltage	18V
Power Dissipation ( $P_D$ )	
Dual-In-Line	700 mW
Small Outline	500 mW
Lead Temperature (Soldering, 10 seconds)	300°C

## DC Electrical Characteristics

Min/Max limits apply across the guaranteed temperature range unless otherwise noted

Symbol	Parameter	Conditions	Min	Typ	Max	Units
<b>CMOS TO CMOS</b>						
$V_{IN(1)}$	Logical "1" Input Voltage	$V_{CC} = 5.0V$	3.5			V
		$V_{CC} = 10V$	8.0			V
$V_{IN(0)}$	Logical "0" Input Voltage	$V_{CC} = 5.0V$			1.5	V
		$V_{CC} = 10V$			2.0	V
$V_{OUT(1)}$	Logical "1" Output Voltage	$V_{CC} = 5.0V, I_O = -10 \mu A$	4.5			V
		$V_{CC} = 10V, I_O = -10 \mu A$	9.0			V
$V_{OUT(0)}$	Logical "0" Output Voltage	$V_{CC} = 5.0V, I_O = 10 \mu A$			0.5	V
		$V_{CC} = 10V, I_O = 10 \mu A$			1.0	V
$I_{IN(1)}$	Logical "1" Input Current	$V_{CC} = 15V, V_{IN} = 15V$		0.005	1.0	$\mu A$
$I_{IN(0)}$	Logical "0" Input Current	$V_{CC} = 15V, V_{IN} = 0V$	-1.0	-0.005		$\mu A$
$I_{CC}$	Supply Current	$V_{CC} = 15V$		0.01	15	$\mu A$
<b>LOW POWER TO CMOS</b>						
$V_{IN(1)}$	Logical "1" Input Voltage	54C, $V_{CC} = 4.5V$	$V_{CC} - 1.5$			V
		74C, $V_{CC} = 4.75V$	$V_{CC} - 1.5$			V
$V_{IN(0)}$	Logical "0" Input Voltage	54C, $V_{CC} = 4.5V$			0.8	V
		74C, $V_{CC} = 4.75V$			0.8	V
$V_{OUT(1)}$	Logical "1" Output Voltage	54C, $V_{CC} = 4.5V, I_O = -10 \mu A$	4.4			V
		74C, $V_{CC} = 4.75V, I_O = -10 \mu A$	4.4			V
$V_{OUT(0)}$	Logical "0" Output Voltage	54C, $V_{CC} = 4.5V, I_O = 10 \mu A$			0.4	V
		74C, $V_{CC} = 4.75V, I_O = 10 \mu A$			0.4	V
<b>CMOS TO LOW POWER</b>						
$V_{IN(1)}$	Logical "1" Input Voltage	54C, $V_{CC} = 4.5V$	4.0			V
		74C, $V_{CC} = 4.75V$	4.0			V
$V_{IN(0)}$	Logical "0" Input Voltage	54C, $V_{CC} = 4.5V$			1.0	V
		74C, $V_{CC} = 4.75V$			1.0	V
$V_{OUT(1)}$	Logical "1" Output Voltage	54C, $V_{CC} = 4.5V, I_O = -360 \mu A$	2.4			V
		74C, $V_{CC} = 4.75V, I_O = -360 \mu A$	2.4			V
$V_{OUT(0)}$	Logical "0" Output Voltage	54C, $V_{CC} = 4.5V, I_O = 360 \mu A$			0.4	V
		74C, $V_{CC} = 4.75V, I_O = 360 \mu A$			0.4	V
<b>OUTPUT DRIVE (see 54C/74C Family Characteristics Data Sheet) <math>T_A = 25^\circ C</math> (short circuit current)</b>						
$I_{SOURCE}$	Output Source Current	$V_{CC} = 5.0V, V_{IN(0)} = 0V, V_{OUT} = 0V$	-1.75			mA
$I_{SOURCE}$	Output Source Current	$V_{CC} = 10V, V_{IN(0)} = 0V, V_{OUT} = 0V$	-8.0			mA
$I_{SINK}$	Output Sink Current	$V_{CC} = 5.0V, V_{IN(1)} = 5.0V, V_{OUT} = V_{CC}$	1.75			mA
$I_{SINK}$	Output Sink Current	$V_{CC} = 10V, V_{IN(1)} = 10V, V_{OUT} = V_{CC}$	8.0			mA

## AC Electrical Characteristics\* $T_A = 25^\circ\text{C}$ , $C_L = 50\text{ pF}$ , unless otherwise specified

Symbol	Parameter	Conditions	Min	Typ	Max	Units
<b>MM54C00/MM74C00, MM54C02/MM74C02, MM54C04/MM74C04</b>						
$t_{pd0}$ , $t_{pd1}$	Propagation Delay Time to Logical "1" or "0"	$V_{CC} = 5.0\text{V}$		50	90	ns
		$V_{CC} = 10\text{V}$		30	60	ns
$C_{IN}$	Input Capacitance	(Note 2)		6.0		pF
$C_{PD}$	Power Dissipation Capacitance	(Note 3) Per Gate or Inverter		12		pF
<b>MM54C10/MM74C10</b>						
$t_{pd0}$ , $t_{pd1}$	Propagation Delay Time to Logical "1" or "0"	$V_{CC} = 5.0\text{V}$		60	100	ns
		$V_{CC} = 10\text{V}$		35	70	ns
$C_{IN}$	Input Capacitance	(Note 2)		7.0		pF
$C_{PD}$	Power Dissipation Capacitance	(Note 3) Per Gate		18		pF
<b>MM54C20/MM74C20</b>						
$t_{pd0}$ , $t_{pd1}$	Propagation Delay Time to Logical "1" or "0"	$V_{CC} = 5.0\text{V}$		70	115	ns
		$V_{CC} = 10\text{V}$		40	80	ns
$C_{IN}$	Input Capacitance	(Note 2)		9		pF
$C_{PD}$	Power Dissipation Capacitance	(Note 3) Per Gate		30		pF

\*AC Parameters are guaranteed by DC correlated testing.

**Note 1:** "Absolute Maximum Ratings" are those values beyond which the safety of the device cannot be guaranteed. Except for "Operating Temperature Range" they are not meant to imply that the devices should be operated at these limits. The table of "Electrical Characteristics" provides conditions for actual device operation.

**Note 2:** Capacitance is guaranteed by periodic testing.

**Note 3:**  $C_{PD}$  determines the no load AC power consumption of any CMOS device. For complete explanation see 54C/74C Family Characteristics Application Note—AN-90.

## Typical Performance Characteristics

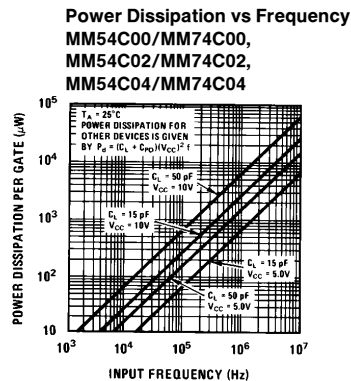
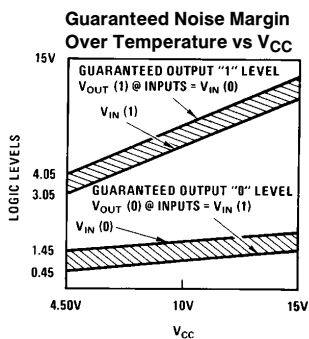
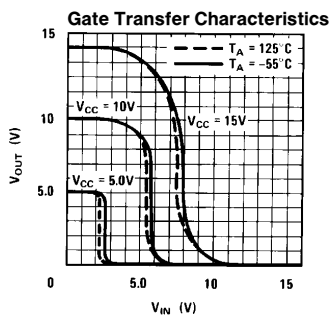

TL/F/5877-6

## Typical Performance Characteristics (Continued)

Propagation Delay vs Ambient Temperature  
MM54C00/MM74C00,  
MM54C02/MM74C02,  
MM54C04/MM74C04

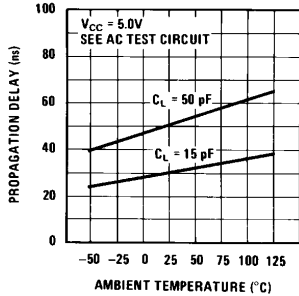

Propagation Delay vs Ambient Temperature  
MM54C00/MM74C00,  
MM54C02/MM74C02,  
MM54C04/MM74C04

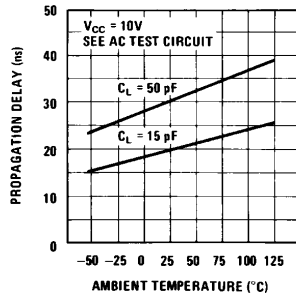

Propagation Delay Time vs Load Capacitance  
MM54C00/MM74C00,  
MM54C02/MM74C02,  
MM54C04/MM74C04

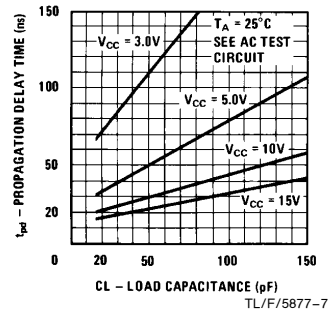

Propagation Delay Time vs Load Capacitance  
MM54C10/MM74C10

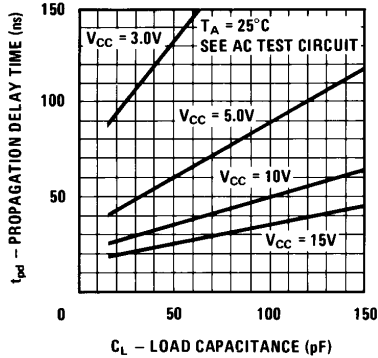

Propagation Delay Time vs Load Capacitance  
MM54C20/MM74C20

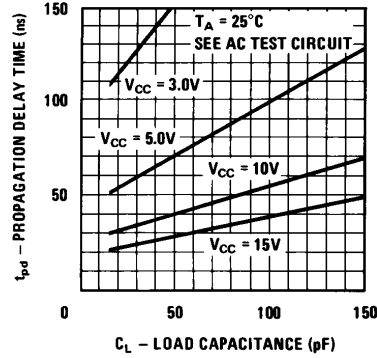

## Switching Time Waveforms and AC Test Circuit

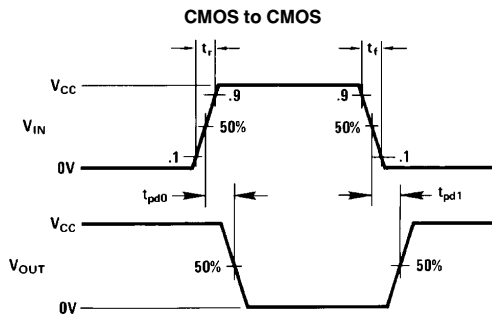

TL/F/5877-10

Note: Delays measured with input  $t_r, t_f \leq 20 \text{ ns}$ .

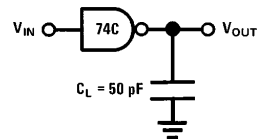

TL/F/5877-11

**Physical Dimensions** inches (millimeters)

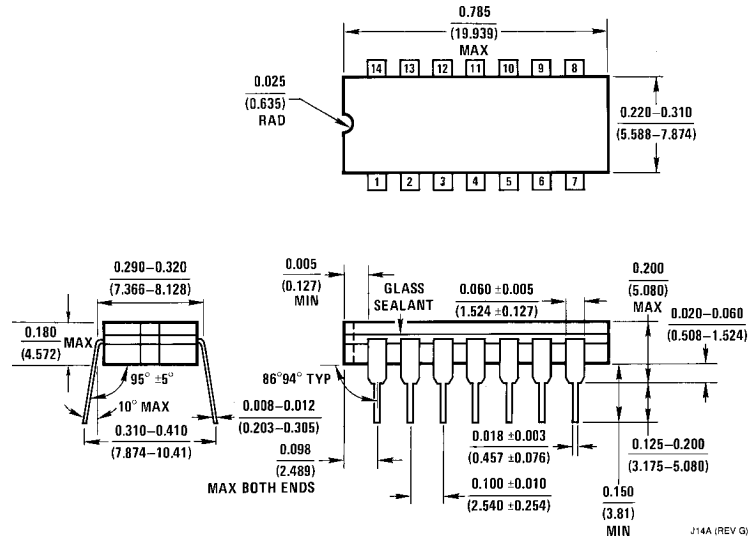

**Ceramic Dual-In-Line Package (J)**  
**Order Number MM54C00J, MM54C02J, MM54C04J, MM54C10J, MM54C20J,**  
**MM74C00J, MM74C02J, MM74C04J, MM74C10J or MM74C20J**  
**NS Package Number J14A**

**Physical Dimensions** inches (millimeters) (Continued)

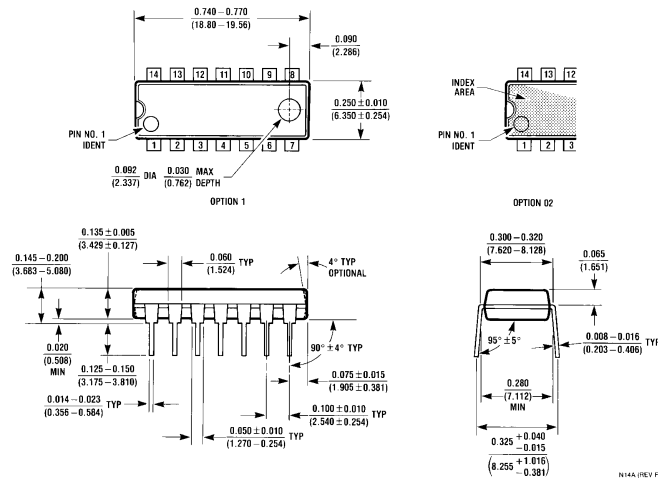

**Molded Dual-In-Line Package (N)**  
**Order Number MM54C00N, MM54C02N, MM54C04N, MM54C10N, MM54C20N,**  
**MM74C00N, MM74C02N, MM74C04N, MM74C10N or MM74C20N**  
**NS Package Number N14A**

**LIFE SUPPORT POLICY**

NATIONAL'S PRODUCTS ARE NOT AUTHORIZED FOR USE AS CRITICAL COMPONENTS IN LIFE SUPPORT DEVICES OR SYSTEMS WITHOUT THE EXPRESS WRITTEN APPROVAL OF THE PRESIDENT OF NATIONAL SEMICONDUCTOR CORPORATION. As used herein:

1. Life support devices or systems are devices or systems which, (a) are intended for surgical implant into the body, or (b) support or sustain life, and whose failure to perform, when properly used in accordance with instructions for use provided in the labeling, can be reasonably expected to result in a significant injury to the user.
2. A critical component is any component of a life support device or system whose failure to perform can be reasonably expected to cause the failure of the life support device or system, or to affect its safety or effectiveness.



**National Semiconductor Corporation**  
 1111 West Bardin Road  
 Arlington, TX 76017  
 Tel: 1(800) 272-9959  
 Fax: 1(800) 737-7018

**National Semiconductor Europe**  
 Fax: (+49) 0-180-530 85 86  
 Email: cnjwge@tevm2.nsc.com  
 Deutsch Tel: (+49) 0-180-530 85 85  
 English Tel: (+49) 0-180-532 78 32  
 Français Tel: (+49) 0-180-532 93 58  
 Italiano Tel: (+49) 0-180-534 16 80

**National Semiconductor Hong Kong Ltd.**  
 19th Floor, Straight Block,  
 Ocean Centre, 5 Canton Rd.  
 Tsimshatsui, Kowloon  
 Hong Kong  
 Tel: (852) 2737-1600  
 Fax: (852) 2736-9960

**National Semiconductor Japan Ltd.**  
 Tel: 81-043-299-2309  
 Fax: 81-043-299-2408

National does not assume any responsibility for use of any circuitry described, no circuit patent licenses are implied and National reserves the right at any time without notice to change said circuitry and specifications.