

## MM5437 Digital Noise Source

### General Description

The MM5437 device is a monolithic metal gate NMOS integrated circuit which may be used as a digital noise source or a pseudo-random number generator. The part is designed to produce a broadband white noise signal with uniform noise quality and output amplitude. Two outputs are provided. The first, OUT 1, is sequence-limited to reduce "thumps." The other output, OUT 2, is the last stage of the shift register when CONTROL 2 is left floating or is pulled up. Typical cycle time is one minute. Data is clocked in and out on the rising edge of the clock.

### Applications

- Electronic musical rhythm instrument sound generators
- Music synthesizer white and pink noise generators
- Room acoustics testing/equalization
- Pseudo-random number generator

### Features

- Internal self-contained oscillator
- Single supply voltage range of 4.5V to 11V
- TTL compatible at 5V
- Normal and sequence-limited outputs
- Low power consumption
- One minute cycle time
- External loading and clocking capability
- Automatic reset for all-zeros state
- Uniform noise quality
- Uniform noise amplitude
- Eliminate noise preamps
- Single component insertion

### Block and Connection Diagrams

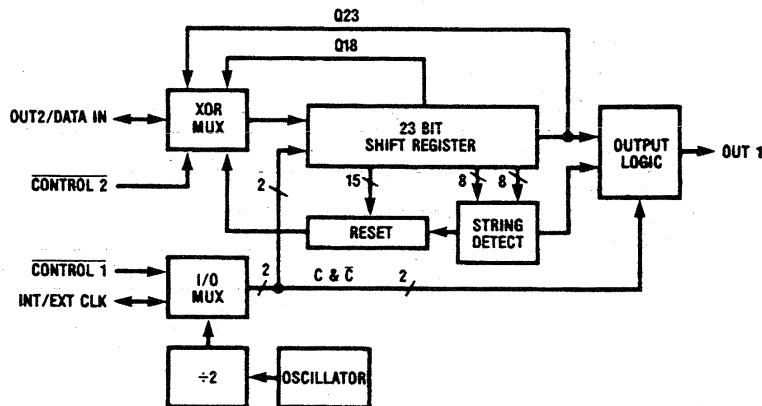

TL/F/5260-1

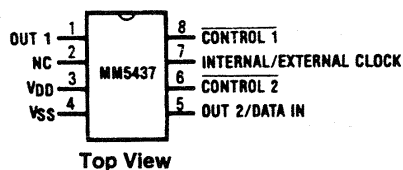

TL/F/5260-2

Order Number **MM5437N**  
See NS Package Number **N08E**

## Absolute Maximum Ratings

Operating Supply Voltage, $V_{DD}$	12V
Storage Temperature, $T_S$	-65°C to +150°C
Operating Temperature, $T_A$	-40°C to +85°C
DC Output Current, per pin	±12 mA
Lead Temp. (Soldering, 10 seconds)	+300°C

*Absolute Maximum Ratings indicate limits beyond which damage to the device may occur.*

## DC Electrical Characteristics $T_A$ within operating range, $V_{SS} = 0V$ , $V_{DD} = 11V$ , unless specified

Parameter	Conditions	Min	Typ	Max	Units
Supply Voltage ( $V_{DD}$ )		4.5		11	V
Supply Current ( $I_{DD}$ )	$V_{DD} = 4.5V$ (No load) $V_{DD} = 11V$ (No load)			4 5	mA mA
Output Voltage Levels					
Logic '0'	$I_{OL} = +1.6$ mA, $V_{DD} = 4.5V$	$V_{SS}$		0.4	V
Logic '1'	$I_{OH} = -400$ $\mu$ A, $V_{DD} = 4.5V$	2.4		$V_{DD}$	V
Input Voltage Levels				0.8	
Logic '0'					
Logic '1'		2.0			V
Input Currents					
Logic '0'	$V_{IN} = 0.4V$			200	$\mu$ A
Logic '1'	$V_{IN} = 2.4V$			200	$\mu$ A
Half Power Point*		30		140	kHz
Cycle Time		25		110	sec.

\*Half Power Point = 0.45 (Shift Register Clock Frequency)

## AC Timing $-40^\circ C \leq T_A \leq +85^\circ C$ $4.5V \leq V_{DD} \leq 11V$

Symbol	Parameter	Min	Max	Units
$t_S$	Data Set Up Time Prior to Clock	100		ns
$t_H$	Data Hold Time After Clock	100		ns
$t_{C2DV}$	$\overline{CONTROL 2}$ to Data Out Valid		100	ns
$t_{CLKDV}$	Clock to Data Out Valid		700	ns
$t_{PH}$	Clock Pulse Width High	1.5		$\mu$ s
$t_{PL}$	Clock Pulse Width Low	1.5		$\mu$ s
$t_r, t_f$	Input Rise and Fall Times		220	ns

## Inputs/Outputs

**CONTROL 1:** A mode switch input, which when held at a logic "1" or left floating, gates the internal oscillator onto the INT/EXT CLK pin. When  $\overline{CONTROL 1}$  is at a logic "0", the shift register can be driven externally through the INT/EXT CLK pin.

**CONTROL 2:** A mode switch input, which when held at a logic "1" or left floating, gates the last stage of the shift register onto the OUT 2/DATA IN pin. When  $\overline{CONTROL 2}$  is at a logic "0", the shift register can be loaded externally through the OUT 2/DATA IN pin.

**OUT 1:** An output pin for the sequence-limited output from the shift register.

**INT/EXT CLK:** An input/output pin. See  $\overline{CONTROL 1}$  for description.

**OUT 2/DATA IN:** An input/output pin. See  $\overline{CONTROL 2}$  for description.

## Timing Diagrams

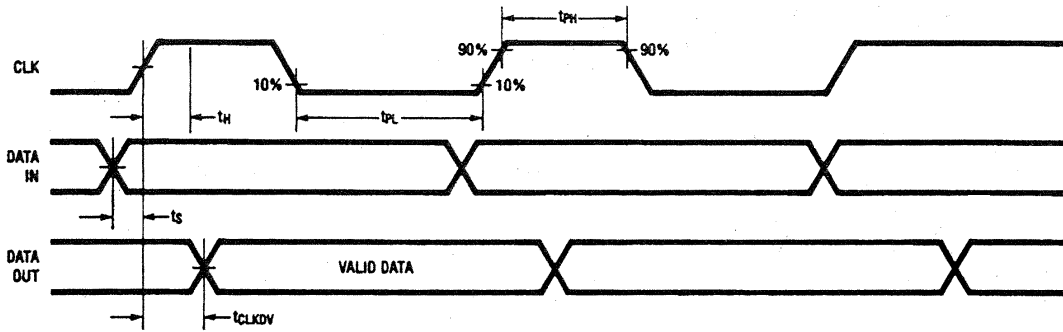

TL/F/5260-3

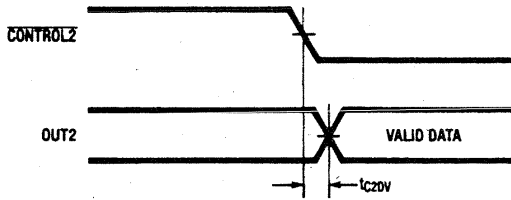

TL/F/5260-4

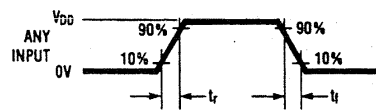

TL/F/5260-5

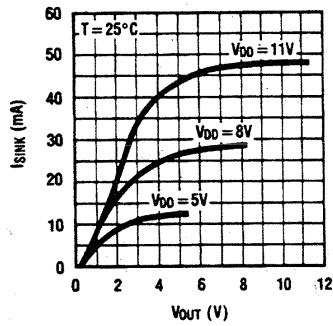

TL/F/5260-6

FIGURE 1.  $I_{SINK}$  vs  $V_{OUT}$

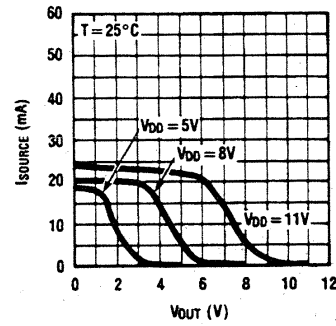

TL/F/5260-7

FIGURE 2.  $I_{SOURCE}$  vs  $V_{OUT}$

## Typical Applications

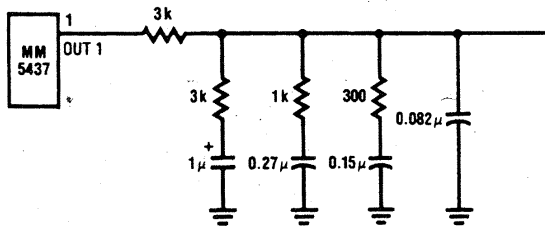

TL/F/5260-8

FIGURE 3. Pink Noise Generator

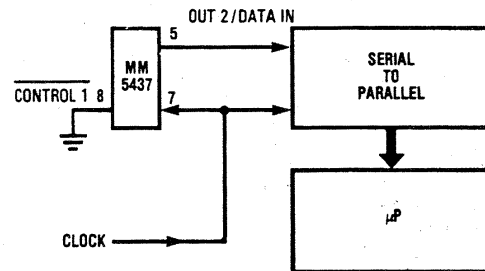

TL/F/5260-9

FIGURE 4. Pseudo-Random Number Generator