

Features

- Planar Die Construction
- 200mW Power Dissipation
- 2.4 – 51V Nominal Zener Voltage
- 5% Standard Vz Tolerance
- Designed for Surface Mount Application
- Plastic Material – UL Recognition Flammability Classification 94V-O

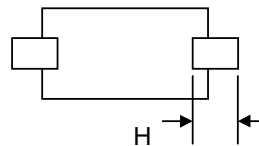
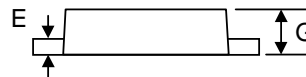
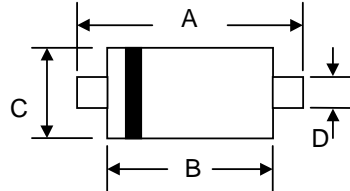

SOD-323		
Dim	Min	Max
A	2.30	2.70
B	1.75	1.95
C	1.15	1.35
D	0.25	0.35
E	0.05	0.15
G	0.70	0.95
H	0.30	—
All Dimensions in mm		

Mechanical Data

- Case: SOD-323, Molded Plastic
- Terminals: Plated Leads Solderable per MIL-STD-202, Method 208
- Polarity: Cathode Band
- Weight: 0.004 grams (approx.)
- Marking: Device Code, See Page 2
- **Lead Free: For RoHS / Lead Free Version, Add “-LF” Suffix to Part Number, See Page 5**

Maximum Ratings @ $T_A=25^\circ\text{C}$ unless otherwise specified

Characteristic	Symbol	Value	Unit
Peak Pulse Power Dissipation at $T_A = 25^\circ\text{C}$ (Note 1)	P_d	200	mW
Forward Voltage @ $I_F = 10\text{mA}$	V_F	0.9	V
Thermal Resistance Junction to Ambient (Note 1)	$R_{\theta JA}$	625	$^\circ\text{C/W}$
Operating and Storage Temperature Range	T_j, T_{STG}	-65 to +150	$^\circ\text{C}$

Note: 1. Valid provided that device terminals are kept at ambient temperature.

Electrical Characteristics @T_A=25°C unless otherwise specified

Type Number (Note 1)	Device Marking Code	Zener Voltage Range (Note 2)			Maximum Zener Impedance (Note 3)				Max Reverse Leakage Current		Temp. Coefficient of Zener Voltage @ I _{ZT} mV / °C	
		V _Z @ I _{ZT}			Z _{ZT} @ I _{ZT}		Z _{ZK} @ I _{ZK}		I _R	@ V _R	Min	Max
		Nom (V)	Min (V)	Max (V)	(Ω)	(mA)	(Ω)	(mA)	(μA)	(V)		
BZT52C2V4S	W1	2.4	2.28	2.52	85	5.0	600	1.0	100	1.0	-3.5	0
BZT52C2V7S	W2	2.7	2.57	2.84	83	5.0	600	1.0	75	1.0	-3.5	0
BZT52C3S	W3	3.0	2.85	3.15	95	5.0	600	1.0	50	1.0	-3.5	0
BZT52C3V3S	W4	3.3	3.14	3.47	95	5.0	600	1.0	25	1.0	-3.5	0
BZT52C3V6S	W5	3.6	3.42	3.78	95	5.0	600	1.0	15	1.0	-3.5	0
BZT52C3V9S	W6	3.9	3.71	4.10	95	5.0	600	1.0	10	1.0	-3.5	0
BZT52C4V3S	W7	4.3	4.09	4.52	95	5.0	600	1.0	5.0	1.0	-3.5	0
BZT52C4V7S	W8	4.7	4.47	4.94	78	5.0	500	1.0	5.0	1.0	-3.5	0.2
BZT52C5V1S	W9	5.1	4.85	5.36	60	5.0	480	1.0	0.1	0.8	-2.7	1.2
BZT52C5V6S	WA	5.6	5.32	5.88	40	5.0	400	1.0	0.1	1.0	-2.0	2.5
BZT52C6V2S	WB	6.2	5.89	6.51	10	5.0	150	1.0	0.1	2.0	0.4	3.7
BZT52C6V8S	WC	6.8	6.46	7.14	8.0	5.0	80	1.0	0.1	3.0	1.2	4.5
BZT52C7V5S	WD	7.5	7.13	7.88	7.0	5.0	80	1.0	0.1	5.0	2.5	5.3
BZT52C8V2S	WE	8.2	7.79	8.61	7.0	5.0	80	1.0	0.1	6.0	3.2	6.2
BZT52C9V1S	WF	9.1	8.65	9.56	10	5.0	100	1.0	0.1	7.0	3.8	7.0
BZT52C10S	WG	10	9.50	10.50	15	5.0	150	1.0	0.1	7.5	4.5	8.0
BZT52C11S	WH	11	10.45	11.55	20	5.0	150	1.0	0.1	8.5	5.4	9.0
BZT52C12S	WI	12	11.40	12.60	20	5.0	150	1.0	0.1	9.0	6.0	10
BZT52C13S	WK	13	12.35	13.65	25	5.0	170	1.0	0.1	10	7.0	11
BZT52C15S	WL	15	14.25	15.75	30	5.0	200	1.0	0.1	11	9.2	13
BZT52C16S	WM	16	15.20	16.80	40	5.0	200	1.0	0.1	12	10.4	14
BZT52C18S	WN	18	17.10	18.90	50	5.0	225	1.0	0.1	14	12.4	16
BZT52C20S	WO	20	19.00	21.00	50	5.0	225	1.0	0.1	15	14.4	18
BZT52C22S	WP	22	20.90	23.10	55	5.0	250	1.0	0.1	17	16.4	20
BZT52C24S	WR	24	22.80	25.20	80	5.0	250	1.0	0.1	18	18.4	22
BZT52C27S	WS	27	25.65	28.35	80	5.0	300	1.0	0.1	20	21.4	25.3
BZT52C30S	WT	30	28.50	31.50	80	5.0	300	1.0	0.1	22.5	24.4	29.4
BZT52C33S	WU	33	31.35	34.65	80	5.0	325	1.0	0.1	25	27.4	33.4
BZT52C36S	WW	36	34.20	37.80	90	5.0	350	1.0	0.1	27	30.4	37.4
BZT52C39S	WX	39	37.05	40.95	90	5.0	350	1.0	0.1	29	33.4	41.2
BZT52C43S	WY	43	40.85	45.15	100	5.0	700	1.0	0.1	32	10.0	12
BZT52C47S	WZ	47	44.65	49.35	100	5.0	750	1.0	0.1	35	10.0	12
BZT52C51S	XA	51	48.45	53.55	100	5.0	750	1.0	0.1	38	10.0	12

Note: 1. Type numbers listed have standard tolerance on the nominal zener voltage of ±5%.

2. Measured with pulses $t_p = 5\text{ms}$.

3. $f = 1\text{KHz}$

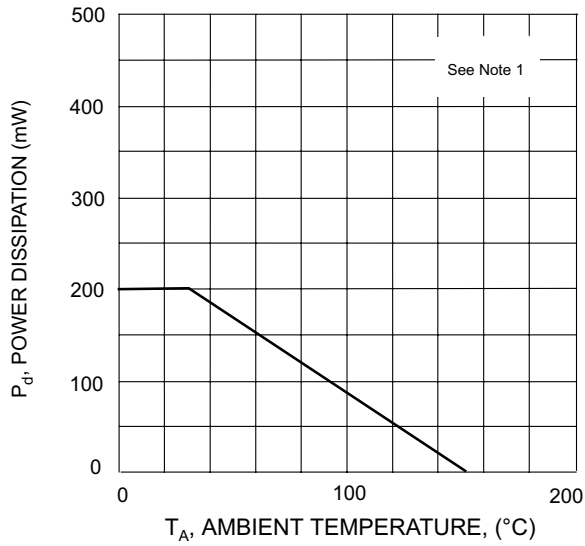

Fig. 1 Power Derating Curve

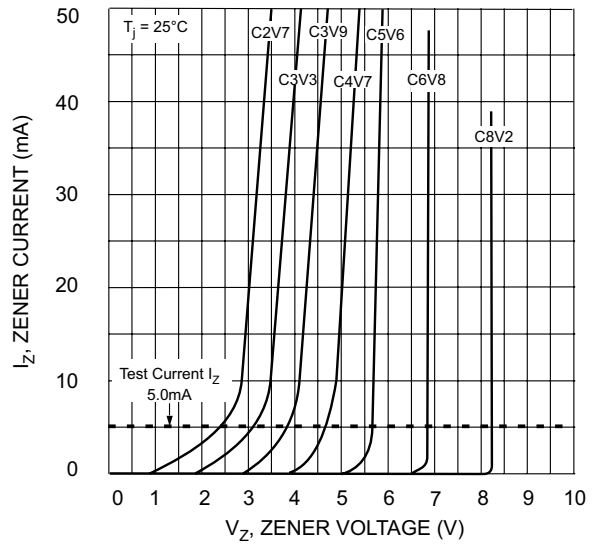

Fig. 2 Zener Breakdown Characteristics

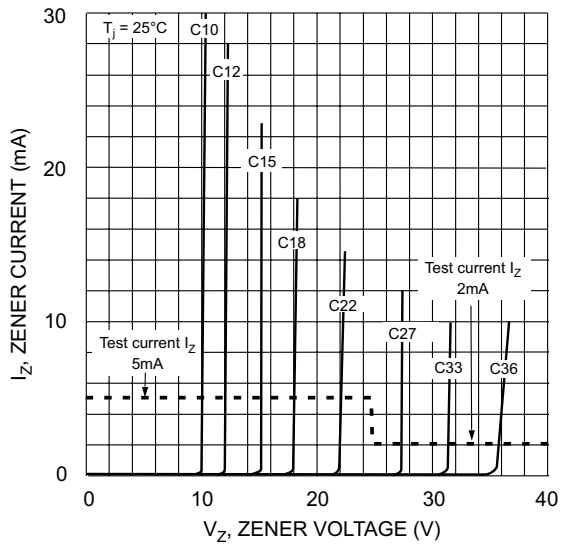

Fig. 3 Zener Breakdown Characteristics

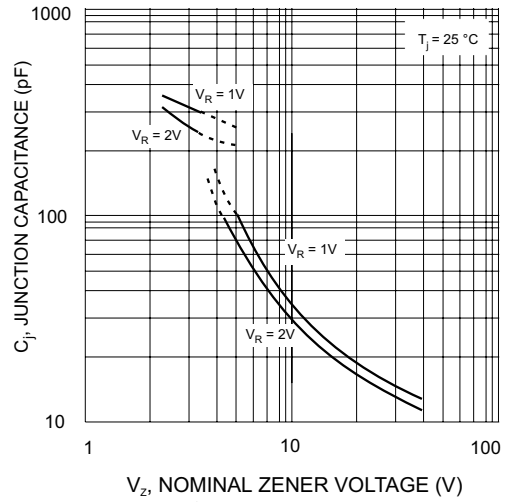

Fig. 4 Junction Capacitance vs. Nominal Zener Voltage

MARKING INFORMATION



Cathode = Polarity Band
xx = Device Code, See Page 2

RECOMMENDED FOOTPRINT

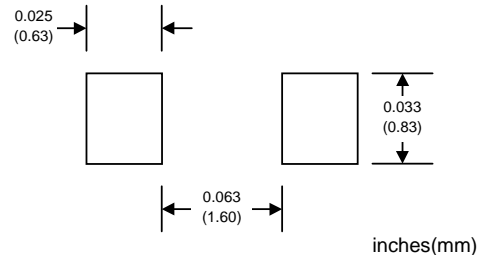

PACKAGING INFORMATION

TAPE & REEL

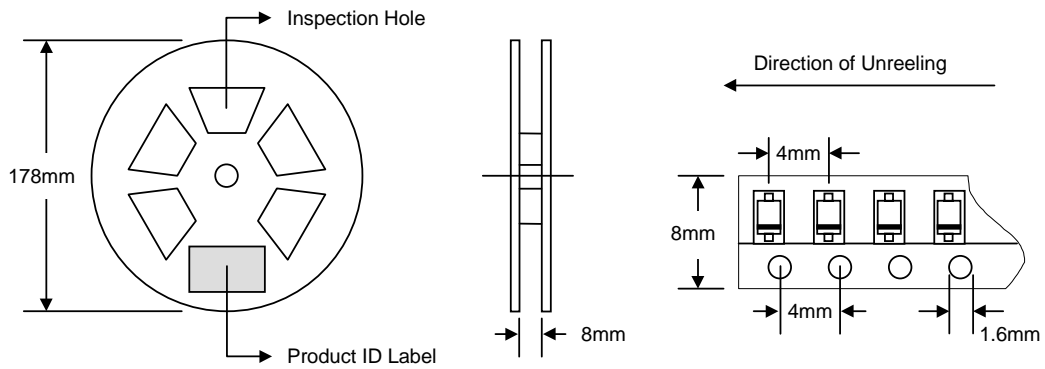

Reel Diameter (mm)	Quantity (PCS)	Inner Box Size L x W x H (mm)	Quantity (PCS)	Carton Size L x W x H (mm)	Quantity (PCS)	Approx. Gross Weight (KG)
178	5,000	187 x 187 x 65	25,000	390 x 240 x 420	250,000	10.0

Note: 1. Anti-static plastic reel, white, water clear or blue color. Inspection hole might be varied in different alignment.
2. Components are packed in accordance with EIA standard 481-1 and 481-2.

ORDERING INFORMATION

Product No.	Package Type	Shipping Quantity
BZT52CxxS-T1	SOD-323	5000/Tape & Reel

1. Shipping quantity given is for minimum packing quantity only. For minimum order quantity, please consult the Sales Department.
2. **To order RoHS / Lead Free version (with Lead Free finish), add "-LF" suffix to part number above. For example, BZT52C2V4S-T1-LF.**

Won-Top Electronics Co., Ltd (WTE) has checked all information carefully and believes it to be correct and accurate. However, WTE cannot assume any responsibility for inaccuracies. Furthermore, this information does not give the purchaser of semiconductor devices any license under patent rights to manufacturer. WTE reserves the right to change any or all information herein without further notice.

WARNING: DO NOT USE IN LIFE SUPPORT EQUIPMENT. WTE power semiconductor products are not authorized for use as critical components in life support devices or systems without the express written approval.

Won-Top Electronics Co., Ltd.
No. 44 Yu Kang North 3rd Road, Chine Chen Dist., Kaohsiung, Taiwan
Phone: 886-7-822-5408 or 886-7-822-5410
Fax: 886-7-822-5417
Email: sales@wontop.com
Internet: <http://www.wontop.com>

We power your everyday.