

Metallized Polypropylene Film Capacitors DC Capacitor MKP Type

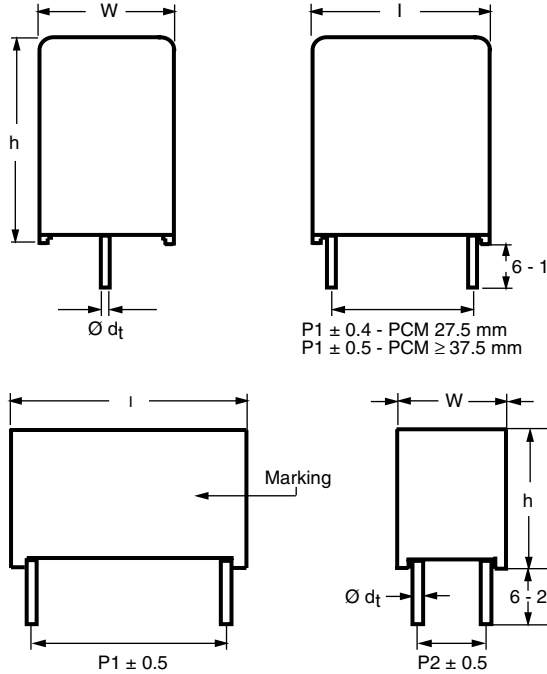

Dimensions in millimeters
 $\varnothing d_t \pm 10\%$ of standard diameter specified

APPLICATIONS

High performance DC filtering applications

REFERENCE STANDARDS

IEC 61071
 IEC 60068

MARKING

C-value; tolerance; rated voltage; code for dielectric material; code for manufacturing origin; manufacturer's type designation; manufacturer's logo; year and week of manufacture

DIELECTRIC

Polypropylene film

ELECTRODES

Metallized dielectric capacitor

CONSTRUCTION

Mono construction

ENCAPSULATION

Plastic case, sealed with resin
 Flame retardant

TERMINALS

Tinned wires

FEATURES

Lead (Pb)-free product
 RoHS compliant product



RATED CAPACITANCE

1 μ F to 400 μ F

CAPACITANCE TOLERANCE

$\pm 5\%$



RoHS
 COMPLIANT

DC VOLTAGE RATING

| | | | | | |
|--------|-------|-------|--------|--------|--------|
| 85 °C | 450 V | 700 V | 900 V | 1100 V | 1200 V |
| 70 °C | 500 V | 800 V | 1100 V | 1350 V | 1500 V |
| 105 °C | 300 V | 500 V | 650 V | 800 V | 850 V |

INSULATION RESISTANCE

RC between leads, after 1 min > 10 000 s
 For $U_{Ndc} \leq 500$ V measuring voltage 100 V
 For $U_{Ndc} > 500$ V measuring voltage 500 V

SELF INDUCTANCE (L_s)

< 1 nH per mm of lead spacing

TEST VOLTAGE BETWEEN TERMINALS

1.5 U_{Ndc} for 10 s

CLIMATIC TESTING CLASS

40/85/56

MAXIMUM APPLICATION TEMPERATURE

85 °C

MAXIMUM OPERATING TEMPERATURE (CASE)

105 °C

LIFETIME EXPECTANCY

Operation life time > 100 000 h
 FIT: < $10 \times 10^{-9}/h$ (10 per 10^9 component h) at $0.5 \times U_{Ndc}$;
 40 °C

DETAIL SPECIFICATION

For more detailed data and test requirements, contact:
dc-film@vishay.com

COMPOSITION OF CATALOG NUMBER

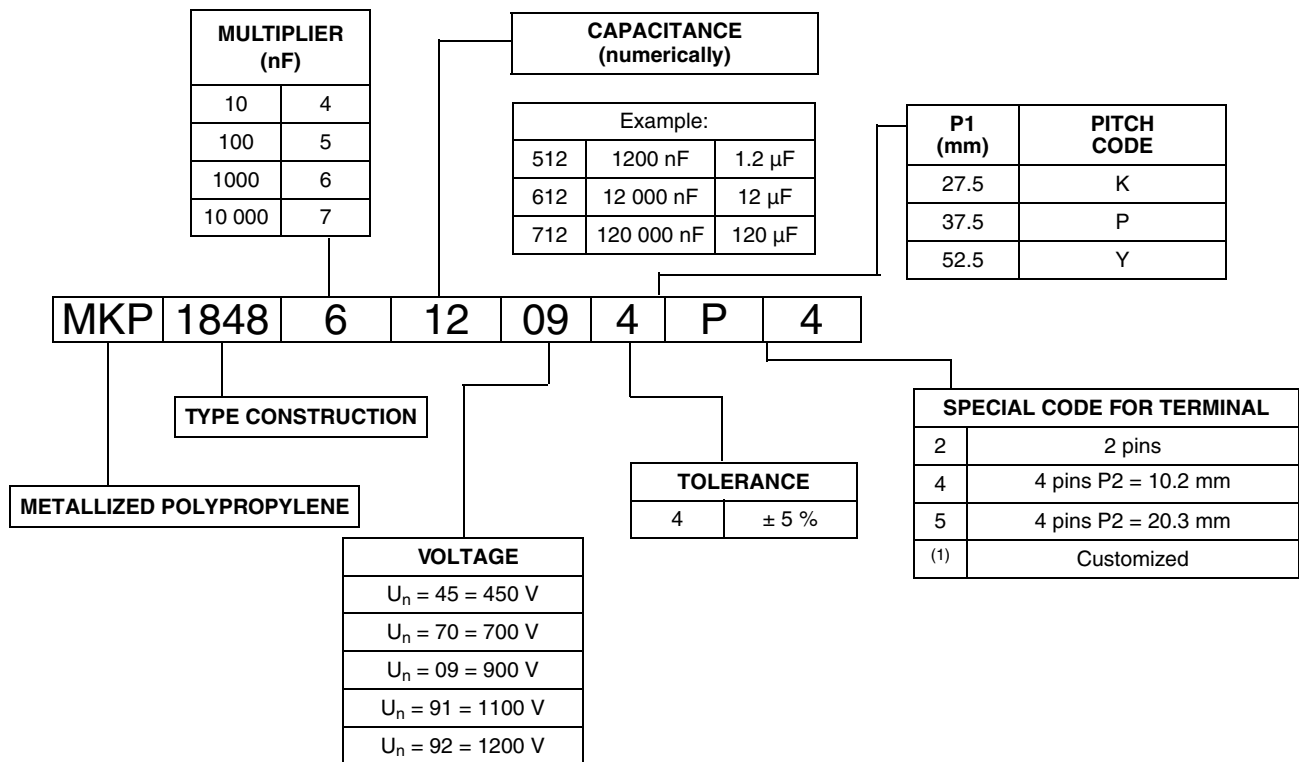

Note

(1) Tabs terminals or customized terminals are available on request

SPECIFIC REFERENCE DATA 450 Vdc

U_{Ndc} = 450 V, U_{Ndc70 °C} = 500 V, U_{Ndc105 °C} = 300 V

| CAP. (5) | DIMENSIONS (mm) (4) | | | P1 | P2 | Ø d _t | dV/dt | I _{PEAK} | I _{RMS} (A) (2) | | ESR (mΩ) (3) | | tan δ 1 kHz < (10 ⁻⁴) | | tan δ 10 kHz < (10 ⁻⁴) | | MASS (g) | SPQ (pcs) | PART NUMBER (1) |
|-------------|------------------------|------|------|------|------|------------------|-------|-------------------|-----------------------------|--------|-----------------|--------|---|--------|--|--------|-------------|--------------|-----------------|
| | W | H | L | | | | | | 2 pins | 4 pins | 2 pins | 4 pins | 2 pins | 4 pins | 2 pins | 4 pins | | | |
| 1 | 9.0 | 19.0 | 32.0 | 27.5 | - | 0.8 | 75 | 75 | 1.5 | - | 115 | - | 11.0 | - | 100 | - | 6.8 | 160 | MKP1848510454K2 |
| 2 | 9.0 | 19.0 | 32.0 | 27.5 | - | 0.8 | 75 | 150 | 2.5 | - | 57.5 | - | 11.0 | - | 100 | - | 6.0 | 160 | MKP1848520454K2 |
| 3 | 11.0 | 21.0 | 32.0 | 27.5 | - | 0.8 | 75 | 225 | 3.0 | - | 38.5 | - | 11.0 | - | 100 | - | 9.2 | 130 | MKP1848530454K2 |
| 4 | 11.0 | 21.0 | 32.0 | 27.5 | - | 0.8 | 75 | 300 | 3.5 | - | 30.0 | - | 11.0 | - | 100 | - | 8.4 | 130 | MKP1848540454K2 |
| 5 | 13.0 | 23.0 | 32.0 | 27.5 | - | 0.8 | 75 | 375 | 4.0 | - | 23.0 | - | 11.0 | - | 100 | - | 10.7 | 115 | MKP1848550454K2 |
| 6 | 15.0 | 25.0 | 32.0 | 27.5 | - | 0.8 | 75 | 450 | 4.5 | - | 19.0 | - | 11.0 | - | 100 | - | 12.5 | 100 | MKP1848560454K2 |
| 7 | 15.0 | 25.0 | 32.0 | 27.5 | - | 0.8 | 75 | 525 | 5.0 | - | 16.5 | - | 11.0 | - | 100 | - | 11.7 | 100 | MKP1848570454K2 |
| 8 | 18.0 | 28.0 | 32.0 | 27.5 | - | 0.8 | 75 | 600 | 6.0 | - | 14.0 | - | 11.0 | - | 100 | - | 17.2 | 80 | MKP1848580454K2 |
| 9 | 18.0 | 28.0 | 32.0 | 27.5 | - | 0.8 | 75 | 675 | 6.5 | - | 13.0 | - | 11.0 | - | 100 | - | 16.3 | 80 | MKP1848590454K2 |
| 10 | 18.0 | 28.0 | 32.0 | 27.5 | - | 0.8 | 75 | 750 | 7.0 | - | 11.5 | - | 11.0 | - | 100 | - | 15.4 | 80 | MKP1848610454K2 |
| 12 | 21.0 | 31.0 | 32.0 | 27.5 | - | 0.8 | 75 | 900 | 8.0 | - | 10.0 | - | 11.0 | - | 100 | - | 22.2 | 65 | MKP1848612454K2 |
| 10 | 18.5 | 35.5 | 43.0 | 37.5 | 10.2 | 1.0 | 40 | 400 | 6.0 | 6.5 | 23.0 | 20.5 | 22.0 | 20.0 | 200 | 185 | 37.5 | 105 | MKP1848610454P* |
| 12 | 18.5 | 35.5 | 43.0 | 37.5 | 10.2 | 1.0 | 40 | 480 | 7.0 | 7.5 | 19.0 | 17.0 | 22.0 | 20.0 | 200 | 185 | 36.1 | 105 | MKP1848612454P* |
| 15 | 18.5 | 35.5 | 43.0 | 37.5 | 10.2 | 1.0 | 40 | 600 | 7.5 | 8.0 | 15.0 | 13.0 | 22.0 | 20.0 | 200 | 185 | 33.9 | 105 | MKP1848615454P* |
| 20 | 21.5 | 38.5 | 43.0 | 37.5 | 10.2 | 1.0 | 40 | 800 | 9.0 | 10 | 11.5 | 13.5 | 22.0 | 20.0 | 200 | 185 | 41.6 | 91 | MKP1848620454P* |
| 22 | 21.5 | 38.5 | 43.0 | 37.5 | 10.2 | 1.0 | 40 | 880 | 9.5 | 10.0 | 10.5 | 9.5 | 22.0 | 20.0 | 200 | 185 | 40.1 | 91 | MKP1848622454P* |
| 25 | 21.5 | 38.5 | 43.0 | 37.5 | 10.2 | 1.0 | 40 | 1000 | 10.0 | 10.5 | 9.5 | 8.5 | 22.0 | 20.0 | 200 | 185 | 37.8 | 91 | MKP1848625454P* |
| 30 | 24.0 | 44.0 | 42.0 | 37.5 | 10.2 | 1.0 | 40 | 1200 | 11.0 | 12.0 | 7.5 | 8.0 | 22.0 | 20.0 | 200 | 185 | 50 | 77 | MKP1848630454P* |



Metallized Polypropylene Film Capacitors
DC Capacitor MKP Type

Vishay Roederstein

| CAP. (5) (μF) | DIMENSIONS (mm) (4) | | | P1 (mm) | P2 (mm) | Ø d _t (mm) | dV/dt (V/μs) | I _{PEAK} (A) | I _{RMS} (A) (2) | | ESR (mΩ) (3) | | tan δ 1 kHz < (10 ⁻⁴) | | tan δ 10 kHz < (10 ⁻⁴) | | MASS (g) | SPQ (pcs) | PART NUMBER (1) |
|---------------------|------------------------|------|------|------------|------------|--------------------------|-----------------|--------------------------|-----------------------------|--------|-----------------|--------|---|--------|--|--------|-------------|--------------|-----------------|
| | W | H | L | | | | | | 2 pins | 4 pins | 2 pins | 4 pins | 2 pins | 4 pins | 2 pins | 4 pins | | | |
| 35 | 30.0 | 45.0 | 42.0 | 37.5 | 10.2/20.3 | 1.0 | 40 | 1400 | 14.0 | 15.0 | 6.5 | 5.9 | 22.0 | 20.0 | 200 | 185 | 67 | 63 | MKP1848635454P* |
| 40 | 30.0 | 45.0 | 42.0 | 37.5 | 10.2/20.3 | 1.0 | 40 | 1600 | 14.5 | 15.5 | 6.0 | 5.0 | 22.0 | 20.0 | 200 | 185 | 63 | 63 | MKP1848640454P* |
| 40 | 25.0 | 45.0 | 57.5 | 52.5 | 20.3 | 1.2 | 20 | 800 | 11.0 | 12.0 | 11.5 | 10.0 | 40.0 | 36.0 | 400 | 370 | 77 | 55 | MKP1848640454Y* |
| 45 | 25.0 | 45.0 | 57.5 | 52.5 | 20.3 | 1.2 | 20 | 900 | 12.0 | 13.0 | 10.0 | 9.0 | 40.0 | 36.0 | 400 | 370 | 73 | 55 | MKP1848645454Y* |
| 50 | 30.0 | 45.0 | 57.5 | 52.5 | 20.3 | 1.2 | 20 | 1000 | 13.0 | 14.0 | 9.0 | 8.5 | 40.0 | 36.0 | 400 | 370 | 104 | 45 | MKP1848650454Y* |
| 55 | 30.0 | 45.0 | 57.5 | 52.5 | 20.3 | 1.2 | 20 | 1100 | 14.0 | 15.0 | 8.5 | 7.5 | 40.0 | 36.0 | 400 | 370 | 100 | 45 | MKP1848655454Y* |
| 60 | 30.0 | 45.0 | 57.5 | 52.5 | 20.3 | 1.2 | 20 | 1200 | 14.5 | 15.5 | 7.5 | 6.5 | 40.0 | 36.0 | 400 | 370 | 95 | 45 | MKP1848660454Y* |
| 65 | 35.0 | 50.0 | 57.5 | 52.5 | 20.3 | 1.2 | 20 | 1300 | 16.0 | 17.0 | 7.0 | 6.0 | 40.0 | 36.0 | 400 | 370 | 119 | 40 | MKP1848665454Y* |
| 70 | 35.0 | 50.0 | 57.5 | 52.5 | 20.3 | 1.2 | 20 | 1400 | 17.0 | 18.0 | 6.5 | 6.0 | 40.0 | 36.0 | 400 | 370 | 117 | 40 | MKP1848670454Y* |
| 75 | 35.0 | 50.0 | 57.5 | 52.5 | 20.3 | 1.2 | 20 | 1500 | 17.5 | 18.5 | 6.0 | 5.5 | 40.0 | 36.0 | 400 | 370 | 113 | 40 | MKP1848675454Y* |
| 80 | 35.0 | 50.0 | 57.5 | 52.5 | 20.3 | 1.2 | 20 | 1600 | 18.0 | 19.0 | 5.5 | 5.0 | 40.0 | 36.0 | 400 | 370 | 106 | 40 | MKP1848680454Y* |
| 90 | 45.0 | 45.0 | 57.5 | 52.5 | 20.3 | 1.2 | 20 | 1800 | - | 15.5 | - | 4.5 | - | 36.0 | - | 370 | 192 | 30 | MKP1848690454Y5 |
| 95 | 45.0 | 45.0 | 57.5 | 52.5 | 20.3 | 1.2 | 20 | 1900 | - | 15.5 | - | 4.0 | - | 36.0 | - | 370 | 192 | 30 | MKP1848695454Y5 |
| 100 | 45.0 | 45.0 | 57.5 | 52.5 | 20.3 | 1.2 | 20 | 2000 | - | 16.0 | - | 4.0 | - | 36.0 | - | 370 | 192 | 30 | MKP1848710454Y5 |
| 200 | 70.0 | 60.0 | 57.5 | 52.5 | 20.3 | 1.2 | 20 | 2000 | - | 38.0 | - | 2.0 | - | 36.0 | - | 370 | 451 | 20 | MKP1848720454Y5 |
| 400 | 130.0 | 60.0 | 57.5 | 52.5 | 20.3 | 1.2 | 10 | 4000 | - | 68.0 | - | 1.0 | - | 36.0 | - | 370 | 946 | 10 | MKP1848740454Y5 |

Notes

- (1) Change the * symbol with special code for the terminals
- (2) Maximum rms current at 10 kHz, + 85 °C, Cap. tol. ≤ ± 5 %
- (3) Equivalent series resistance typical values at 10 kHz
- (4) Standard dimension
- (5) Intermediate capacitance values available on request.
- SPQ = Standard Packing Quantity

SPECIFIC REFERENCE DATA 700 Vdc

U_{Ndc} = 700 V, U_{Ndc70 °C} = 800 V, U_{Ndc105 °C} = 500 V

| CAP. (5) (μF) | DIMENSIONS (mm) (4) | | | P1 (mm) | P2 (mm) | Ø d _t (mm) | dV/d _t (V/μs) | I _{PEAK} (A) | I _{RMS} (A) (2) | | ESR (mΩ) (3) | | tan δ 1 kHz < (10 ⁻⁴) | | tan δ 10 kHz < (10 ⁻⁴) | | MASS (g) | SPQ (pcs) | PART NUMBER (1) |
|---------------------|------------------------|------|------|------------|------------|--------------------------|-----------------------------|--------------------------|-----------------------------|--------|-----------------|--------|---|--------|--|--------|-------------|--------------|-----------------|
| | W | H | L | | | | | | 2 pins | 4 pins | 2 pins | 4 pins | 2 pins | 4 pins | 2 pins | 4 pins | | | |
| 1 | 9.0 | 19.0 | 32.0 | 27.5 | - | 0.8 | 65 | 65 | 1.5 | - | 94.0 | - | 10.0 | - | 85 | - | 6.6 | 160 | MKP1848510704K2 |
| 2 | 9.0 | 19.0 | 32.0 | 27.5 | - | 0.8 | 65 | 130 | 2.5 | - | 47.0 | - | 10.0 | - | 85 | - | 5.6 | 160 | MKP1848520704K2 |
| 3 | 11.0 | 21.0 | 32.0 | 27.5 | - | 0.8 | 65 | 195 | 3.0 | - | 31.5 | - | 10.0 | - | 85 | - | 8.5 | 130 | MKP1848530704K2 |
| 4 | 13.0 | 23.0 | 32.0 | 27.5 | - | 0.8 | 65 | 260 | 4.0 | - | 23.5 | - | 10.0 | - | 85 | - | 10.5 | 115 | MKP1848540704K2 |
| 5 | 15.0 | 25.0 | 32.0 | 27.5 | - | 0.8 | 65 | 325 | 4.5 | - | 19.0 | - | 10.0 | - | 85 | - | 12.1 | 100 | MKP1848550704K2 |
| 6 | 18.0 | 28.0 | 32.0 | 27.5 | - | 0.8 | 65 | 390 | 6.0 | - | 16.0 | - | 10.0 | - | 85 | - | 17.4 | 80 | MKP1848560704K2 |
| 7 | 18.0 | 28.0 | 32.0 | 27.5 | - | 0.8 | 65 | 455 | 6.5 | - | 13.5 | - | 10.0 | - | 85 | - | 16.2 | 80 | MKP1848570704K2 |
| 8 | 18.0 | 28.0 | 32.0 | 27.5 | - | 0.8 | 65 | 520 | 7.0 | - | 12.0 | - | 10.0 | - | 85 | - | 15.1 | 80 | MKP1848580704K2 |
| 9 | 21.0 | 31.0 | 32.0 | 27.5 | - | 0.8 | 65 | 585 | 7.5 | - | 10.5 | - | 10.0 | - | 85 | - | 22.5 | 65 | MKP1848590704K2 |
| 10 | 21.0 | 31.0 | 32.0 | 27.5 | - | 0.8 | 65 | 650 | 8.5 | - | 9.5 | - | 10.0 | - | 85 | - | 21.3 | 65 | MKP1848610704K2 |
| 10 | 18.5 | 35.5 | 43.0 | 37.5 | 10.2 | 1.0 | 30 | 300 | 7.0 | 7.5 | 19.5 | 17.5 | 19.0 | 17.0 | 170 | 160 | 35.5 | 105 | MKP1848610704P* |
| 12 | 18.5 | 35.5 | 43.0 | 37.5 | 10.2 | 1.0 | 30 | 360 | 7.5 | 8.0 | 16.5 | 15.0 | 19.0 | 17.0 | 170 | 160 | 33.7 | 105 | MKP1848612704P* |
| 15 | 18.5 | 35.5 | 43.0 | 37.5 | 10.2 | 1.0 | 30 | 450 | 8.0 | 9.0 | 13.0 | 11.5 | 19.0 | 17.0 | 170 | 160 | 30.8 | 105 | MKP1848615704P* |
| 20 | 21.5 | 38.5 | 43.0 | 37.5 | 10.2 | 1.0 | 30 | 600 | 10.0 | 11.0 | 10.0 | 9.0 | 19.0 | 17.0 | 170 | 160 | 37.3 | 91 | MKP1848620704P* |
| 22 | 24.0 | 44.0 | 42.0 | 37.5 | 10.2 | 1.0 | 30 | 660 | 11.0 | 12.0 | 9.0 | 8.0 | 19.0 | 17.0 | 170 | 160 | 51 | 77 | MKP1848622704P* |
| 25 | 24.0 | 44.0 | 42.0 | 37.5 | 10.2 | 1.0 | 30 | 750 | 12.0 | 13.0 | 8.0 | 7.0 | 19.0 | 17.0 | 170 | 160 | 48 | 77 | MKP1848625704P* |
| 30 | 30.0 | 45.0 | 42.0 | 37.5 | 10.2/20.3 | 1.0 | 30 | 900 | 14.0 | 14.5 | 6.5 | 6.0 | 19.0 | 17.0 | 170 | 160 | 64 | 63 | MKP1848630704P* |
| 35 | 30.0 | 45.0 | 42.0 | 37.5 | 10.2/20.3 | 1.0 | 30 | 1050 | 15.0 | 15.5 | 5.5 | 5.0 | 19.0 | 17.0 | 170 | 160 | 58 | 63 | MKP1848635704P* |
| 30 | 25.0 | 45.0 | 57.5 | 52.5 | 20.3 | 1.2 | 15 | 450 | 10.5 | 11.5 | 13.0 | 11.5 | 35.0 | 33.0 | 350 | 320 | 78 | 55 | MKP1848630704Y* |
| 35 | 25.0 | 45.0 | 57.5 | 52.5 | 20.3 | 1.2 | 15 | 525 | 11.5 | 12.0 | 11.0 | 10.0 | 35.0 | 33.0 | 350 | 320 | 73 | 55 | MKP1848635704Y* |
| 40 | 25.0 | 45.0 | 57.5 | 52.5 | 20.3 | 1.2 | 15 | 600 | 12.0 | 12.5 | 10.0 | 9.0 | 35.0 | 33.0 | 350 | 320 | 68 | 55 | MKP1848640704Y* |

MKP 1848 DC-Link



Vishay Roederstein Metallized Polypropylene Film Capacitors
DC Capacitor MKP Type

| CAP. (5) (μF) | DIMENSIONS (mm) (4) | | | P1 (mm) | P2 (mm) | $\varnothing d_t$ (mm) | dV/dt (V/ μs) | I _{PEAK} (A) | I _{RMS} (A) (2) | | ESR (m Ω) (3) | | tan δ 1 kHz < (10 ⁻⁴) | | tan δ 10 kHz < (10 ⁻⁴) | | MASS (g) | SPQ (pcs) | PART NUMBER (1) |
|----------------------------------|------------------------|------|------|------------|------------|---------------------------|------------------------------|--------------------------|-----------------------------|--------|--------------------------|--------|--|--------|---|--------|-------------|--------------|-----------------|
| | | | | | | | | | 2 pins | 4 pins | 2 pins | 4 pins | 2 pins | 4 pins | 2 pins | 4 pins | | | |
| 45 | 30.0 | 45.0 | 57.5 | 52.5 | 20.3 | 1.2 | 15 | 675 | 13.5 | 14.5 | 9.0 | 7.5 | 35.0 | 33.0 | 350 | 320 | 99 | 45 | MKP1848645704Y* |
| 50 | 30.0 | 45.0 | 57.5 | 52.5 | 20.3 | 1.2 | 15 | 750 | 14.5 | 15.5 | 8.0 | 7.0 | 35.0 | 33.0 | 350 | 320 | 92 | 45 | MKP1848650704Y* |
| 55 | 35.0 | 50.0 | 57.5 | 52.5 | 20.3 | 1.2 | 15 | 825 | 16.0 | 17.0 | 7.0 | 6.5 | 35.0 | 33.0 | 350 | 320 | 117 | 40 | MKP1848655704Y* |
| 60 | 35.0 | 50.0 | 57.5 | 52.5 | 20.3 | 1.2 | 15 | 900 | 17.0 | 18.0 | 6.5 | 6.0 | 35.0 | 33.0 | 350 | 320 | 112 | 40 | MKP1848660704Y* |
| 65 | 35.0 | 50.0 | 57.5 | 52.5 | 20.3 | 1.2 | 15 | 975 | 17.5 | 18.5 | 6.0 | 5.5 | 35.0 | 33.0 | 350 | 320 | 104 | 40 | MKP1848665704Y* |
| 70 | 45.0 | 45.0 | 57.5 | 52.5 | 20.3 | 1.2 | 15 | 1050 | - | 20.0 | - | 5.0 | - | 33.0 | - | 320 | 192 | 30 | MKP1848670704Y5 |
| 75 | 45.0 | 45.0 | 57.5 | 52.5 | 20.3 | 1.2 | 15 | 1125 | - | 21.0 | - | 4.5 | - | 33.0 | - | 320 | 192 | 30 | MKP1848675704Y5 |
| 80 | 45.0 | 45.0 | 57.5 | 52.5 | 20.3 | 1.2 | 15 | 1200 | - | 21.5 | - | 4.5 | - | 33.0 | - | 320 | 192 | 30 | MKP1848680704Y5 |
| 160 | 70.0 | 60.0 | 57.5 | 52.5 | 20.3 | 1.2 | 15 | 2400 | - | 38.0 | - | 2.2 | - | 33.0 | - | 320 | 451 | 20 | MKP1848716704Y5 |
| 320 | 130.0 | 60.0 | 57.5 | 52.5 | 20.3 | 1.2 | 15 | 4800 | - | 65.0 | - | 1.0 | - | 33.0 | - | 320 | 821 | 10 | MKP1848732704Y5 |

Notes

- (1) Change the * symbol with special code for the terminals
 - (2) Maximum rms current at 10 kHz, + 85 °C, Cap. tol. $\leq \pm 5\%$
 - (3) Equivalent series resistance typical values at 10 kHz
 - (4) Standard dimension
 - (5) Intermediate capacitance values are available on request.
- SPQ = Standard Packing Quantity

SPECIFIC REFERENCE DATA 900 Vdc

U_{Ndc} = 900 V, U_{Ndc70 °C} = 1100 V, U_{Ndc105 °C} = 650 V

| CAP. (5) (μF) | DIMENSIONS (mm) (4) | | | P1 (mm) | P2 (mm) | $\varnothing d_t$ (mm) | dV/dt (V/ μs) | I _{PEAK} (A) | I _{RMS} (A) (2) | | ESR (m Ω) (3) | | tan δ 1 kHz < (10 ⁻⁴) | | tan δ 10 kHz < (10 ⁻⁴) | | MASS (g) | SPQ (pcs) | PART NUMBER (1) |
|----------------------------------|------------------------|------|------|------------|------------|---------------------------|------------------------------|--------------------------|-----------------------------|--------|--------------------------|--------|--|--------|---|--------|-------------|--------------|-----------------|
| | | | | | | | | | 2 pins | 4 pins | 2 pins | 4 pins | 2 pins | 4 pins | 2 pins | 4 pins | | | |
| 1.0 | 9.0 | 19.0 | 32.0 | 27.5 | - | 0.8 | 80 | 80 | 2.0 | - | 88.0 | - | 8.0 | - | 65 | - | 5.9 | 160 | MKP1848510094K2 |
| 2.0 | 13.0 | 23.0 | 32.0 | 27.5 | - | 0.8 | 80 | 160 | 2.5 | - | 44.0 | - | 8.0 | - | 65 | - | 11.3 | 115 | MKP1848520094K2 |
| 3.0 | 15.0 | 25.0 | 32.0 | 27.5 | - | 0.8 | 80 | 240 | 3.5 | - | 29.5 | - | 8.0 | - | 65 | - | 12.1 | 100 | MKP1848530094K2 |
| 4.0 | 18.0 | 28.0 | 32.0 | 27.5 | - | 0.8 | 80 | 320 | 4.0 | - | 22.0 | - | 8.0 | - | 65 | - | 16.7 | 80 | MKP1848540094K2 |
| 5.0 | 21.0 | 31.0 | 32.0 | 27.5 | - | 0.8 | 80 | 400 | 5.0 | - | 18.0 | - | 8.0 | - | 65 | - | 23.3 | 65 | MKP1848550094K2 |
| 6.0 | 21.0 | 31.0 | 32.0 | 27.5 | - | 0.8 | 80 | 480 | 5.5 | - | 15.0 | - | 8.0 | - | 65 | - | 21.4 | 65 | MKP1848560094K2 |
| 5.0 | 18.5 | 35.5 | 43.0 | 37.5 | 10.2 | 1.0 | 40 | 200 | 4.0 | 4.5 | 36.5 | 32.0 | 15.0 | 13 | 140 | 125 | 37.1 | 105 | MKP1848550094P* |
| 6.0 | 18.5 | 35.5 | 43.0 | 37.5 | 10.2 | 1.0 | 40 | 240 | 4.5 | 5.0 | 30.0 | 27.0 | 15.0 | 13 | 140 | 125 | 35.6 | 105 | MKP1848560094P* |
| 7.0 | 18.5 | 35.5 | 43.0 | 37.5 | 10.2 | 1.0 | 40 | 280 | 5.0 | 5.5 | 26.0 | 23.5 | 15.0 | 13 | 140 | 125 | 34.1 | 105 | MKP1848570094P* |
| 8.0 | 18.5 | 35.5 | 43.0 | 37.5 | 10.2 | 1.0 | 40 | 320 | 5.0 | 5.5 | 22.5 | 20.5 | 15.0 | 13 | 140 | 125 | 32.5 | 105 | MKP1848580094P* |
| 9.0 | 18.5 | 35.5 | 43.0 | 37.5 | 10.2 | 1.0 | 40 | 360 | 5.5 | 6.0 | 20.0 | 18.5 | 15.0 | 13 | 140 | 125 | 30.9 | 105 | MKP1848590094P* |
| 10.0 | 21.5 | 38.5 | 43.0 | 37.5 | 10.2 | 1.0 | 40 | 400 | 6.0 | 6.5 | 18.5 | 16.5 | 15.0 | 13 | 140 | 125 | 40.7 | 91 | MKP1848610094P* |
| 12.0 | 21.5 | 38.5 | 43.0 | 37.5 | 10.2 | 1.0 | 40 | 480 | 6.5 | 7.0 | 15.0 | 13.5 | 15.0 | 13 | 140 | 125 | 37.5 | 91 | MKP1848612094P* |
| 15.0 | 24.0 | 44.0 | 42.0 | 37.5 | 10.2 | 1.0 | 40 | 600 | 8.0 | 8.5 | 12.5 | 11.0 | 15.0 | 13 | 140 | 125 | 48.9 | 77 | MKP1848615094P* |
| 16.0 | 24.0 | 44.0 | 42.0 | 37.5 | 10.2 | 1.0 | 40 | 640 | 8.0 | 8.5 | 11.5 | 10.5 | 15.0 | 13 | 140 | 125 | 47.2 | 77 | MKP1848616094P* |
| 20.0 | 30.0 | 45.0 | 42.0 | 37.5 | 10.2/20.3 | 1.0 | 40 | 800 | 9.5 | 10.0 | 9.5 | 8.5 | 15.0 | 13 | 140 | 125 | 60 | 63 | MKP1848620094P* |
| 15.0 | 25.0 | 45.0 | 57.5 | 52.5 | 20.3 | 1.2 | 20 | 300 | 6.5 | 7.5 | 24.5 | 22.0 | 30.0 | 25 | 275 | 250 | 83 | 55 | MKP1848615094Y* |
| 20.0 | 25.0 | 45.0 | 57.5 | 52.5 | 20.3 | 1.2 | 20 | 400 | 7.0 | 8.0 | 18.5 | 16.5 | 30.0 | 25 | 275 | 250 | 75 | 55 | MKP1848620094Y* |
| 22.0 | 25.0 | 45.0 | 57.5 | 52.5 | 20.3 | 1.2 | 20 | 440 | 7.5 | 8.5 | 16.5 | 15.0 | 30.0 | 25 | 275 | 250 | 72 | 55 | MKP1848622094Y* |
| 25.0 | 30.0 | 45.0 | 57.5 | 52.5 | 20.3 | 1.2 | 20 | 500 | 8.5 | 9.5 | 14.5 | 13.5 | 30.0 | 25 | 275 | 250 | 102 | 45 | MKP1848625094Y* |
| 30.0 | 30.0 | 45.0 | 57.5 | 52.5 | 20.3 | 1.2 | 20 | 600 | 9.5 | 10.5 | 12.5 | 11.0 | 30.0 | 25 | 275 | 250 | 92 | 45 | MKP1848630094Y* |
| 35.0 | 35.0 | 50.0 | 57.5 | 52.5 | 20.3 | 1.2 | 20 | 700 | 10.5 | 11.5 | 10.5 | 9.5 | 30.0 | 25 | 275 | 250 | 114 | 40 | MKP1848635094Y* |
| 40.0 | 35.0 | 50.0 | 57.5 | 52.5 | 20.3 | 1.2 | 20 | 800 | 12.0 | 13.0 | 9.5 | 8.5 | 30.0 | 25 | 275 | 250 | 103 | 40 | MKP1848640094Y* |
| 45.0 | 45.0 | 45.0 | 57.5 | 52.5 | 20.3 | 1.2 | 20 | 900 | - | 14.0 | - | 7.5 | - | 25 | - | 250 | 192 | 30 | MKP1848645094Y5 |
| 50.0 | 45.0 | 45.0 | 57.5 | 52.5 | 20.3 | 1.2 | 20 | 1000 | - | 14.5 | - | 6.5 | - | 25 | - | 250 | 191 | 30 | MKP1848650094Y5 |
| 100.0 | 70.0 | 60.0 | 57.5 | 52.5 | 20.3 | 1.2 | 20 | 2000 | - | 25.0 | - | 3.5 | - | 25 | - | 250 | 452 | 20 | MKP1848710094Y5 |

Notes

- (1) Change the * symbol with special code for the terminals
 - (2) Maximum rms current at 10 kHz, + 85 °C, Cap. tol. $\leq \pm 5\%$
 - (3) Equivalent series resistance typical values at 10 kHz
 - (4) Standard dimension
 - (5) Intermediate capacitance values are available on request.
- SPQ = Standard Packing Quantity



Metallized Polypropylene Film Capacitors
DC Capacitor MKP Type

Vishay Roederstein

SPECIFIC REFERENCE DATA 1100 Vdc

$U_{Ndc} = 1100\text{ V}$, $U_{Ndc70^\circ\text{C}} = 1350\text{ V}$, $U_{Ndc105^\circ\text{C}} = 800\text{ V}$

| CAP. (5) | DIMENSIONS (mm) (4) | | | P1 | P2 | Ø d _t | dV/d _t | I _{PEAK} | I _{RMS} (A) (2) | | ESR (mΩ) (3) | | tan δ 1 kHz < (10 ⁻⁴) | | tan δ 10 kHz < (10 ⁻⁴) | | MASS (g) | SPQ (pcs) | PART NUMBER (1) |
|-------------|------------------------|------|------|------|-------------|------------------|-------------------|-------------------|-----------------------------|------|-----------------|------|---|------|--|--------|-------------|--------------|-----------------|
| | (µF) | W | H | | | | | | L | (mm) | (mm) | (mm) | (V/µs) | (A) | 2 pins | 4 pins | | | |
| 1 | 11.0 | 21.0 | 32.0 | 27.5 | - | 0.8 | 95 | 95 | 2.5 | - | 62.0 | - | 7.0 | - | 55 | - | 9.1 | 130 | MKP1848510914K2 |
| 2 | 15.0 | 25.0 | 32.0 | 27.5 | - | 0.8 | 95 | 190 | 3.5 | - | 31.0 | - | 7.0 | - | 55 | - | 12.3 | 100 | MKP1848520914K2 |
| 3 | 18.0 | 28.0 | 32.0 | 27.5 | - | 0.8 | 95 | 285 | 5.0 | - | 21.0 | - | 7.0 | - | 55 | - | 16.0 | 80 | MKP1848530914K2 |
| 4 | 21.0 | 31.0 | 32.0 | 27.5 | - | 0.8 | 95 | 380 | 6.5 | - | 15.5 | - | 7.0 | - | 55 | - | 21.8 | 65 | MKP1848540914K2 |
| 5 | 18.5 | 35.5 | 43.0 | 37.5 | 10.2 | 1.0 | 45 | 225 | 5.5 | 6.0 | 25.5 | 23.0 | 13.0 | 12.0 | 115 | 105 | 33.7 | 105 | MKP1848550914P* |
| 6 | 18.5 | 35.5 | 43.0 | 37.5 | 10.2 | 1.0 | 45 | 270 | 6.0 | 6.5 | 21.5 | 19.0 | 13.0 | 12.0 | 115 | 105 | 31.4 | 105 | MKP1848560914P* |
| 7 | 21.5 | 38.5 | 43.0 | 37.5 | 10.2 | 1.0 | 45 | 315 | 7.0 | 7.5 | 18.5 | 16.5 | 13.0 | 12.0 | 115 | 105 | 40.5 | 91 | MKP1848570914P* |
| 8 | 21.5 | 38.5 | 43.0 | 37.5 | 10.2 | 1.0 | 45 | 360 | 4.5 | 5.0 | 16.0 | 14.5 | 13.0 | 12.0 | 115 | 105 | 38.2 | 91 | MKP1848580914P* |
| 9 | 24.0 | 44.0 | 42.0 | 37.5 | 10.2 | 1.0 | 45 | 405 | 8.5 | 9.0 | 14.0 | 13.0 | 13.0 | 12.0 | 115 | 105 | 52 | 77 | MKP1848590914P* |
| 10 | 24.0 | 44.0 | 42.0 | 37.5 | 10.2 | 1.0 | 45 | 450 | 9.0 | 9.5 | 13.0 | 11.5 | 13.0 | 12.0 | 115 | 105 | 49 | 77 | MKP1848610914P* |
| 12 | 30.0 | 45.0 | 42.0 | 37.5 | 10.2 / 20.3 | 1.0 | 45 | 540 | 10.5 | 11.0 | 10.5 | 9.5 | 13.0 | 12.0 | 115 | 105 | 66 | 63 | MKP1848612914P* |
| 10 | 25.0 | 45.0 | 57.5 | 52.5 | 20.3 | 1.2 | 23 | 230 | 7.5 | 8.5 | 25.5 | 23.0 | 25.0 | 22.0 | 230 | 210 | 84 | 55 | MKP1848610914Y* |
| 12 | 25.0 | 45.0 | 57.5 | 52.5 | 20.3 | 1.2 | 23 | 276 | 8.0 | 9.0 | 21.5 | 19.5 | 25.0 | 22.0 | 230 | 210 | 80 | 55 | MKP1848612914Y* |
| 15 | 25.0 | 45.0 | 57.5 | 52.5 | 20.3 | 1.2 | 23 | 345 | 9.0 | 10.0 | 17.0 | 15.5 | 25.0 | 22.0 | 230 | 210 | 73 | 55 | MKP1848615914Y* |
| 20 | 30.0 | 45.0 | 57.5 | 52.5 | 20.3 | 1.2 | 23 | 460 | 11.0 | 12.0 | 12.5 | 11.5 | 25.0 | 22.0 | 230 | 210 | 94 | 45 | MKP1848620914Y* |
| 22 | 35.0 | 50.0 | 57.5 | 52.5 | 20.3 | 1.2 | 23 | 506 | 12.5 | 13.5 | 11.5 | 10.5 | 25.0 | 22.0 | 230 | 210 | 119 | 40 | MKP1848622914Y* |
| 25 | 35.0 | 50.0 | 57.5 | 52.5 | 20.3 | 1.2 | 23 | 575 | 13.5 | 14.5 | 10.5 | 9.0 | 25.0 | 22.0 | 230 | 210 | 112 | 40 | MKP1848625914Y* |
| 30 | 45.0 | 45.0 | 57.5 | 52.5 | 20.3 | 1.2 | 23 | 720 | - | 16.5 | - | 7.5 | - | 22.0 | - | 210 | 192 | 30 | MKP1848630914Y5 |
| 60 | 70.0 | 60.0 | 57.5 | 52.5 | 20.3 | 1.2 | 23 | 1500 | - | 30.0 | - | 3.5 | - | 22.0 | - | 210 | 452 | 20 | MKP1848660914Y5 |

Notes

- (1) Change the * symbol with special code for the terminals
- (2) Maximum rms current at 10 kHz, + 85 °C, Cap. tol. ≤ ± 5 %
- (3) Equivalent series resistance typical values at 10 kHz
- (4) Standard dimension
- (5) Intermediate capacitance values are available on request.
- SPQ = Standard Packing Quantity

SPECIFIC REFERENCE DATA 1200 Vdc

$U_{Ndc} = 1200\text{ V}$, $U_{Ndc70^\circ\text{C}} = 1500\text{ V}$, $U_{Ndc105^\circ\text{C}} = 850\text{ V}$

| CAP. (5) | DIMENSIONS (mm) (4) | | | P1 | P2 | Ø d _t | dV/d _t | I _{PEAK} | I _{RMS} (A) (2) | | ESR (mΩ) (3) | | tan δ 1 kHz < (10 ⁻⁴) | | tan δ 10 kHz < (10 ⁻⁴) | | MASS (g) | SPQ (pcs) | PART NUMBER (1) |
|-------------|------------------------|------|------|------|-------------|------------------|-------------------|-------------------|-----------------------------|------|-----------------|------|---|------|--|--------|-------------|--------------|-----------------|
| | (µF) | W | H | | | | | | L | (mm) | (mm) | (mm) | (V/µs) | (A) | 2 pins | 4 pins | | | |
| 1 | 11.0 | 21.0 | 32.0 | 27.5 | - | 0.8 | 100 | 100 | 2.5 | - | 60.0 | - | 6.0 | - | 54 | - | 8.8 | 130 | MKP1848510924K2 |
| 2 | 15.0 | 25.0 | 32.0 | 27.5 | - | 0.8 | 100 | 200 | 4.0 | - | 30.0 | - | 6.0 | - | 54 | - | 11.7 | 100 | MKP1848520924K2 |
| 3 | 18.0 | 28.0 | 32.0 | 27.5 | - | 0.8 | 100 | 300 | 5.0 | - | 20.0 | - | 6.0 | - | 54 | - | 15.2 | 80 | MKP1848530924K2 |
| 4 | 21.0 | 31.0 | 32.0 | 27.5 | - | 0.8 | 100 | 400 | 6.5 | - | 15.0 | - | 6.0 | - | 54 | - | 20.6 | 65 | MKP1848540924K2 |
| 5 | 18.5 | 35.5 | 43.0 | 37.5 | 10.2 | 1.0 | 48 | 240 | 6.0 | 6.5 | 24.5 | 22.0 | 12.0 | 11.0 | 110 | 100 | 32.5 | 105 | MKP1848550924P* |
| 6 | 18.5 | 35.5 | 43.0 | 37.5 | 10.2 | 1.0 | 48 | 288 | 6.5 | 7.0 | 20.0 | 18.5 | 12.0 | 11.0 | 110 | 100 | 30.0 | 105 | MKP1848560924P* |
| 7 | 21.5 | 38.5 | 43.0 | 37.5 | 10.2 | 1.0 | 48 | 336 | 7.5 | 8.0 | 17.5 | 15.5 | 12.0 | 11.0 | 110 | 100 | 38.9 | 91 | MKP1848570924P* |
| 8 | 21.5 | 38.5 | 43.0 | 37.5 | 10.2 | 1.0 | 48 | 384 | 8.0 | 8.5 | 15.5 | 14.0 | 12.0 | 11.0 | 110 | 100 | 36.3 | 91 | MKP1848580924P* |
| 9 | 24.0 | 44.0 | 42.0 | 37.5 | 10.2 | 1.0 | 48 | 432 | 9.0 | 9.5 | 13.5 | 12.5 | 12.0 | 11.0 | 110 | 100 | 50 | 77 | MKP1848590924P* |
| 10 | 24.0 | 44.0 | 42.0 | 37.5 | 10.2 | 1.0 | 48 | 480 | 9.5 | 10.0 | 12.5 | 11.0 | 12.0 | 11.0 | 110 | 100 | 47 | 77 | MKP1848610924P* |
| 12 | 30.0 | 45.0 | 42.0 | 37.5 | 10.2 / 20.3 | 1.0 | 48 | 576 | 11.0 | 11.5 | 10.0 | 9.0 | 12.0 | 11.0 | 110 | 100 | 63 | 63 | MKP1848612924P* |
| 10 | 25.0 | 45.0 | 57.5 | 52.5 | 20.3 | 1.2 | 24 | 240 | 7.5 | 8.5 | 24.5 | 21.5 | 23.0 | 21.0 | 220 | 200 | 82 | 55 | MKP1848610924Y* |
| 12 | 25.0 | 45.0 | 57.5 | 52.5 | 20.3 | 1.2 | 24 | 288 | 8.5 | 9.5 | 20.5 | 18.5 | 23.0 | 21.0 | 220 | 200 | 77 | 55 | MKP1848612924Y* |

| CAP. (5) | DIMENSIONS (mm) (4) | | | P1 | P2 | Ø d _t | dV/d _t | I _{PEAK} | I _{RMS} (A) | | ESR (mΩ) (3) | | tan δ 1 kHz < (10 ⁻⁴) | | tan δ 10 kHz < (10 ⁻⁴) | | MASS (g) | SPQ (pcs) | PART NUMBER (1) |
|-------------|------------------------|------|------|------|------|------------------|-------------------|-------------------|----------------------|------|-----------------|------|---|------|--|--------|-------------|--------------|-----------------|
| | (µF) | W | H | | | | | | L | (mm) | (mm) | (mm) | (V/µs) | (A) | 2 pins | 4 pins | | | |
| 15 | 25.0 | 45.0 | 57.5 | 52.5 | 20.3 | 1.2 | 24 | 360 | 9.5 | 10.5 | 16.5 | 14.5 | 23.0 | 21.0 | 220 | 200 | 69 | 55 | MKP1848615924Y* |
| 20 | 35.0 | 50.0 | 57.5 | 52.5 | 20.3 | 1.2 | 24 | 480 | 12.5 | 13.5 | 12.5 | 11.0 | 23.0 | 21.0 | 220 | 200 | 119 | 40 | MKP1848620924Y* |
| 22 | 35.0 | 50.0 | 57.5 | 52.5 | 20.3 | 1.2 | 24 | 528 | 13.0 | 14.0 | 11.0 | 10.0 | 23.0 | 21.0 | 220 | 200 | 114 | 40 | MKP1848622924Y* |
| 25 | 35.0 | 50.0 | 57.5 | 52.5 | 20.3 | 1.2 | 24 | 600 | 14.0 | 15.0 | 10.0 | 9.0 | 23.0 | 21.0 | 220 | 200 | 104 | 40 | MKP1848625924Y* |
| 30 | 45.0 | 45.0 | 57.5 | 52.5 | 20.3 | 1.2 | 24 | 750 | - | 17.0 | - | 7.0 | - | 21.0 | - | 200 | 191 | 30 | MKP1848630924Y5 |
| 60 | 70.0 | 60.0 | 57.5 | 52.5 | 20.3 | 1.2 | 24 | 1560 | - | 28.5 | - | 3.5 | - | 21.0 | - | 200 | 450 | 15 | MKP1848660924Y5 |

Notes

- (1) Change the * symbol with special code for the terminals
- (2) Maximum rms current at 10 kHz, + 85 °C, Cap. tol. ≤ ± 5 %
- (3) Equivalent series resistance typical values at 10 kHz
- (4) Standard dimension
- (5) Intermediate capacitance values are available on request.
- SPQ = Standard Packing Quantity

CONSTRUCTION

Description

Low inductive wound cell elements of metallised polypropylene film, potted with resin in a flame retardant case.

MOUNTING

The capacitors unit is designed for mounting on PCB. The capacitors shall be mechanically fixed by the leads and body must be clamped to withstand vibration and shock.

Space Requirements on Printed-Circuit Board

The maximum length and width of film capacitors is shown in the figure:

- Eccentricity as in figure. The maximum eccentricity is smaller than or equal to the lead diameter of the product concerned
- Product height with seating plane as given by "IEC 60717" as reference: $h_{max.} \leq h + 0.5 \text{ mm}$

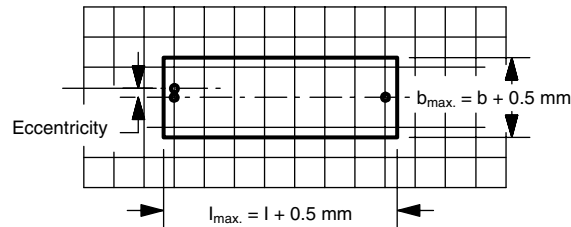

Storage temperature

- Storage temperature: $T_{stg} = - 25 \text{ °C}$ to $+ 40 \text{ °C}$ with RH maximum 80 % without condensation

Ratings and Characteristics Reference Conditions

Unless otherwise specified, all electrical values apply to an ambient free temperature of $23 \text{ °C} \pm 1 \text{ °C}$, an atmospheric pressure of 86 kPa to 106 kPa and a relative humidity of $50 \text{ \%} \pm 2 \text{ \%}$.

For reference testing, a conditioning period shall be applied over $96 \text{ h} \pm 4 \text{ h}$ by heating the products in a circulating air oven at the rated temperature and a relative humidity not exceeding 20 %.



CHARACTERISTICS

Capacitance (typical curve)

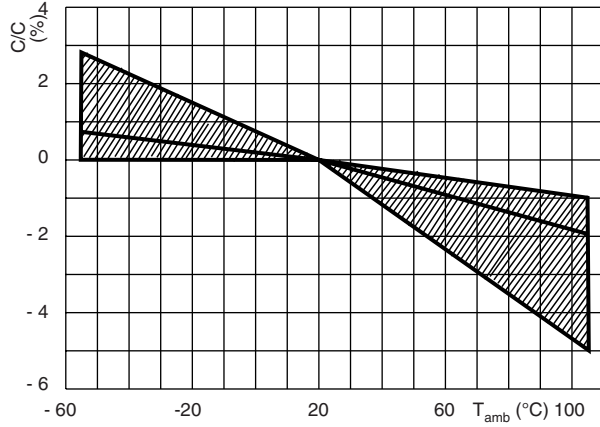

Insulation resistance (typical curve)

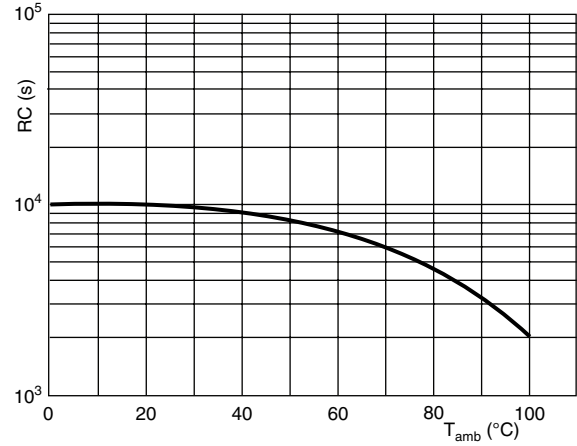

Lifetime expectancy (typical curve)

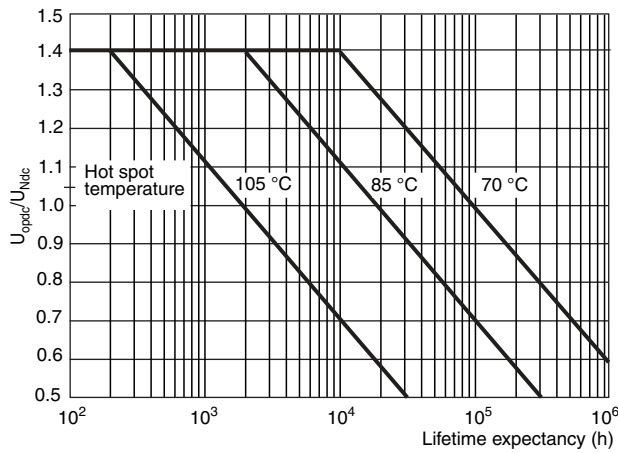

Impedance vs. frequency (typical curve)

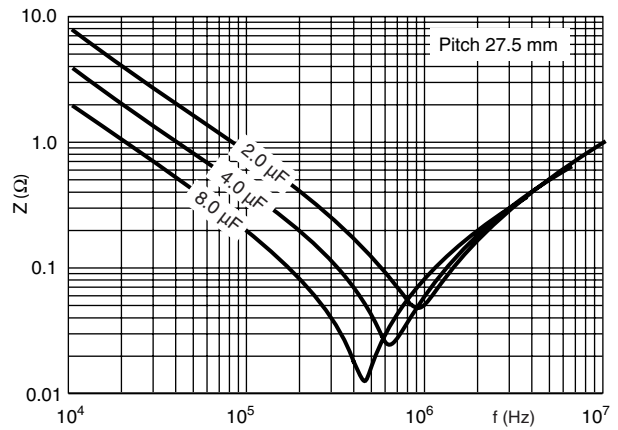

Impedance vs. frequency (typical curve)

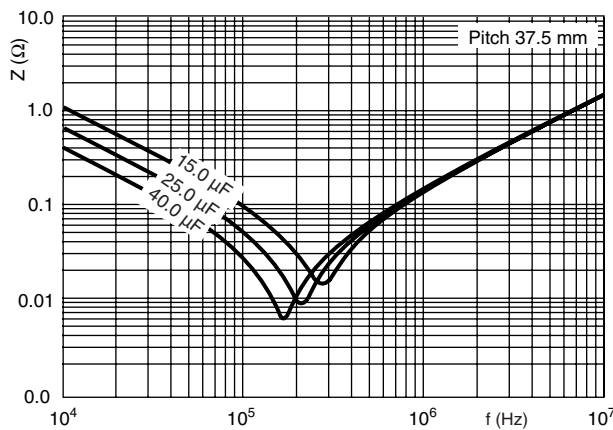

Impedance vs. frequency (typical curve)

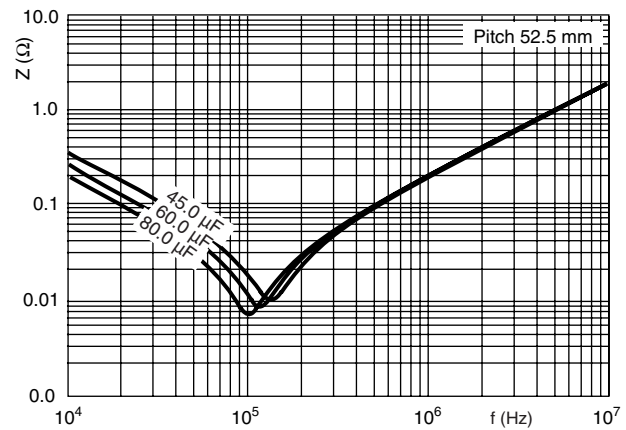

MAXIMUM PEAK TO PEAK RIPPLE VOLTAGE AS A FUNCTION OF FREQUENCY

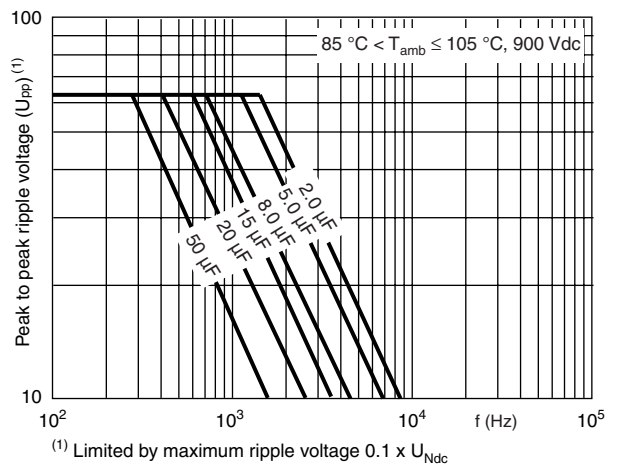
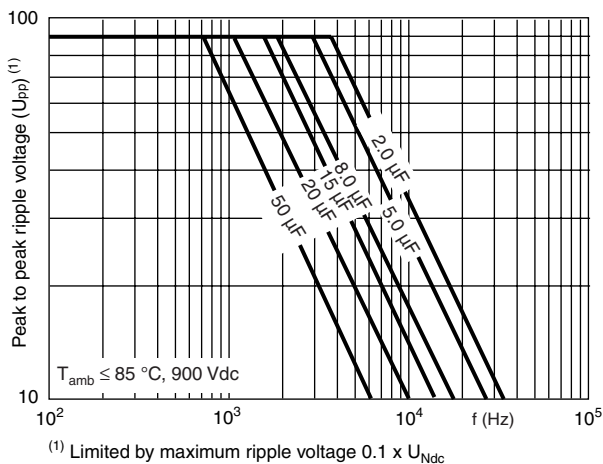
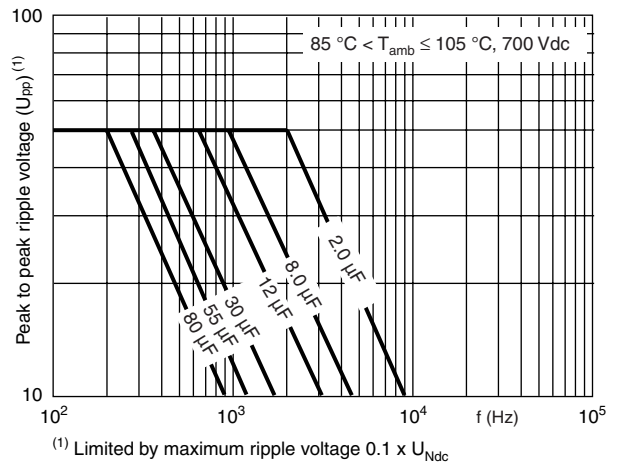
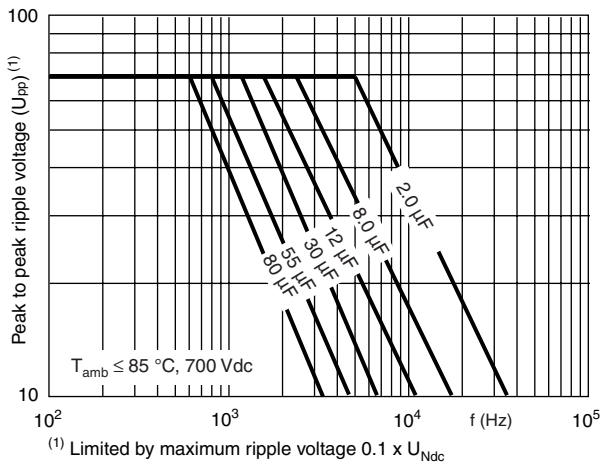
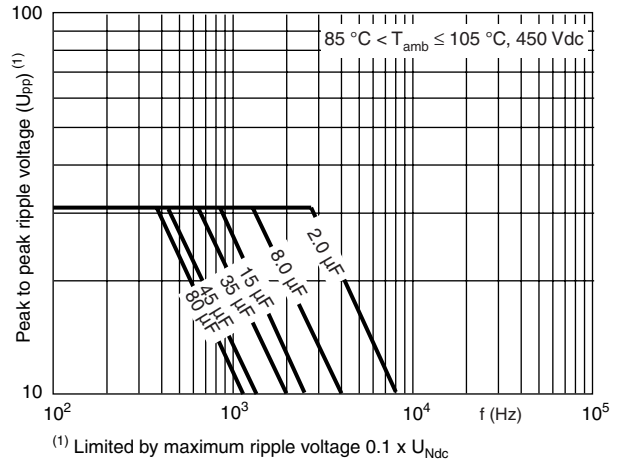
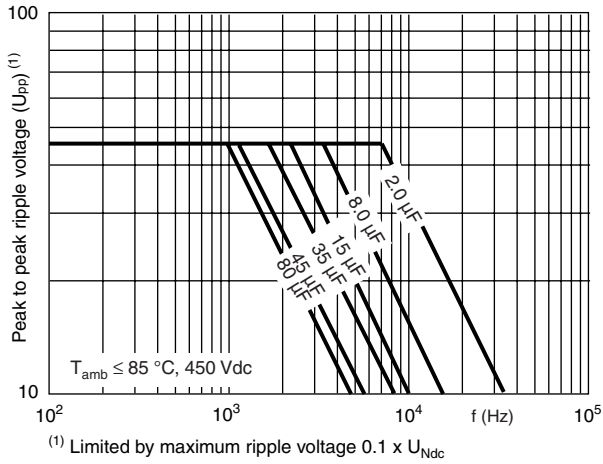



MAXIMUM PEAK TO PEAK RIPPLE VOLTAGE AS A FUNCTION OF FREQUENCY

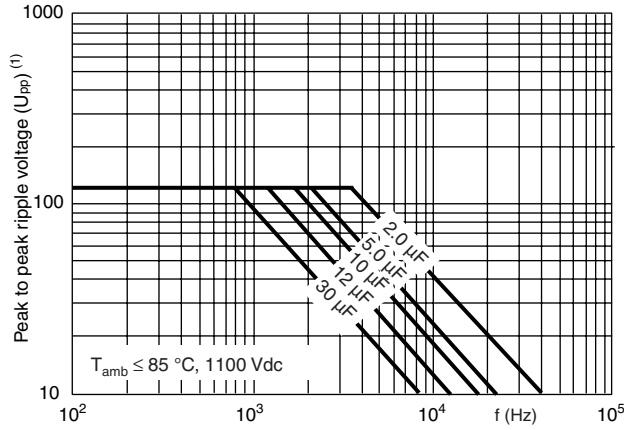

⁽¹⁾ Limited by maximum ripple voltage $0.1 \times U_{Ndc}$

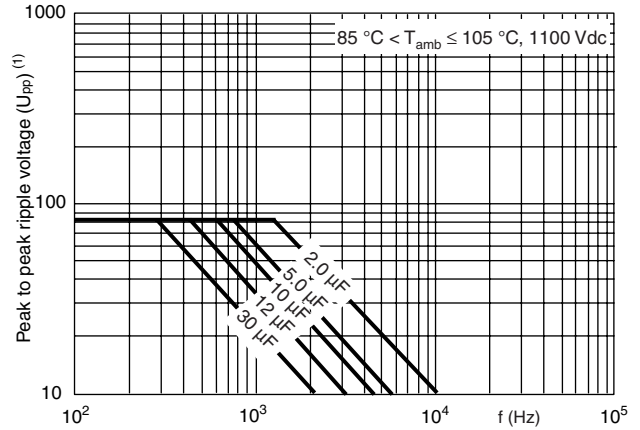

⁽¹⁾ Limited by maximum ripple voltage $0.1 \times U_{Ndc}$

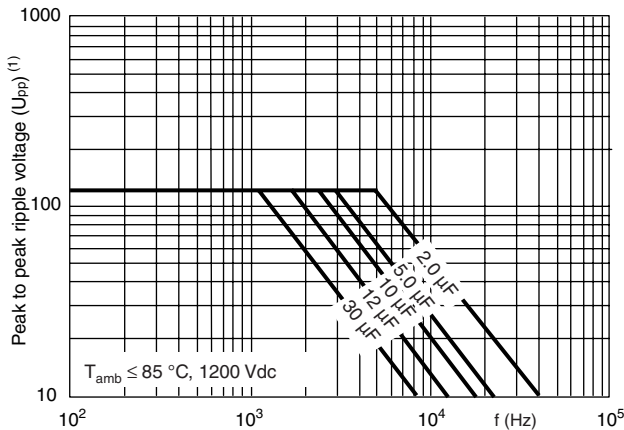

⁽¹⁾ Limited by maximum ripple voltage $0.1 \times U_{Ndc}$

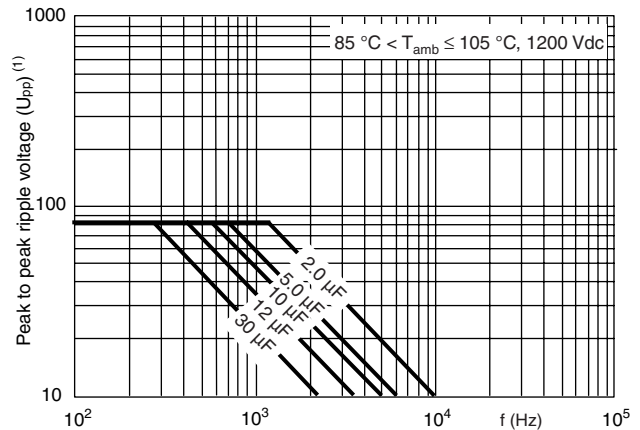

⁽¹⁾ Limited by maximum ripple voltage $0.1 \times U_{Ndc}$

HEAT CONDUCTIVITY AND HOT SPOT TEMPERATURE

| W _{max.} (mm) | HEAT CONDUCTIVITY (mW/°C) | | |
|---------------------------|---------------------------|---------------|---------------|
| | PITCH 27.5 mm | PITCH 37.5 mm | PITCH 52.5 mm |
| 9.0 | 31 | - | - |
| 11.0 | 37 | - | - |
| 13.0 | 42 | - | - |
| 15.0 | 48 | - | - |
| 18.0 | 58 | - | - |
| 18.5 | - | 89 | - |
| 21.0 | 68 | - | - |
| 21.5 | - | 102 | - |
| 24.0 | - | 116 | - |
| 25.0 | - | - | 152 |
| 30.0 | - | 134 | 181 |
| 35.0 | - | - | 197 |
| 45.0 | - | - | 213 |
| 87.0 | - | - | 341 |

POWER DISSIPATION AND MAXIMUM COMPONENT TEMPERATURE RISE

The power dissipation must be limited in order not to exceed the maximum allowed component temperature rise as a function of the free air ambient temperature.

The component temperature rise (ΔT) can be measured or calculated by $\Delta T = P/G$:

- ΔT = Component temperature rise (°C)
- P = Power dissipation of the component (mW)
- G = Heat conductivity of the component (mW/°C)

MEASURING THE COMPONENT TEMPERATURE

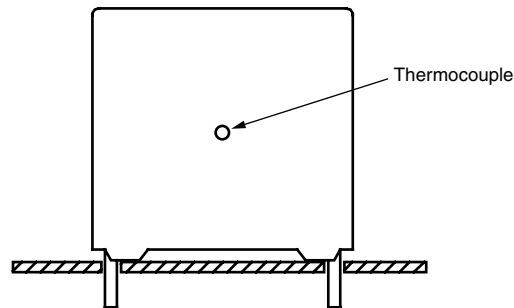

The temperature is measured in unloaded (T_{amb}) and maximum loaded condition (T_C).

The temperature rise is given by $\Delta T = T_C - T_{amb}$.

To avoid thermal radiation or convection, the capacitor must be tested in a closed area from air circulation.

APPLICATION NOTE AND LIMITING CONDITIONS

These capacitors are not suitable for mains applications as across-the-line capacitors without additional protection. These mains applications are strictly regulated in safety standards and therefore electromagnetic interference suppression capacitors conforming the standards must be used.

To select the capacitor for a certain application, the following conditions must be checked:

1. The peak voltage (U_{p+}) shall not be greater than the rated DC voltage (U_{Ndc})
2. The peak-to-peak ripple voltage (U_{p-p}) shall not be greater than $0.1 \times (U_{Ndc})$

Non reversing recurrent waveform

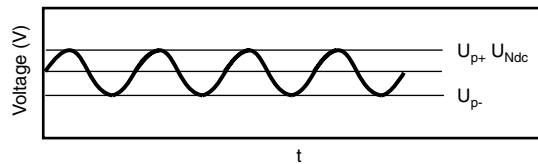

3. The voltage peak slope (dU/dt) shall not exceed the pulse slope at the DC voltage rating.
 If the pulse voltage is lower than the rated DC voltage, the rated voltage pulse slope may be multiplied by U_{Ndc} and divided by the applied voltage.

For all other pulses following equation must be fulfilled:

$$2 \times \int_0^T \left(\frac{dU}{dt} \right)^2 \times dt < U_{Ndc} \times \left(\frac{dU}{dt} \right)_{rated}$$

T is the pulse duration

4. The maximum component surface temperature rise must be lower than 15 °C.

MAXIMUM REPETITIVE PEAK VOLTAGES

The capacitor unit may be subjected to the following surge without any significant reduction of lifetime expectancy

| REPETITIVE SURGE VOLTAGE | MAXIMUM DURATION PER DAY |
|--------------------------|--------------------------|
| $1.1 \times U_{Ndc}$ | 30 % on load duration |
| $1.15 \times U_{Ndc}$ | 30 min |
| $1.2 \times U_{Ndc}$ | 5 min |
| $1.3 \times U_{Ndc}$ | 1 min |
| $1.5 \times U_{Ndc}$ | 110 ms |

INSPECTION REQUIREMENTS

General Notes:

Sub-clause numbers of tests and performance requirements refer to the "Sectional Specification, Publication IEC 61071.

| SUB-CLAUSE NUMBER AND TEST | CONDITIONS | PERFORMANCE REQUIREMENTS |
|--|---|--|
| ROUTINE TEST-FINAL INSPECTION | | |
| 5.14.2.1 External inspection, visual examination | | Legible marking as specified |
| 5.14.2.2 Dimensions | | See specification drawing |
| 5.3.1 Capacitance | 1 kHz at room temperature | See specific reference data |
| 5.3.2 tan δ | 1 kHz at room temperature 10 kHz at room temperature | See specific reference data |
| 5.5.1.2 Voltage test between terminal | $1.5 \times U_{Ndc}$ at T_{amb} Duration 10 s | No visible damage or puncture No flashover |
| 5.7 Insulation resistance | $U_{Ndc} \leq 500$ V measuring voltage 100 V at room temperature $U_{Ndc} > 500$ V measuring voltage 500 V at room temperature Duration 1 min | See specific reference data |
| TYPE TESTS | | |
| 5.14.2 External inspection | Check for finish, marking and overall dimensions | Legible marking and finish as specified Dimensions: see specific drawing |
| 5.14.0 Initial measurements | Capacitance at 1 kHz tan δ at 10 kHz | |
| 5.14.1.1.4 Robustness of terminations IEC 60068-2-21 | Tensile U_a1 Wire diameter section load ≤ 0.8 mm ≤ 0.5 mm ² 10 N ≤ 1.25 mm ≤ 1.2 mm ² 20 N Duration 10 s \pm 1 s Bending U_b method 1 Wire diameter section load ≤ 0.8 mm ≤ 0.05 mm ³ 10 N ≤ 1.25 mm ≤ 0.019 mm ³ 20 N 4 x 90 °, Duration 2 s to 3 s/bend | |
| 5.14.1.6 Resistance to soldering heat IEC 60068-2-20 | No predrying, Method 1A Solder bath: 260 °C \pm 5 °C | |
| 5.14.4 Final measurements | Capacitance tan δ | $ \Delta C/C \leq 0.5$ % Increase of tan $\delta \leq 0.0050$ Compared to values measured in 5.14.0 |
| 5.14.0 Initial measurements | Capacitance at 1 kHz tan δ at 10 kHz | |
| 5.14.3.1 Vibration IEC 60068-2-6 | 10 Hz to 55 Hz: amplitude \pm 0.35 mm or acceleration 98 m/s ² Test duration: 10 frequency cycles, 3 axes offset from each other by 90° 1 octave/min | No visible damage |
| 5.14.3.2 Shock or impact IEC 60068-2-6 | Pulse shape: half sine Acceleration: 490 m/s ² Duration t of pulse: 11 ms Visual examination | No visible damage |
| 5.14.4 Final measurements | Capacitance tan δ | $ \Delta C/C \leq 0.5$ % Increase of tan $\delta \leq 0.0050$ Compared to values measured in 5.14.0 |



Metallized Polypropylene Film Capacitors Vishay Roederstein
DC Capacitor MKP Type

| SUB-CLAUSE NUMBER AND TEST | CONDITIONS | PERFORMANCE REQUIREMENTS |
|---|---|--|
| 5.5.3.1 Initial measurements 5.5.3.2 Voltage test between terminal 5.5.3.3 Final measurements | Capacitance at 1 kHz tan δ at 10 kHz R insulation 1.5 x U _{Ndc} at T _{amb.} Duration 60 s Capacitance tan δ R insulation | $\Delta C/C$ ≤ 0.5 % Increase of tan δ ≤ 1.2 initial tan δ + 0.0001 R insulation ≥ 50 % of specified values |
| 5.9.1 Initial measurements 5.9.2 Surge discharge test 5.9.3 Voltage test between terminal 5.9.3 Final measurements | Capacitance at 1 kHz tan δ at 10 kHz 1.1 x U _{Ndc} Number of discharges: 5 Time lapse: every 2 min (10 min total) Within 5 min after the surge discharge test Duration 60 s 1.5 x U _{Ndc} at T _{amb.} Capacitance tan δ at 10 kHz | $\Delta C/C$ ≤ 1.0 % tan δ ≤ 1.2 initial tan δ + 0.0001 Compared to values measured in 5.9.1 |
| 5.11.1 Initial measurements 5.11.2 Self healing test 5.11.3 Final measurements | Capacitance at 1 kHz tan δ at 10 kHz 1.5 x U _{Ndc} Duration 10 s Number of clearings ≤ 5 Clearing = voltage drop of 5 % increase the voltage at 100 V/s till 5 clearings occur with a max. of 2.5 x U _{Ndc} for a duration of 10 s Capacitance tan δ | $\Delta C/C$ ≤ 0.5 % tan δ ≤ 1.2 x initial tan δ + 0.0001 Compared to values measured in 5.11.1 |
| 5.13.0 Initial measurements 5.13.1 Change of temperature acc to IEC 60068-2-14 5.13.2 Damp heat steady state Acc. to IEC 60068-2-78 5.5.3.2 Voltage test between terminal 5.13.3 Final measurements | Capacitance at 1 kHz tan δ at 10 kHz Test Nb T _{max.} = 85 °C T _{min.} = - 40 °C Transition time: 1 h, equivalent to 1 °C/min 5 cycles Test Ca T _{max.} = 40 ± 2 °C RH = 93 ± 3 % Duration 56 days 1.5 x U _{Ndc} at ambient temperature Duration 60 s Visual examination Capacitance tan δ at 1 U _{rms} 10 kHz | No puncturing or flashover Self healing punctures are permitted $\Delta C/C$ ≤ 2.0 % Increase of tan δ ≤ 0.0150 Compared to values measured in 5.13.0 |
| 5.10.0 Initial measurements 5.10.1 Thermal stability test under overload conditions 5.10.2 Final measurements | Capacitance at 1 kHz tan δ at 10 kHz Natural cooling T _{amb} ± 5 °C 1.21 x P _{max.} = (U ₂ /2) x W ₂ x C x tan δ = 121 x (I ² _{max.} /W ₂ x c) x tan δ ₂ with W ₂ = 2 x p x f ₂ for I _{max.} (see specific reference data) f ₂ = 10 kHz Duration 48 h Measure the temperature every 1.5 h during the last 6 h Capacitance tan δ at 10 kHz | temperature rise < 1 °C $\Delta C/C$ ≤ 2 % Increase of tan δ ≤ 1.2 x initial δ + 0.0150 |

MKP 1848 DC-Link



Vishay Roederstein Metallized Polypropylene Film Capacitors DC Capacitor MKP Type

| SUB-CLAUSE NUMBER AND TEST | CONDITIONS | PERFORMANCE REQUIREMENTS |
|--|---|--|
| 5.12 Resonance frequency measurement | Impedance analyser at T_{amb} | < 0.9 times the value as specified in typical curve "Resonant frequency" of this specification |
| 5.10.0 Initial measurements 5.15.1 Endurance test between terminals 5.15.2 Final measurements | Capacitance at 1 kHz tan δ at 10 kHz Sequence 1.4 x U_{Ndc} at $T_{max.} = 85^\circ C$ Duration 250 h 1000 x discharge at 1.4 x I (maximum repetitive peak current in continuous operation) 1.4 x U_{Ndc} at $T_{max.} = 85^\circ C$ Duration 250 h Capacitance tan δ | $ \Delta C/C \leq 3\%$ Increase of tan $\delta \leq 0.0150$ Compared to values measured in 5.15.0 |
| 5.16.3.0 Initial measurements 5.16.3.1 Destruction test sequence DC voltage with superimposed AC voltage switched to high DC voltage 5.5.3 Voltage test between terminal 5.16.3.2 Final measurements | Capacitance at 1 kHz at $T_{max.} = 85^\circ C$ 1.3 x U_{Ndc} with superimposed AC voltage at 1.1 x in (I_{rms}) Duration = 5 min Switch to high DC voltage = 2 x U_{Ndc} Duration 10 s Apply number of cycles till capacitance drop (open circuit) occur. 1.5 x U_{Ndc} at T_{amb} Duration 60 s Visual examination | Capacitance value < 10 % of measured in 5.16.3.0 No puncturing or flashover Self healing punctures are permitted |



Disclaimer

All product specifications and data are subject to change without notice.

Vishay Intertechnology, Inc., its affiliates, agents, and employees, and all persons acting on its or their behalf (collectively, "Vishay"), disclaim any and all liability for any errors, inaccuracies or incompleteness contained herein or in any other disclosure relating to any product.

Vishay disclaims any and all liability arising out of the use or application of any product described herein or of any information provided herein to the maximum extent permitted by law. The product specifications do not expand or otherwise modify Vishay's terms and conditions of purchase, including but not limited to the warranty expressed therein, which apply to these products.

No license, express or implied, by estoppel or otherwise, to any intellectual property rights is granted by this document or by any conduct of Vishay.

The products shown herein are not designed for use in medical, life-saving, or life-sustaining applications unless otherwise expressly indicated. Customers using or selling Vishay products not expressly indicated for use in such applications do so entirely at their own risk and agree to fully indemnify Vishay for any damages arising or resulting from such use or sale. Please contact authorized Vishay personnel to obtain written terms and conditions regarding products designed for such applications.

Product names and markings noted herein may be trademarks of their respective owners.