

# SMDT-250I



## Diode-Thyristor Module



Type	$V_{RSM}$	$V_{RRM}$ , $V_{DRM}$
SMDT-250I-08	900	800
SMDT-250I-12	1300	1200
SMDT-250I-14	1500	1400
SMDT-250I-16	1700	1600
SMDT-250I-18	1900	1800

www.DataSheet4U.com

Type	$I_{TAVM}$ , $I_{FAVM}$	$I_{TRMS}$ , $I_{FRMS}$	$T_c$	$I_{TSM}$ , $I_{FSM}$	$(di/dt)_{cr}$	$(dv/dt)_{cr}$	$V_{TM}$	$I_{TM}$ , $I_{FM}$	$V_{TO}$	$r_T$	$t_q$	$V_{GT}$	$I_{GT}$	$T_{VJM}$	$V_{isol}$	$R_{thJC}$
	A	A	°C	kA	A/μs	V/μs	V	A	V	mΩ	μs	V	mA	°C	V	K/W
SMDT-250I	253	400	85	8.5	250	1000	1.7	750	0.85	1.1	150	2.0	150	125	3600	0.129

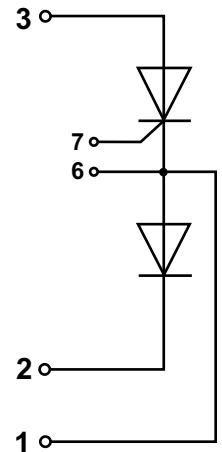
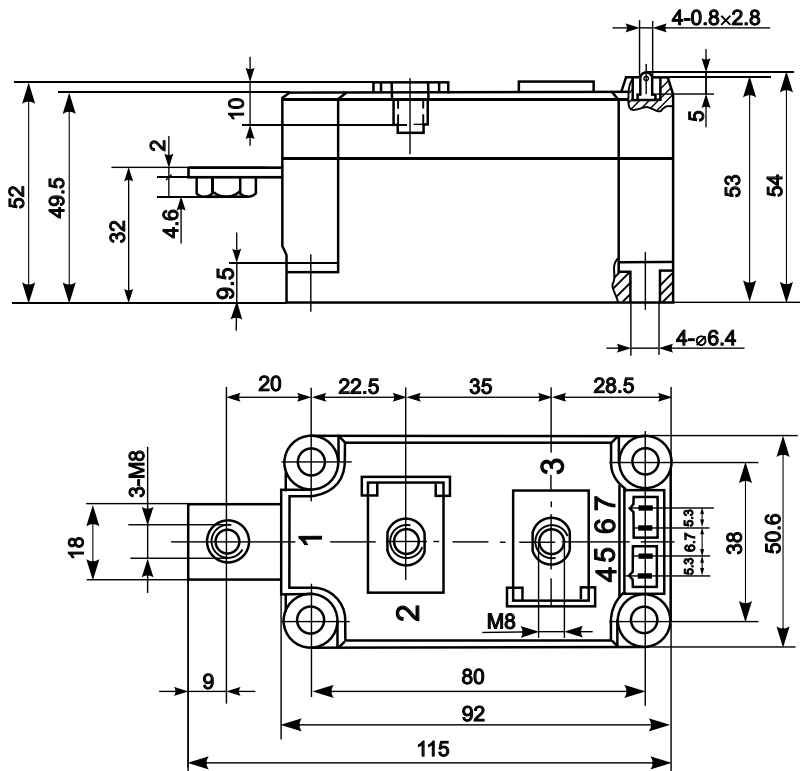

### Features:

- Industrial standard package
- Heat transfer through aluminium nitride ceramic isolated metal baseplate
- Precise internal pressure contacts for high reliability
- 3600V RMS isolation voltage

### Typical Applications:

- DC motor control
- AC motor soft starter
- Temperature control (e.g. for ovens, chemical processes)
- Lighting control