

**> Features**

- High Speed Switching
- Low On-Resistance
- No Secondary Breakdown
- Low Driving Power
- High Voltage
- $V_{GS} = \pm 30V$  Guarantee
- Avalanche Proof

**> Applications**

- Switching Regulators
- UPS
- DC-DC converters
- General Purpose Power Amplifier

**> Outline Drawing**

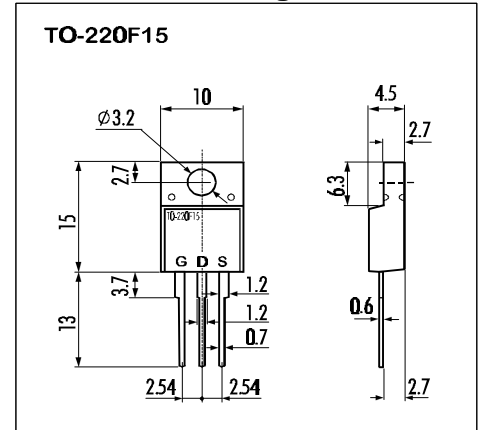

**> Maximum Ratings and Characteristics**

- Absolute Maximum Ratings ( $T_C=25^\circ C$ ), unless otherwise specified

Item	Symbol	Rating	Unit
Drain-Source-Voltage	$V_{DS}$	250	V
Drain-Gate-Voltage( $R_{GS}=20K\Omega$ )	$V_{DGR}$	250	V
Continous Drain Current	$I_D$	18	A
Pulsed Drain Current	$I_{D(puls)}$	72	A
Gate-Source-Voltage	$V_{GS}$	$\pm 30$	V
Max. Power Dissipation	$P_D$	50	W
Operating and Storage Temperature Range	$T_{ch}$	150	$^\circ C$
	$T_{stg}$	-55 ~ +150	$^\circ C$

**> Equivalent Circuit**

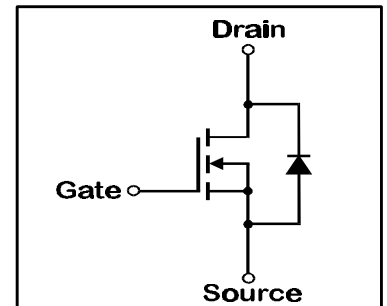

- Electrical Characteristics ( $T_C=25^\circ C$ ), unless otherwise specified

Item	Symbol	Test conditions	Min.	Typ.	Max.	Unit
Drain-Source Breakdown-Voltage	$V_{(BR)DSS}$	$I_D=1mA$ $V_{GS}=0V$	250			V
Gate Threshold Voltage	$V_{GS(th)}$	$I_D=1mA$ $V_{DS}=V_{GS}$	2,5	3,0	3,5	V
Zero Gate Voltage Drain Current	$I_{DSS}$	$V_{DS}=250V$ $T_{ch}=25^\circ C$		10	500	$\mu A$
		$V_{GS}=0V$ $T_{ch}=125^\circ C$		0,2	1,0	mA
Gate Source Leakage Current	$I_{GSS}$	$V_{GS}=\pm 30V$ $V_{DS}=0V$		10	100	nA
Drain Source On-State Resistance	$R_{DS(on)}$	$I_D=9A$ $V_{GS}=10V$		0,13	0,18	$\Omega$
Forward Transconductance	$g_{fs}$	$I_D=9A$ $V_{DS}=25V$	7	14		S
Input Capacitance	$C_{iss}$	$V_{DS}=25V$		1750	2650	pF
Output Capacitance	$C_{oss}$	$V_{GS}=0V$		290	440	pF
Reverse Transfer Capacitance	$C_{rss}$	$f=1MHz$		65	100	pF
Turn-On-Time $t_{on}$ ( $t_{on}=t_{d(on)}+t_r$ )	$t_{d(on)}$	$V_{CC}=150V$		30	45	ns
		$I_D=18A$		50	75	ns
	$t_r$	$V_{GS}=10V$		80	120	ns
		$R_{GS}=10\Omega$		70	110	ns
Turn-Off-Time $t_{off}$ ( $t_{off}=t_{d(off)}+t_f$ )	$t_{d(off)}$	$V_{GS}=10V$		80	120	ns
		$R_{GS}=10\Omega$		70	110	ns
	$t_f$	$V_{GS}=10V$		80	120	ns
		$R_{GS}=10\Omega$		70	110	ns
Avalanche Capability	$I_{AV}$	$L=100\mu H$ $T_{ch}=25^\circ C$	18			A
Continous Reverse Drain Current	$I_{DR}$				18	A
Pulsed Reverse Drain Current	$I_{DRM}$				72	A
Diode Forward On-Voltage	$V_{SD}$	$I_F=2I_{DR}$ $V_{GS}=0V$ $T_{ch}=25^\circ C$		1	1,5	V
Reverse Recovery Time	$t_{rr}$	$I_F=I_{DR}$ $V_{GS}=0V$		150		ns
Reverse Recovery Charge	$Q_{rr}$	$-dI_F/dt=100A/\mu s$ $T_{ch}=25^\circ C$		1		$\mu C$

- Thermal Characteristics

Item	Symbol	Test conditions	Min.	Typ.	Max.	Unit
Thermal Resistance	$R_{th(ch-a)}$	channel to air			62,5	$^\circ C/W$
	$R_{th(ch-c)}$	channel to case			2,5	$^\circ C/W$

N-channel MOS-FET			
250V	0,18Ω	18A	50W

# 2SK2255-01MR

## FAP-IIA Series



### > Characteristics

Typical Output Characteristics

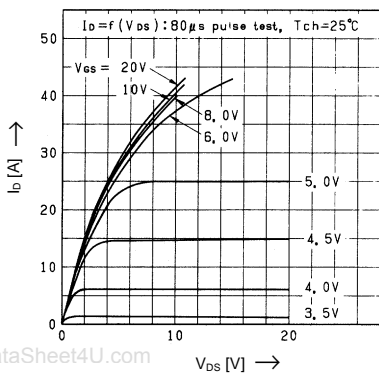

Drain-Source-On-State Resistance vs.  $T_{ch}$

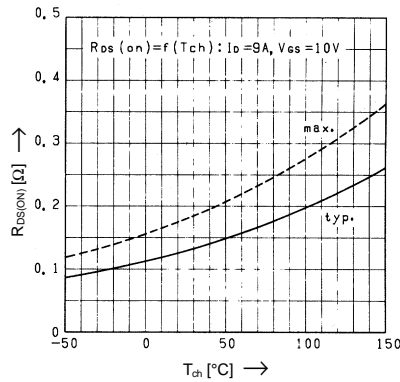

Typical Transfer Characteristics

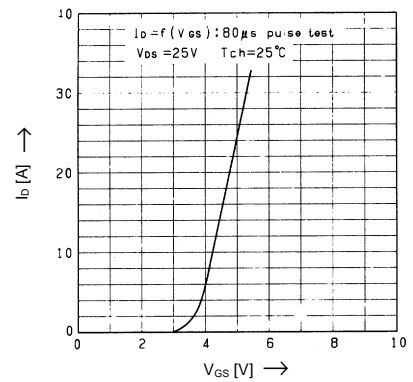

Typical Drain-Source-On-State-Resistance vs.  $I_D$

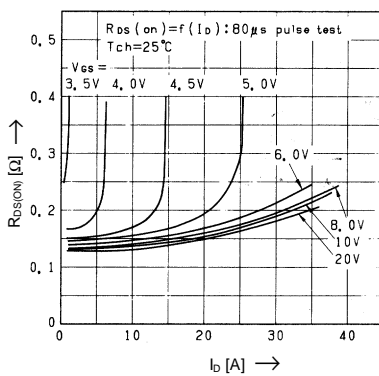

Typical Forward Transconductance vs.  $I_D$

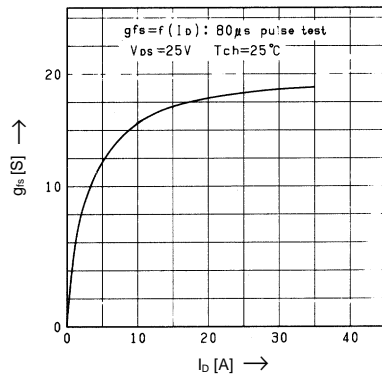

Gate Threshold Voltage vs.  $T_{ch}$

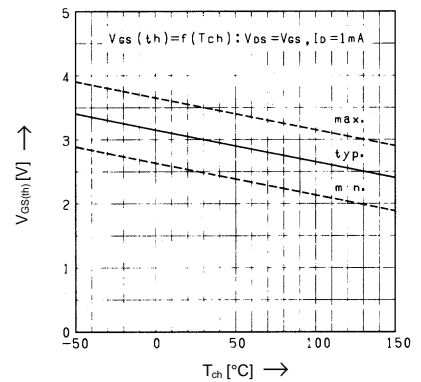

Typical Capacitance vs.  $V_{DS}$

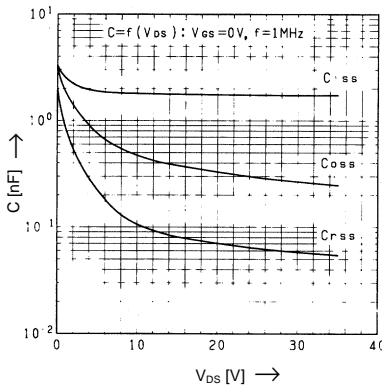

Typical Input Charge

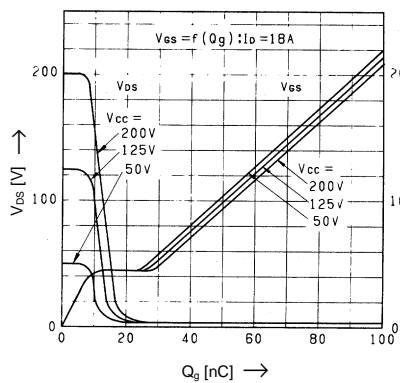

Forward Characteristics of Reverse Diode

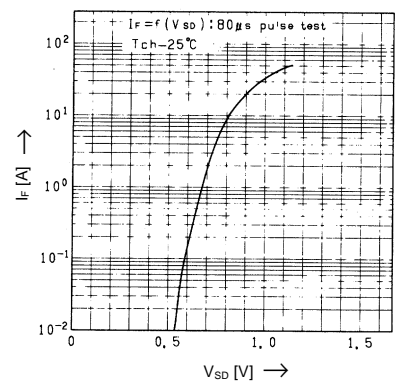

Allowable Power Dissipation vs.  $T_C$

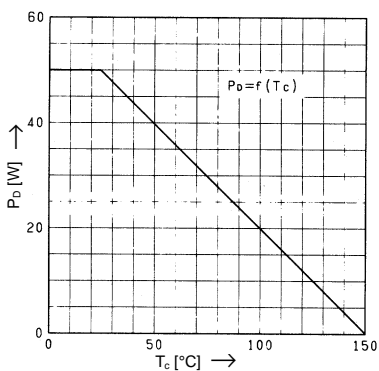

Safe operation area

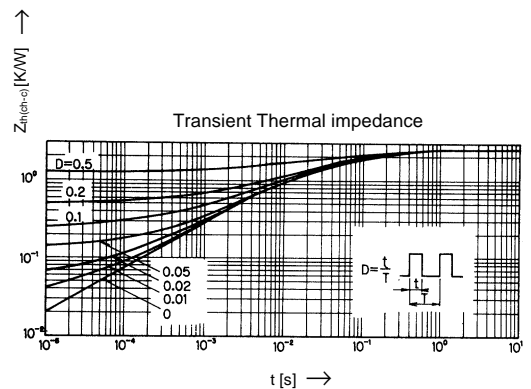
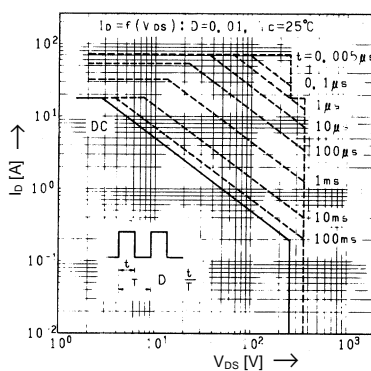

This specification is subject to change without notice!