

2SK1357

HIGH SPEED, HIGH CURRENT SWITCHING APPLICATIONS.
DC-DC CONVERTER AND MOTOR DRIVE APPLICATIONS.

- Low Drain-Source ON Resistance : $R_{DS(ON)} = 2.5\Omega$ (Typ.)
- High Forward Transfer Admittance : $|Y_{fs}| = 2.0S$ (Typ.)
- Low Leakage Current : $I_{DSS} = 300\mu A$ (Max.) @ $V_{DS} = 720V$
- Enhancement-Mode : $V_{th} = 1.5 \sim 3.5V$ @ $V_{DS} = 10V, I_D = 1mA$

MAXIMUM RATINGS ($T_a = 25^\circ C$)

CHARACTERISTIC		SYMBOL	RATING	UNIT
Drain-Source Voltage		V_{DSS}	900	V
Drain-Gate Voltage ($R_{GS} = 20k\Omega$)		V_{DGR}	900	V
Gate-Source Voltage		V_{GSS}	± 30	V
Drain Current	DC	I_D	5	A
	Pulse	I_{DP}	15	
Drain Power Dissipation ($T_c = 25^\circ C$)		P_D	125	W
Channel Temperature		T_{ch}	150	$^\circ C$
Storage Temperature Range		T_{stg}	$-55 \sim 150$	$^\circ C$

THERMAL CHARACTERISTICS

CHARACTERISTIC	SYMBOL	MAX.	UNIT
Thermal Resistance, Channel to Case	$R_{th(ch-c)}$	1.0	$^\circ C/W$
Thermal Resistance, Channel to Ambient	$R_{th(ch-a)}$	50	$^\circ C/W$

THIS TRANSISTOR IS AN ELECTROSTATIC SENSITIVE DEVICE.

PLEASE HANDLE WITH CAUTION.

INDUSTRIAL APPLICATIONS

Unit in mm

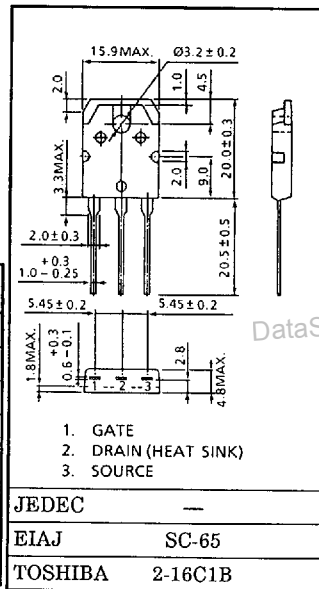

Weight : 4.6g

ELECTRICAL CHARACTERISTICS (Ta = 25°C)

CHARACTERISTIC		SYMBOL	TEST CONDITION	MIN.	TYP.	MAX.	UNIT
Gate Leakage Current		I_{GSS}	$V_{GS} = \pm 25V, V_{DS} = 0V$	—	—	± 100	nA
Drain Cut-off Current		I_{DSS}	$V_{DS} = 720V, V_{GS} = 0V$	—	—	300	μA
Drain-Source Breakdown Voltage		$V_{(BR)DSS}$	$I_D = 10mA, V_{GS} = 0V$	900	—	—	V
Gate Threshold Voltage		V_{th}	$V_{DS} = 10V, I_D = 1mA$	1.5	—	3.5	V
Drain-Source ON Resistance		$R_{DS(ON)}$	$I_D = 2A, V_{GS} = 10V$	—	2.5	2.8	Ω
Forward Transfer Admittance		$ Y_{fs} $	$V_{DS} = 20V, I_D = 2A$	1.0	2.0	—	S
Input Capacitance		C_{iss}	$V_{DS} = 25V, V_{GS} = 0V, f = 1MHz$	—	700	1000	pF
Reverse Transfer Capacitance		C_{rss}		—	55	90	
Output Capacitance		C_{oss}		—	100	150	
Switching Time	Rise Time	t_r		—	18	35	ns
	Turn-on Time	t_{on}		—	30	60	
	Fall Time	t_f		—	12	25	
	Turn-off Time	t_{off}		—	70	140	
Total Gate Charge (Gate-Source Plus Gate-Drain)		Q_g	$V_{DD} = 400V, V_{GS} = 10V, I_D = 4A$	—	60	120	nC
Gate-Source Charge		Q_{gs}		—	35	—	
Gate-Drain ("Miller") Charge		Q_{gd}		—	22	—	

SOURCE-DRAIN DIODE RATINGS AND CHARACTERISTICS (Ta = 25°C)

CHARACTERISTIC	SYMBOL	TEST CONDITION	MIN.	TYP.	MAX.	UNIT
Continuous Drain Reverse Current	I_{DR}	—	—	—	4	A
Pulse Drain Reverse Current	I_{DRP}	—	—	—	—	A
Diode Forward Voltage	V_{DSF}	$I_{DR} = 4A, V_{GS} = 0V$	—	—	-1.9	V
Reverse Recovery Time	t_{rr}	$I_{DR} = 4A, V_{GS} = 0V$	—	500	—	ns
Reverse Recovered Charge	Q_{rr}	$dI_{DR} / dt = 100A / \mu s$	—	0.13	—	μC

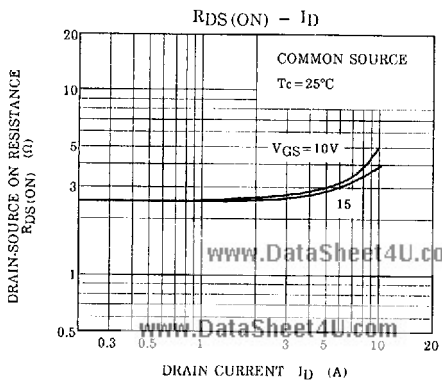
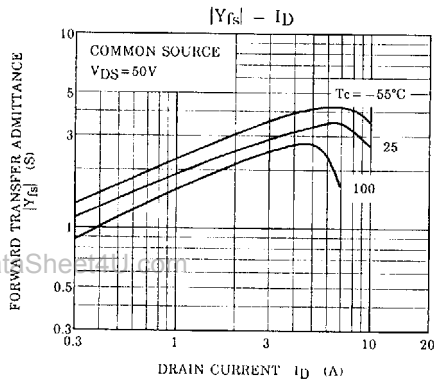
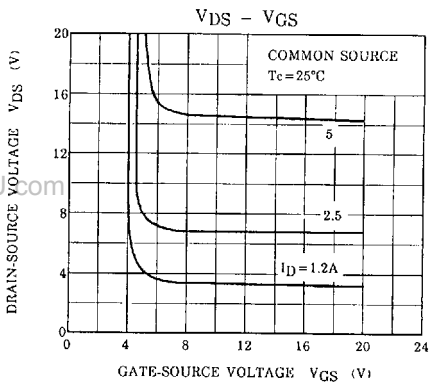
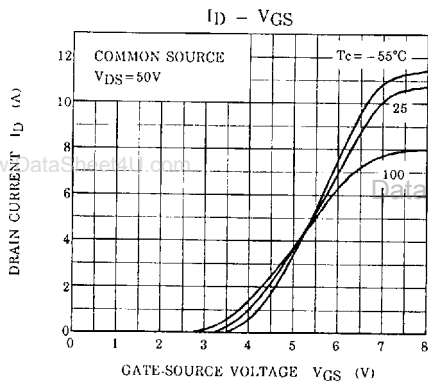
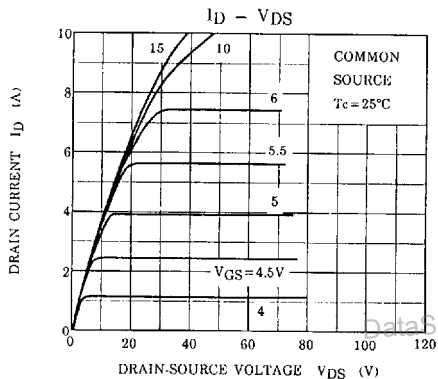
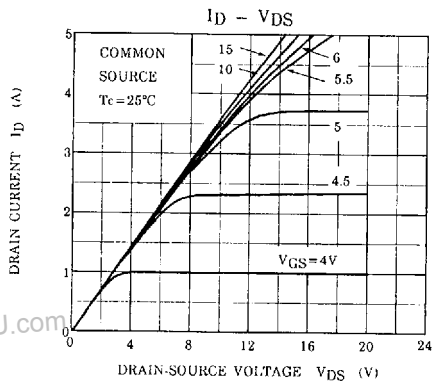

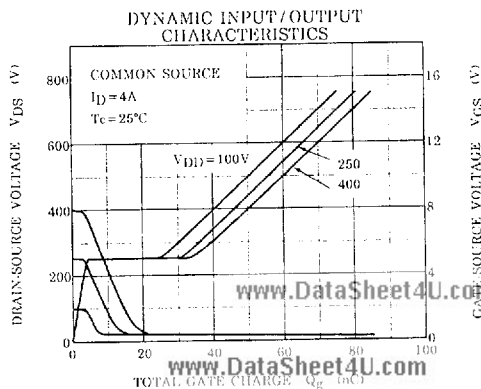
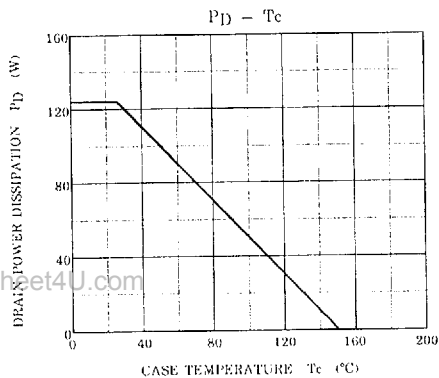
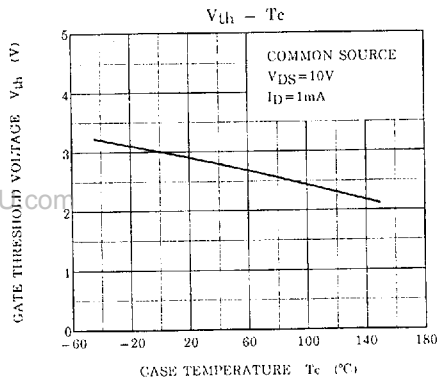
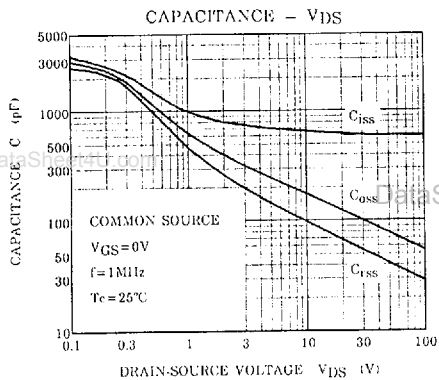
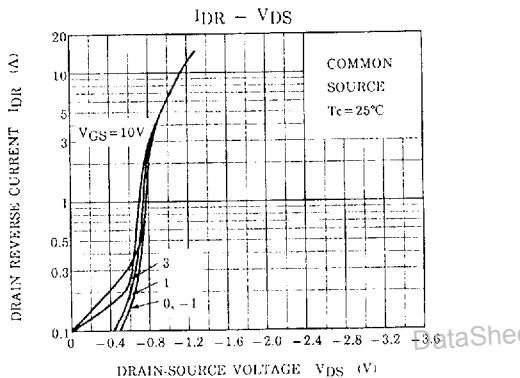
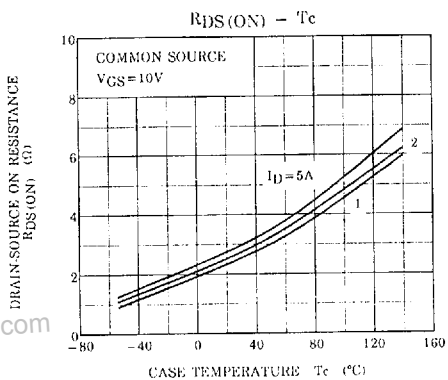

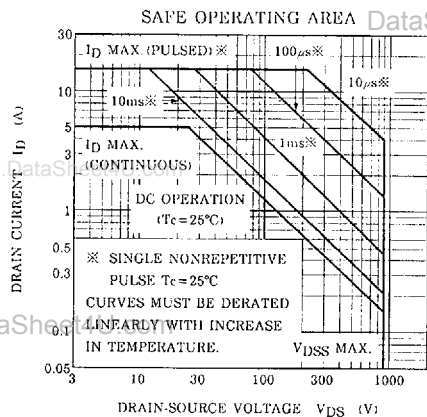
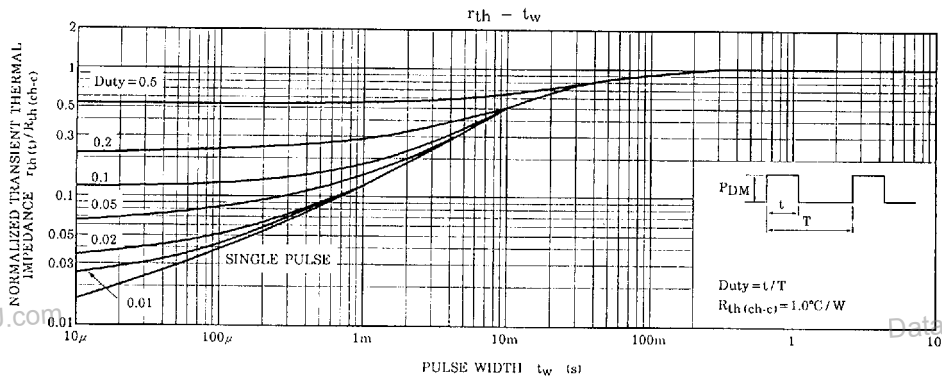

POWER-MINI (SOT-89)

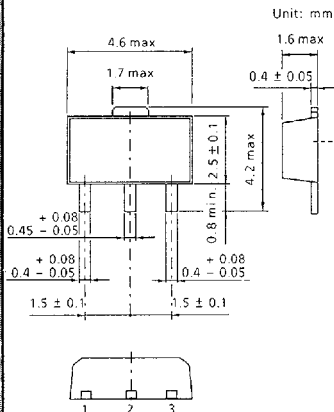

1. GATE
2. DRAIN (HEAT SINK)
3. SOURCE

SP (SOT-223)

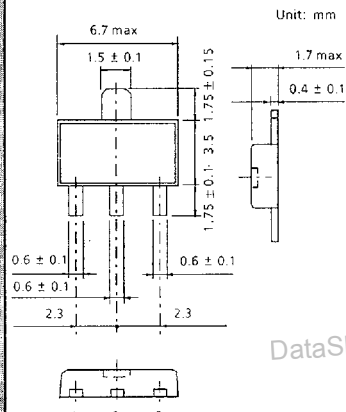

1. GATE
2. DRAIN (HEAT SINK)
3. SOURCE

TO92-MOD

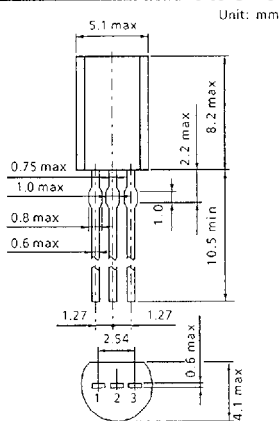

1. SOURCE
2. DRAIN
3. GATE

POWER-MOLD (Straight)

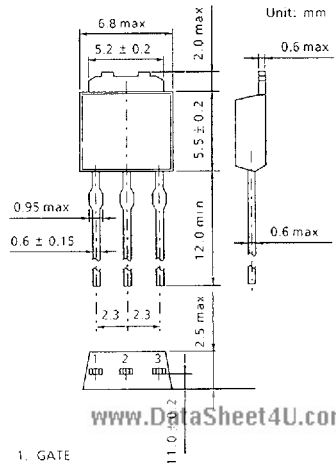

1. GATE
2. DRAIN (HEAT SINK)
3. SOURCE

POWER-MOLD (Lead Formed)

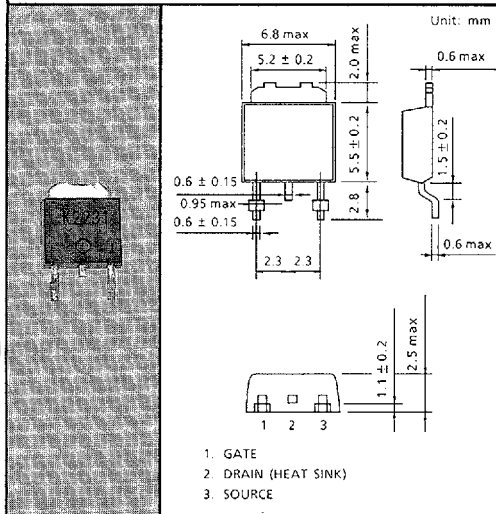

DP (Straight)

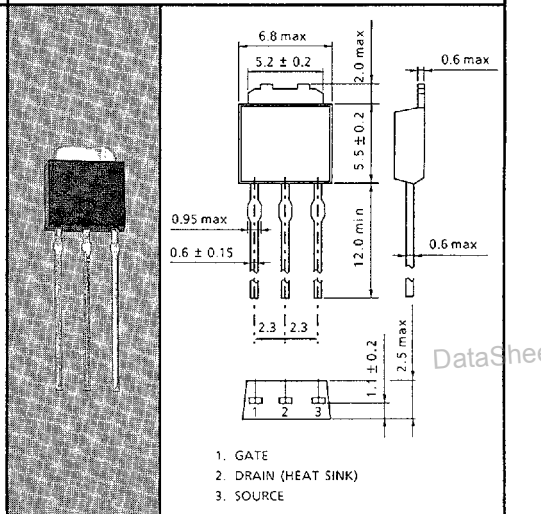

DP (Lead Forming)

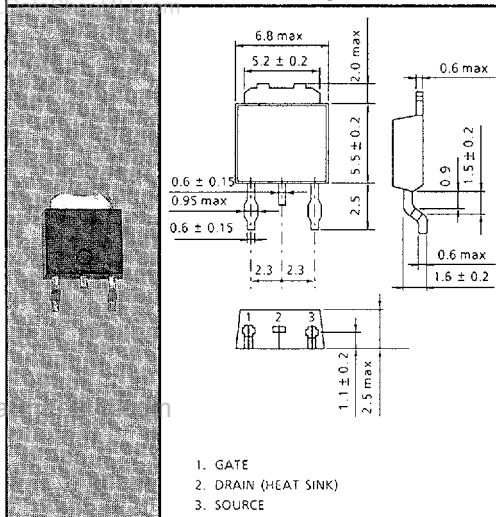

TPS

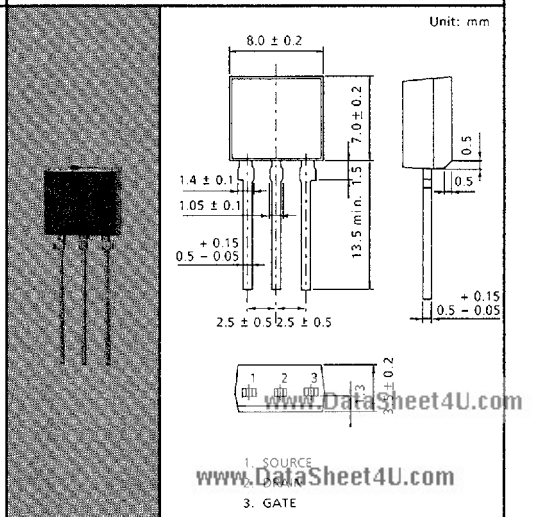

TO-220AB

Unit: mm

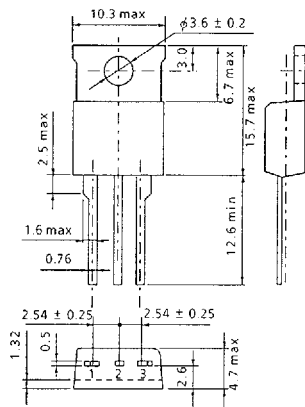

1. GATE
2. DRAIN (HEAT SINK)
3. SOURCE

TO-220 (IS)

Unit: mm

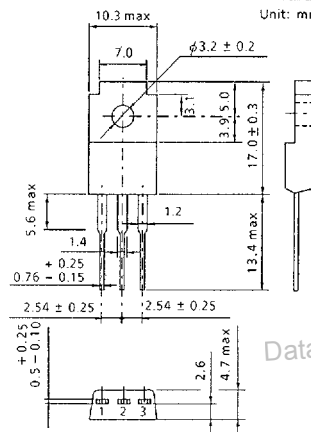

1. GATE
2. DRAIN
3. SOURCE

TO-220 (NIS)

Unit: mm

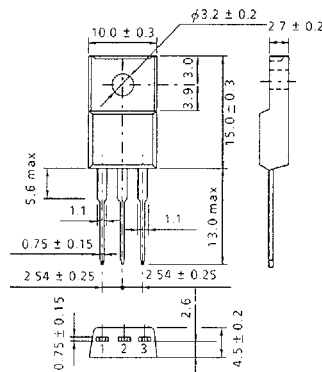

1. GATE
2. DRAIN
3. SOURCE

TO-220FL

Unit: mm

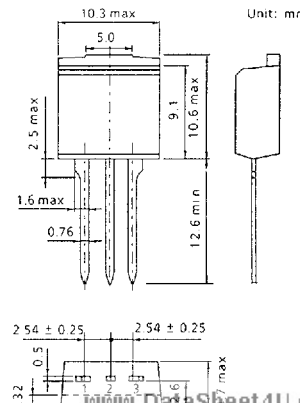

1. GATE
2. DRAIN (HEAT SINK)
3. SOURCE

TO-220SM

單位 : mm

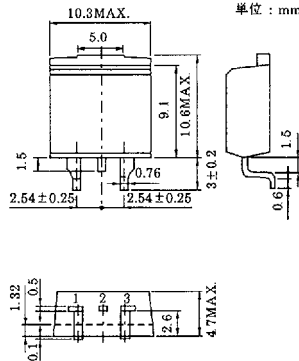

1. GATE
2. DRAIN (HEAT SINK)
3. SOURCE

TO-3P (N)

單位 : mm

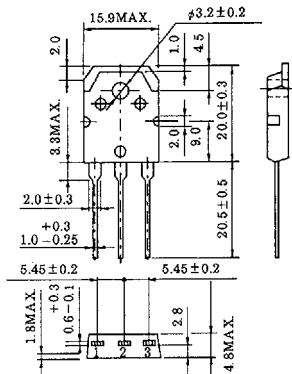

1. GATE
2. DRAIN (HEAT SINK)
3. SOURCE

TO-3P (N) IS

單位 : mm

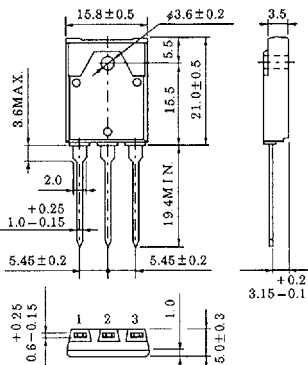

1. GATE
2. DRAIN
3. SOURCE

TO-3P (L)

單位 : mm

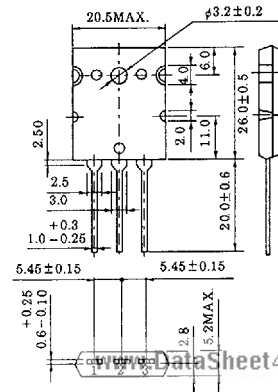

1. GATE
2. DRAIN (HEAT SINK)
3. SOURCE