

### Features

- ❑ Optimized for BCD Motor Application
- ❑ Operating Voltage Range: 2.2V to 18V
- ❑ CMOS Device for Optimal Stability
- ❑ Chopper Stabilized: No Amplifier Offset Voltage
- ❑ Activate With Commercially Available Permanent Magnets
- ❑ Thin, High Reliability SIP Package
- ❑ Available in SQT23 Package
- ❑ Solid State Switch with  $I_{CC} = 20\text{mA}$

The FUS3881 Hall-Effect sensor IC family is designed in CMOS technology providing chopper stabilized amplifiers with switched capacitors. Therefore these magnetic field sensor devices have no amplifier offset voltage which in bipolar designed devices is the main reason for temperature sensitive output signal drift.

The sensors output transistor will be in the “latched-on” state ( $B_{OP}$ ) in the presence of a sufficiently strong South-Pole magnetic field, facing the marked side of the SIP package. The sensor output will be in the “latched-off state ( $B_{RP}$ )” in the presence of a North-Pole field.

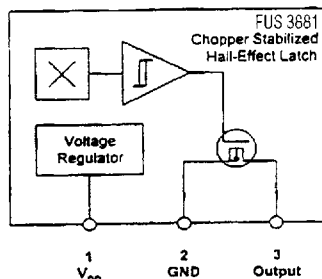

The FUS3881 sensor family comes in four guaranteed temperature specifications to meet the needs of various commercial and industrial applications.

Typical applications for these devices are: sensing of speed, linear position, and angular position. Though there are many applications where the FUS3881 sensor IC can be used, its performances have been optimized for commutation applications of 5V and 12V brushless DC motors.

### Absolute Maximum Ratings

Characteristic	Symbol	Device	Rating	Unit
Power Supply Voltage	$V_{CC}$	All	20	V
Supply Current	$I_{CC}$	All	10	mA
Output Switch Current	$I_{OUT}$	All	20	mA
Power Dissipation	$P_D$	All	100	mW
Operating Ambient Temperature Range	$T_A$	FUS 3681UA	0 ... +70	°C
		FUS 3681SUA	-20 ... +85	
		FUS 3681EUA	-40 ... +85	
Storage Temperature Range	$T_S$	ALL	-65 ... +150	°C

**Electrical Characteristics at TA = 25°C, +/-2°C, V<sub>DD</sub> = 12V (unless otherwise noted)**

Characteristics	Symbol	Applicable Devices	Test Conditions	Limits			Units
				Min.	Typ.	Max.	
Supply Voltage	V <sub>DD</sub>	All	Operating	2.2		20	V
Supply Current	I <sub>DD</sub>	All	B < B <sub>RP</sub>	5	6	8	mA
Saturation Voltage	V <sub>OS(ON)</sub>	All	I <sub>OUT</sub> = 20mA    B > B <sub>OP</sub>	0.4		0.5	V
Output Leakage Current	I <sub>R</sub>	All	B < BRP    V <sub>OUT</sub> = 20V	0.01		4	μA
Propagation Delay Low to High (Turn-On)	t <sub>PLH</sub>	All	RI = 1.1kΩ    CI = 20pF		0.04		μs
Propagation Delay High to Low (Turn-Off)	t <sub>PHL</sub>	All	RI = 1.1kΩ    CI = 20pF		0.18		μs

**FUS 3881 Series Latch - Magnetic characteristics**

Characteristics	Symbol	Limits at 25°C			Units
		Min.	Typ.	Max.	
Magnetic Thresholds Turn-On	B <sub>OP</sub>	10	45	90	G
Magnetic Thresholds Turn-Off	B <sub>RP</sub>	-90	-45	-10	G
Hysteresis (B <sub>OP</sub> - B <sub>RP</sub> )	B <sub>HYS</sub>	70	90	140	G

Supply Current vs Supply Voltage

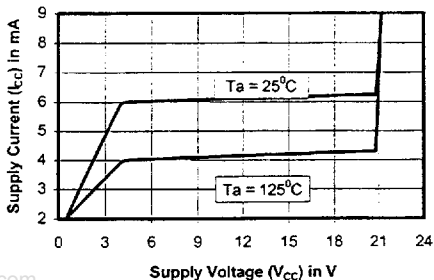

Typical Hysteresis vs Temperature

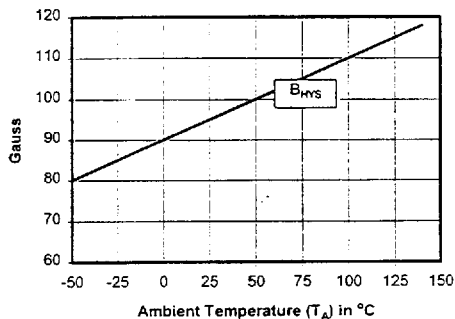

Magnetic Switch Points vs Temperature

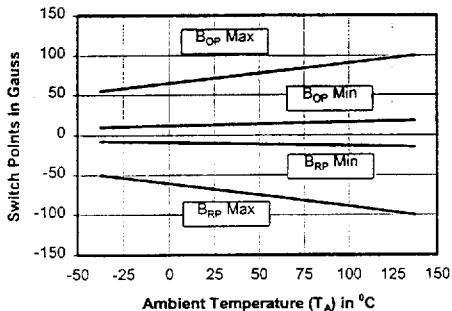

Typical Switch Points vs Temperature

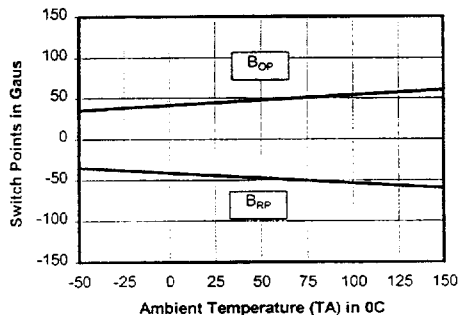

Typical Saturation Voltage vs Temperature

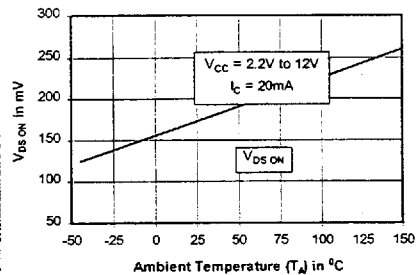

Wave Soldering Parameters

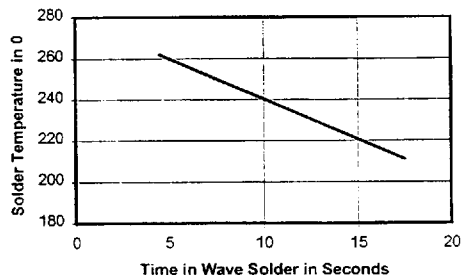

### 3 Lead SIP Package (Lingsen)

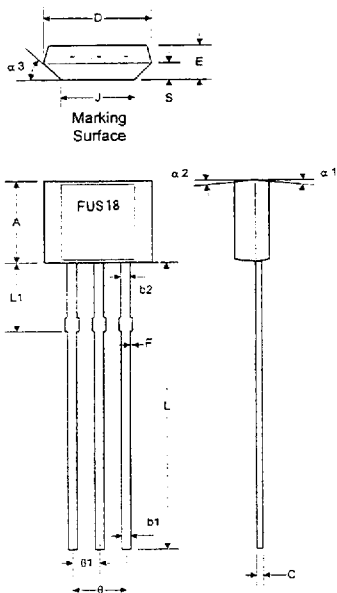

### 3 Lead SIP Package (AUK)

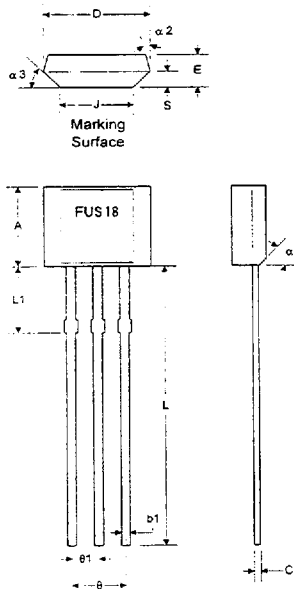

Symbol	Millimeters		
	Min	Typ	Max
$\alpha 1$		45°	
$\alpha 2$		5°	
$\alpha 3$			5°
A	2.80	3.00	3.20
B <sub>1</sub>	0.35	0.38	0.41
B <sub>2</sub>	0.43	0.46	0.48
C	0.35	0.38	0.41
D	3.90	4.10	4.30
E	1.40	1.50	1.60
F	0		0.20
$\theta$	2.51	2.54	2.57
$\theta 1$	1.24	1.27	1.30
L	10.0	10.5	11.0
L1	1.55	1.65	1.75
S	0.63	0.74	0.84

Symbol	Millimeters		
	Min	Typ	Max
$\alpha 1$		45°	
$\alpha 2$		45°	
$\alpha 3$		5°	
A	2.95	3.00	3.05
B <sub>1</sub>		0.42	
C		0.40	
D	0	4.30	
E	1.45	1.50	1.55
J	2.55	2.60	2.65
$\theta$		2.54	
$\theta 1$		1.27	
L	10.45	10.50	10.55
L1		2.16	
S		0.79	