

Power Transistor (- 60V, - 3A)

2SB1184 / 2SB1243 / 2SB1185

●Features

- 1) Low $V_{CE(sat)}$.
 $V_{CE(sat)} = -0.5V$ (Typ.)
 $(I_c / I_B = -2A / -0.2A)$
- 2) Complements the 2SD1760 / 2SD1864 / 2SD1762.

●Structure

Epitaxial planar type
 PNP silicon transistor

●External dimensions (Units: mm)

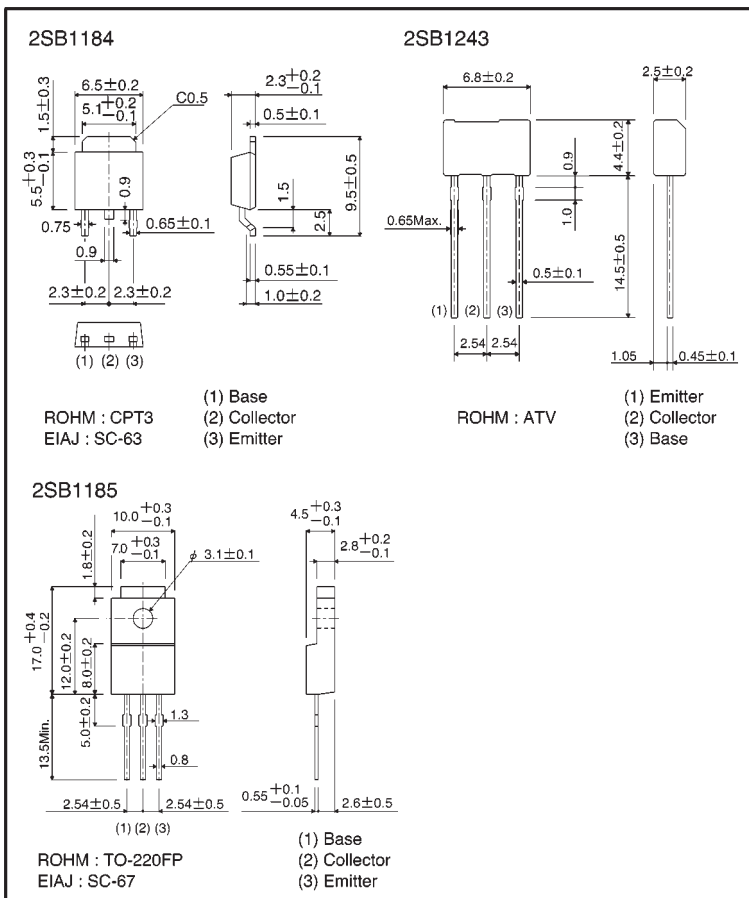

● Absolute maximum ratings (Ta = 25°C)

Parameter		Symbol	Limits	Unit
Collector-base voltage		V _{CB0}	-60	V
Collector-emitter voltage		V _{CE0}	-50	V
Emitter-base voltage		V _{EB0}	-5	V
Collector current		I _c	-3	A (DC)
		I _{cP}	-4.5	A (Pulse) *1
Collector power dissipation	2SB1184	P _c	1	W
			15	W (T _c =25°C)
	2SB1243		1	W *2
			2SB1185	
			25	W (T _c =25°C)
Junction temperature		T _j	150	°C
Storage temperature		T _{stg}	-55~+150	°C

*1 Single pulse, P_w=100ms*2 Printed circuit board, 1.7mm thick, collector copper plating 100mm² or larger.

● Electrical characteristics (Ta = 25°C)

Parameter		Symbol	Min.	Typ.	Max.	Unit	Conditions
Collector-base breakdown voltage		BV _{CB0}	-60	—	—	V	I _c =-50 μA
Collector-emitter breakdown voltage		BV _{CE0}	-50	—	—	V	I _c =-1mA
Emitter-base breakdown voltage		BV _{EB0}	-5	—	—	V	I _E =-50 μA
Collector cutoff current		I _{cBO}	—	—	-1	μA	V _{CB} =-40V
Emitter cutoff current		I _{EBO}	—	—	-1	μA	V _{EB} =-4V
Collector-emitter saturation voltage		V _{CE(sat)}	—	—	-1	V	I _c /I _B =-2A/-0.2A *
Base-emitter saturation voltage		V _{BE(sat)}	—	—	-1.5	V	I _c /I _B =-2A/-0.2A *
DC current transfer ratio	2SB1184, 2SB1243	h _{FE}	82	—	390	—	V _{CE} =-3V, I _c =-0.5A *
	2SB1185		60	—	320	—	
Transition frequency		f _T	—	70	—	MHz	V _{CE} =-5V, I _E =0.5A, f=30MHz
Output capacitance		C _{ob}	—	50	—	pF	V _{CB} =-10V, I _E =0A, f=1MHz

* Measured using pulse current.

● Packaging specifications and h_{FE}

Type	h _{FE}	Package	Taping		Bulk
		Code	TL	TV2	—
		Basic ordering unit (pieces)	2500	2500	200
2SB1184	PQR		○	—	—
2SB1243	PQR		—	○	—
2SB1185	DEF		—	—	○

h_{FE} values are classified as follows :

Item	D	E	F
h _{FE}	60~120	100~200	160~320

Item	P	Q	R
h _{FE}	82~180	120~270	180~390

● Electrical characteristic curves

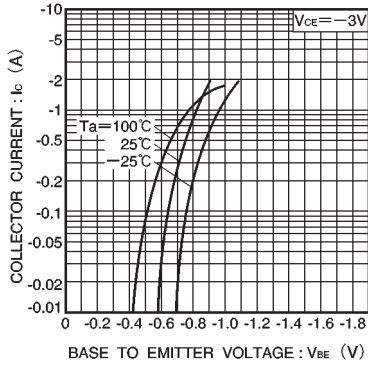

Fig.1 Grounded emitter propagation characteristics

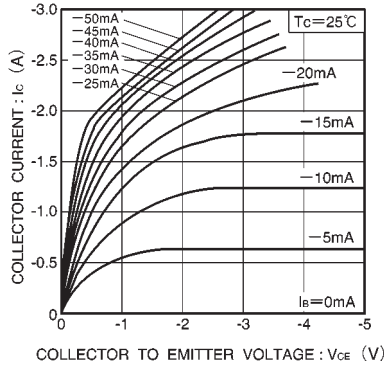

Fig.2 Grounded emitter output characteristics (I)

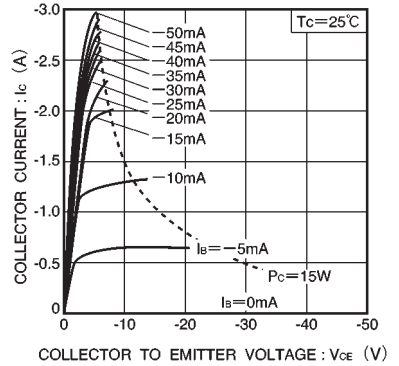

Fig.3 Grounded emitter output characteristics (II)

www.DataSheet4U.com

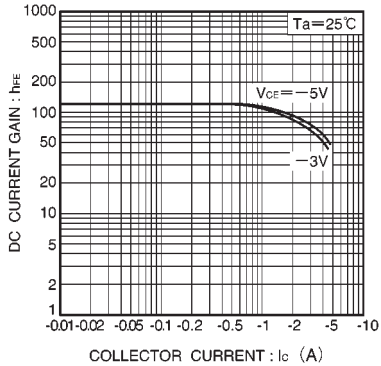

Fig.4 DC current gain vs. collector current (I)

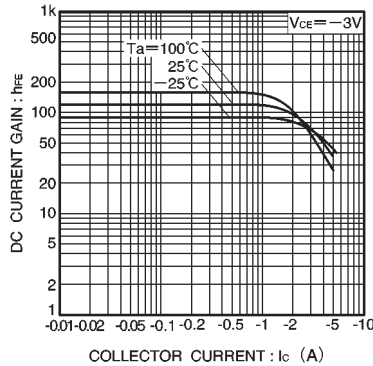

Fig.5 DC current gain vs. collector current (II)

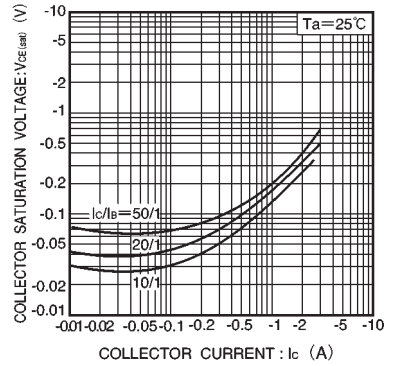

Fig.6 Collector-emitter saturation voltage vs. collector current

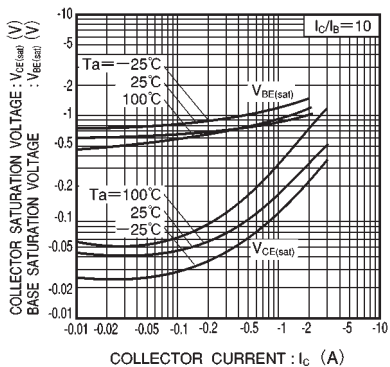

Fig.7 Collector-emitter saturation voltage vs. collector current
Base-emitter saturation voltage vs. collector current

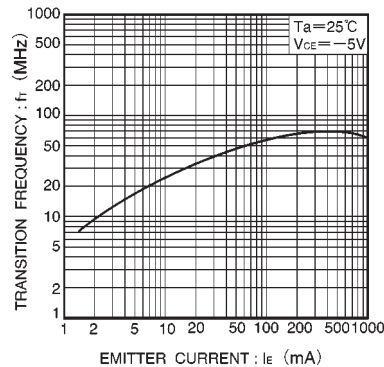

Fig.8 Gain bandwidth product vs. emitter current

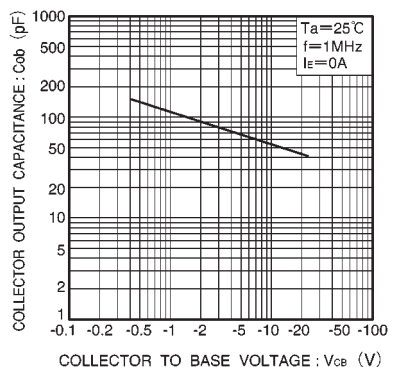

Fig.9 Collector output capacitance vs. collector base voltage

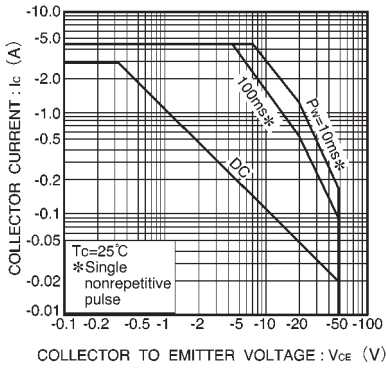

Fig.10 Safe operation area (2SB1184)

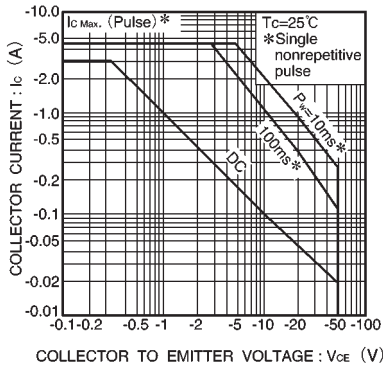

Fig.11 Safe operation area (2SB1243)

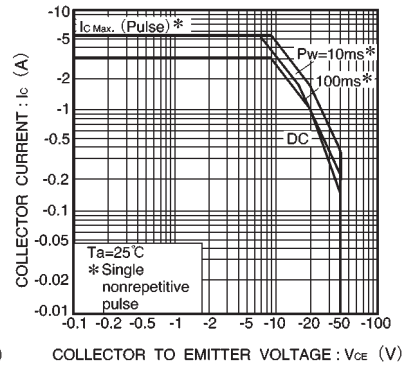

Fig.12 Safe operation area (2SB1185)

www.DataSheet4U.com